



Is Now Part of



ON Semiconductor®

To learn more about ON Semiconductor, please visit our website at
www.onsemi.com

Please note: As part of the Fairchild Semiconductor integration, some of the Fairchild orderable part numbers will need to change in order to meet ON Semiconductor's system requirements. Since the ON Semiconductor product management systems do not have the ability to manage part nomenclature that utilizes an underscore (_), the underscore (_) in the Fairchild part numbers will be changed to a dash (-). This document may contain device numbers with an underscore (_). Please check the ON Semiconductor website to verify the updated device numbers. The most current and up-to-date ordering information can be found at www.onsemi.com. Please email any questions regarding the system integration to Fairchild_questions@onsemi.com.

ON Semiconductor and the ON Semiconductor logo are trademarks of Semiconductor Components Industries, LLC dba ON Semiconductor or its subsidiaries in the United States and/or other countries. ON Semiconductor owns the rights to a number of patents, trademarks, copyrights, trade secrets, and other intellectual property. A listing of ON Semiconductor's product/patent coverage may be accessed at www.onsemi.com/site/pdf/Patent-Marking.pdf. ON Semiconductor reserves the right to make changes without further notice to any products herein. ON Semiconductor makes no warranty, representation or guarantee regarding the suitability of its products for any particular purpose, nor does ON Semiconductor assume any liability arising out of the application or use of any product or circuit, and specifically disclaims any and all liability, including without limitation special, consequential or incidental damages. Buyer is responsible for its products and applications using ON Semiconductor products, including compliance with all laws, regulations and safety requirements or standards, regardless of any support or applications information provided by ON Semiconductor. "Typical" parameters which may be provided in ON Semiconductor data sheets and/or specifications can and do vary in different applications and actual performance may vary over time. All operating parameters, including "Typicals" must be validated for each customer application by customer's technical experts. ON Semiconductor does not convey any license under its patent rights nor the rights of others. ON Semiconductor products are not designed, intended, or authorized for use as a critical component in life support systems or any FDA Class 3 medical devices or medical devices with a same or similar classification in a foreign jurisdiction or any devices intended for implantation in the human body. Should Buyer purchase or use ON Semiconductor products for any such unintended or unauthorized application, Buyer shall indemnify and hold ON Semiconductor and its officers, employees, subsidiaries, affiliates, and distributors harmless against all claims, costs, damages, and expenses, and reasonable attorney fees arising out of, directly or indirectly, any claim of personal injury or death associated with such unintended or unauthorized use, even if such claim alleges that ON Semiconductor was negligent regarding the design or manufacture of the part. ON Semiconductor is an Equal Opportunity/Affirmative Action Employer. This literature is subject to all applicable copyright laws and is not for resale in any manner.



September 2014

FOD8321

2.5A Output Current, Gate Drive Optocoupler in Optoplanar[®] Wide Body SOP 5-Pin

Features

- Fairchild's Optoplanar[®] Packaging Technology Provides Reliable and High-Voltage Insulation with Greater than 8 mm Creepage and Clearance Distance, and 0.5 mm Internal Insulation Distance While Still Offering a Compact Footprint
- 2.5 A Output Current Driving Capability for Medium-Power IGBT/MOSFET
 - P-Channel MOSFETs at Output Stage Enables Output Voltage Swing Close to Supply Rail
- 20 kV/ μ s Minimum Common Mode Rejection
- Wide Supply Voltage Range: 15 V to 30 V
- Fast Switching Speed Over Full Operating Temperature Range:
 - 500 ns Maximum Propagation Delay
 - 300 ns Maximum Pulse Width Distortion
- Under-Voltage Lockout (UVLO) with Hysteresis
- Extended Industrial Temperature Range: -40°C to 100°C
- Safety and Regulatory Approvals:
 - UL1577, 5,000 V_{RMS} for 1 Minute
 - DIN EN/IEC60747-5-5, 1,414 V Peak Working Insulation Voltage

Applications

- AC and Brushless DC Motor Drives
- Industrial Inverter
- Uninterruptible Power Supply
- Induction Heating
- Isolated IGBT/Power MOSFET Gate Drive

Related Resources

- [FOD3120, High Noise Immunity, 2.5 A Output Current, Gate Drive Optocoupler Datasheet](#)
- www.fairchildsemi.com/products/opto/

Description

The FOD8321 is a 2.5 A output current gate drive optocoupler, capable of driving medium-power IGBT/MOSFETs. It is ideally suited for fast-switching driving of power IGBT and MOSFET used in motor-control inverter applications and high-performance power systems.

The FOD8321 utilizes Fairchild's Optoplanar[®] coplanar packaging technology and optimized IC design to achieve reliable high-insulation voltage and high-noise immunity.

It consists of an Aluminum Gallium Arsenide (AlGaAs) Light-Emitting Diode (LED) optically coupled to an integrated circuit with a high-speed driver for push-pull MOSFET output stage. The device is housed in a wide body, 5-pin, small-outline, plastic package.

Functional Schematic

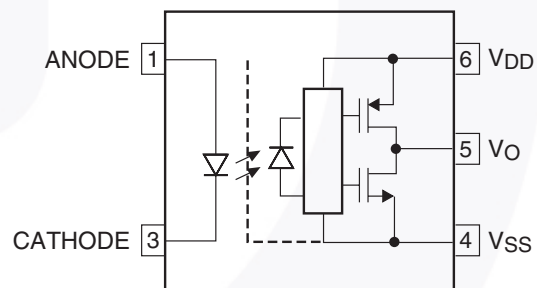

Figure 1. Schematic

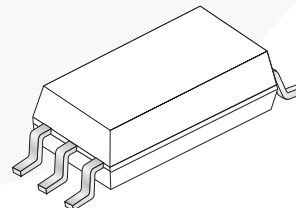

Figure 2. Package Outline

FOD8321 — 2.5A Output Current, Gate Drive Optocoupler in Optoplanar[®] Wide Body SOP 5-Pin

Truth Table

LED	$V_{DD} - V_{SS}$ “Positive Going” (Turn-on)	$V_{DD} - V_{SS}$ “Positive Going” (Turn-off)	V_O
Off	0 V to 30 V	0 V to 30 V	LOW
On	0 V to 11.5 V	0 V to 10 V	LOW
On	11.5 V to 14.5 V	10 V to 13 V	Transition
On	14.5 V to 30 V	13 V to 30 V	HIGH

Pin Configuration

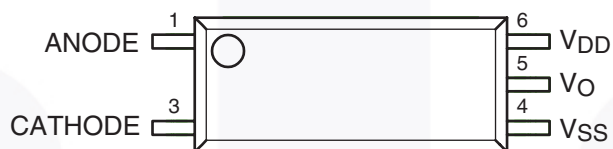

Figure 3. Pin Configuration

Pin Definitions

Pin #	Name	Description
1	Anode	LED Anode
3	Cathode	LED Cathode
4	V_{SS}	Negative Supply Voltage
5	V_O	Output Voltage
6	V_{DD}	Positive Supply Voltage

Safety and Insulation Ratings

As per DIN EN/IEC60747-5-5, this optocoupler is suitable for “safe electrical insulation” only within the safety limit data. Compliance with the safety ratings shall be ensured by means of protective circuits.

Symbol	Parameter	Min.	Typ.	Max.	Unit
	Installation Classifications per DIN VDE 0110/1.89 Table 1				
	For Rated Mains Voltage < 150 V _{RMS}		I-IV		
	For Rated Mains Voltage < 300 V _{RMS}		I-IV		
	For Rated Mains Voltage < 450 V _{RMS}		I-III		
	For Rated Mains Voltage < 600 V _{RMS}		I-III		
	Climatic Classification		40/100/21		
	Pollution Degree (DIN VDE 0110/1.89)		2		
CTI	Comparative Tracking Index	175			
V _{PR}	Input-to-Output Test Voltage, Method b, V _{IORM} × 1.875 = V _{PR} , 100% Production Test with t _m = 1 s, Partial Discharge < 5 pC	2651			V _{peak}
	Input-to-Output Test Voltage, Method a, V _{IORM} × 1.6 = V _{PR} , Type and Sample Test with t _m = 10 s, Partial Discharge < 5 pC	2262			V _{peak}
V _{IORM}	Maximum Working Insulation Voltage	1414			V _{peak}
V _{IOTM}	Highest Allowable Over Voltage	8000			V _{peak}
	External Creepage	8.0			mm
	External Clearance	8.0			mm
	Insulation Thickness	0.5			mm
	Safety Limit Values – Maximum Values Allowed in the Event of a Failure				
T _S	Case Temperature	150			°C
I _{S,INPUT}	Input Current	200			mA
P _{S,OUTPUT}	Output Power	600			mW
R _{IO}	Insulation Resistance at T _S , V _{IO} = 500 V	10 ⁹			Ω

Absolute Maximum Ratings

Stresses exceeding the absolute maximum ratings may damage the device. The device may not function or be operable above the recommended operating conditions and stressing the parts to these levels is not recommended. In addition, extended exposure to stresses above the recommended operating conditions may affect device reliability. The absolute maximum ratings are stress ratings only. $T_A = 25^\circ\text{C}$ unless otherwise specified.

Symbol	Parameter	Value	Units
T_{STG}	Storage Temperature	-40 to +125	$^\circ\text{C}$
T_{OPR}	Operating Temperature	-40 to +100	$^\circ\text{C}$
T_{J}	Junction Temperature	-40 to +125	$^\circ\text{C}$
T_{SOL}	Lead Solder Temperature <i>Refer to Reflow Temperature Profile on page 15.</i>	260 for 10 s	$^\circ\text{C}$
$I_{\text{F(AVG)}}$	Average Input Current	25	mA
F	Operating Frequency	50	kHz
V_{R}	Reverse Input Voltage	5.0	V
$I_{\text{O(PEAK)}}$	Peak Output Current ⁽¹⁾	3.0	A
V_{DD}	Supply Voltage	0 to 35	V
$V_{\text{O(PEAK)}}$	Peak Output Voltage	0 to V_{DD}	V
$t_{\text{R(IN)}}$, $t_{\text{F(IN)}}$	Input Signal Rise and Fall Time	500	ns
PD_{I}	Input Power Dissipation ⁽²⁾⁽⁴⁾	45	mW
PD_{O}	Output Power Dissipation ⁽³⁾⁽⁴⁾	500	mW

Notes:

1. Maximum pulse width = 10 μs , maximum duty cycle = 0.2%.
2. No derating required across operating temperature range.
3. Derate linearly from 25 $^\circ\text{C}$ at a rate of 5.2 mW/ $^\circ\text{C}$
4. Functional operation under these conditions is not implied. Permanent damage may occur if the device is subjected to conditions outside these ratings.

Recommended Operating Conditions

The Recommended Operating Conditions table defines the conditions for actual device operation. Recommended operating conditions are specified to ensure optimal performance to the datasheet specifications. Fairchild does not recommend exceeding them or designing to absolute maximum ratings.

Symbol	Parameter	Min.	Max.	Unit
T_{A}	Ambient Operating Temperature	-40	100	$^\circ\text{C}$
$V_{\text{DD}} - V_{\text{SS}}$	Supply Voltage	16	30	V
$I_{\text{F(ON)}}$	Input Current (ON)	10	16	mA
$V_{\text{F(OFF)}}$	Input Voltage (OFF)	0	0.8	V

Isolation Characteristics

Apply over all recommended conditions, typical value is measured at $T_A = 25^\circ\text{C}$

Symbol	Parameter	Conditions	Min.	Typ.	Max.	Units
V_{ISO}	Input-Output Isolation Voltage	$T_A = 25^\circ\text{C}$, R.H. < 50%, $t = 60\text{ s}$, $I_{I-O} \leq 20\ \mu\text{A}$, $50\text{ Hz}^{(5)(6)}$	5,000			V_{RMS}
R_{ISO}	Isolation Resistance	$V_{I-O} = 500\text{ V}^{(5)}$		10^{11}		Ω
C_{ISO}	Isolation Capacitance	$V_{I-O} = 0\text{ V}$, Frequency = $1.0\text{ MHz}^{(6)}$		1		pF

Notes:

- Device is considered a two terminal device: pins 1 and 3 are shorted together and pins 4, 5 and 6 are shorted together.
- $5,000\text{ VAC}_{RMS}$ for 1 minute duration is equivalent to $6,000\text{ VAC}_{RMS}$ for 1 second duration.

Electrical Characteristics

Apply over all recommended conditions, typical value is measured at $V_{DD} = 30\text{ V}$, $V_{SS} = \text{Ground}$, $T_A = 25^\circ\text{C}$ unless otherwise specified.

Symbol	Parameter	Conditions	Min.	Typ.	Max.	Units	Figure
V_F	Input Forward Voltage		1.1	1.5	1.8	V	19
$\Delta(V_F / T_A)$	Temperature Coefficient of Forward Voltage	$I_F = 10\text{ mA}$		-1.8		mV/°C	
BV_R	Input Reverse Breakdown Voltage	$I_R = 10\ \mu\text{A}$	5			V	
C_{IN}	Input Capacitance	$f = 1\text{ MHz}$, $V_F = 0\text{ V}$		60		pF	
I_{OH}	High Level Output Current ⁽¹⁾	$V_{OH} = V_{DD} - 3\text{ V}$	1.0	2.0	2.5	A	4, 6
		$V_{OH} = V_{DD} - 6\text{ V}$	2.0		2.5	A	4, 6, 22
I_{OL}	Low Level Output Current ⁽¹⁾	$V_{OL} = V_{SS} + 3\text{ V}$	1.0	2.0	2.5	A	7, 9
		$V_{OL} = V_{SS} + 6\text{ V}$	2.0		2.5	A	7, 9, 21
V_{OH}	High Level Output Voltage ⁽⁷⁾⁽⁸⁾	$I_F = 10\text{ mA}$, $I_O = -2.5\text{ A}$	$V_{DD} - 6.25$	$V_{DD} - 2.5$		V	4
		$I_F = 10\text{ mA}$, $I_O = -100\text{ mA}$	$V_{DD} - 0.5$	$V_{DD} - 0.1$		V	4, 5, 23
V_{OL}	Low Level Output Voltage ⁽⁷⁾⁽⁸⁾	$I_F = 10\text{ mA}$, $I_O = 2.5\text{ A}$		$V_{SS} + 2.5$	$V_{SS} + 6.25$	V	7
		$I_F = 0\text{ mA}$, $I_O = 100\text{ mA}$		$V_{SS} + 0.1$	$V_{SS} + 0.5$	V	8, 24
I_{DDH}	High Level Supply Current	V_O Open, $I_F = 10$ to 16 mA		2.9	5	mA	10, 11, 25
I_{DDL}	Low Level Supply Current	V_O Open, $V_F = 0$ to 0.8 V		2.8	5	mA	10, 11, 26
I_{FLH}	Threshold Input Current Low to High	$I_O = 0\text{ mA}$, $V_O > 5\text{ V}$		2.4	7.5	mA	12, 18, 27
V_{FHL}	Threshold Input Voltage High to Low	$I_O = 0\text{ mA}$, $V_O < 5\text{ V}$	0.8			V	28
V_{UVLO+}	UnderVoltage Lockout Threshold	$I_F = 10\text{ mA}$, $V_O > 5\text{ V}$	11.5	12.7	14.5	V	20, 29
V_{UVLO-}		$I_F = 10\text{ mA}$, $V_O < 5\text{ V}$	10.0	11.2	13.0	V	20, 29
$UVLO_{HYS}$	UnderVoltage Lockout Threshold Hysteresis			1.5		V	

Notes:

- In this test, V_{OH} is measured with a dc load current of 100 mA. When driving capacitive load V_{OH} will approach V_{DD} as I_{OH} approaches 0 A.
- Maximum pulse width = 1 ms, maximum duty cycle = 20%.

Switching Characteristics

Apply over all recommended conditions, typical value is measured at $V_{DD} = 30V$, $V_{SS} = \text{Ground}$, $T_A = 25^\circ\text{C}$ unless otherwise specified.

Symbol	Parameter	Conditions	Min.	Typ.	Max.	Units	Figure	
t_{PHL}	Propagation Delay Time to Logic Low Output ⁽⁹⁾	$I_F = 10 \text{ mA to } 16 \text{ mA}$, $R_g = 10 \Omega$, $C_g = 10 \text{ nF}$, $f = 10 \text{ kHz}$, Duty Cycle = 50%	100	285	500	ns	13, 14, 15, 16, 17, 30	
t_{PLH}	Propagation Delay Time to Logic High Output ⁽¹⁰⁾		100	260	500	ns	13, 14, 15, 16, 17, 20	
PWD	Pulse Width Distortion ⁽¹¹⁾ $ t_{PHL} - t_{PLH} $				25	300	ns	
PDD (Skew)	Propagation Delay Difference Between Any Two Parts ⁽¹²⁾			-350		350		
t_R	Output Rise Time (10% to 90%)				60		ns	30
t_F	Output Fall Time (90% to 10%)				60		ns	30
$t_{ULVO \text{ ON}}$	ULVO Turn On Delay	$I_F = 10 \text{ mA}$, $V_O > 5 \text{ V}$		0.8		μs		
$t_{ULVO \text{ OFF}}$	ULVO Turn Off Delay	$I_F = 10 \text{ mA}$, $V_O < 5 \text{ V}$		0.4		μs		
$ CM_H $	Common Mode Transient Immunity at Output High	$T_A = 25^\circ\text{C}$, $V_{DD} = 30 \text{ V}$, $I_F = 10 \text{ mA to } 16 \text{ mA}$, $V_{CM} = 2000 \text{ V}^{(13)}$	20	50		$\text{kV}/\mu\text{s}$	31	
$ CM_L $	Common Mode Transient Immunity at Output Low	$T_A = 25^\circ\text{C}$, $V_{DD} = 30 \text{ V}$, $V_F = 0 \text{ V}$, $V_{CM} = 2000 \text{ V}^{(14)}$	20	50		$\text{kV}/\mu\text{s}$	31	

Notes:

- Propagation delay t_{PHL} is measured from the 50% level on the falling edge of the input pulse to the 50% level of the falling edge of the V_O signal.
- Propagation delay t_{PLH} is measured from the 50% level on the rising edge of the input pulse to the 50% level of the rising edge of the V_O signal.
- PWD is defined as $|t_{PHL} - t_{PLH}|$ for any given device.
- The difference between t_{PHL} and t_{PLH} between any two FOD8321 parts under the same operating conditions, with equal loads.
- Common mode transient immunity at output high is the maximum tolerable negative dV_{cm}/dt on the trailing edge of the common mode impulse signal, V_{CM} , to ensure that the output remains high (i.e., $V_O > 15.0 \text{ V}$).
- Common mode transient immunity at output low is the maximum tolerable positive dV_{cm}/dt on the leading edge of the common pulse signal, V_{CM} , to ensure that the output remains low (i.e., $V_O < 1.0 \text{ V}$).

Typical Performance Characteristics

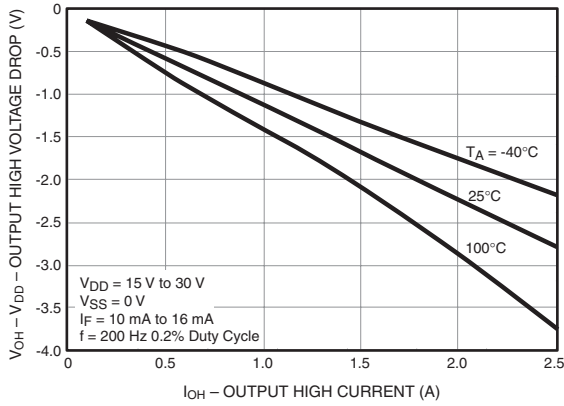

Figure 4. Output High Voltage Drop vs. Output High Current

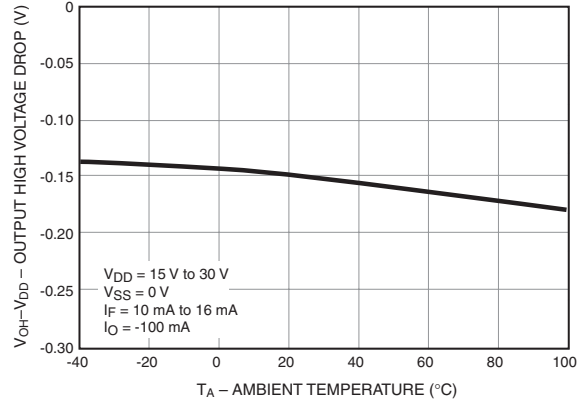

Figure 5. Output High Voltage Drop vs. Ambient Temperature

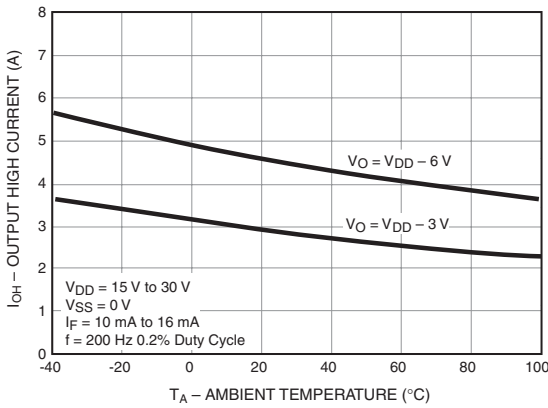

Figure 6. Output High Current vs. Ambient Temperature

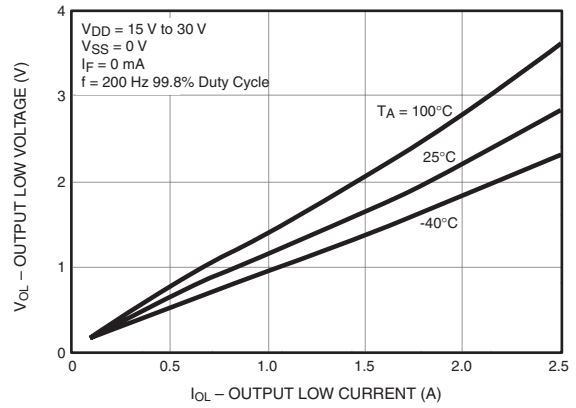

Figure 7. Output Low Voltage vs. Output Low Current

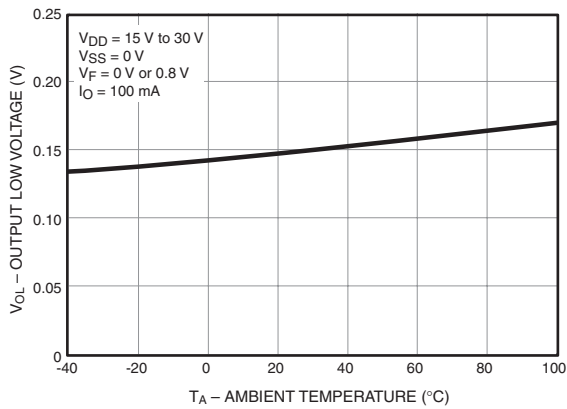

Figure 8. Output Low Voltage vs. Ambient Temperature

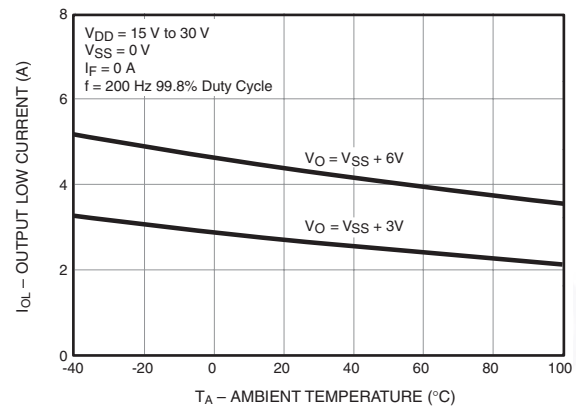

Figure 9. Output Low Current vs. Ambient Temperature

Typical Performance Characteristics (Continued)

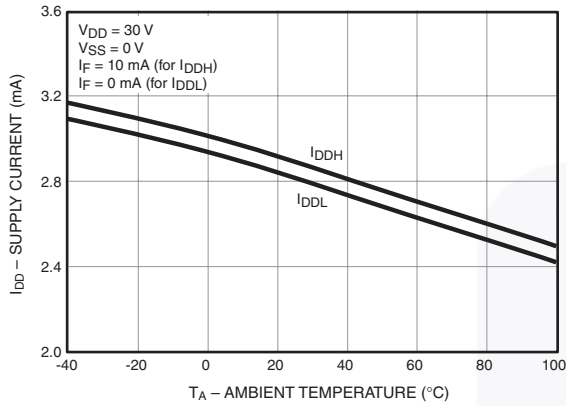

Figure 10. Supply Current vs. Ambient Temperature

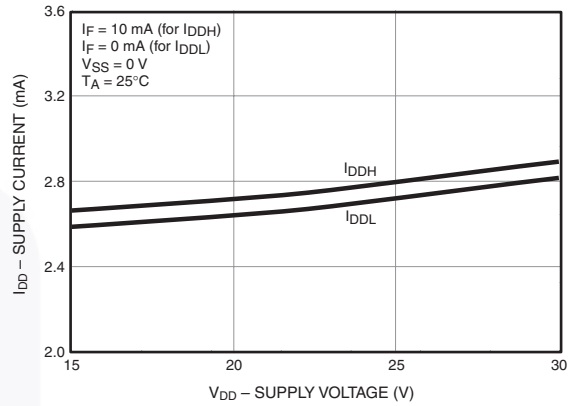

Figure 11. Supply Current vs. Supply Voltage

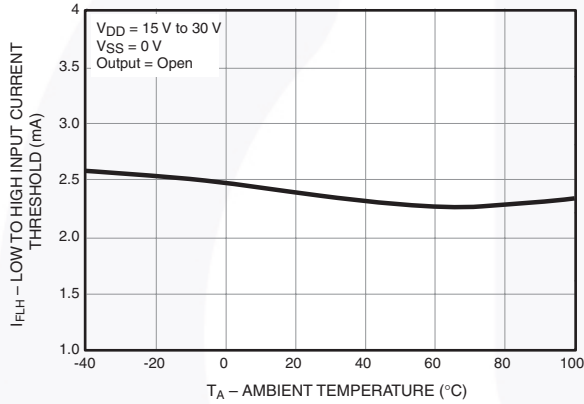

Figure 12. Low to High Input Current Threshold vs. Ambient Temperature

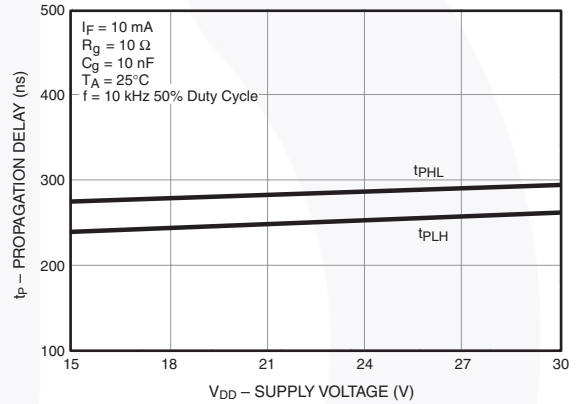

Figure 13. Propagation Delay vs. Supply Voltage

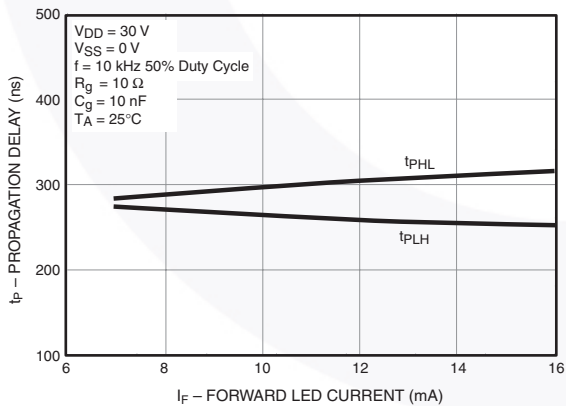

Figure 14. Propagation Delay vs. LED Forward Current

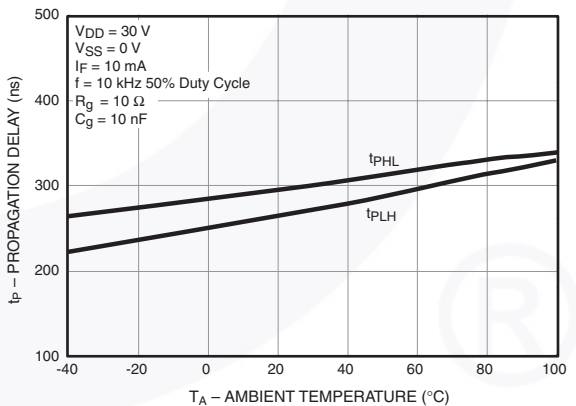

Figure 15. Propagation Delay vs. Ambient Temperature

Typical Performance Characteristics (Continued)

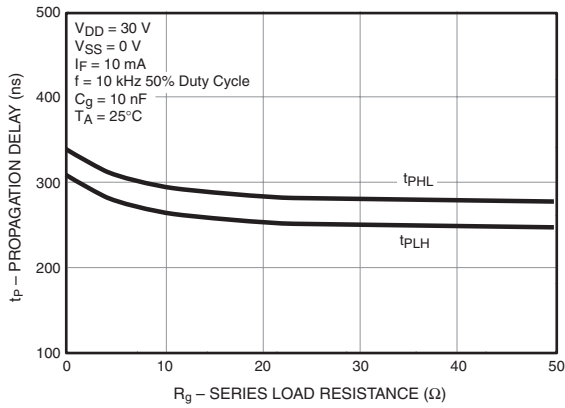

Figure 16. Propagation Delay vs. Series Load Resistance

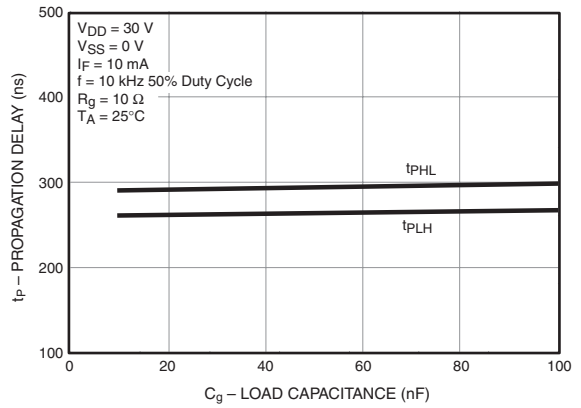

Figure 17. Propagation Delay vs. Load Capacitance

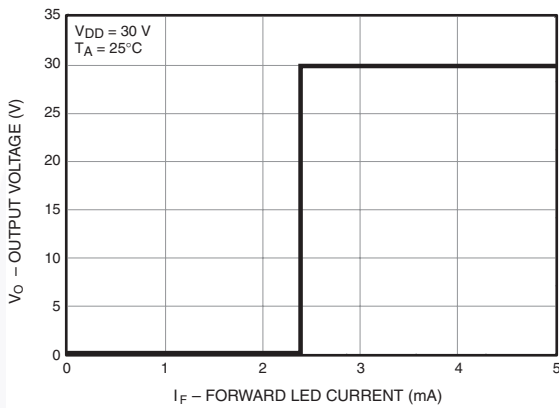

Figure 18. Transfer Characteristics

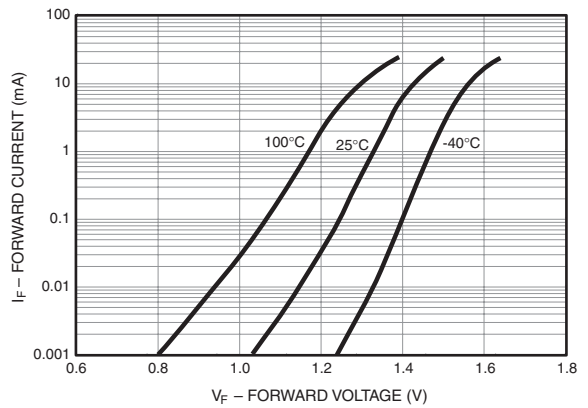

Figure 19. Input Forward Current vs. Forward Voltage

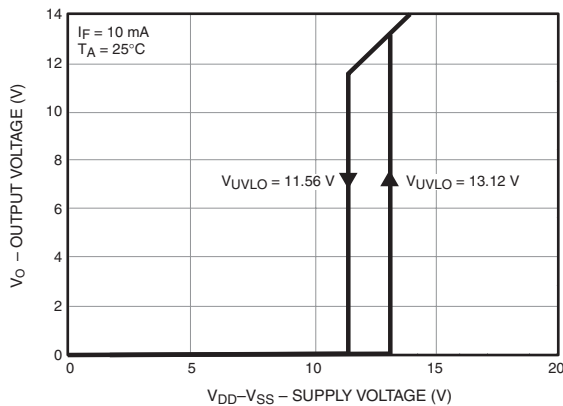

Figure 20. Under Voltage Lockout

Test Circuit



Figure 21. I_{OL} Test Circuit

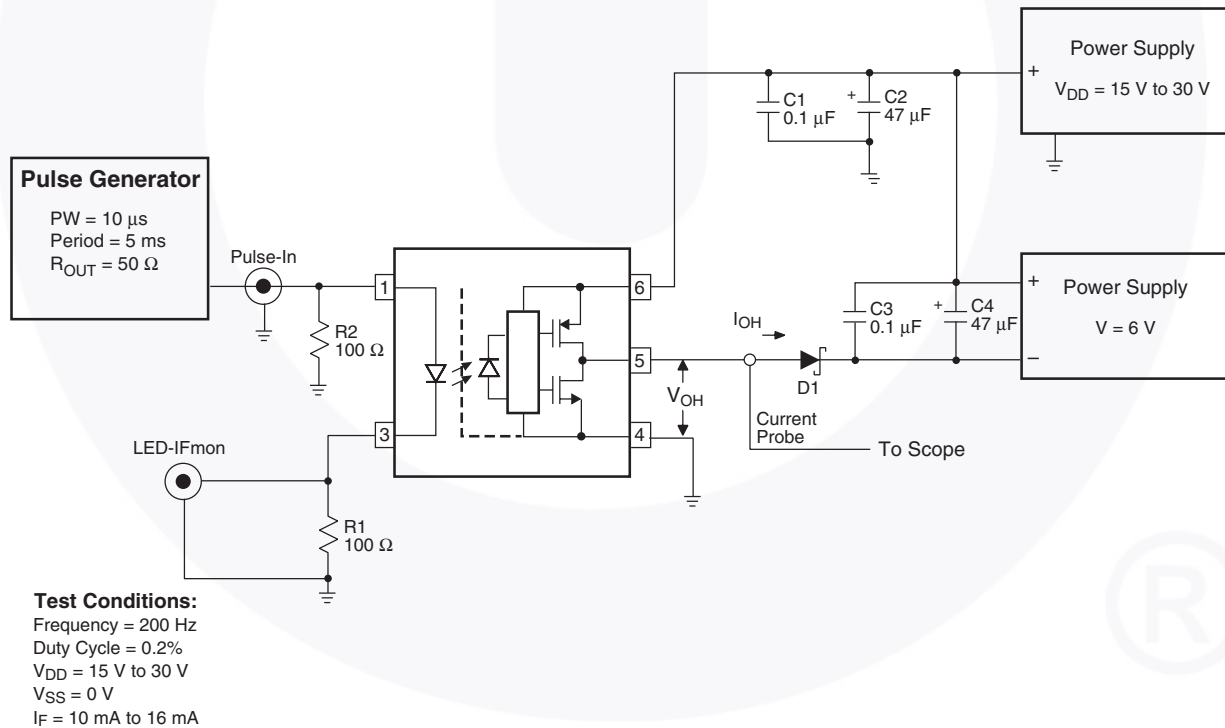

Figure 22. I_{OH} Test Circuit

Test Circuit (Continued)

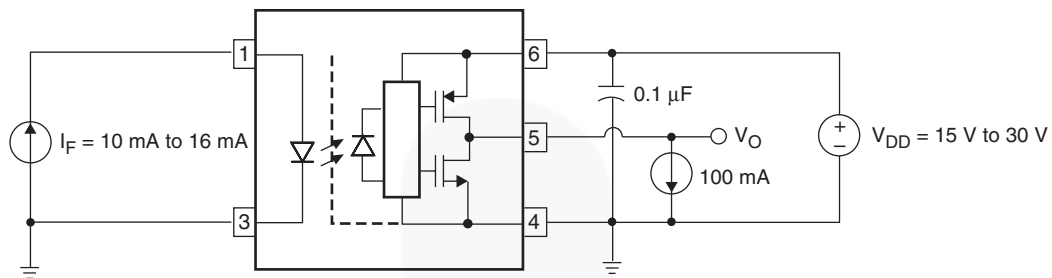

Figure 23. V_{OH} Test Circuit

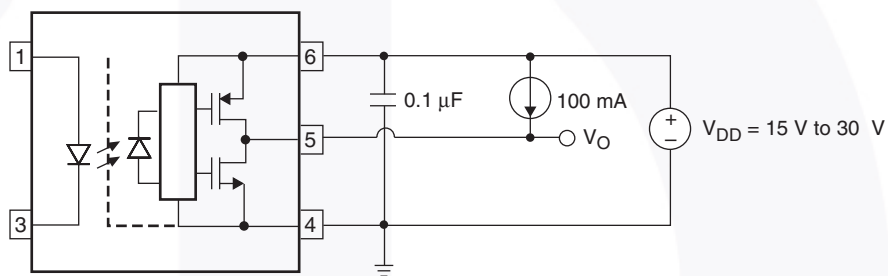

Figure 24. V_{OL} Test Circuit



Test Circuit (Continued)

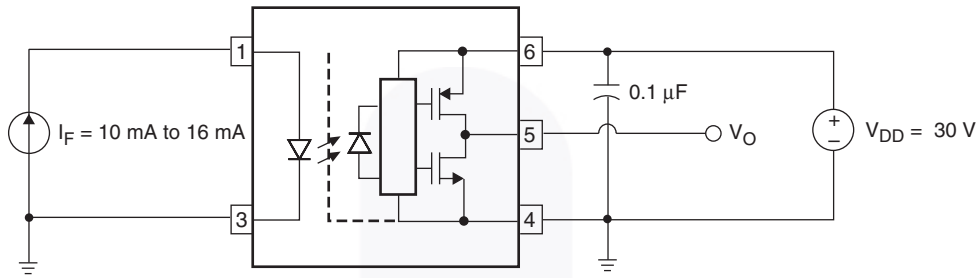

Figure 25. I_{DDH} Test Circuit

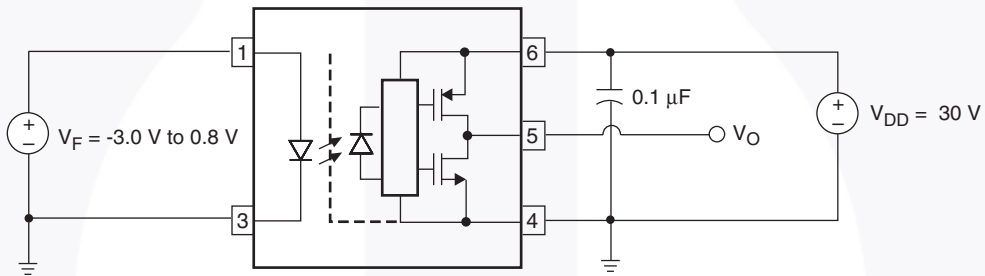

Figure 26. I_{DDL} Test Circuit

Test Circuit (Continued)

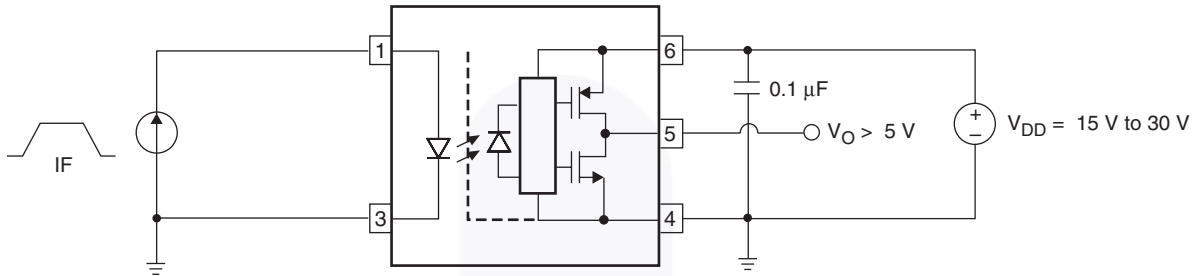

Figure 27. I_{FLH} Test Circuit

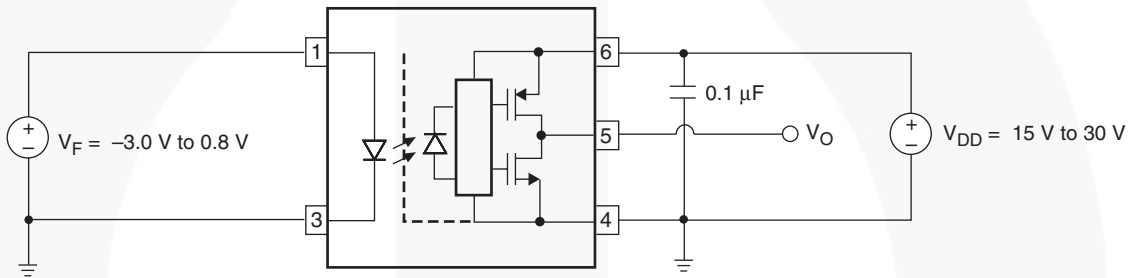

Figure 28. V_{FHL} Test Circuit

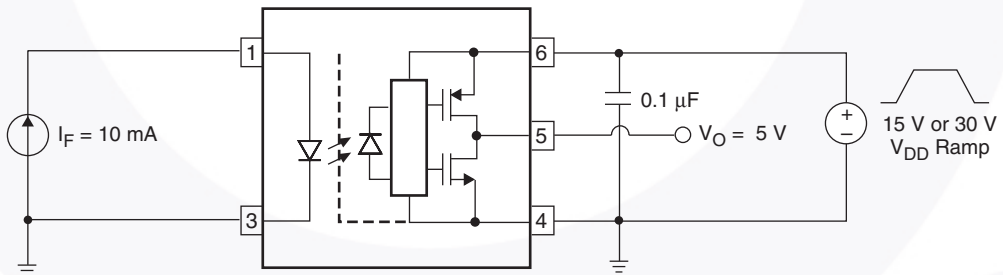

Figure 29. UVLO Test Circuit

Test Circuit (Continued)

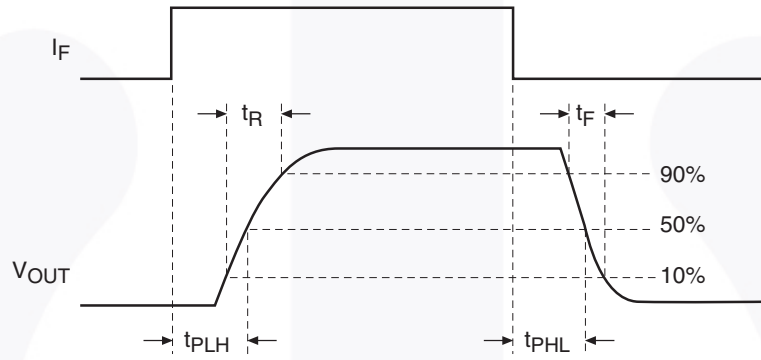
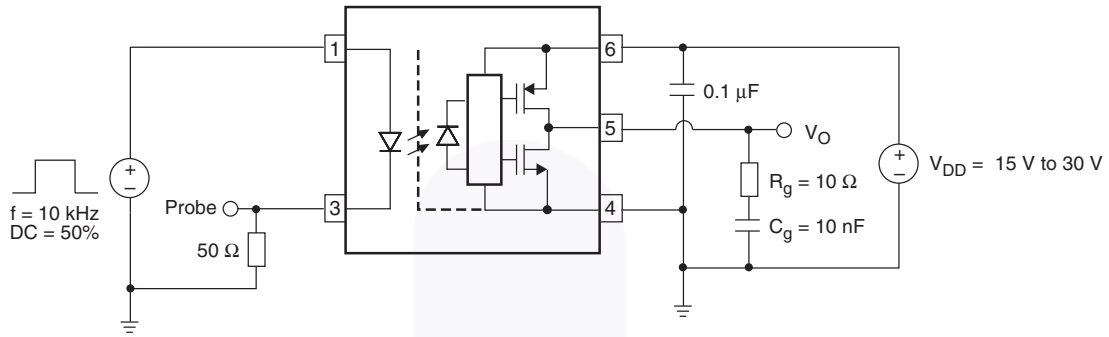

Figure 30. t_{PLH} , t_{PLH} , t_R and t_F Test Circuit and Waveforms

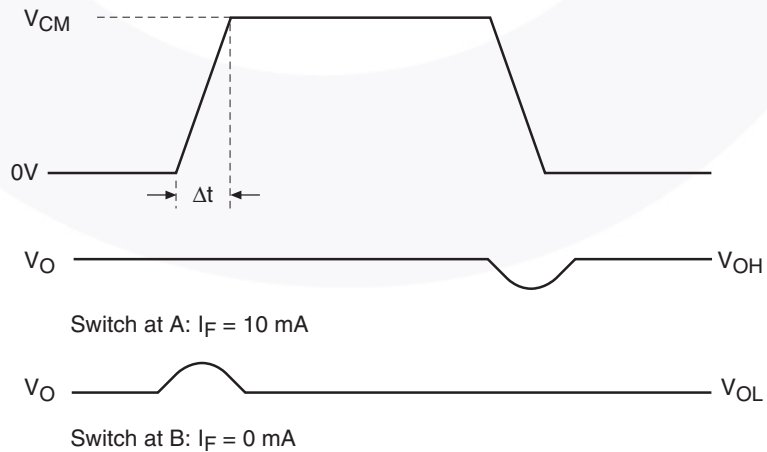
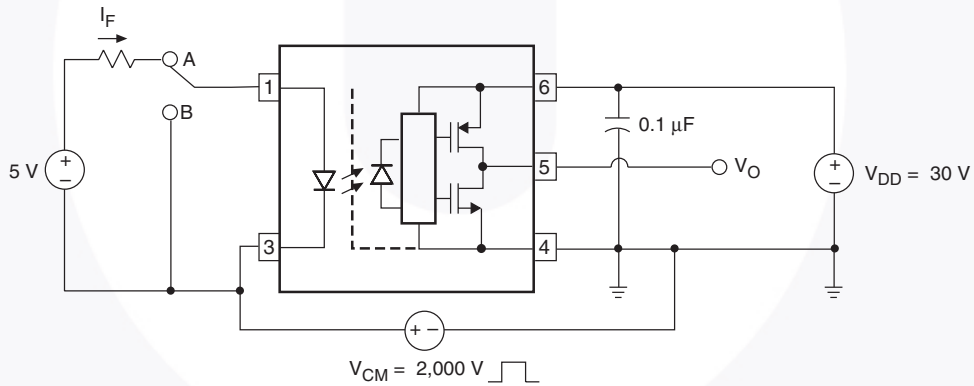
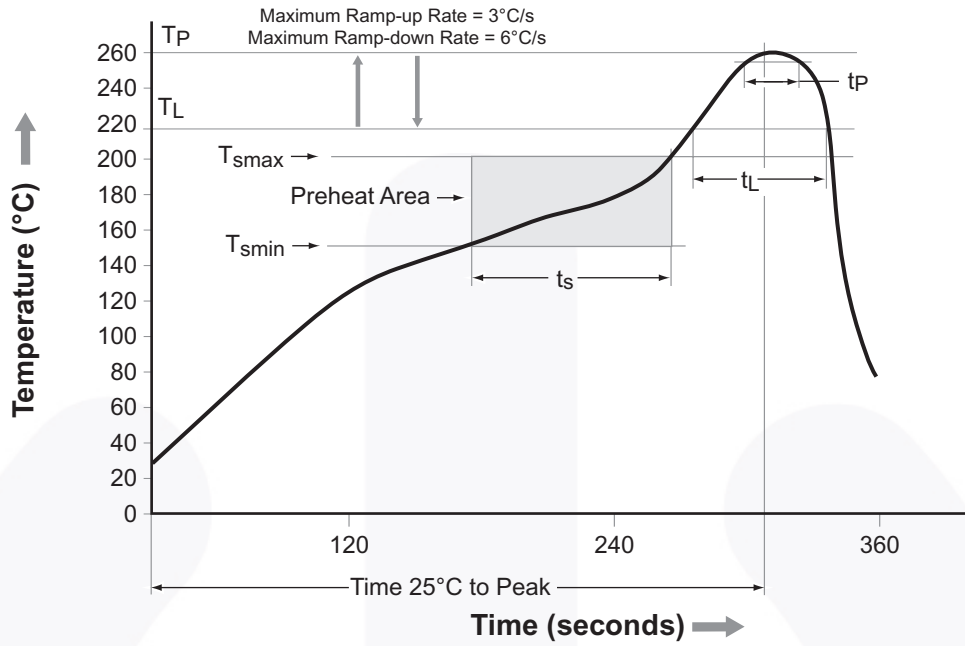

Figure 31. CMR Test Circuit and Waveforms

Reflow Profile



Profile Feature	Pb-Free Assembly Profile
Temperature Minimum (T_{smin})	150°C
Temperature Maximum (T_{smax})	200°C
Time (t_s) from (T_{smin} to T_{smax})	60 s to 120 s
Ramp-up Rate (t_L to t_P)	3°C/second maximum
Liquidous Temperature (T_L)	217°C
Time (t_L) Maintained Above (T_L)	60 s to 150 s
Peak Body Package Temperature	260°C +0°C / -5°C
Time (t_p) within 5°C of 260°C	30 s
Ramp-Down Rate (T_P to T_L)	6°C/s maximum
Time 25°C to Peak Temperature	8 minutes maximum

Figure 32. Reflow Profile

Ordering Information

Part Number	Package	Packing Method
FOD8321	Wide Body SOP 5-Pin	Tube (100 units per tube)
FOD8321R2	Wide Body SOP 5-Pin	Tape and Reel (1,000 units per reel)
FOD8321V	Wide Body SOP 5-Pin, DIN EN/IEC60747-5-5 Option	Tube (100 units per tube)
FOD8321R2V	Wide Body SOP 5-Pin, DIN EN/ IEC60747-5-5 Option	Tape and Reel (1,000 units per reel)

 All packages are lead free per JEDEC: J-STD-020B standard.

Marking Information

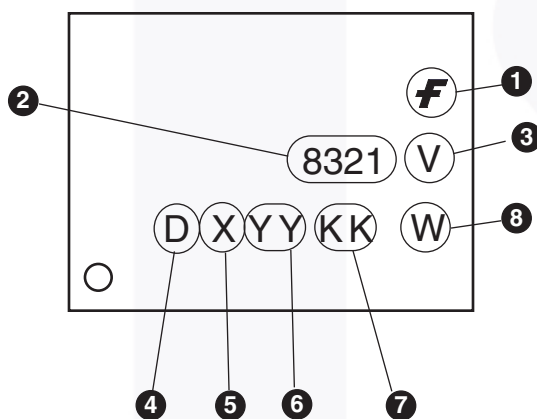

Definitions	
1	Fairchild logo
2	Device number, e.g., '8321' for FOD8321
3	DIN EN/IEC60747-5-5 Option (only appears on component ordered with this option)
4	Plant code, e.g., 'D'
5	Last digit year code, e.g., 'C' for 2012
6	Two digit work week ranging from '01' to '53'
7	Lot traceability code
8	Package assembly code, W

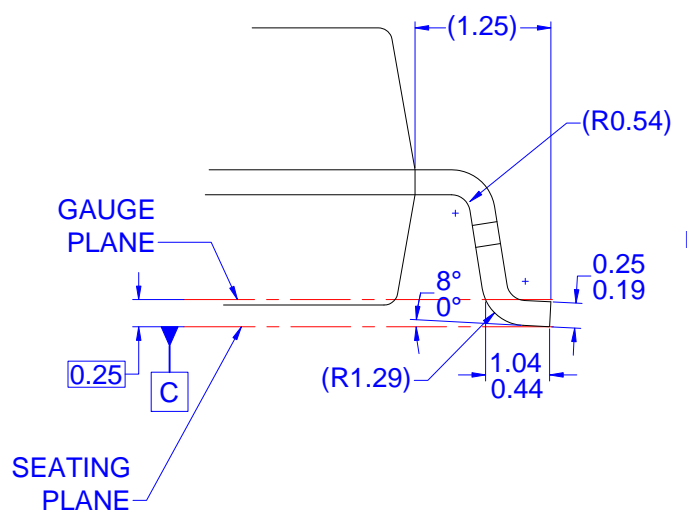
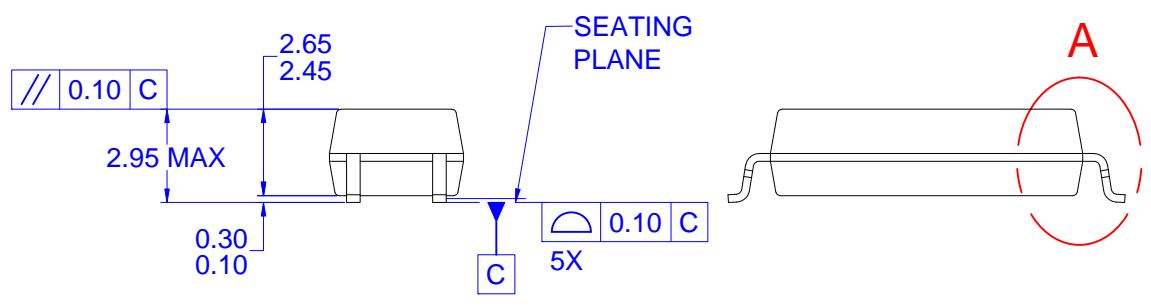
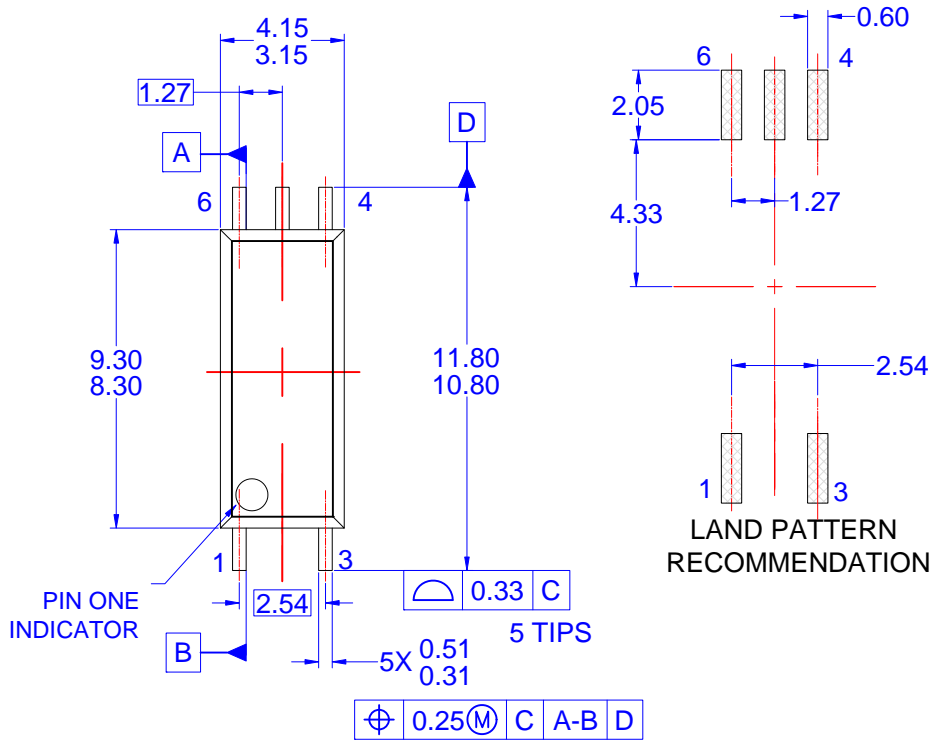

DETAIL A
SCALE: 3.2:1

- NOTES: UNLESS OTHERWISE SPECIFIED
- A) THIS PACKAGE DOES NOT CONFORM TO ANY STANDARD.
 - B) ALL DIMENSIONS ARE IN MILLIMETERS.
 - C) DIMENSIONS ARE EXCLUSIVE OF BURRS, MOLD FLASH AND TIE BAR PROTRUSIONS
 - D) DRAWING CONFORMS TO ASME Y14.5M-1994
 - E) DRAWING FILE NAME: MKT-M05BREV2

ON Semiconductor and  are trademarks of Semiconductor Components Industries, LLC dba ON Semiconductor or its subsidiaries in the United States and/or other countries. ON Semiconductor owns the rights to a number of patents, trademarks, copyrights, trade secrets, and other intellectual property. A listing of ON Semiconductor's product/patent coverage may be accessed at www.onsemi.com/site/pdf/Patent-Marking.pdf. ON Semiconductor reserves the right to make changes without further notice to any products herein. ON Semiconductor makes no warranty, representation or guarantee regarding the suitability of its products for any particular purpose, nor does ON Semiconductor assume any liability arising out of the application or use of any product or circuit, and specifically disclaims any and all liability, including without limitation special, consequential or incidental damages. Buyer is responsible for its products and applications using ON Semiconductor products, including compliance with all laws, regulations and safety requirements or standards, regardless of any support or applications information provided by ON Semiconductor. "Typical" parameters which may be provided in ON Semiconductor data sheets and/or specifications can and do vary in different applications and actual performance may vary over time. All operating parameters, including "Typicals" must be validated for each customer application by customer's technical experts. ON Semiconductor does not convey any license under its patent rights nor the rights of others. ON Semiconductor products are not designed, intended, or authorized for use as a critical component in life support systems or any FDA Class 3 medical devices or medical devices with a same or similar classification in a foreign jurisdiction or any devices intended for implantation in the human body. Should Buyer purchase or use ON Semiconductor products for any such unintended or unauthorized application, Buyer shall indemnify and hold ON Semiconductor and its officers, employees, subsidiaries, affiliates, and distributors harmless against all claims, costs, damages, and expenses, and reasonable attorney fees arising out of, directly or indirectly, any claim of personal injury or death associated with such unintended or unauthorized use, even if such claim alleges that ON Semiconductor was negligent regarding the design or manufacture of the part. ON Semiconductor is an Equal Opportunity/Affirmative Action Employer. This literature is subject to all applicable copyright laws and is not for resale in any manner.

PUBLICATION ORDERING INFORMATION

LITERATURE FULFILLMENT:

Literature Distribution Center for ON Semiconductor
19521 E. 32nd Pkwy, Aurora, Colorado 80011 USA
Phone: 303-675-2175 or 800-344-3860 Toll Free USA/Canada
Fax: 303-675-2176 or 800-344-3867 Toll Free USA/Canada
Email: orderlit@onsemi.com

N. American Technical Support: 800-282-9855 Toll Free
USA/Canada
Europe, Middle East and Africa Technical Support:
Phone: 421 33 790 2910
Japan Customer Focus Center
Phone: 81-3-5817-1050

ON Semiconductor Website: www.onsemi.com
Order Literature: <http://www.onsemi.com/orderlit>
For additional information, please contact your local
Sales Representative