

# 1SS400

## Silicon Epitaxial Planar Switching Diode

for high speed switching application

### Features

- Extremely small surface mounting type
- High reliability

### PINNING

PIN	DESCRIPTION
1	Cathode
2	Anode

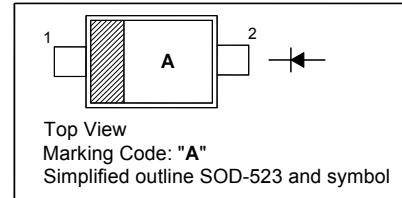

### Absolute Maximum Ratings ( $T_a = 25\text{ }^\circ\text{C}$ )

Parameter	Symbol	Value	Unit
Peak Reverse Voltage	$V_{RM}$	90	V
Reverse Voltage	$V_R$	80	V
Average Rectified Forward Current	$I_{F(AV)}$	100	mA
Peak Forward Current	$I_{FM}$	225	mA
Non-repetitive Peak Forward Surge Current (at $t = 1\text{ s}$ )	$I_{FSM}$	500	mA
Junction Temperature	$T_j$	150	$^\circ\text{C}$
Storage Temperature Range	$T_{stg}$	- 55 to + 150	$^\circ\text{C}$

### Characteristics at $T_a = 25\text{ }^\circ\text{C}$

Parameter	Symbol	Max.	Unit
Forward Voltage at $I_F = 100\text{ mA}$	$V_F$	1.2	V
Reverse Current at $V_R = 80\text{ V}$	$I_R$	0.1	$\mu\text{A}$
Capacitance Between Terminals at $V_R = 0.5\text{ V}$ , $f = 1\text{ MHz}$	$C_T$	3	pF
Reverse Recovery Time at $V_R = 6\text{ V}$ , $I_F = 10\text{ mA}$ , $R_L = 100\text{ }\Omega$	$t_{rr}$	4	ns

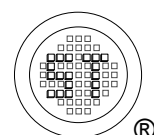

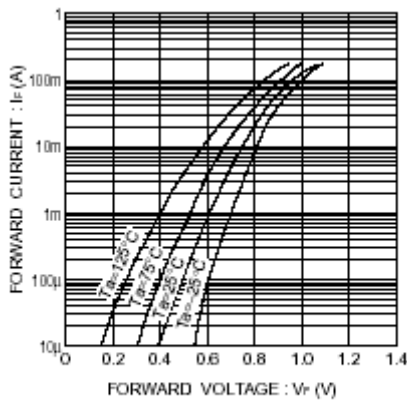

Fig.1 Forward characteristics

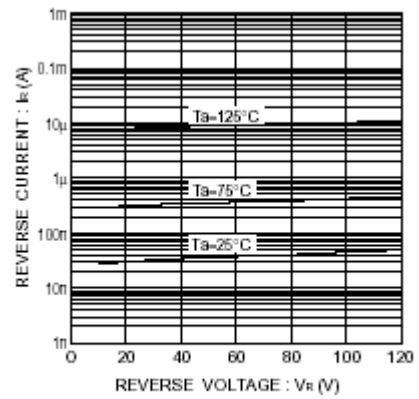

Fig.2 Reverse characteristics

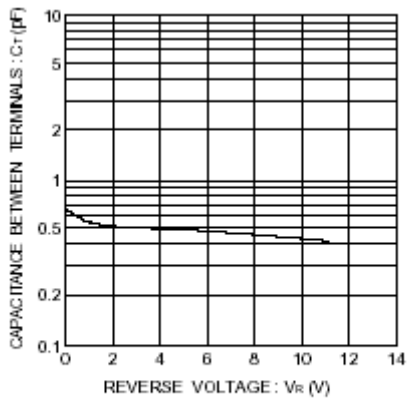

Fig.3 Capacitance between terminals

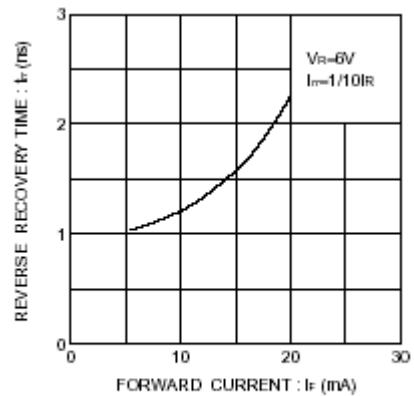

Fig.4 Reverse recovery time characteristics

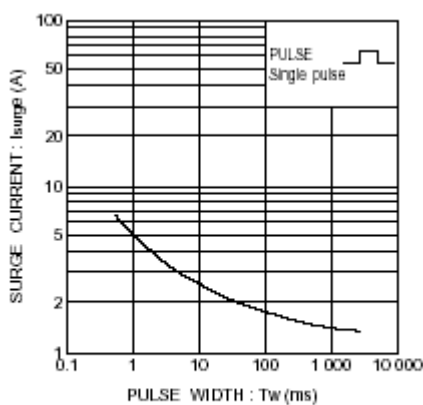

Fig.5 Surge current characteristics

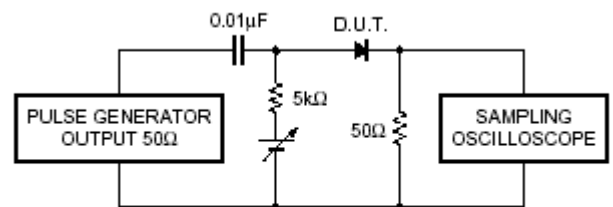
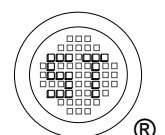

Fig.6 Reverse recovery time ( $t_r$ ) measurement circuit



# 1SS400

## PACKAGE OUTLINE

Plastic surface mounted package; 2 leads

SOD-523

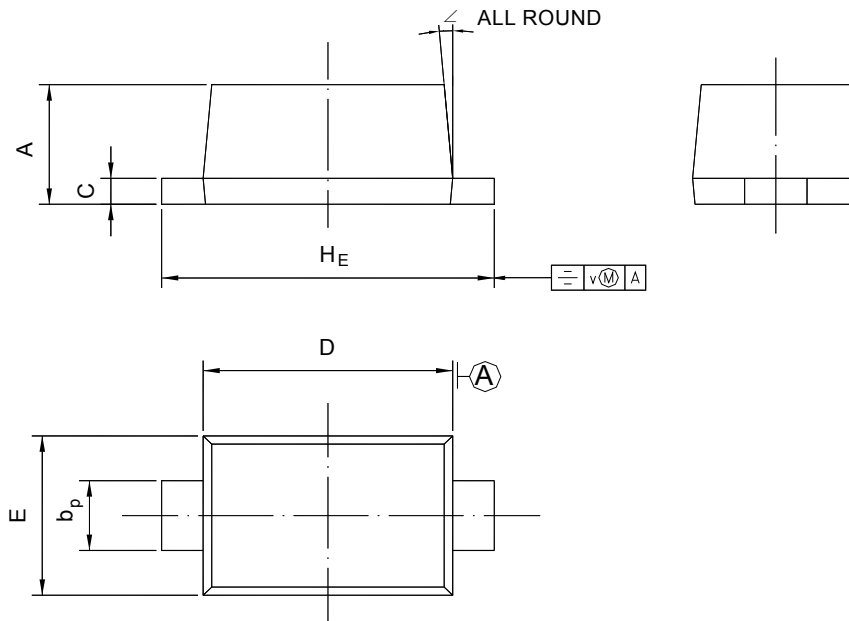

UNIT	A	b <sub>p</sub>	C	D	E	H <sub>E</sub>	V	∠
mm	0.70 0.60	0.4 0.3	0.135 0.100	1.25 1.15	0.85 0.75	1.7 1.5	0.1	5°

