

NCV8720

CMOS Voltage Regulator, Very Low Dropout Bias Rail, 350mA

The NCV8720 is a 350 mA VLDO equipped with NMOS pass transistor and a separate bias supply voltage (V_{BIAS}). The device provides very stable, accurate output voltage with low noise suitable for space constrained, noise sensitive applications. In order to optimize performance for battery operated applications, the NCV8720 features low I_Q consumption. The NCV8720 is offered in WDFN6 2 mm x 2 mm package, wettable flanks option available for Enhanced Optical Inspection.

Features

- Input Voltage Range: 0.8 V to 5.5 V
- Bias Voltage Range: 2.4 V to 5.5 V
- Fixed Output Voltage Device
- Output Voltage Range: 0.8 V to 2.1 V
- $\pm 2\%$ Accuracy over Temperature
- Ultra-Low Dropout: 110 mV typically at 350 mA
- Very Low Bias Input Current of Typ. 80 μ A
- Very Low Bias Input Current in Disable Mode: Typ. 0.5 μ A
- Low Noise, High PSRR
- Built-In Soft-Start with Monotonic V_{OUT} Rise
- Stable with a 2.2 μ F Ceramic Capacitor
- NCV Prefix for Automotive and Other Applications Requiring Unique Site and Control Change Requirements; AEC-Q100 Qualified and PPAP Capable; Device Temperature Grade 1: -40°C to $+125^{\circ}\text{C}$ Ambient Operating Temperature Range
- These are Pb-Free Devices

Typical Applications

- Automotive, Consumer and Industrial Equipment Point of Load Regulation
- Battery-Powered Equipment
- FPGA, DSP and Logic Power Supplies
- Switching Power Supply Post Regulation
- Cameras, DVRs, STB and Camcorders

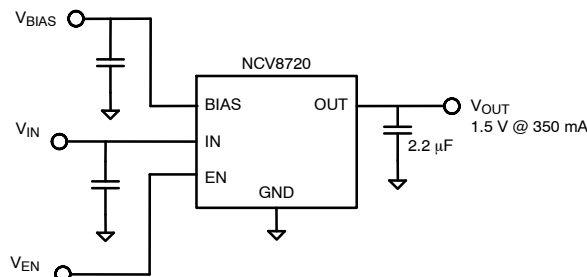

Figure 1. Typical Application Schematics



ON Semiconductor™

www.onsemi.com

MARKING DIAGRAM

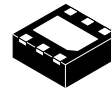

WDFN6
CASE 511BR

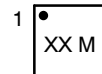

XX = Specific Device Code
M = Date Code

PIN CONNECTIONS

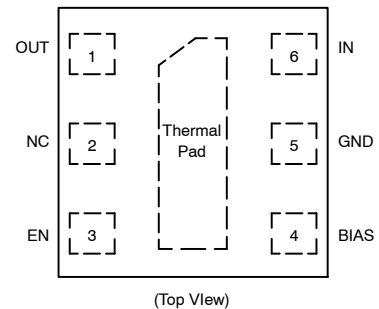

(Top View)

ORDERING INFORMATION

See detailed ordering, marking and shipping information on page 9 of this data sheet.

NCV8720

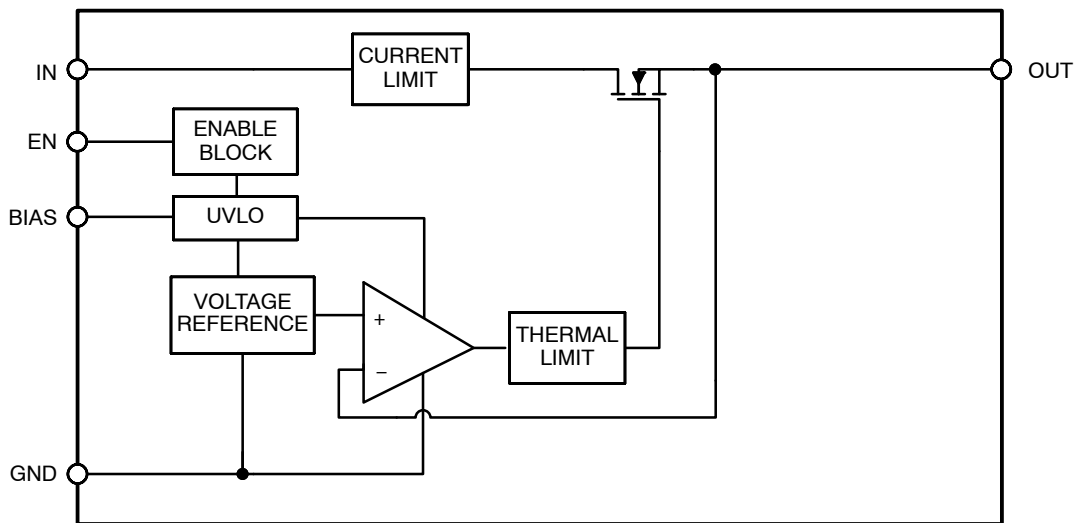

Figure 2. Simplified Schematic Block Diagram

PIN FUNCTION DESCRIPTION

Pin No.	Pin Name	Description
1	OUT	Regulated Output Voltage pin
2	N/C	Not internally connected
3	EN	Enable pin. Driving this pin high enables the regulator. Driving this pin low puts the regulator into shutdown mode.
4	BIAS	Bias voltage supply for internal control circuits. This pin is monitored by internal Under-Voltage Lockout Circuit.
5	GND	Ground pin
6	IN	Input Voltage Supply pin
Pad		Should be soldered to the ground plane for increased thermal performance.

ABSOLUTE MAXIMUM RATINGS

Rating	Symbol	Value	Unit
Input Voltage (Note 1)	V_{IN}	-0.3 to 6	V
Output Voltage	V_{OUT}	-0.3 to $(V_{IN}+0.3) \leq 6$	V
Chip Enable and Bias Input	V_{EN}, V_{BIAS}	-0.3 to 6	V
Output Short Circuit Duration	t_{SC}	unlimited	s
Maximum Junction Temperature	T_J	150	°C
Operating Ambient Temperature Range	T_A	-40 to 125	°C
Storage Temperature	T_{STG}	-55 to 150	°C
ESD Capability, Human Body Model (Note 2)	ESD_{HBM}	2000	V
ESD Capability, Machine Model (Note 2)	ESD_{MM}	200	V

Stresses exceeding those listed in the Maximum Ratings table may damage the device. If any of these limits are exceeded, device functionality should not be assumed, damage may occur and reliability may be affected.

1. Refer to ELECTRICAL CHARACTERISTICS and APPLICATION INFORMATION for Safe Operating Area.
2. This device series incorporates ESD protection (except OUT pin) and is tested by the following methods:
 ESD Human Body Model tested per AEC-Q100-002
 ESD Machine Model tested per AEC-Q100-003
 Latchup Current Maximum Rating ± 100 mA per AEC-Q100-004.

RECOMMENDED OPERATING CONDITIONS

Parameter	Symbol	Min	Max	Unit
Input Voltage	V_{IN}	$(V_{OUT} + V_{DO_IN})$	5.5	V
Bias Voltage	V_{BIAS}	$(V_{OUT} + 1.4) \geq 2.4$	5.5	V
Junction Temperature	T_J	-40	125	°C

Functional operation above the stresses listed in the Recommended Operating Ranges is not implied. Extended exposure to stresses beyond the Recommended Operating Ranges limits may affect device reliability.

THERMAL CHARACTERISTICS

Rating	Symbol	Value	Unit
Thermal Characteristics, WDFN6 2 mm x 2 mm Thermal Resistance, Junction-to-Air (Note 3)	$R_{\theta JA}$	65	°C/W

3. This data was derived by thermal simulations based on the JEDEC JESD51 series standards methodology. Only a single device mounted at the center of a high-K (2s2p) 3in x 3in multilayer board with 1-ounce internal planes and 2-ounce copper on top and bottom. Top copper layer has a dedicated 125 sqmm copper area.

NCV8720

ELECTRICAL CHARACTERISTICS

Over Operating Temperature Range ($T_J = -40^{\circ}\text{C}$ to $+125^{\circ}\text{C}$), $V_{BIAS} = (V_{OUT} + 1.4\text{ V})$ or 2.5 V , whichever is greater; $V_{IN} \geq V_{OUT} + 0.5\text{ V}$, $I_{OUT} = 1\text{ mA}$, $V_{EN} = 1.1\text{ V}$, $C_{OUT} = 2.2\text{ }\mu\text{F}$, unless otherwise noted. Typical values are at $T_J = +25^{\circ}\text{C}$.

Parameter	Test Conditions	Symbol	Min	Typ	Max	Unit	
Operating Input Voltage Range		V_{IN}	$V_{OUT} + V_{DO_IN}$		5.5	V	
Operating Bias Voltage Range		V_{BIAS}	$(V_{OUT} + 1.4) \geq 2.4$		5.5	V	
Output Voltage Range (Note 4)			0.8		2.1	V	
Output Voltage Accuracy	Nominal	$T_J = +25^{\circ}\text{C}$	V_{OUT}		± 0.5	%	
	Over V_{BIAS} , V_{IN} , I_{OUT} , $T_J = -40^{\circ}\text{C}$ to $+125^{\circ}\text{C}$	$V_{OUT} + 1.4\text{ V} \leq V_{BIAS} \leq 5.5\text{ V}$, $V_{OUT} + 0.5\text{ V} \leq V_{IN} \leq 4.5\text{ V}$, $0\text{ mA} \leq I_{OUT} \leq 350\text{ mA}$	V_{OUT}	-2	+2	%	
V_{IN} Line Regulation	$V_{IN} = (V_{OUT} + 0.5\text{ V})$ to 4.5 V , $I_{OUT} = 1\text{ mA}$	$\Delta V_{OUT}/\Delta V_{IN}$		5.0		$\mu\text{V}/\text{V}$	
V_{BIAS} Line Regulation	$V_{BIAS} = (V_{OUT} + 1.4\text{ V})$ or 2.5 V (whichever is greater) to 5.5 V , $I_{OUT} = 1\text{ mA}$	$\Delta V_{OUT}/\Delta V_{BIAS}$		16		$\mu\text{V}/\text{V}$	
Load Regulation	$0\text{ mA} \leq I_{OUT} \leq 350\text{ mA}$ (no load to full load)	$\Delta V_{OUT}/\Delta I_{OUT}$		-1.0		$\mu\text{V}/\text{mA}$	
V_{IN} Dropout Voltage (Note 5)	$V_{IN} = V_{OUT(NOM)} - 0.1\text{ V}$, $(V_{BIAS} - V_{OUT(NOM)}) = 1.4\text{ V}$, $I_{OUT} = 350\text{ mA}$	V_{DO_IN}		110	200	mV	
V_{BIAS} Dropout Voltage (Note 6)	$V_{IN} = V_{OUT(NOM)} + 0.3\text{ V}$, $I_{OUT} = 350\text{ mA}$	V_{DO_BIAS}		1.15	1.4	V	
Output Current Limit	$V_{OUT} = 0.9 \times V_{OUT(NOM)}$	I_{CL}	420	600	1000	mA	
Bias Pin Current	$I_{OUT} = 0\text{ mA}$ to 350 mA	I_{BIAS}		80	110	μA	
Shutdown Current (I_{GND})	$V_{EN} \leq 0.4\text{ V}$, $T_J = -40^{\circ}\text{C}$ to $+85^{\circ}\text{C}$	I_{SHDN}		0.5	2.0	μA	
V_{IN} Power-Supply Rejection Ratio	$V_{IN} - V_{OUT} \geq 0.5\text{ V}$, $I_{OUT} = 350\text{ mA}$	PSRR (V_{IN})	$f = 10\text{ Hz}$		52		dB
			$f = 100\text{ Hz}$		56		
			$f = 1\text{ kHz}$		65		
			$f = 10\text{ kHz}$		46		
			$f = 100\text{ kHz}$		37		
			$f = 1\text{ MHz}$		25		
V_{BIAS} Power-Supply Rejection Ratio	$V_{IN} - V_{OUT} \geq 0.5\text{ V}$, $I_{OUT} = 350\text{ mA}$	PSRR (V_{BIAS})	$f = 10\text{ Hz}$		65		dB
			$f = 100\text{ Hz}$		65		
			$f = 1\text{ kHz}$		70		
			$f = 10\text{ kHz}$		50		
			$f = 100\text{ kHz}$		35		
			$f = 1\text{ MHz}$		24		
Output Noise Voltage	$BW = 10\text{ Hz}$ to 100 kHz	V_N		40		μV_{RMS}	
Inrush Current on V_{IN}		I_{VIN_INRUSH}		$100 + I_{LOAD}$		mA	
Startup Time	$V_{OUT} = 95\% V_{OUT(NOM)}$, $I_{OUT} = 350\text{ mA}$, $C_{OUT} = 2.2\text{ }\mu\text{F}$	t_{STR}		140		μs	
Enable Pin High (enabled)		$V_{EN(HI)}$	1.1			V	
Enable Pin Low (disabled)		$V_{EN(LO)}$	0		0.4	V	
Enable Pin Current	$V_{EN} = 5.5\text{ V}$	I_{EN}		0.3	2.0	μA	
Undervoltage Lock-out	V_{BIAS} rising	UVLO		1.6		V	
Hysteresis	V_{BIAS} falling			0.2		V	
Thermal Shutdown Temperature	Shutdown, temperature increasing	T_{SD}		+160		$^{\circ}\text{C}$	
	Reset, temperature decreasing			+140		$^{\circ}\text{C}$	
Operating Junction Temperature		T_J	-40		+125	$^{\circ}\text{C}$	

Product parametric performance is indicated in the Electrical Characteristics for the listed test conditions, unless otherwise noted. Product performance may not be indicated by the Electrical Characteristics if operated under different conditions.

4. V_{OUT} nominal value is factory programmable.

5. Measured for devices with $V_{OUT(NOM)} \geq 1.2\text{ V}$.

6. $V_{BIAS} - V_{OUT}$ with $V_{OUT} = V_{OUT(NOM)} - 0.1\text{ V}$. Measured for devices with $V_{OUT(NOM)} \geq 1.4\text{ V}$.

NCV8720

APPLICATIONS INFORMATION



Figure 3. Typical Application: Low-Voltage Post-Regulator with ON/OFF functionality

NCV8720

TYPICAL CHARACTERISTICS

$V_{OUT(NOMINAL)} = 1.5\text{ V}$, $V_{BIAS} = (V_{OUT} + 1.4\text{ V})$ or 2.5 V , whichever is greater, $V_{IN} = V_{OUT} + 0.5\text{ V}$, $I_{OUT} = 1\text{ mA}$,
 $V_{EN} = 1.1\text{ V}$, $C_{OUT} = 2.2\text{ }\mu\text{F}$, $T_J = 25^\circ\text{C}$ unless otherwise noted.



Figure 4. V_{IN} Dropout Voltage vs. Output Current



Figure 5. V_{BIAS} Dropout Voltage vs. Temperature

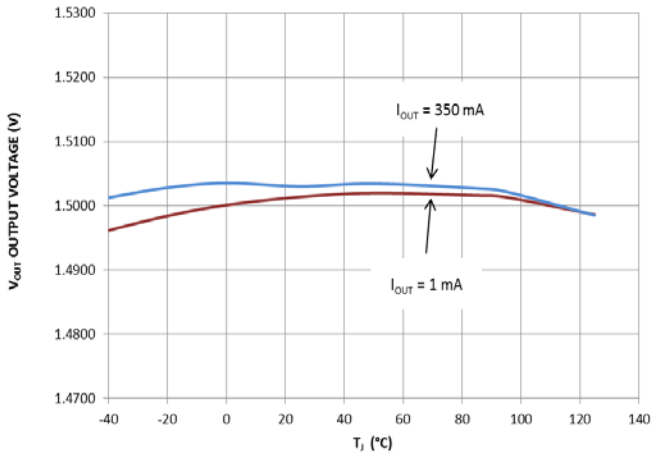

Figure 6. Output Voltage vs. Temperature

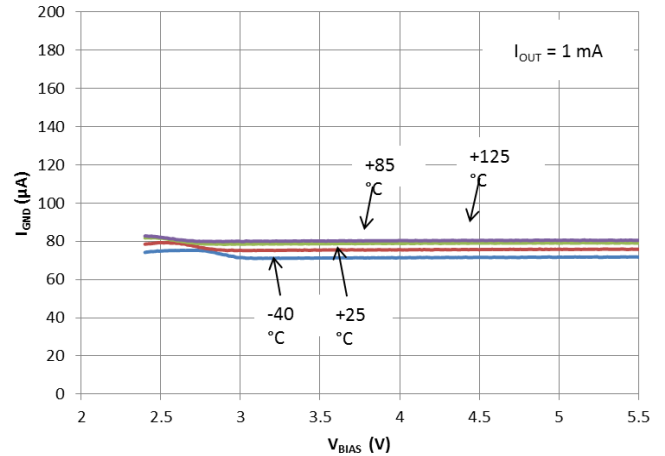

Figure 7. Bias Pin Current vs. V_{BIAS} Input Voltage

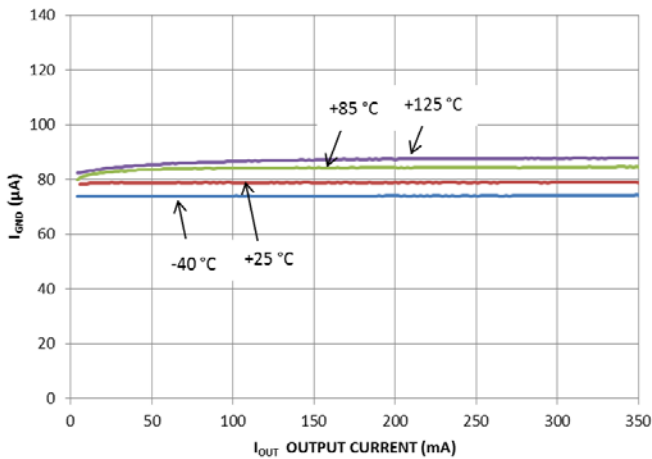

Figure 8. Bias Pin Current vs. Output Current

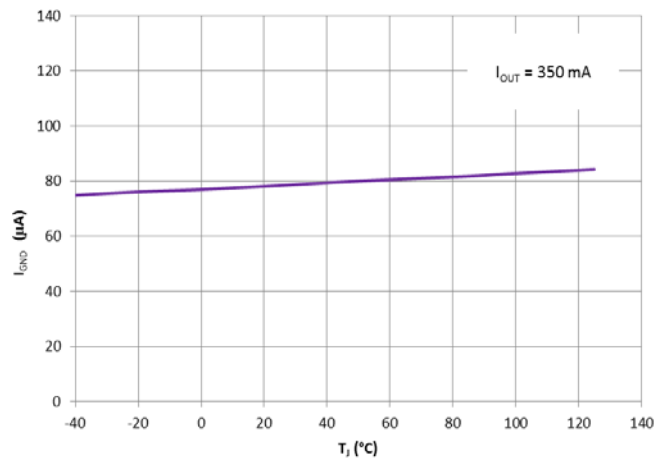

Figure 9. Bias Pin Current vs. Temperature

NCV8720

TYPICAL CHARACTERISTICS

$V_{OUT(NOMINAL)} = 1.5\text{ V}$, $V_{BIAS} = (V_{OUT} + 1.4\text{ V})$ or 2.5 V , whichever is greater, $V_{IN} = V_{OUT} + 0.5\text{ V}$, $I_{OUT} = 1\text{ mA}$,
 $V_{EN} = 1.1\text{ V}$, $C_{OUT} = 2.2\text{ }\mu\text{F}$, $T_J = 25^\circ\text{C}$ unless otherwise noted.



Figure 10. Shutdown Current vs. V_{BIAS} Input Voltage



Figure 11. Current Limit vs. V_{BIAS} Input Voltage



Figure 12. Current Limit vs. V_{IN} Input Voltage



Figure 13. V_{IN} Power Supply Ripple Rejection vs. Frequency



Figure 14. V_{BIAS} Power Supply Ripple Rejection vs. Frequency

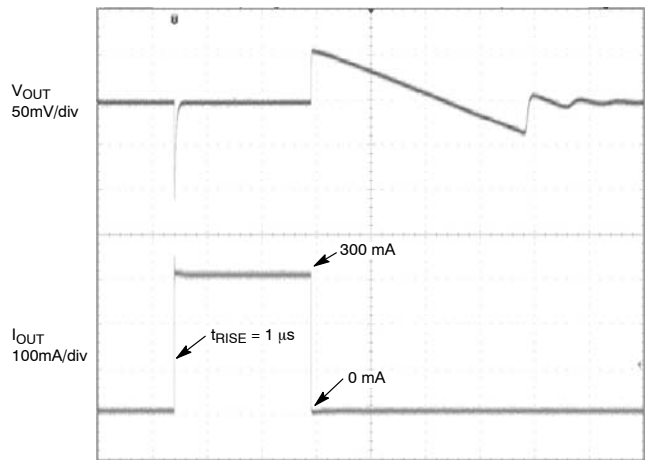

Figure 15. Load Transient Response

APPLICATIONS INFORMATION

The NCV8720 dual-rail very low dropout voltage regulator is using NMOS pass transistor for output voltage regulation from V_{IN} voltage. All the low current internal control circuitry is powered from the V_{BIAS} voltage.

The use of an NMOS pass transistor offers several advantages in applications. Unlike a PMOS topology devices, the output capacitor has reduced impact on loop stability. V_{IN} to V_{OUT} operating voltage difference can be very low compared with standard PMOS regulators in very low V_{IN} applications.

The NCV8720 offers built-in Soft-Start with monotonic V_{OUT} rise. The controlled voltage rising limits the inrush current.

The Enable (EN) input is equipped with internal hysteresis.

NCV8720 is a Fixed Voltage linear regulator.

Dropout Voltage

Because of two power supply inputs V_{IN} and V_{BIAS} and one V_{OUT} regulator output, there are two Dropout voltages specified.

The first, the V_{IN} Dropout voltage is the voltage difference ($V_{IN} - V_{OUT}$) at which the regulator output no longer maintains regulation against further reductions in input voltage. V_{BIAS} is high enough, specific value is published in the Electrical Characteristics table.

The second, V_{BIAS} dropout voltage is the voltage difference ($V_{BIAS} - V_{OUT}$) at which the regulator output no longer maintains regulation against further reductions in V_{BIAS} voltage. V_{IN} is high enough.

Input and Output Capacitors

The device is designed to be stable for ceramic output capacitors with Effective capacitance in the range from 2.2 μ F to 10 μ F. The device is also stable with multiple capacitors in parallel, having the total effective capacitance in the specified range.

In applications where no low input supplies impedance available (PCB inductance in V_{IN} and/or V_{BIAS} inputs as example), the recommended $C_{IN} = 1 \mu$ F and $C_{BIAS} = 0.1 \mu$ F or greater. Ceramic capacitors are recommended. For the best performance all the capacitors should be connected to

the NCV8720 respective pins directly in the device PCB copper layer, not through vias having not negligible impedance.

When using small ceramic capacitor, their capacitance is not constant but varies with applied DC biasing voltage, temperature and tolerance. The effective capacitance can be much lower than their nominal capacitance value, most importantly in negative temperatures and higher LDO output voltages. That is why the recommended Output capacitor capacitance value is specified as Effective value in the specific application conditions.

Enable Operation

The enable pin will turn the regulator on or off. The threshold limits are covered in the electrical characteristics table in this data sheet. If the enable function is not to be used then the pin should be connected to V_{IN} or V_{BIAS} . When enabled, the device consumes roughly 20 μ A from V_{in} supply per 1 V nominal output voltage. That is why using the enable / disable function in power saving applications is recommended.

Current Limitation

The internal Current Limitation circuitry allows the device to supply the full nominal current and surges but protects the device against Current Overload or Short.

Thermal Protection

Internal thermal shutdown (TSD) circuitry is provided to protect the integrated circuit in the event that the maximum junction temperature is exceeded. When TSD activated, the regulator output turns off. When cooling down under the low temperature threshold, device output is activated again. This TSD feature is provided to prevent failures from accidental overheating.

Power Dissipation

The maximum power dissipation supported by the device is dependent upon board design and layout. Mounting pad configuration on the PCB, the board material, and the ambient temperature affect the rate of junction temperature rise for the part. For reliable operation junction temperature should be limited to +125°C.

NCV8720

ORDERING INFORMATION

Device	Nominal Output Voltage	Marking	Package	Shipping [†]
NCV8720BMT090TBG	0.90 V	LU	WDFN6 (Non-Wettable Flank) (Pb-Free)	3000 / Tape & Reel
NCV8720BMT100TBG	1.00 V	LA		
NCV8720BMT105TBG	1.05 V	LC		
NCV8720BMT110TBG	1.10 V	LD		
NCV8720BMT115TBG	1.15 V	LE		
NCV8720BMT120TBG	1.20 V	LF		
NCV8720BMT125TBG	1.25 V	LG		
NCV8720BMT130TBG	1.30 V	LH		
NCV8720BMT135TBG	1.35 V	LJ		
NCV8720BMT140TBG	1.40 V	LK		
NCV8720BMT145TBG	1.45 V	LL		
NCV8720BMT150TBG	1.50 V	LM		
NCV8720BMT160TBG	1.60 V	LN		
NCV8720BMT170TBG	1.70 V	LP		
NCV8720BMT180TBG	1.80 V	LQ		
NCV8720BMTW090TBG	0.90 V	KU	WDFN6 (Wettable Flank) (Pb-Free)	3000 / Tape & Reel
NCV8720BMTW110TBG	1.10 V	KD		
NCV8720BMTW120TBG	1.20 V	KF		
NCV8720BMTW130TBG	1.30 V	KH		
NCV8720BMTW150TBG	1.50 V	KM		
NCV8720BMTW180TBG	1.80 V	KQ		

[†]For information on tape and reel specifications, including part orientation and tape sizes, please refer to our Tape and Reel Packaging Specifications Brochure, BRD8011/D.

To order other package and voltage variants, please contact your ON sales representative

MECHANICAL CASE OUTLINE

PACKAGE DIMENSIONS

ON Semiconductor®



SCALE 4:1

WDFN6 2x2, 0.65P
CASE 511BR
ISSUE B

DATE 19 JAN 2016

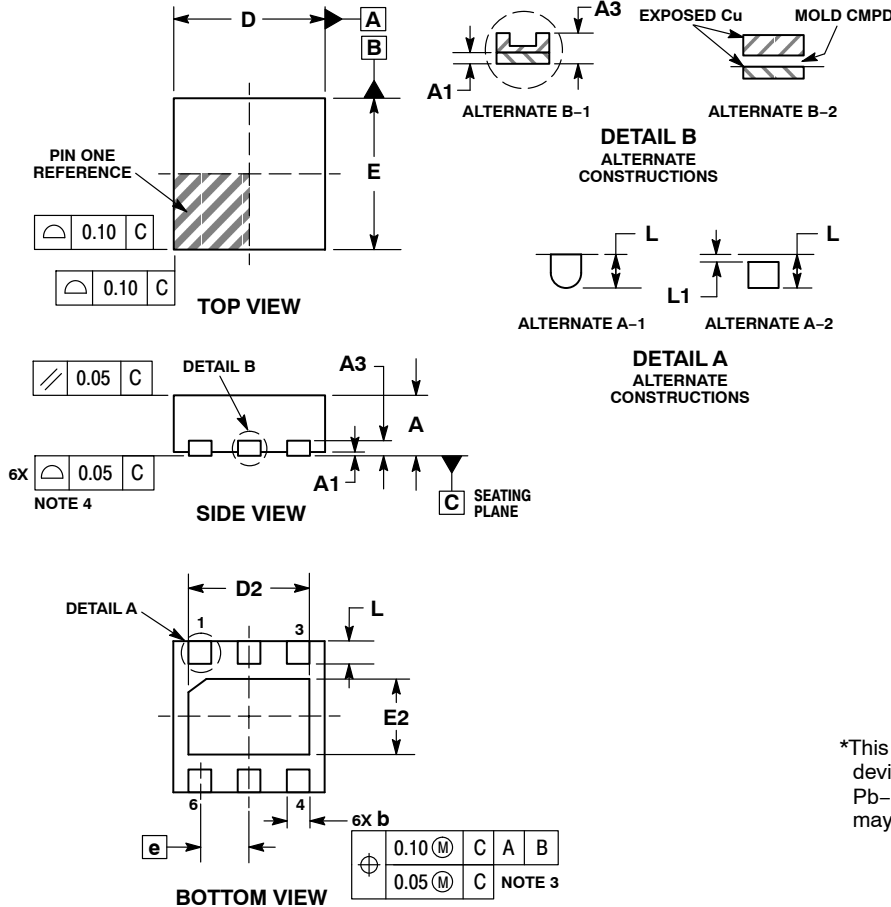

- NOTES:
1. DIMENSIONING AND TOLERANCING PER ASME Y14.5M, 1994.
 2. CONTROLLING DIMENSION: MILLIMETERS.
 3. DIMENSION b APPLIES TO PLATED TERMINAL AND IS MEASURED BETWEEN 0.15 AND 0.25 mm FROM THE TERMINAL TIP.
 4. COPLANARITY APPLIES TO THE EXPOSED PAD AS WELL AS THE TERMINALS.
 5. FOR DEVICES CONTAINING WETTABLE FLANK OPTION, DETAIL A ALTERNATE CONSTRUCTION A-2 AND DETAIL B ALTERNATE CONSTRUCTION B-2 ARE NOT APPLICABLE.

DIM	MILLIMETERS	
	MIN	MAX
A	0.70	0.80
A1	0.00	0.05
A3	0.20	REF
b	0.25	0.35
D	2.00	BSC
D2	1.50	1.70
E	2.00	BSC
E2	0.90	1.10
e	0.65	BSC
L	0.20	0.40
L1	---	0.15

GENERIC MARKING DIAGRAM*

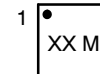

XX = Specific Device Code
M = Date Code

*This information is generic. Please refer to device data sheet for actual part marking. Pb-Free indicator, "G" or microdot "▪", may or may not be present.

RECOMMENDED MOUNTING FOOTPRINT

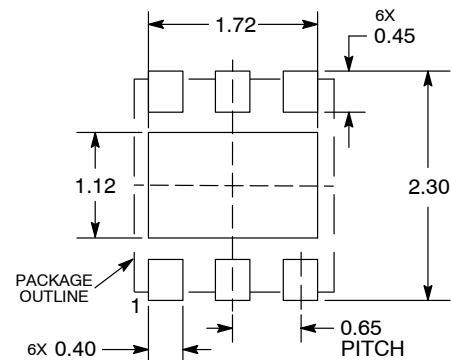

DIMENSIONS: MILLIMETERS

DOCUMENT NUMBER:	98AON55829E	Electronic versions are uncontrolled except when accessed directly from the Document Repository. Printed versions are uncontrolled except when stamped "CONTROLLED COPY" in red.
DESCRIPTION:	WDFN6 2X2, 0.65P	PAGE 1 OF 1

ON Semiconductor and are trademarks of Semiconductor Components Industries, LLC dba ON Semiconductor or its subsidiaries in the United States and/or other countries. ON Semiconductor reserves the right to make changes without further notice to any products herein. ON Semiconductor makes no warranty, representation or guarantee regarding the suitability of its products for any particular purpose, nor does ON Semiconductor assume any liability arising out of the application or use of any product or circuit, and specifically disclaims any and all liability, including without limitation special, consequential or incidental damages. ON Semiconductor does not convey any license under its patent rights nor the rights of others.

ON Semiconductor and  are trademarks of Semiconductor Components Industries, LLC dba ON Semiconductor or its subsidiaries in the United States and/or other countries. ON Semiconductor owns the rights to a number of patents, trademarks, copyrights, trade secrets, and other intellectual property. A listing of ON Semiconductor's product/patent coverage may be accessed at www.onsemi.com/site/pdf/Patent-Marking.pdf. ON Semiconductor reserves the right to make changes without further notice to any products herein. ON Semiconductor makes no warranty, representation or guarantee regarding the suitability of its products for any particular purpose, nor does ON Semiconductor assume any liability arising out of the application or use of any product or circuit, and specifically disclaims any and all liability, including without limitation special, consequential or incidental damages. Buyer is responsible for its products and applications using ON Semiconductor products, including compliance with all laws, regulations and safety requirements or standards, regardless of any support or applications information provided by ON Semiconductor. "Typical" parameters which may be provided in ON Semiconductor data sheets and/or specifications can and do vary in different applications and actual performance may vary over time. All operating parameters, including "Typicals" must be validated for each customer application by customer's technical experts. ON Semiconductor does not convey any license under its patent rights nor the rights of others. ON Semiconductor products are not designed, intended, or authorized for use as a critical component in life support systems or any FDA Class 3 medical devices or medical devices with a same or similar classification in a foreign jurisdiction or any devices intended for implantation in the human body. Should Buyer purchase or use ON Semiconductor products for any such unintended or unauthorized application, Buyer shall indemnify and hold ON Semiconductor and its officers, employees, subsidiaries, affiliates, and distributors harmless against all claims, costs, damages, and expenses, and reasonable attorney fees arising out of, directly or indirectly, any claim of personal injury or death associated with such unintended or unauthorized use, even if such claim alleges that ON Semiconductor was negligent regarding the design or manufacture of the part. ON Semiconductor is an Equal Opportunity/Affirmative Action Employer. This literature is subject to all applicable copyright laws and is not for resale in any manner.

PUBLICATION ORDERING INFORMATION

LITERATURE FULFILLMENT:

Email Requests to: orderlit@onsemi.com

ON Semiconductor Website: www.onsemi.com

TECHNICAL SUPPORT

North American Technical Support:
Voice Mail: 1 800-282-9855 Toll Free USA/Canada
Phone: 011 421 33 790 2910

Europe, Middle East and Africa Technical Support:

Phone: 00421 33 790 2910

For additional information, please contact your local Sales Representative