

Description

The WSD1614DN uses advanced trench technology to provide excellent RDS(ON), low gate charge and operation with gate voltages as low as 1.8V.

This device is suitable for use as a Battery protection or in other Switching application.

Features

High power and current handling capability

Lead free product is acquired

Surface mount package

ESD:1.5KV

Product Summary

BVDSS	RDSON	ID
20V	230mΩ	1.4A

Application

Battery protection

Load switch

DFN1.0X0.6-3L Pin Configuration

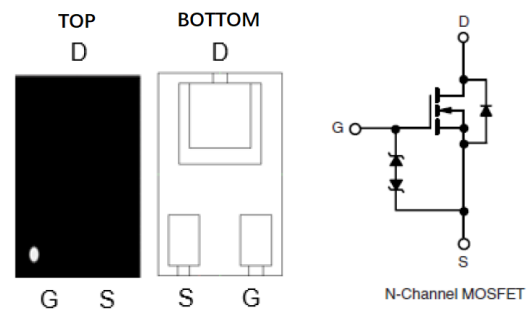

Absolute Maximum Ratings @TA=25°C unless otherwise noted

Symbol	Parameter	Rating	Unit
VDS	Drain-Source Voltage	20	V
VGS	Gate-Source Voltage	±8	V
ID	Drain Current (Continuous) *AC	TA=25°C	1.4
		TA=70°C	1.1
IDM	Drain Current (Pulse) *B	3	A
PD	Power Dissipation	TC=25°C	0.55
TJ/TSTG	Operating Temperature/ Storage Temperature	-55~150	°C

Thermal Resistance Ratings

Symbol	Parameter	Max	Unit
RthJA	Maximum Junction-to-Ambient	Steady-State	180
			°C/W

Electrical Characteristics @TA=25°C unless otherwise noted

Symbol	Parameter	Test Conditions	Min	Typ	Max	Unit
V _{(BR)DSS}	Drain-Source Breakdown Voltage	V _{GS} = 0V, I _D = 250μA	20	--	--	V
I _{DSS}	Zero Gate Voltage Drain Current	V _{DS} = 16V, V _{GS} = 0V	--	--	1	μA
V _{GS(TH)}	Gate Threshold Voltage	V _{GS} = V _{DS} , I _{DS} = 250μA	0.4	--	1	V
I _{GSS}	Gate Leakage Current	V _{GS} = 8V, V _{DS} = 0V	--	--	10	μA
R _{DS(on)}	Drain-Source On-state Resistance	V _{GS} = 4.5V, I _D = 0.55A	--	--	230	mΩ
		V _{GS} = 2.5V, I _D = 0.45A	--	--	305	mΩ
		V _{GS} = 1.8V, I _D = 0.35A	--	--	455	mΩ
V _{SD}	Diode Forward Voltage	I _{SD} = 0.35A, V _{GS} = 0V	--	--	1.2	V
I _S	Diode Forward Current *AC	T _A = 25°C	--	--	0.58	A
Q _g	Total Gate Charge	V _{GS} = 4.5V, V _{DS} = 10V, I _D = 1A	--	2	--	nC
Q _{gs}	Gate-Source Charge		--	0.3	--	nC
Q _{gd}	Gate-Drain Charge		--	0.3	--	nC
t _{d(on)}	Turn-on Delay Time	V _{GS} = 4.5V, V _{DS} = 10V, R _G = 6Ω, I _D = 2A	--	1.2	--	ns
t _r	Turn-on Rise Time		--	25	--	ns
t _{d(off)}	Turn-off Delay Time		--	14	--	ns
t _f	Turn-Off Fall Time		--	15	--	ns
C _{iss}	Input Capacitance	V _{DS} = 10V, V _{GS} = 0V, f = 1.0MHz	--	43	--	pF
C _{oss}	Output Capacitance		--	9	--	pF
C _{rss}	Reverse Transfer Capacitance		--	6	--	pF

Note:

A: The value of R_{θJA} is measured with the device mounted on 1in2 FR-4 board with 2oz. Copper, in a still air environment with TA=25°C. The value in any given application depends on the user's specific board design.

B: Repetitive rating, pulse width limited by junction temperature.

C: The current rating is based on the t_s ≤ 10s junction to ambient thermal resistance rating.

Typical Performance Characteristics ((T_J = 25 °C, unless otherwise noted))

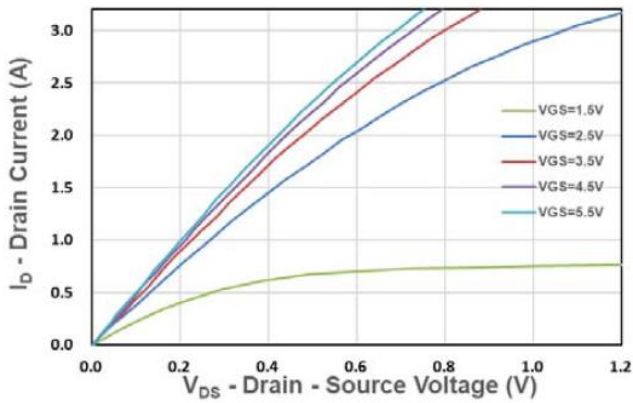

Figure 1. Output Characteristics

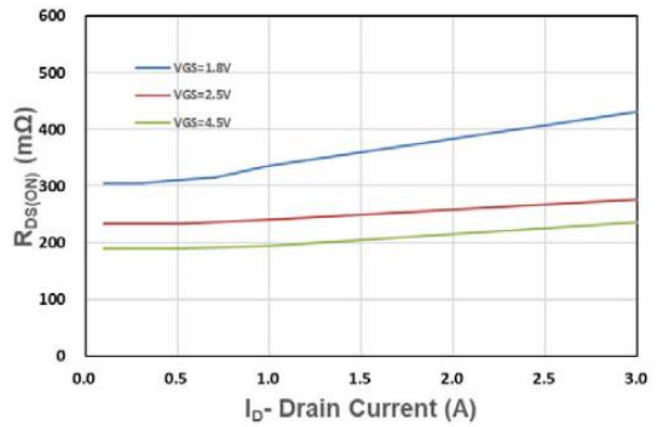

Figure 2. On-Resistance vs. I

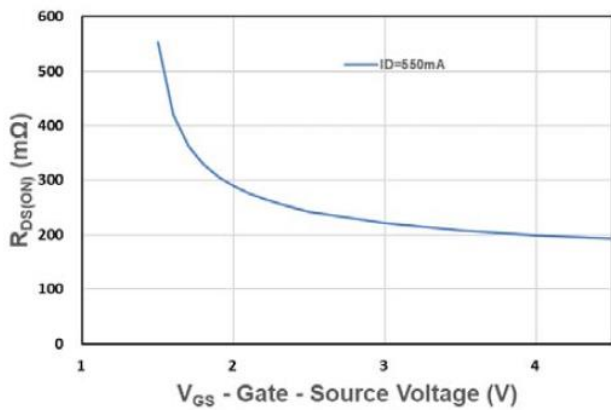

Figure 3. On-Resistance vs. V_{GS}

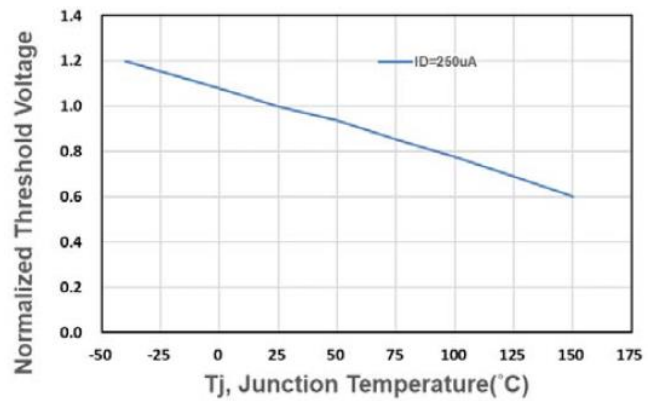

Figure 4. Gate Threshold Voltage

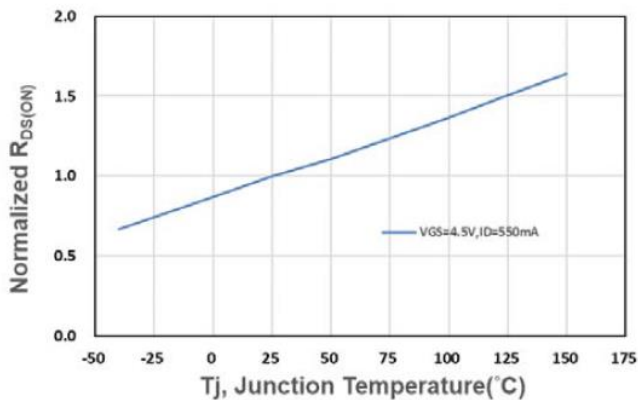

Figure 5. Drain-Source On Resistance

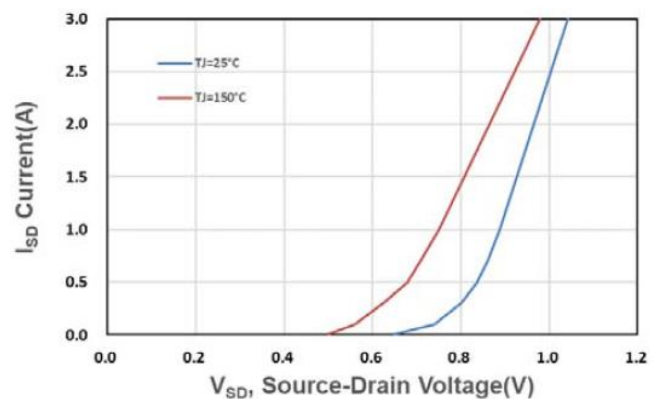

Figure 6. Source-Drain Diode Forward

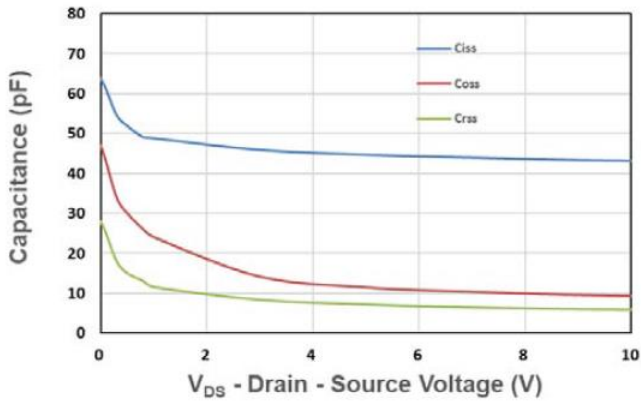

Figure 7. Capacitance

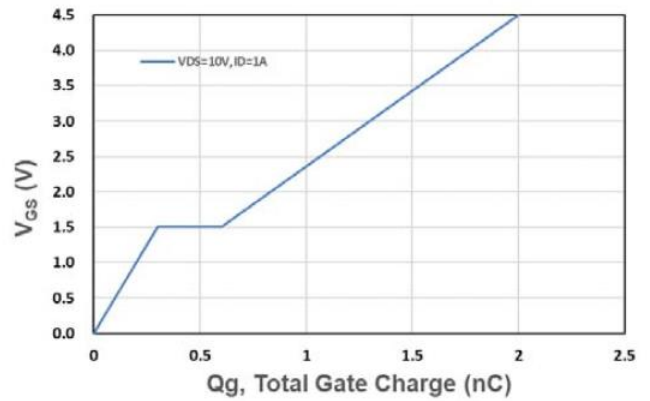

Figure 8. Gate Charge Characteristics

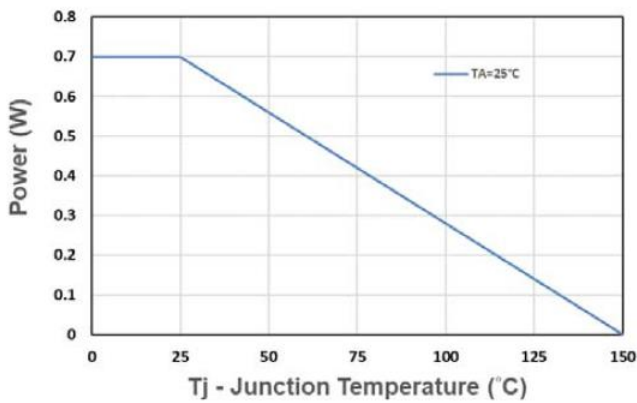

Figure 9. Power Dissipation

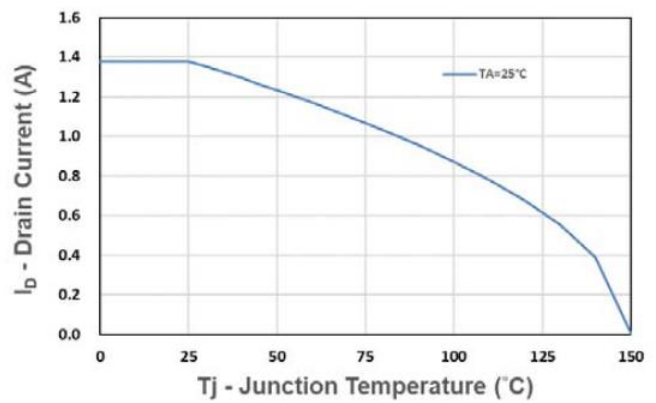

Figure 10. Drain Current

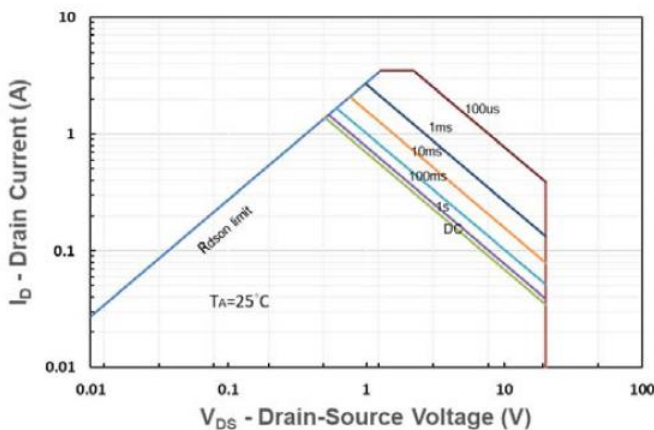

Figure 11. Safe Operating Area

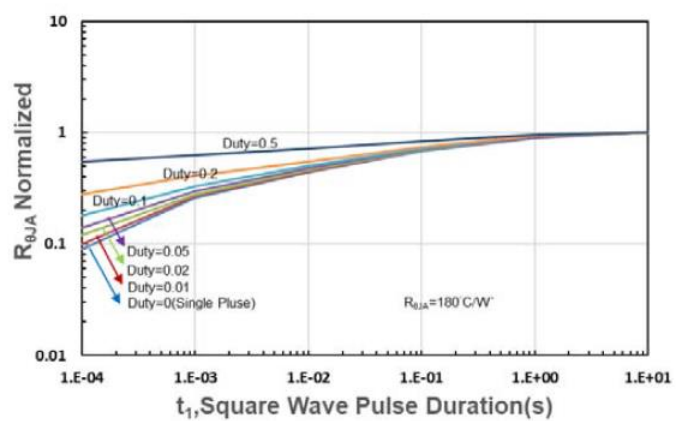
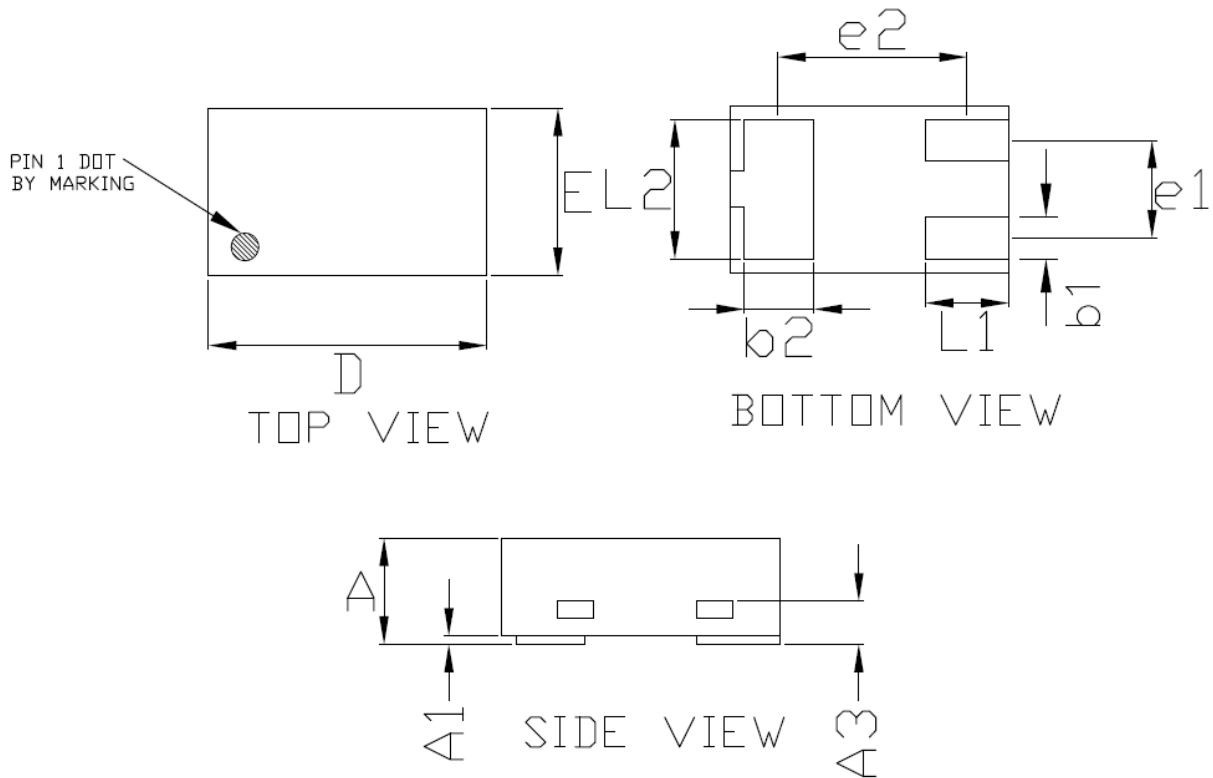

Figure 12. $R_{\theta JA}$ Transient Thermal Impedance

DFN1.0*0.6-3L



COMMON DIMENSIONS(MM)			
PKG.	X1:EXTREME THIN		
REF.	MIN.	NOM.	MAX
A	>0.40	-	0.50
A1	0.00	-	0.05
A3	0.125 REF.		
D	0.95	1.00	1.05
E	0.55	0.60	0.65
b1	0.10	0.15	0.20
b2	0.20	0.25	0.30
L1	0.20	0.30	0.40
L2	0.40	0.50	0.60
e1	0.35 BSC		
e2	0.675 BSC		



Attention

- 1, Any and all Winsok power products described or contained herein do not have specifications that can handle applications that require extremely high levels of reliability, such as life-support systems, aircraft's control systems, or other applications whose failure can be reasonably expected to result in serious physical and/or material damage. Consult with your Winsok power representative nearest you before using any Winsok power products described or contained herein in such applications.
- 2, Winsok power assumes no responsibility for equipment failures that result from using products at values that exceed, even momentarily, rated values (such as maximum ratings, operating condition ranges, or other parameters) listed in products specifications of any and all Winsok power products described or contained herein.
- 3, Specifications of any and all Winsok power products described or contained herein stipulate the performance, characteristics, and functions of the described products in the independent state, and are not guarantees of the performance, characteristics, and functions of the described products as mounted in the customer's products or equipment. To verify symptoms and states that cannot be evaluated in an independent device, the customer should always evaluate and test devices mounted in the customer's products or equipment.
- 4, Winsok power Semiconductor CO., LTD. strives to supply high-quality high-reliability products. However, any and all semiconductor products fail with some probability. It is possible that these probabilistic failures could give rise to accidents or events that could endanger human lives that could give rise to smoke or fire, or that could cause damage to other property. When designing equipment, adopt safety measures so that these kinds of accidents or events cannot occur. Such measures include but are not limited to protective circuits and error prevention circuits for safe design, redundant design, and structural design.
- 5, In the event that any or all Winsok power products (including technical data, services) described or contained herein are controlled under any of applicable local export control laws and regulations, such products must not be exported without obtaining the export license from the authorities concerned in accordance with the above law.
- 6, No part of this publication may be reproduced or transmitted in any form or by any means, electronic or mechanical, including photocopying and recording, or any information storage or retrieval system, or otherwise, without the prior written permission of Winsok power Semiconductor CO., LTD.
- 7, Information (including circuit diagrams and circuit parameters) herein is for example only; it is not guaranteed for volume production. Winsok power believes information herein is accurate and reliable, but no guarantees are made or implied regarding its use or any infringements of intellectual property rights or other rights of third parties.
- 8, Any and all information described or contained herein are subject to change without notice due to product/technology improvement, etc. When designing equipment, refer to the "Delivery Specification" for the Winsok power product that you intend to use.
- 9, this catalog provides information as of Sep. 2014. Specifications and information herein are subject to change without notice.