



深圳市首韩科技有限公司

SHENZHEN SHOUHAN TECHNOLOGY CO., LTD

Tel: 0755-27597601 Fax: 0755-27597491

承认书  
SPECIFICATION FOR APPROVAL

客户 Customer:

\_\_\_\_\_

产品名称 Project:

轻触开关

\_\_\_\_\_

规格型号 Part No:

TS6625A4P-XT 160gf 072

\_\_\_\_\_

贵公司承认印 Approval signatures

料号/Part No.	签章/Signatures

日期 Date:

拟制/Drawn	李春风	
审核/Check	钟华华	
批准/Approved	罗孝金	



### SPECIFICATION

1、概述

GENERAL

1.1 适用范围

APPLICATION

此规格书适用于机械式轻触开关的相关要求

This specification is applied to the requirements for TACTILE SWITCH (MECHANICAL CONTACT)

1.2 工作温度范围

Operating Temperature Range

-20°C~80°C (在标准大气压、标准湿度条件下)

-20°C~80°C (Normal humidity, normal air pressure)

1.3 贮藏温度范围

Storage Temperature Range

-20°C~80°C (在标准大气压、标准湿度条件下)

-20°C~80°C (Normal humidity, normal air pressure)

1.4 测试条件

Test Conditions

在没有其它特定的条件下，应该在以下的条件下进行测试和测量：

Unless otherwise specified, tests and measurement shall be made in the following standard conditions:

常温.....5°C~35°C

Normal temperature.....5°C~35°C

标准湿度.....相对湿度25%~85%

Normal humidity.....relative humidity 25%~85%

标准大气压.....86KPa~106Kpa

Normal air pressure.....86Kpa~106Kpa

在制造过程中，测试和测量应该在以下的条件下进行：

If any doubt arise from the judgment, tests shall be conducted at the following conditions:

温度.....20°C±2°C

Temperature.....20°C±2°C

相对湿度.....65%±5%

Relative humidity.....65%±5%

环境气压.....86KPa~106Kpa

Air pressure.....86KPa~106Kpa

## SPECIFICATION

## 2、 详细说明

Detailed specification

## 2.1 外观：应无影响、降低产品性能的缺陷；

Appearance: There should be no defects that affect the serviceability of product.

## 2.2 结构尺寸和安装尺寸：应符合装配图要求

Style and dimension: shall conform to the assemble drawings.

## 2.3 操作形式：有触觉反应的操作

Type of actuating: Tactile feedback.

## 2.4 开关结构：单回路单输出(具体的触点结构在装配图中已绘出)；

Contact arrangement: 1 pole, 1 throw

(Details of contact arrangement are given in the assembly drawings.)

## 2.5 开关工作额定值：DC 12V, 50mA (有效值)    DC 12V, 50mA (最大额定值)    DC 1V, 10 μ A (最小额定值)

Ratings: 12V DC, 50mA (effective value)    12V DC, 50mA (maximum)    1V DC, 10 μ A (minimum)

## 3、 电气性能：

## ELECTRICAL SPECIFICATION

NO.	项目 ITEM	试验条件 TEST CONDITIONS	要求 REQUIREMENTS
3.1	接触电阻 Contact Resistance	在以 5V 10mA的直流电源或不低于1KHz的交流电源的电路中，以一个等于2倍按力的静负荷施加于手柄中心 Applying a static load of 2 times operating force to the center of the stem, measurements shall be made by 5V DC 10mA or more than 1KHZ AC small-current contact resistance meter.	$\leq 50\text{m}\Omega$
3.2	绝缘电阻 Insulation Resistance	在端子之间施加DC 100V /1min的条件下，测量端子之间底座、盖板的电阻值 Measurement shall be made following application of 100V DC potential, across terminals, and across terminals and cover, for one minute.	$\geq 100\text{M}\Omega$



SPECIFICATION

3.3	<p>介质耐压 Dielectric voltage proof</p>	<p>在端子之间施加250V AC (50HZ或60HZ)/1min 250V AC (50HZ or 60HZ) shall be applied across terminals, for one minute.</p>	<p>无击穿、无飞弧 There should be no breakdown and flashover</p>
-----	--	--	---

4、 机械性能:

MECHANICAL SPECIFICATION

NO.	项目 ITEM	试验条件 TEST CONDITIONS	要求 REQUIREMENTS
4.1	<p>按力 Operating Force</p>	<p>开关的动作方向为垂直放置开关向推柄中心逐渐地增加负荷直到推柄停止时所测量的最大负荷。 Placing the switch such that the direction of switch operation is vertical and then gradually increasing the load applied to the center of the stem, the maximum load required for the switch to come to a stop shall be measured.</p>	<p>按力: 160±40gf Operating Force: 160±40gf</p>
4.2	<p>最大行程 Full Travel</p>	<p>开关垂直于操作方向放置, 以一个等于2倍按力的静负荷施加在开关驱动件顶端中心, 测量顶端移动的距离。 Placing the switch such that the direction of switch operation is vertical and then applying static load of 2times operating force to the center of the stem; the travel distance for the switch to come to a stop shall be measured.</p>	<p>0.25±0.1mm</p>
4.3	<p>回弹力 Return Force</p>	<p>开关垂直于操作方向放置, 在开关驱动件顶端中心下降至全行程后, 测量顶端向自由位置转换的力度。 The sample switch is installed such that the direction of switch operation is vertical and upon depressing the stem in its center to the whole travel distance, the force of the stem to return to its free position shall be measured.</p>	<p>回弹力 Return Force: 50 gf min</p>

SPECIFICATION

4.4	停止强度 Stop Strength	<p>开关垂直于操作方向放置，从操作方向向驱动件施加10N的静负荷持续1min。 Placing the switch such that the direction of switch operation is vertical, and then a static load of 10N shall be applied in the direction of stem operation for a period of 1 min.</p>	<p>无机械和电气损坏 There shall be no sign of damage mechanically and electrically.</p>
4.5	可焊性 Solderability	<p>在以下设定条件下进行测量： Measurements shall be made following the test set forth below: (1) 焊接温度: <math>245 \pm 5^{\circ}\text{C}</math> Solder temperature : <math>245 \pm 5^{\circ}\text{C}</math> (2) 浸入时间: <math>2\text{s} \pm 0.5\text{s}</math> Immersion time: <math>2\text{s} \pm 0.5\text{s}</math> 对于其它步骤参考《GB 5095.6—86》试验12a The other steps please refer to 《GB 5095.6-86》TEST 12a</p>	<p>除边缘外涂层应均匀覆盖90%以上 Except for the edge, the coating should cover a minimum 90%</p>

5、 极限电气性能:

ENVIRONMENTAL SPECIFICATION

NO.	项目 ITEM	试验条件 TEST CONDITIONS	要求 REQUIREMENTS
5.1	低温测试 Resistance to low temperature	<p>样品应按照以下实验条件进行测试，实验后样品应放在常温及标准湿度的环境中1小时后做性能测试： Following the test set forth below the sample shall be left in normal temperature and humidity conditions for 1 h before measurements are made: (1) 温度: <math>-30 \pm 2^{\circ}\text{C}</math> Temperature : <math>-30 \pm 2^{\circ}\text{C}</math> (2) 时间: 96h Time: 96h</p>	<p>接触电阻: <math>\leq 500\text{m}\Omega</math> Contact resistance: <math>\leq 500\text{m}\Omega</math> 项目3, 4 Item 3, 4</p>
5.2	高温测试 Heat resistance	<p>样品应按照以下实验条件进行测试，实验后样品应放在常温及标准湿度的环境中1小时后做性能测试： Following the test set forth below the sample shall be left in normal temperature and humidity conditions for 1 h before measurements are made: (1) 温度: <math>80 \pm 2^{\circ}\text{C}</math> temperature: <math>80 \pm 2^{\circ}\text{C}</math> (2) 时间: 96h time: 96h</p>	

SPECIFICATION

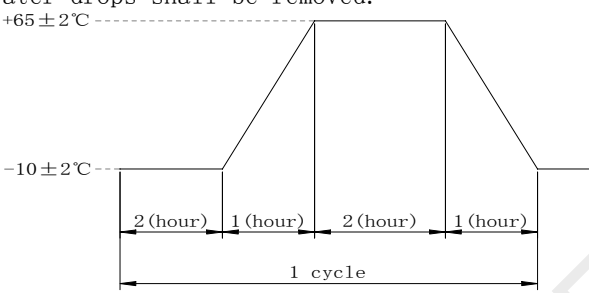
<p>5.3</p>	<p>温度周期性测试 Change of temperature</p>	<p>根据下面的测试要求进行5次循环的温度周期性测试，实验后样品应放在常温及标准湿度的环境中1小时后做性能测试。测试期间样品应保持干燥。 After 5 cycles of following conditions, the sample shall be allowed to stand under normal temperature and humidity conditions for 1 h. and measurements shall be made. During the test water drops shall be removed.</p> 	<p>接触电阻: <math>\leq 500m\Omega</math> Contact resistance: <math>\leq 500m\Omega</math> 项目3, 4 Item 3, 4</p>
<p>5.4</p>	<p>湿温测试 Moisture resistance</p>	<p>样品应按照以下实验条件进行测试，实验后样品应放在常温及标准湿度的环境中1小时后做性能测试： Following the test set forth below the sample shall be left in normal temperature and humidity conditions for 1 h before measurements are made: (1) 温度: <math>60\pm 2^{\circ}C</math> temperature: <math>60\pm 2^{\circ}C</math> (2) 相对湿度: 90%~95% relative humidity: 90% to 95% (3) 时间: 96h time: 96h</p>	
<p>5.5</p>	<p>盐雾试验 Salt Mist (铁材质不做盐雾要求)</p>	<p>在以下设定条件下进行测量： The switch shall be checked after following test: (1) 温度: <math>35^{\circ}C\pm 2^{\circ}C</math> temperature: <math>35^{\circ}C\pm 2^{\circ}C</math> (2) 盐溶液浓度: <math>5\pm 1\%</math> (质量百分比) salt solution : <math>5\pm 1\%</math>(solids by mass) (3) 时间: 24h Time: 24h 实验后的盐沉积物后水冲掉 After test, salt deposit shall be removed by running water.</p>	<p>金属件上没有腐蚀斑点 No remarkable corrosion shall be recognized in metal part.</p>

SPECIFICATION

6、 极限机械性能:

ENDURANCE SPECIFICATION

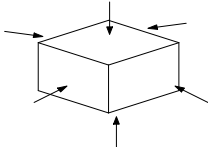
NO.	项目 ITEM	试验条件 TEST CONDITIONS	要求 REQUIREMENTS
6.1	工作寿命 Operation life	根据下面的测试要求进行测试: Measurement shall be made following the test set forth below: (1) DC 5V, 5mA带负载 DC 5V, 5 mA resistive load (2) 按动速率: 2次/秒 Rate of operation: 2 times/s (3) 按力: 按力+50g Operating Force: 按力+50g (4) 平均无故障寿命/Average fault-free life:500000次	接触电阻 $\leq 500m\Omega$ Contact resistance $\leq 500m\Omega$ 按力: 初值的 $\pm 30\%$ Operating Force: initial value $\pm 30\%$
6.2	抗冲击 Impact Shock Resistance	Measurements shall be made following the test set forth below: 按下列条件进行冲击试验 (1) Acceleration:80g 加速度 (2) Cycles of test :3 cycles each in 6directions, for a total of 18cycles 试验次数: 每个方向3次, 6个方向共18次 	项目 3 项目 4.1、4.2 Item 3 Item4.1、4.2

7、 焊接条件:

SOLDERING CONDITIONS:

NO.	项目 ITEM	试验条件 TEST CONDITIONS	要求 REQUIREMENTS
7.1	手工焊接 Hand soldering	请按以下条件进行焊接: (1) 焊锡温度: $\leq 350^{\circ}C$ (2) 连续焊接时间: $\leq 3$ s (3) 电烙铁的功率: $\leq 20W$ Please practice according to below conditions: (1) Soldering temperature: $350^{\circ}C$ Max. (2) Continuous soldering time: 3 s Max. (3) Capacity of soldering iron: $\leq 20$ W	

SPECIFICATION

7.2

自动焊接  
Automatic soldering

对于SMT产品，请按以下条件进行焊接  
For the product of SMT , type solder according to the following conditions

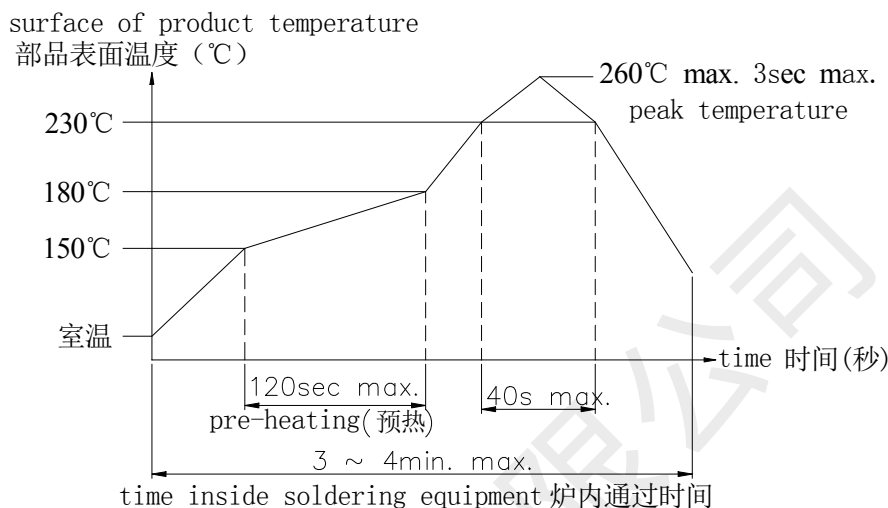

注意：以上提及的条件是零部件上PWB表面的温度，由于PWB的材料、尺寸、厚度等不同，PWB从开关表面获得的温度也会有很大不同，因此，千万小心不要让开关表面温度超过260°C

Caution: the condition mentioned above is a temperature on the PWB surface on which parts are mounted. There are cases where PWB temperature greatly differs from switch's surface temperature depending on PWB material, size, thickness, etc. The switch's surface temperature shall not allowed to exceed 260°C

8、其他注意事项

- 1、考虑清洗轻触式开关时，请与我们联系。
- 2、请不要从轻触式开关上面浸入助焊剂。
- 3、给端子进行焊接时，如果在端子上施加负荷，因条件不同会有松动，变形及电特性劣化的可能，请在使用时注意。
- 4、使用通孔印刷电路板及推荐以外的电路板时，由于热应力的影响会发生变化，所以请事先就焊接条件进行充分的确认。
- 5、进行两次焊接时，请在第一次焊接部分回复到常温之后再行进行。连续加热可能使外围部变形，端子的松动，脱落及电特性降低。
- 6、关于焊接的条件设定，需要确认实际批量生产条件。
- 7、本产品以直流的电阻负荷为前提设计制造的。作为其他的负荷【感性负荷（L），电容性负荷（C）】使用时，请另行联系。
- 8、此开关请用于直接由人操作按开关的结构。请不要用于机械性的检测功能。
- 9、开关操作时，如果实施规定以上的负荷，开关将有被损坏的可能。请注意不要在开关上施加规定以上的力。
- 10、请避免从横侧按操作部的用法。
- 11、如果使用开关的整机的周围材料产生腐蚀性气体，将有可能造成接触不良等现象，所以请事先进行充分的确认。
- 12、关于密闭型以外的型号，对异物的侵入，请充分注意。
- 13、保管方法
  - ① 产品以交货时的状态在常温，常湿，不受直射阳光照射，不产生腐蚀性气体的地方保管，自交货起3个月以内为限度，请尽可能早点使用。
  - ② 开封后为了用聚乙烯袋与外气隔断，请在与上述同样的环境中进行保管，并尽快使用。
  - ③ 请不要过分的堆积。
  - ④ 请不要在按断了开关操作部的状态下进行保存。
- 14、进行焊接过程中，不可以用溶剂或类似品清洗开关。
- 15、防止助焊剂从开关的外部渗入。



TH-E004-3

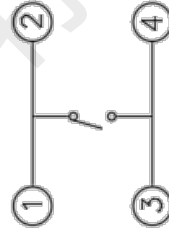
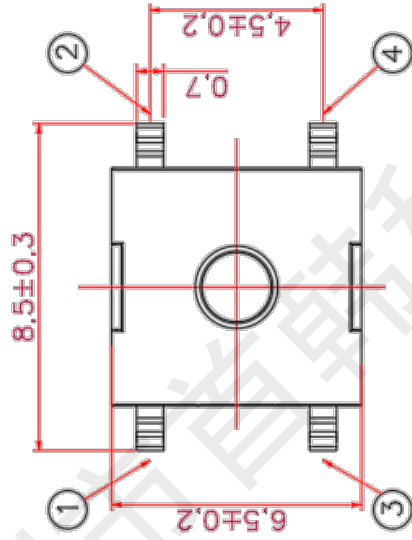
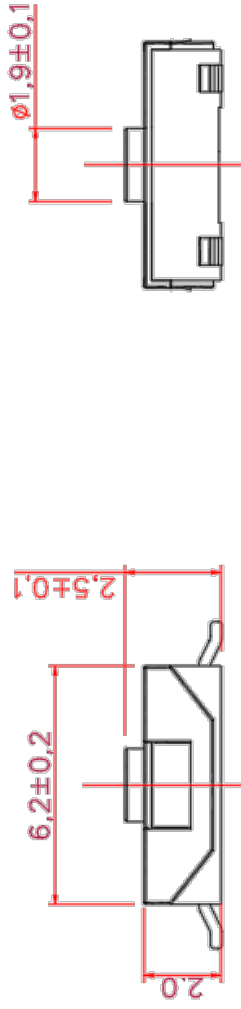
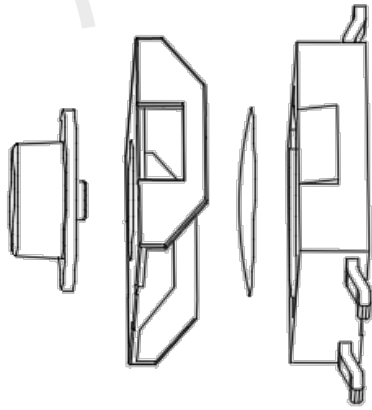

电路图

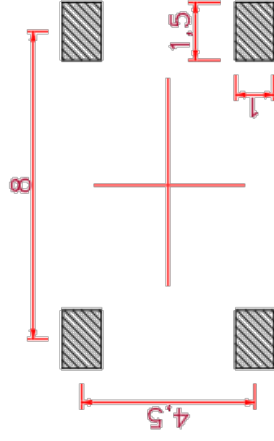
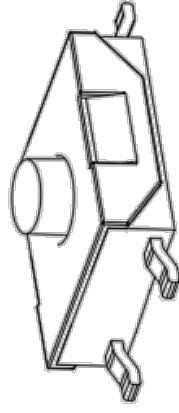

PCB. 焊接图

主要技术规格:

1. 额定值: 50mA DC12V
2. 接触电阻:  $\leq 100m\Omega$
3. 操作力: 160±40gf
4. 行程: 0.25±0.1mm
5. 绝缘电阻:  $\geq 100M\Omega$
6. 抗电强度: 250V 50HZ 1Min.
7. 寿命: 500,000 Cycles

第一视角



名称:

轻触开关

型号:

TS6625A4P-XT 160gf 072



深圳市首韩科技有限公司

5	引脚、触点	黄铜	1	镀银																
4	底座	PPA	1	耐温280℃																
3	簧片	不锈钢	1	覆银																
2	盖板	不锈钢	1	/																
1	按钮	硅胶	1	耐温280℃																
序号	零件名称	材料规格	数量	备注	设计	审核	批准	标记	处数	更改文件号	签名	日期	比例	单位	重量	一般公差	角度			
					李春风	钟华华	罗孝金					2021.5.13	2021.5.13	2021.5.13						