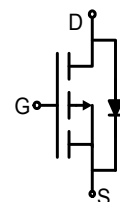
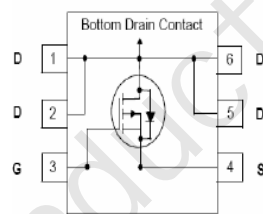
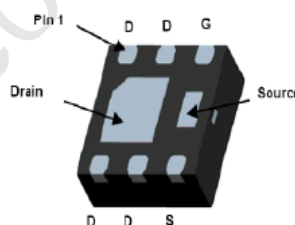

<p>Description</p> <p>The FDMA905P uses advanced trench technology to provide excellent $R_{DS(ON)}$, low gate charge and operation with gate voltages. This device is suitable for use as a load switching application and a wide variety of other applications.</p> <p>General Features</p> <ul style="list-style-type: none"> ● $V_{DS} = -12V, I_D = -16A$ ● $R_{DS(ON)} < 22m\Omega @ V_{GS} = -2.5V$ ● $R_{DS(ON)} < 18m\Omega @ V_{GS} = -4.5V$ ● Advanced trench MOSFET process technology ● Ultra low on-resistance with low gate charge <p>Application</p> <ul style="list-style-type: none"> ● PWM applications ● Load switch ● Battery charge in cellular handset 	<div style="text-align: center;">  <p>Schematic diagram</p>  <p>Pin assignment</p>  <p>DFN2X2-6L bottom view</p> </div>
--	--

Package marking and ordering information

Device Marking	Device	Device Package	Reel Size	Tape Width	Quantity
905T	FDMA905P	DFN2X2-6L	-	-	-

Absolute maximum ratings (TA=25°C unless otherwise noted)

Parameter	Symbol	Limit	Unit
Drain-Source Voltage	V_{DS}	-12	V
Gate-Source Voltage	V_{GS}	±8	V
Drain Current-Continuous	I_D	-16	A
Drain Current -Pulsed (Note 1)	I_{DM}	-65	A
Maximum Power Dissipation	P_D	2.5	W
Operating Junction and Storage Temperature Range	T_J, T_{STG}	-55 To 150	°C

Thermal Characteristic

Thermal Resistance, Junction-to-Ambient (Note 2)	$R_{\theta JA}$	50	°C/W
Thermal Resistance, Junction-to-Case (Note 2)	$R_{\theta JC}$	6.9	°C/W

Electrical characteristics (TA=25°C unless otherwise noted)

Parameter	Symbol	Condition	Min	Typ	Max	Unit
Off Characteristics						
Drain-Source Breakdown Voltage	$V_{(BR)DSS}$	$V_{GS}=0V, I_D=-250\mu A$	-12	-	-	V
Zero Gate Voltage Drain Current	I_{DSS}	$V_{DS}=-12V, V_{GS}=0V$	-	-	-1	μA
Gate-Body Leakage Current	I_{GSS}	$V_{GS}=\pm 8V, V_{DS}=0V$	-	-	± 100	nA
On Characteristics (Note 3)						
Gate Threshold Voltage	$V_{GS(th)}$	$V_{DS}=V_{GS}, I_D=-250\mu A$	-0.4	-0.7	-1	V
Drain-Source On-State Resistance	$R_{DS(on)}$	$V_{GS}=-4.5V, I_D=-6.7A$	-	12	18	m Ω
		$V_{GS}=-2.5V, I_D=-6.2A$	-	14	22	m Ω
Forward Transconductance	g_{FS}	$V_{DS}=-10V, I_D=-6.7A$	-	40	-	S
Dynamic Characteristics (Note4)						
Input Capacitance	C_{iss}	$V_{DS}=-10V, V_{GS}=0V,$ $F=1.0MHz$	-	2700	-	PF
Output Capacitance	C_{oss}		-	680	-	PF
Reverse Transfer Capacitance	C_{rss}		-	590	-	PF
Switching Characteristics (Note 4)						
Turn-on Delay Time	$t_{d(on)}$	$V_{DD}=-10V, I_D=-1A$ $V_{GS}=-4.5V, R_{GEN}=10\Omega$	-	11	-	nS
Turn-on Rise Time	t_r		-	35	-	nS
Turn-Off Delay Time	$t_{d(off)}$		-	30	-	nS
Turn-Off Fall Time	t_f		-	10	-	nS
Total Gate Charge	Q_g	$V_{DS}=-6V, I_D=-10A,$ $V_{GS}=-4.5V$	-	35	48	nC
Gate-Source Charge	Q_{gs}		-	5	-	nC
Gate-Drain Charge	Q_{gd}		-	10	-	nC
Drain-Source Diode Characteristics						
Diode Forward Voltage (Note 3)	V_{SD}	$V_{GS}=0V, I_S=-8A$	-	-	-1.2	V
Diode Forward Current (Note 2)	I_S		-	-	-16	A

Notes:

1. Repetitive Rating: Pulse width limited by maximum junction temperature.
2. Surface Mounted on FR4 Board, $t \leq 10$ sec.
3. Pulse Test: Pulse Width $\leq 300\mu s$, Duty Cycle $\leq 2\%$.
4. Guaranteed by design, not subject to production

TYPICAL ELECTRICAL AND THERMAL CHARACTERISTICS

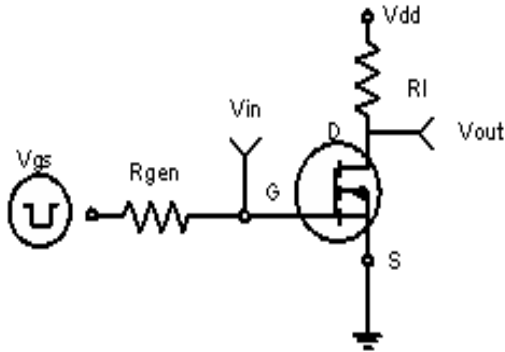

Figure 1: Switching Test Circuit

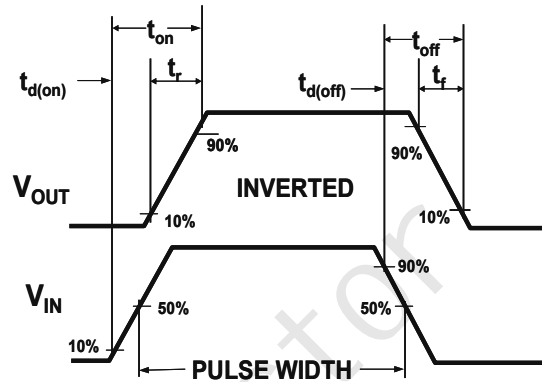

Figure 2: Switching Waveforms

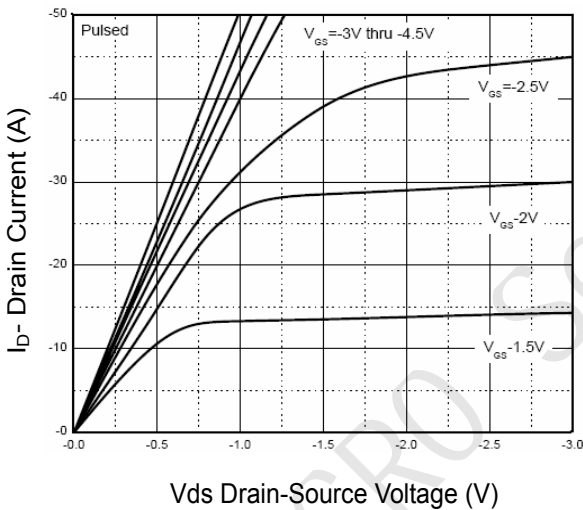

Figure 3 Output Characteristics

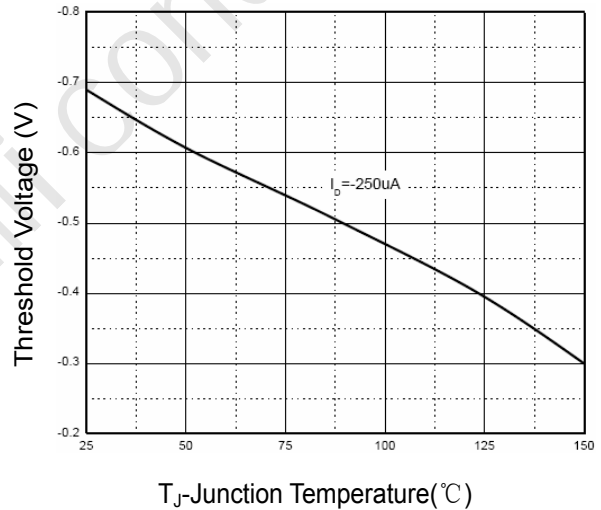

Figure 4 Drain Current

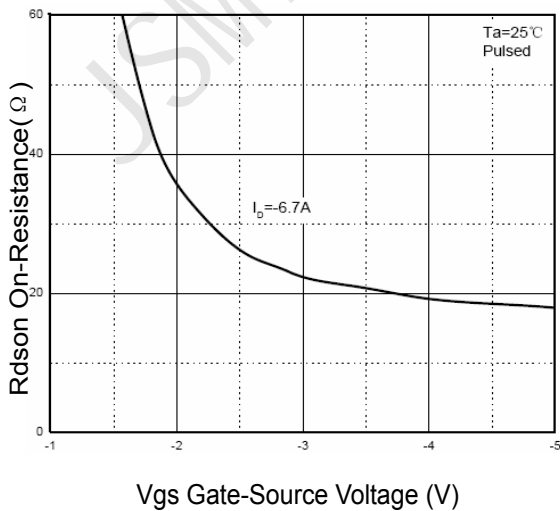

Figure 5 Rds(on) vs Vgs

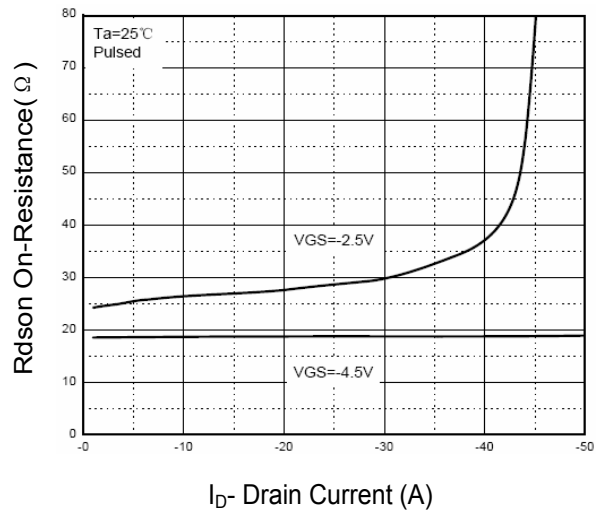
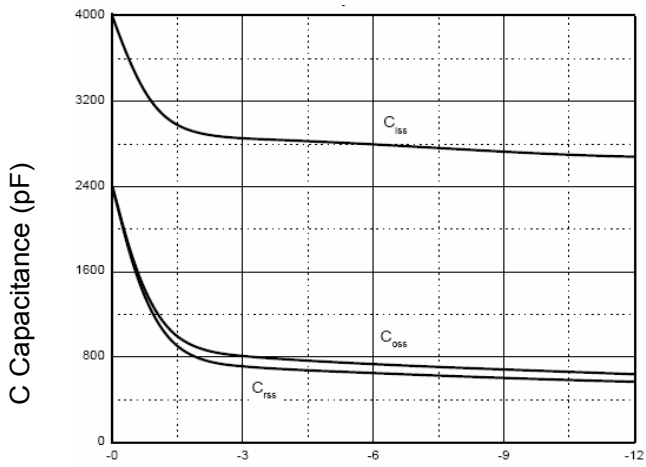
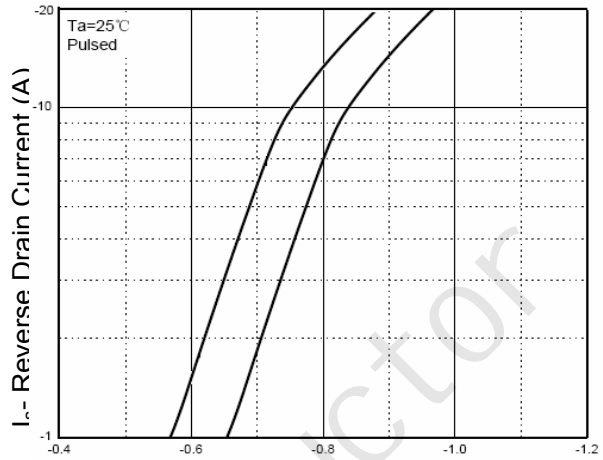

Figure 6 Drain-Source On-Resistance



V_{ds} Drain-Source Voltage (V)
Figure 7 Capacitance vs V_{ds}

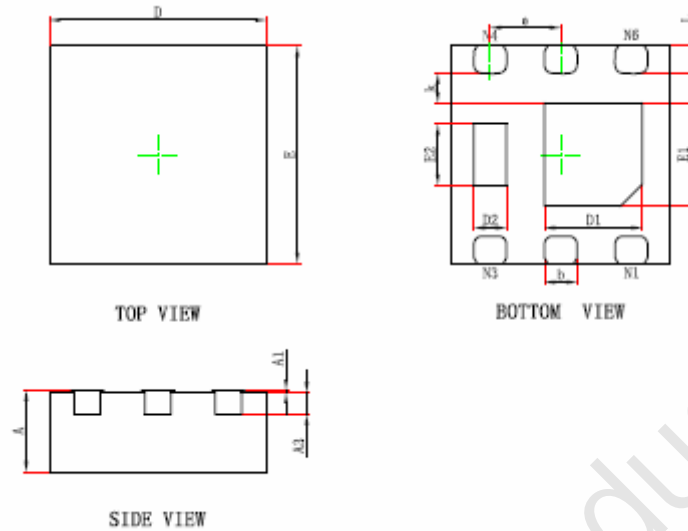

V_{sd} Source-Drain Voltage (V)
Figure 8 Source- Drain Diode Forward

DFN2X2-6L Package Information

Symbol	Dimensions In Millimeters		Dimensions In Inches	
	Min.	Max.	Min.	Max.
A	0.700	0.800	0.028	0.031
A1	0.000	0.050	0.000	0.002
A3	0.203REF.		0.008REF.	
D	1.924	2.076	0.076	0.082
E	1.924	2.076	0.076	0.082
D1	0.800	1.000	0.031	0.039
E1	0.850	1.050	0.033	0.041
D2	0.200	0.400	0.008	0.016
E2	0.460	0.660	0.018	0.026
k	0.200MIN.		0.008MIN.	
b	0.250	0.350	0.010	0.014
e	0.650TYP.		0.026TYP.	
L	0.174	0.326	0.007	0.013

Notes

1. All dimensions are in millimeters.
2. Tolerance $\pm 0.10\text{mm}$ (4 mil) unless otherwise specified
3. Package body sizes exclude mold flash and gate burrs. Mold flash at the non-lead sides should be less than 5 mils.
4. Dimension L is measured in gauge plane.
5. Controlling dimension is millimeter, converted inch dimensions are not necessarily exact.