

FEATURES

Programmable Output Voltage to 40V
 Low Dynamic Output Impedance 0.27 (Typ)
 Sink Current Capability of 0.1mA to 100 mA
 Equivalent Full-Range temperature Coefficient of 50 ppm/
 Temperature Compensated for Operation over Full Rated Operating Temperature Range
 Low Output Noise Voltage
 Fast Turn on Response
 S O T - 2 3 p a c k a g e s

DESCRIPTION

The TL431 is a three-terminal adjustable regulator series with a guaranteed thermal stability over applicable temperature ranges. The output voltage may be set to any value between Vref (approximately 2.5 volts) and 40 volts with two external resistors. These devices have a typical dynamic output impedance of 0.2 . Active output circuitry provides a very sharp turn-on characteristic, making these devices excellent replacement for zener diodes in many applications.

The TL431 is characterized for operation from -0 to +70 .

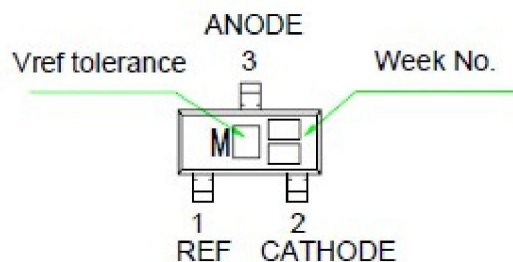
SOT-23

Pin Configuration

Symbol Diagram and Block Diagram

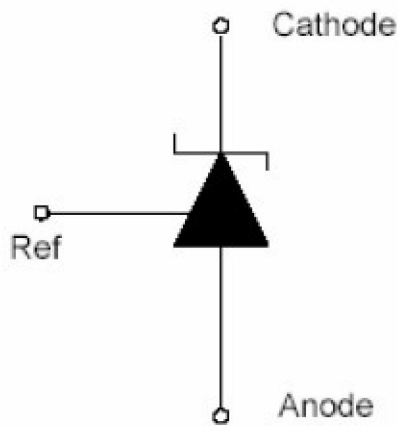

Symbol Diagram

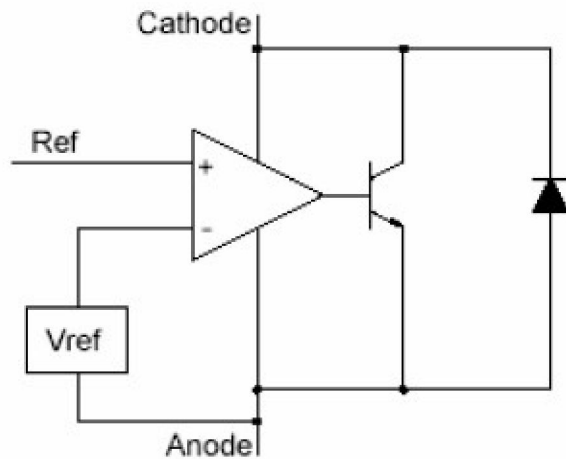

Block Diagram

Absolute Maximum Ratings (Operating temperature range applies unless otherwise specified)			
Characteristic	Symbol	Value	Unit
Cathode Voltage	V_{KA}	40	V
Continuous Cathode Current Range	I_K	-100 ~ 150	mA
Reference Input Current Range	I_{REF}	0.05 ~ 10	mA
Power Dissipation at 25 °C : TO-92 package ($R_{JA}=178 \text{ } \mu\text{W/W}$) SOT-23-3 Package ($R_{JA}=625 \text{ } \mu\text{W/W}$)	PD	0.7 0.2	W W
Junction Temperature Range	T_J	0 ~ 150	
Operating Temperature Range	T_g	0 ~ 70	
Storage Temperature Range	T_{STG}	-65 ~ 150	

Recommended Operating Conditions					
Characteristic	Symbol	Min	Typ	Max	Unit
Cathode current	I_K	0.5		100	mA
Cathode voltage	V_{KA}	V_{REF}		40	V

Parameter Measurement Information

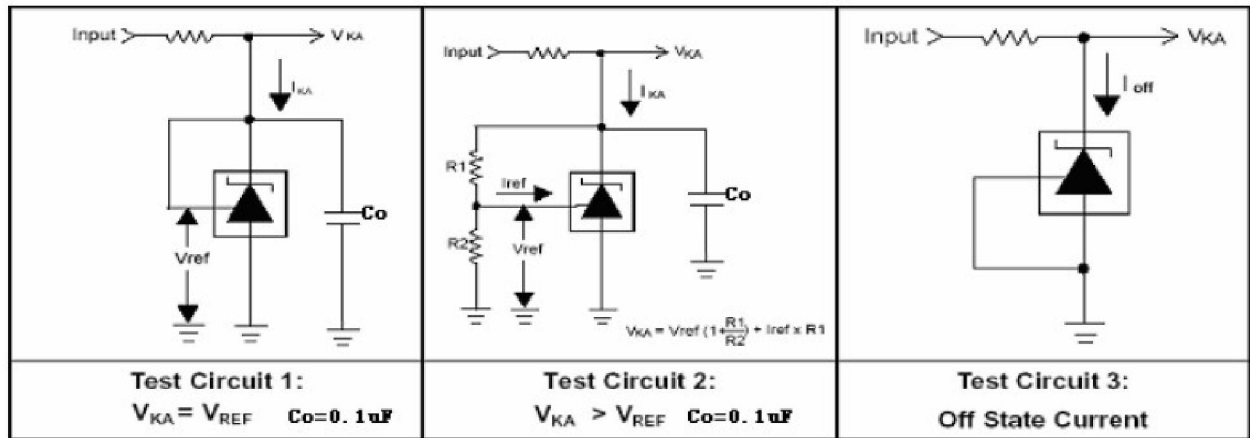

Electrical Characteristics						
$T_A = 25$, $V_{KA} = V_{REF}$, $I_K = 10$ mA unless otherwise noted						
Parameter	Symbol	Test Conditions	Min.	Typ.	Max.	Unit
Reference Input Voltage	V_{REF}	$I_K = 10$ mA, $V_{KA} = V_{REF}$	2.483	2.495	2.507	V
Deviation of Reference Input Voltage over Full Temperature Range	V_{REF}	T_{min} T_a T_{max}	-	3	17	mV
Ratio of Change in Reference Input Voltage to the Change in Cathode Voltage	$\frac{V_{REF}}{V_{KA}}$	$V_{KA} = 10$ V to V_{REF}	-0.4	0.0	2.7	mV/V
		$V_{KA} = 36$ V to 10 V	-0.4	0.0	2.0	
Reference Input Current	I_{REF}	$R1 = 10$ K, $R2 =$	-	1.8	4	μ A
Deviation of Reference Current over Full Temperature Range	$I_{i(DEV)}$	$R1 = 10$ K, $R2 =$	-	0.4	1.2	μ A
Minimum Cathode Current for Regulation	I_{Kmin}		-	0.25	0.5	mA
Off-State Cathode Current	$I_{K off}$	$V_{KA} = 40$ V $V_{REF} = 0$	-	0.17	0.9	μ A
Dynamic Impedance	Z_{KA}	$I_K = 10$ mA to 100 mA, $f = 1.0$ kHz	-	0.27	0.5	

SOT-23 Package information

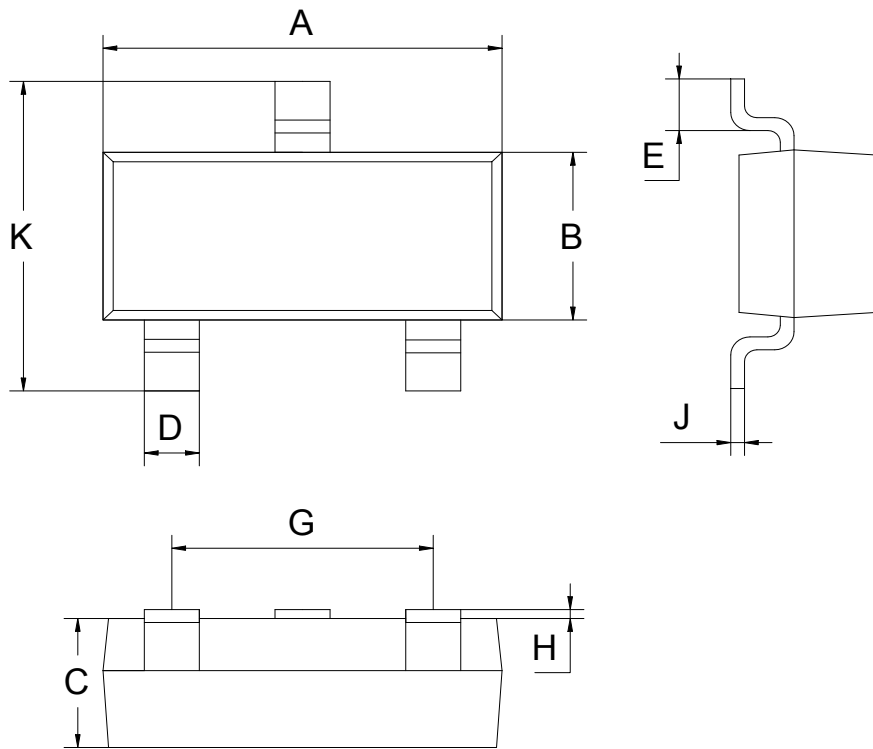

SOT-23			
Dim	MIN	NOM	MAX
A	2.80	2.90	3.00
B	1.20	1.30	1.40
C	0.90	1.00	1.10
D	0.39	0.40	0.45
E	0.20MIN		
G	1.90REF		
H	0.00	-	0.10
J	0.05	0.10	0.15
K	2.30	2.40	2.50
All Dimensions in mm			