

NOTE:

- Rating1:DC12V 3A  
Rating2:48V DC/125V AC/250V AC 0.1A
- Operating force:120gf MAX
- Electric Life:100,000
- Mechanical Life:500,000
- Ingress protection:IP67

ITEM	PART NAME	TER'NO.	QTY.	MATERIAL	FINISHING	REMARK
⑧	Handle	—	1	SUS	—	—
⑦	Shrapnel	—	1	Brass	Plating silver	—
⑥	Contact	—	1	Ag	—	—
⑤	Sealed Circle	—	1	Silicone Rubber	—	—
④	Terminal	—	2	Brass(0.50t)	Plating silver	—
③	Plunger	—	1	POM	Black	—
②	Case	—	1	PA	Black	—
①	Cover	—	1	PA	Black	—

APPROVALS		DATE		HRO 韩荣® ELECTRONICS CO.,LTD		
DRAWN	LIUCAN	2021.6.24		TITLE:	MICRO SWITCHS	
CHECKED				PART NO.	K9-2841L-6WCM-1B	
APPROVALS				UNIT: mm	SCALE: 1:1	PROJ:
TOLERANCES ARE	30~以上 ±0.30 10~30 ±0.20 5~10 ±0.15 ~ 5 ±0.10	ANGLE	±2'	DRAWING NO.		SHEET 1 OF 1

ECN NO.	REV.	DATE.	DESCRIPTION.	CHANGE.	CHECK.	APPRO.
	A		NEW			

# K9-284□选型表

## K9-2841N-1SDA-1A



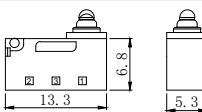









开关系列	名称
K9	防水微动开关

编码	图示	产品规格
4		D型 13.3*5.3*6.8(帽型导芯)

编码	额定负载
1	3A 12V DC
	0.1A 125/250V AC
	0.1A 48V DC
2	10(1.5)A 250V AC









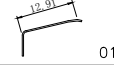
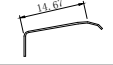

编码	图示	定位类型
N		无定位柱
R		右侧双定位柱
L		左侧双定位柱
D		两侧双定位柱
Q		其它

编码	定位柱长度L
0	无定位柱
1	1.5MM
2	2.0MM
3	2.5MM
4	3.0MM
5	3.5MM
6	5.0MM
7	1.3MM

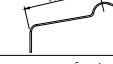
编码	端子类型	编码	端子类型
S		T	
H		E	
B		W	
P		X	
K		Y	
M			
L			
R			





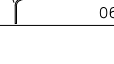
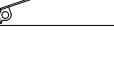





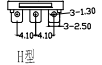
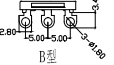
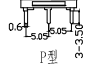
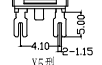
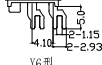
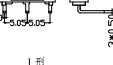
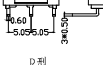
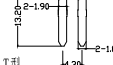









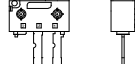



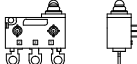

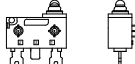
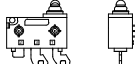

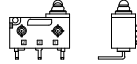
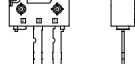

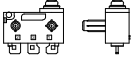
编码	线材长度L	编码	线材长度L
0	无线材省略	C	250mm
A	150mm	D	300mm
B	200mm	其它	...

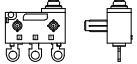
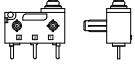
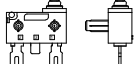
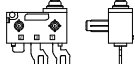
流水号	电线规格	流水号	电线规格
0	无线材省略	5	0.14mm <sup>2</sup> *6C
1	UL1007 22AWG美标	6	UL1007 24AWG美标
2	AVSS0.3日标	7	特氟龙24AWG
3	AVSS0.5日标	8	VW-1 1015 20AWG
4	UL1007 20AWG美标	9	UL2468 24AWG VW-1 80℃

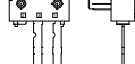
编码	手柄类型	编码	手柄类型	编码	手柄类型
A		F		J	
B		G		K	
C		H		L	
D		Q		M	
E		P		N	无手柄



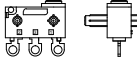
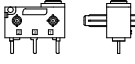
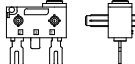
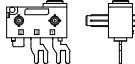
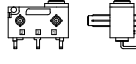

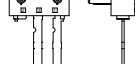
编码	触点类型
D	常开/常闭 SPDT
B	常开 SPST-NO
C	常闭 SPST-NC

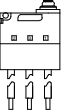
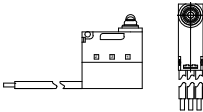
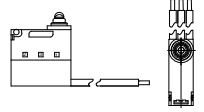
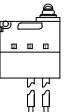
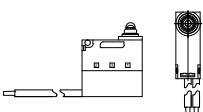
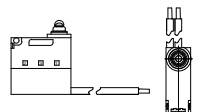
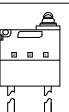
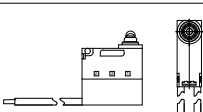
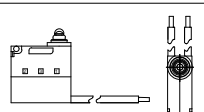
# D型 选型表

端子类型 定位柱类型		S型	H型	B型	P型	K型	M型	L型	R型	T型	其他/Other
											其他/Other
N											
R											
L											
D											
备注：定位柱长度"L"通常为1.5MM、2.0MM、2.5MM、3.0MM、3.5MM、5.0MM，也可根据客户需求定制长度											

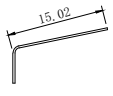
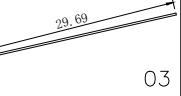
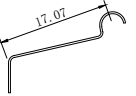
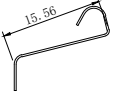
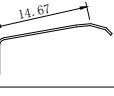
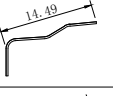
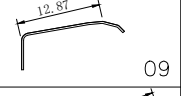
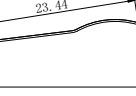
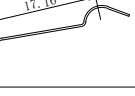
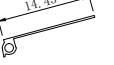
端子类型 触点类型		W	X	Y
D 常开/常闭				
B 常开				
C 常闭				

## 手柄类型

手柄	插入式	 01	 02	 03	 05	 06
	外扣式	 07	 08	 09	 22	 23
		 26	 28	 27	 19	