

MAPX	MODIFICATION	DATE	DRAW	APPROVE

TABLE 2:

TYPEC-342-ACP24X7SC14	鍍層PLATING :Au15u"	PAINT顏色	9.8	4.02
PART NO.	鍍層PLATING SPC.	註釋REMARK	DIM"A"	DIM"B"

NOTES:

- MATERIAL: SEE "TABLE 1";
- FINISH: SEE "TABLE 1";
- ELECTRICAL :
  - CONTACT CURRENT RATING :
    - 5A(VBUS PIN 1.5A/PIN),
    - 5A(GND PIN 1.25A/PIN MAX),0.25A/PIN(OTHER PIN).
  - INSULATION RESISTANCE :
    - 100 MEGAOHMS MIN. AT 250VDC.
  - DIELECTRIC WITHSTANDING VOLTAGE :
    - 100VAC MIN.
  - LOW LEVEL CONTACT RESISTANCE :
    - INITIAL 40mΩ MAX.
    - AFTER 50mΩ MAX.
- MECHANICAL CHARACTERISTICS :
  - MATING FORCE: 5~20N,
  - UNMATING FORCE:
    - 8~20N(INITIAL),6~20N(AFTER 10000 CYCLES);
  - DURABILITY : 10,000 MATING CYCLES.
  - OPERATING TEMPERATURE : -40°C TO +80°C

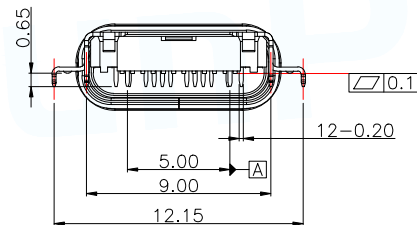
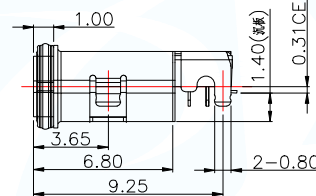
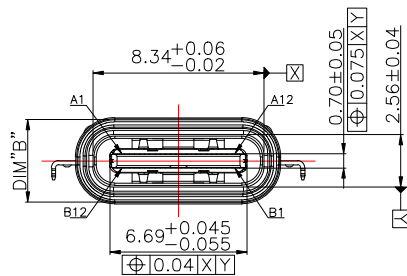
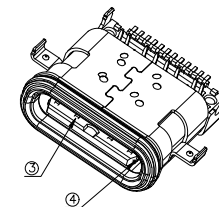
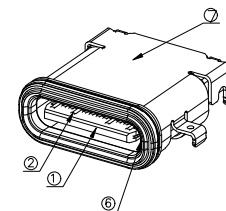
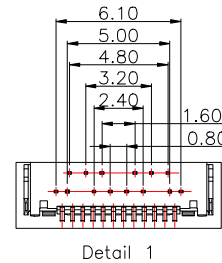
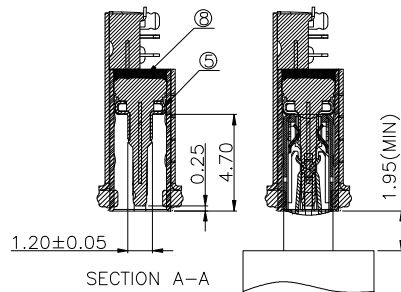
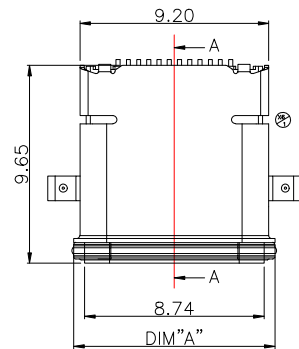

Pin	Signal Name	Mating Sequence	Pin	Signal Name	Mating Sequence
A1	GND	First	B12	GND	First
A2	SSTXp1	Second	B11	SSRXp1	Second
A3	SSTXn1	Second	B10	SSRXn1	Second
A4	VBUS	First	B9	VBUS	First
A5	CC1	Second	B8	SBU2	Second
A6	Dp1	Second	B7	Dn2	Second
A7	Dn1	Second	B6	Dp2	Second
A8	SBU1	Second	B5	CC2	Second
A9	VBUS	First	B4	VBUS	First
A10	SSRXn2	Second	B3	SSTXn2	Second
A11	SSRXp2	Second	B2	SSTXp2	Second
A12	GND	First	B1	GND	First
SHELL	GND		SHELL	GND	

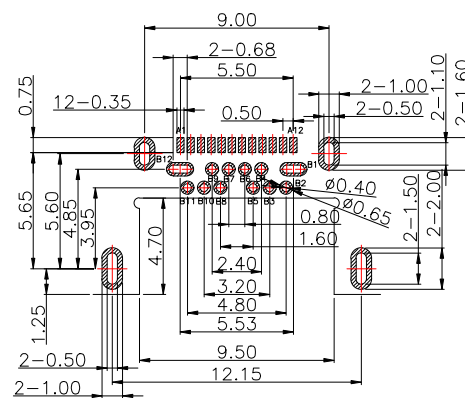
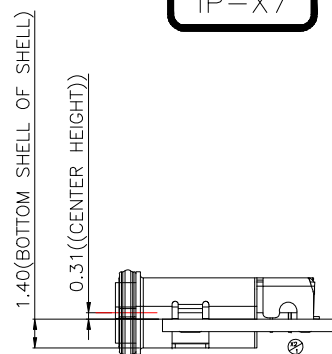
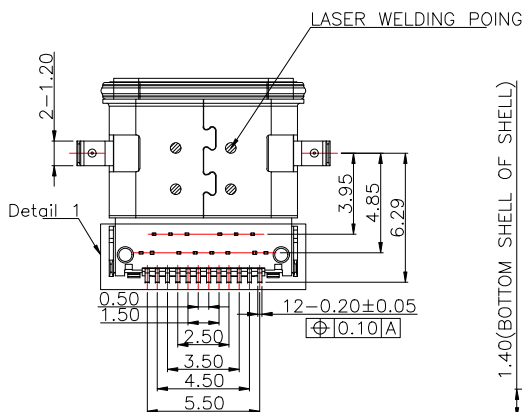

RECOMMENDED P.C.B LAYOUT(Both sides are sample)  
Tolerance:±0.05,Thickness=0.60mm

TABLE 1:

NO.	PART NAME	QTY	MATERIAL	DESCRIPTION	REMARK
⑧	GLUE WATER	1	EPOXY	BLACK;	
⑦	Shell-2	1	Stainless steel	NI PLATING;	T=0.20mm
⑥	Shell-1	1	Stainless steel	NI PLATING;	T=0.20mm
⑤	GND PLATE	1	Stainless steel	NI PLATING;	T=0.10mm
④	MID PLATE	1	Stainless steel		T=0.15mm
③	Terminal-B	12	銅鍍硅合金	TABLE 2	T=0.12mm
②	Terminal-A	12		TABLE 2	T=0.12mm
①	Housing	1	HIGH TEMP	Black	

MANUFACTURE DWG		东莞市讯普电子科技有限公司 DongGuan XunPu Electronics Co.,Ltd	
UNLESS OTHERWISE SPECIFIED TOLERANCES			TITLE:USB 3.1 CF WATERPROOF CL=0.30 板厚1.40mm DIP TYPE
DECIMALS:	ANGLES:		PAR
X.:±0.38	X'.:±5°	DWN	
.X:±0.30	X.X':±3°	CHKD	
.XX:±0.20	X.XX':±1°	APVD	
CUSTOMER COPY		SCALE1:1	UNIT:MM
		SIZE:A4	SHEET:1F1
			REV:A

# 建议密封方式

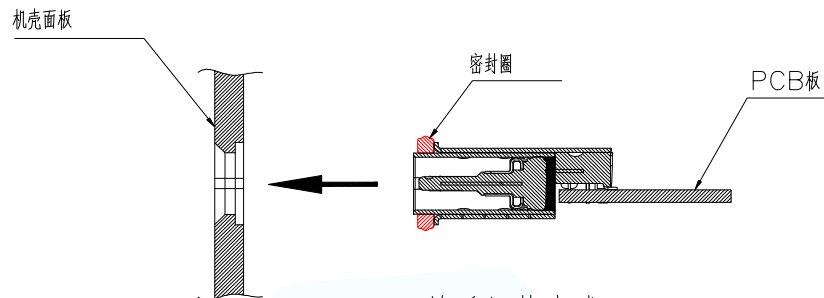

前后组装方式

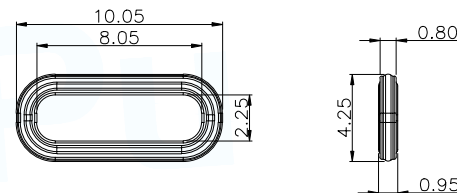

建议防水圈规格 (材质硅橡胶)

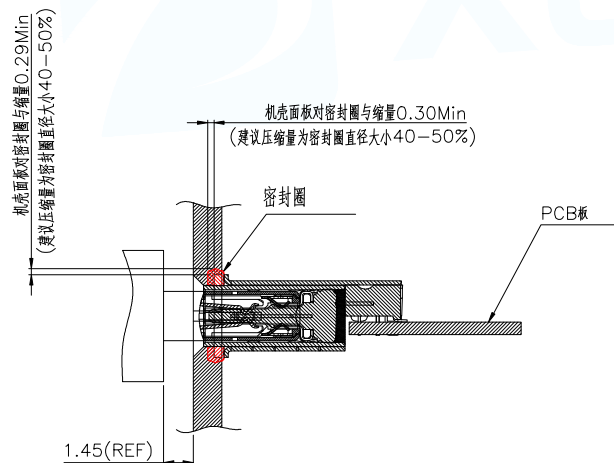

组装面板后公母头对插示意图

MANUFACTURE DWG		东莞市讯普电子科技有限公司 DongGuan XunPu Electronics Co.,Ltd	TITLE:USB 3.1 CF WATERPROOF CL=0.30 沉板1.40mm DIP TYPE	
UNLESS OTHERWISE SPECIFIED TOLERANCES			PAR	TYPEC-342-ACP24X75C14
DECIMALS:	ANGLES:	DWN		
X.:±0.38	X'.:±5°	CHKD		
.X:±0.30	X.X':±3"	APVD		
.XX:±0.20	X.XX':±1"	SCALE1:1	UNIT:MM	
		SIZE:A4	SHEET:1F1	
		CUSTOMER COPY	REV:A	

