



FEATURES

- VDD range: 2.7V to 5.5V
- Low Offset Voltage: 0.5mV (Typical)
- Low Drift: $0.65\mu\text{V}/^\circ\text{C}$ (Typical)
- Low Noise
- Quiescent Current: $28\mu\text{A}$
- Rail to Rail Input/Output
- MicroSize Packages: SC70 and SOT23
- -40°C to 125°C Operation

APPLICATIONS

- Transducers
- Temperature Measurement
- Electronic Scales
- Medical instrumentation
- Handheld Test Equipment

GENERAL DESCRIPTION

The MT0321 is a CMOS operational amplifier that uses the proprietary auto-calibration technique to simultaneously provide very low offset voltage, near-zero drift over time and temperature. These miniature, high-precision, low quiescent current amplifiers offer high-impedance inputs that have a common-mode range 200mV beyond the rails, and rail-to-rail output that swings within 50mV of the rails, single or dual supplies as low as $2.7\text{V}(\pm 1.35\text{V})$ and up to $5.5\text{V}(\pm 2.75\text{V})$ can be used. These devices are optimized for low voltage, single supply operation.

The MT0321 offers excellent CMRR without the crossover associated with traditional complementary input stages. This design results in superior performance for driving analog-to-digital converters (ADCs) without degradation of differential linearity. The MT0321 is available in the 5-pin SOT-23 and SOT70 packages, and specified for operation from -40°C to 125°C .

SIMPLIFIED SCHEMATIC

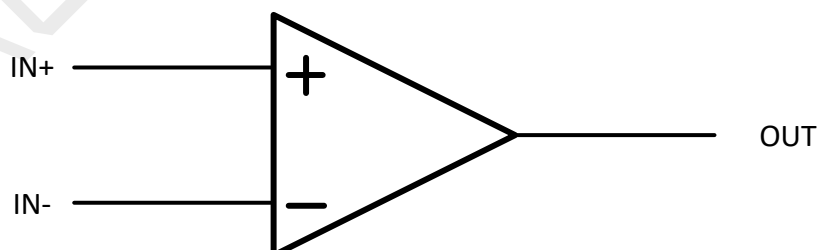

Figure 1. Simplified Schematic

ABSOLUTE MAXIMUM RATINGS (Note 1)

Thermal Resistance θ_{JC}130°C/W
 Supply Voltage.....2.7 to 5.5V
 Signal Input Terminals Voltage...-0.1 to (V+)+0.1V
 Operating Junction Temperature.....125°C
 Operating Temperature Range.....-40°C to 125°C
 Storage Temperature-65°C to 150°C

PACKAGE/ORDER INFORMATION

<p>TOP VIEW</p> <p>1IN+ 1 5 V_{CC+} GND 2 1IN- 3 4 OUT</p>	Order Part Number	Package	Top Marking
	MT0321	5-Pin SOT23 5-Pin SC70	MT0321 <u>AC</u> MT0321 <u>CD</u>

DEVICE INFORMATION

Order Part Number	Top Marking	Package
MT0321	MT0321 <u>AC</u>	SOT23-5
	MT0321 <u>CD</u>	SC70-5 (SOT353)

PIN DESCRIPTION

Pin Name	Pin Number	Description
+IN	1	Noninverting input
GND	2	Negative (lowest) power supply
-IN	3	Inverting input
OUT	4	Output
V _{CC+}	5	Positive (highest) power supply

ELECTRICAL CHARACTERISTICS (Note 3)

(At $T_A = 25^\circ\text{C}$, $R_L = 10\text{k}\Omega$ connected to $V_S/2$, and $V_{OUT} = V_S/2$, unless otherwise noted.)

PARAMETER	CONDITIONS	MIN	TYP	MAX	UNIT
Input Offset Voltage	$V_S = \pm 2.5\text{V}$		0.5		mV
Input Offset Voltage Drift	$T_A = -40^\circ\text{C}$ to 125°C		0.65		$\mu\text{V}/^\circ\text{C}$
Power Supply Rejection Ratio	$V_S = 2.7\text{V}$ to 5.5V $T_A = -40^\circ\text{C}$ to 125°C		88		dB
Input Bias Current	$T_A = 25^\circ\text{C}$		1.7		pA
Input Offset Current			2.7		pA
Common-mode Voltage Range		(V-)-0.1		(V+)+0.1	V
Common-mode Rejection Ratio	$(V-)-0.1 < V_{CM} < (V+)+0.1$ $T_A = -40^\circ\text{C}$ to 125°C		95		dB
Open Loop Voltage Gain	$(V+)+100\text{mV} < V_O < (V+)-100\text{mV}$, $R_L = 10\text{k}\Omega$ $T_A = -40^\circ\text{C}$ to 125°C		101		dB
Gain-bandwidth product	$C_L = 100\text{pF}$		1.7		MHz
Slew Rate	$G = +1$		1.3		$\text{V}/\mu\text{s}$
Specified Voltage Range		2.7		5.5	V
Quiescent Current	$I_O = 0\text{A}$		28		μA
Operating Temperature Range		-40		125	$^\circ\text{C}$
Storage Temperature Range		-65		150	$^\circ\text{C}$

Note 1: Absolute Maximum Ratings are those values beyond which the life of a device may be impaired.

Note 2: T_J is calculated from the ambient temperature T_A and power dissipation P_D according to the following formula: $T_J = T_A + (P_D) \times (170^\circ\text{C}/\text{W})$.

Note 3: 100% production test at $+25^\circ\text{C}$. Specifications over the temperature range are guaranteed by design and characterization.

TYPICAL PERFORMANCE CHARACTERISTICS

(At $T_A = 25^\circ\text{C}$, $V_S = 5\text{V}$, $C_L = 0\text{pF}$, unless otherwise noted.)

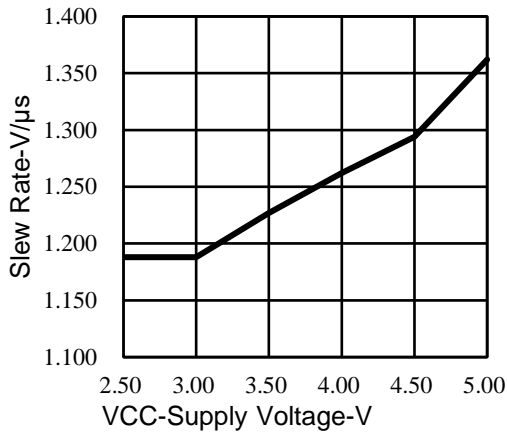

Figure 2. Slew Rate vs Supply Voltage

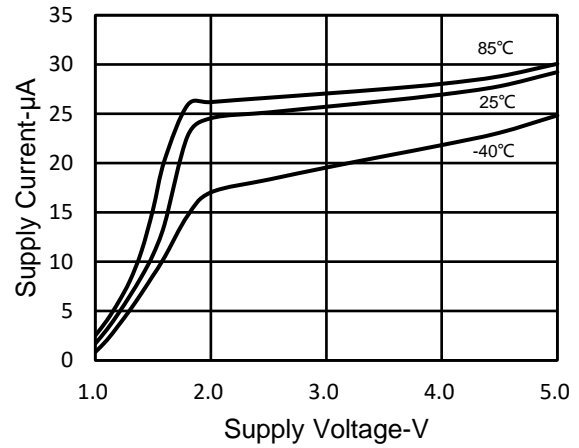

Figure 3. Supply Current vs Supply Voltage

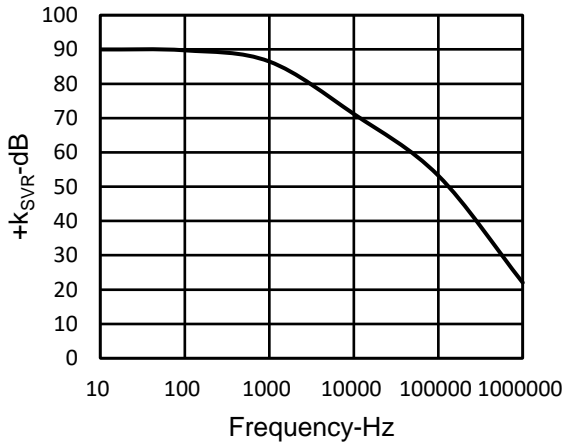

Figure 4. $+k_{SVR}$ vs Frequency

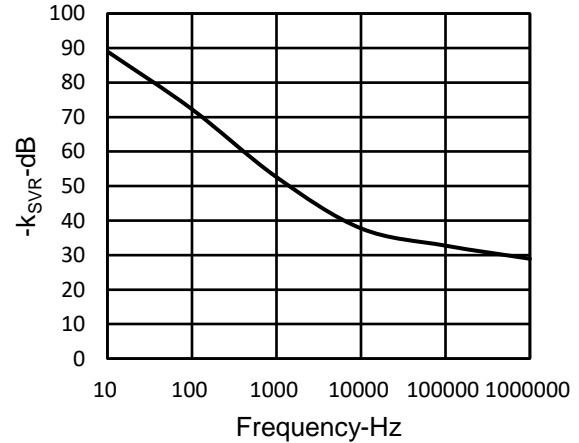

Figure 5. $-k_{SVR}$ vs Frequency

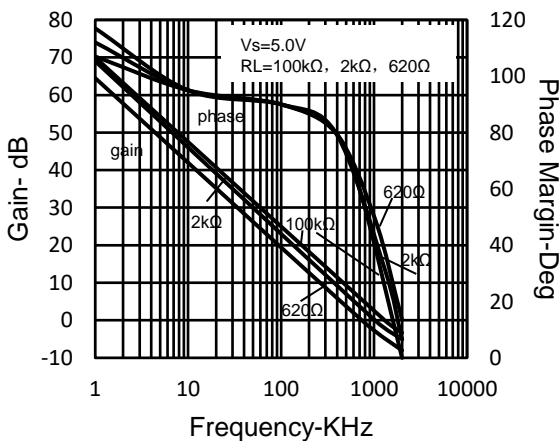

Figure 6. Frequency Response vs Resistive Load

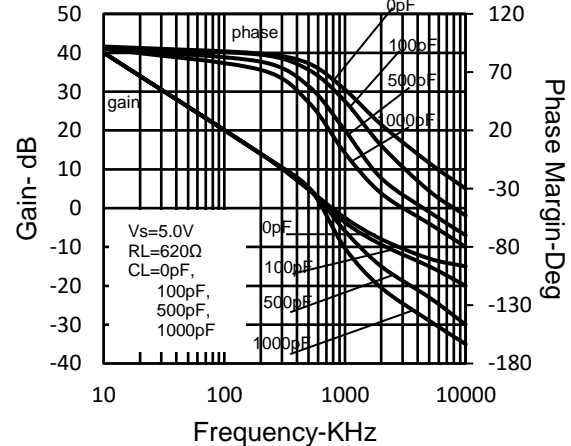
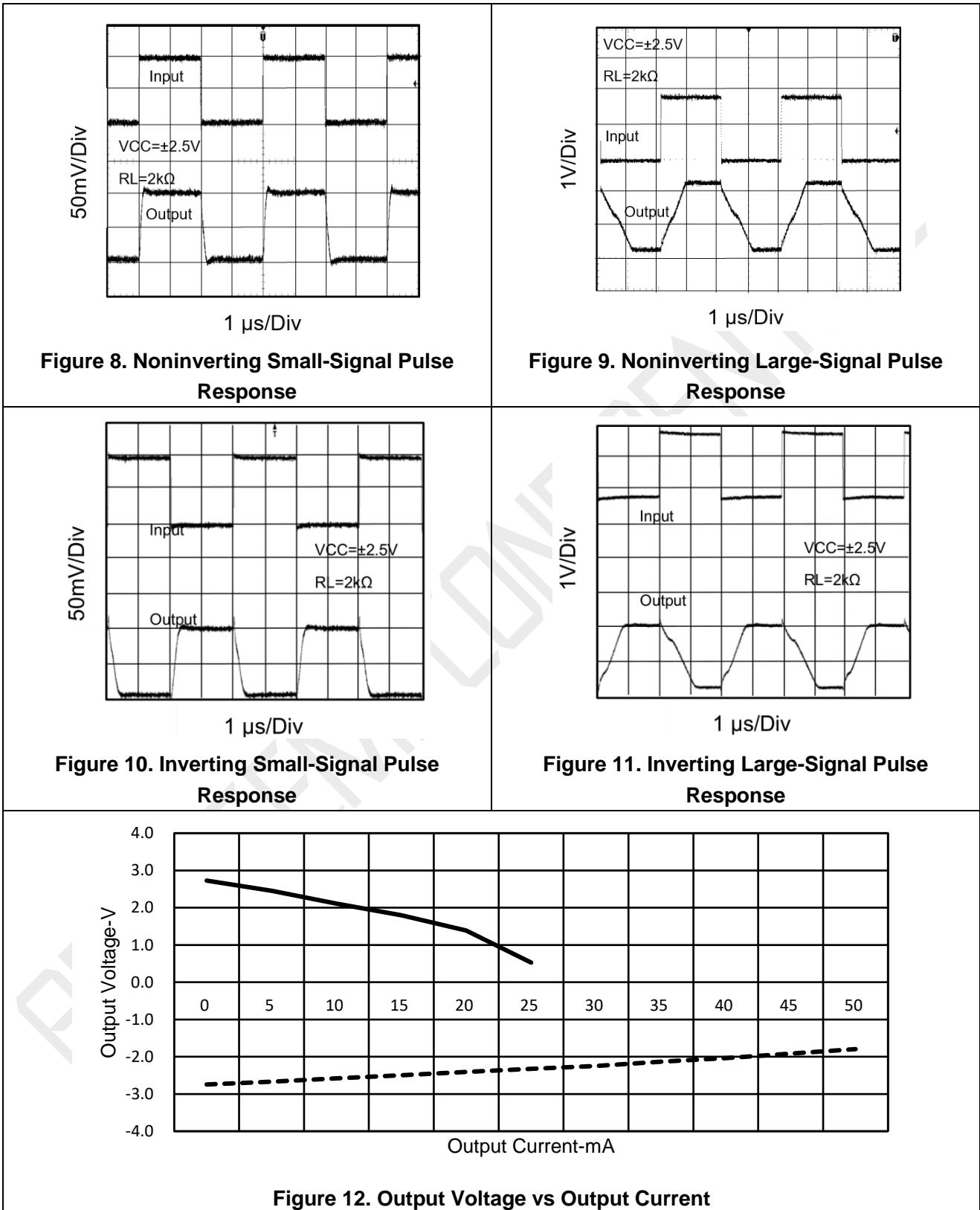

Figure 7. Frequency Response vs Capacitive Load

TYPICAL PERFORMANCE CHARACTERISTICS



FUNCTIONAL DESCRIPTION

Operating Voltage

The MT0321 devices are fully specified and ensured for operation from 2.7 V to 5.5 V. In addition, many specifications apply from -40°C to 125°C . Parameters that vary significantly with operating voltages or temperature are shown in the Typical Characteristics graphs.

Unity-Gain Bandwidth

The unity-gain bandwidth is the frequency up to which an amplifier with a unity gain may be operated without greatly distorting the signal. The MT0321 devices have a 1.7-MHz unity-gain bandwidth.

APPLICATIONS INFORMATION

The MT0321 is a unity-gain stable, precision operational amplifier with very low offset voltage drift; these devices are also free from output phase reversal. Applications with noisy or high-impedance power supplies require decoupling capacitors close to the device power-supply pins. In most cases, $0.1\mu\text{F}$ capacitors are adequate.

Typical Application

Figure 13 shows a simple circuit to convert a single-ended input into differential output. The MT0321 could be used to build this circuit. The circuit is composed of two amplifiers. One amplifier acts as a buffer and creates a voltage, $V_{\text{OUT}+}$. The second amplifier inverts the input and adds a reference voltage to generate $V_{\text{OUT}-}$. Both $V_{\text{OUT}+}$ and $V_{\text{OUT}-}$ range from 0.5 to 2 V. The difference, V_{DIFF} , is the difference between $V_{\text{OUT}+}$ and $V_{\text{OUT}-}$.

Slew Rate

The slew rate is the rate at which an operational amplifier can change its output when there is a change on the input. The MT0321 devices have a $1.32\text{-V}/\mu\text{s}$ slew rate. The MT0321 is characterized to perform with this technique; the recommended resistor value is approximately $20\text{ k}\Omega$.

Device Functional Modes

The MT0321 device has a single functional mode. The device is powered on as long as the power supply voltage is between $2.7\text{V}(\pm 1.35\text{V})$ and $5.5\text{V}(\pm 2.75\text{V})$.

Detailed Design Procedure

Linearity over the input range is key for good dc accuracy. The common mode input range and the output swing limitations determine the linearity. In general, an amplifier with rail-to-rail input and output swing is required. Bandwidth is a key concern for this design. Because MT0321 has a bandwidth of 1 MHz, this circuit will only be able to process signals with frequencies of less than 1 MHz.

Because the transfer function of $V_{\text{OUT}-}$ is heavily reliant on resistors (R1, R2, R3, and R4), use resistors with low tolerances to maximize performance and minimize error. This design used resistors with resistance values of $36\text{ k}\Omega$ with tolerances measured to be within 2%. If the noise of the system is a key parameter, the user can select smaller resistance values ($6\text{ k}\Omega$ or lower) to keep the overall system noise low. This ensures that the noise from the resistors is lower than the amplifier noise.

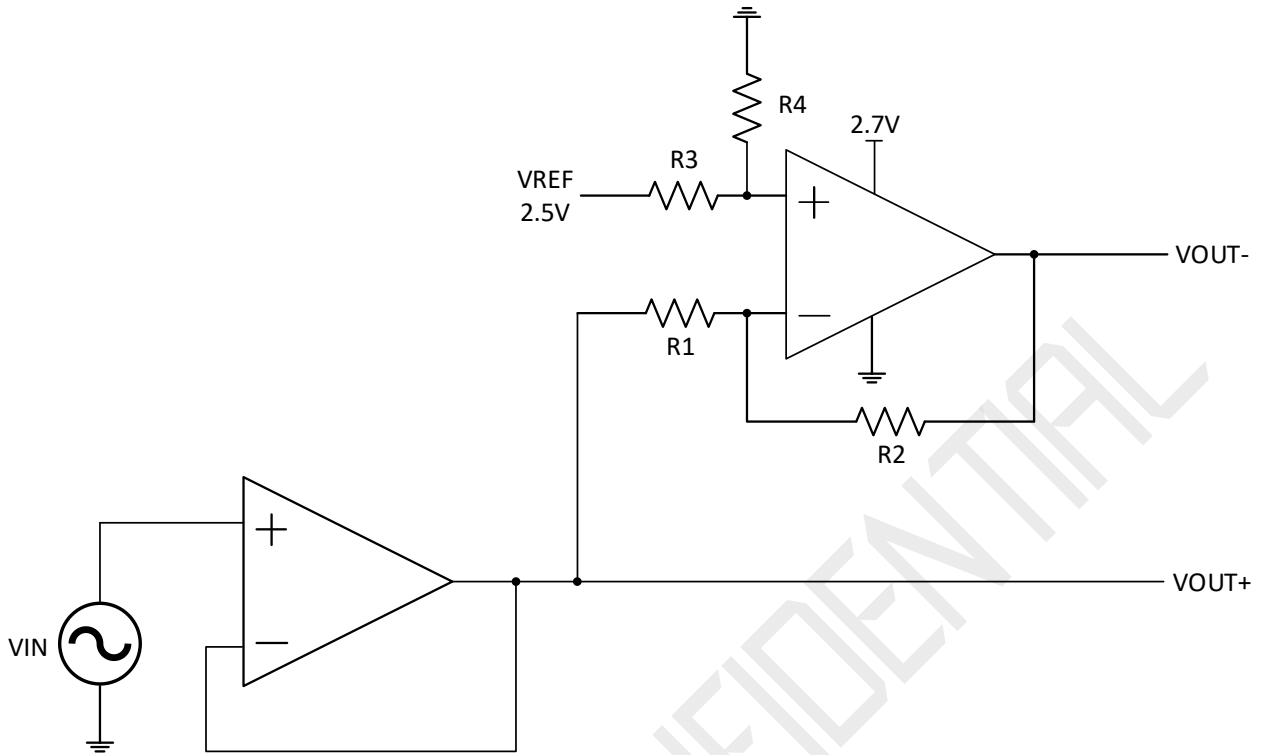
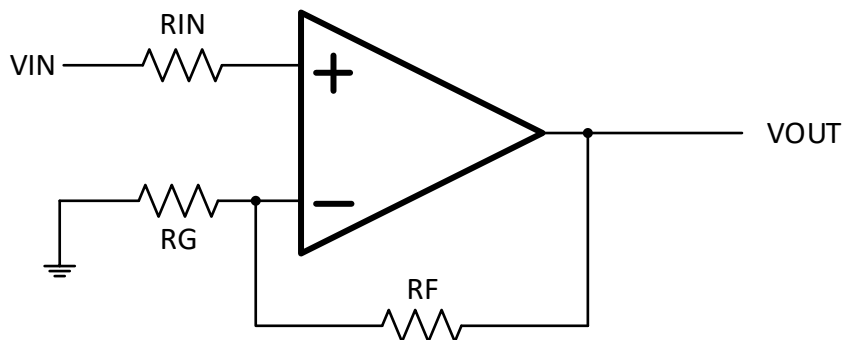

Figure 13. Schematic for Single-Ended Input to Differential Output Conversion

LAYOUT

Use good PCB layout practices for best operational performance of the device, including:

- Keep the length of input traces as short as possible.
- Run the input traces as far away from the supply lines as possible to reduce parasitic coupling.
- Place components close to device and to each other to reduce parasitic capacitance and parasitic errors.
- Use low-ESR, ceramic bypass capacitors to reduce the coupled noise by providing low impedance power sources local to the analog circuitry.
- Grounding for analog and digital portions of circuitry separately to suppress the noise.



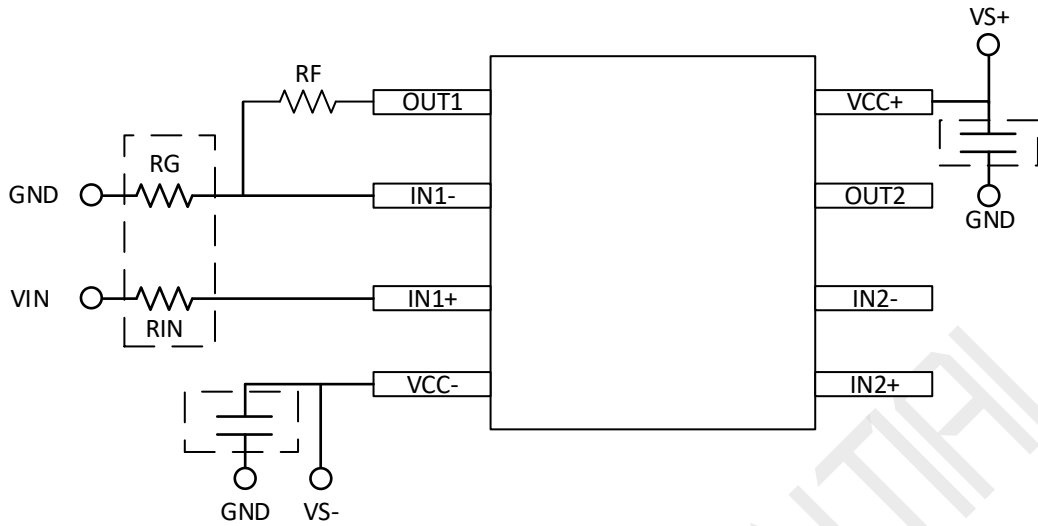
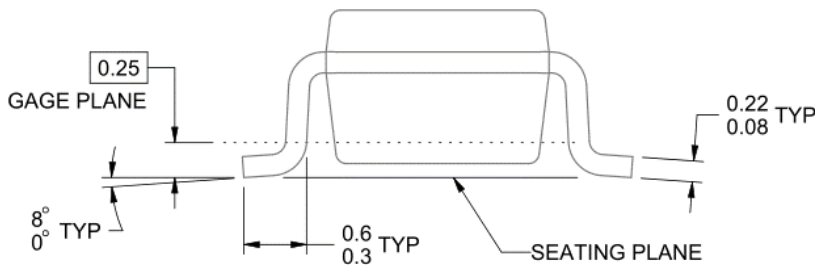
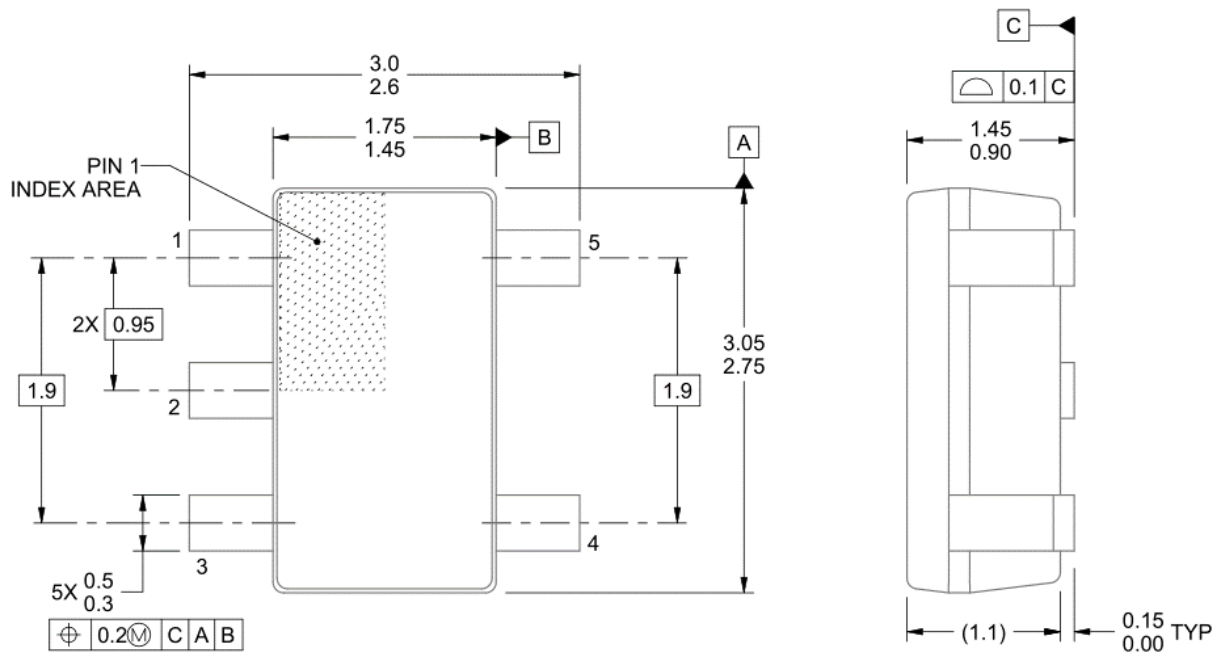

Figure 14. Operational Amplifier Schematic and Board Layout for Noninverting Configuration

AEROSEMI CONFIDENTIAL

PACKAGE DESCRIPTION

SOT-23



NOTES:

1. All linear dimensions are in millimeters. Any dimensions in parenthesis are for reference only. Dimensioning and tolerancing per ASME Y14.5M.
2. This drawing is subject to change without notice.
3. Reference JEDEC MO-178.
4. Body dimensions do not include mold flash, protrusions, or gate burrs. Mold flash, protrusions, or gate burrs shall not exceed 0.15 mm per side.

SC70

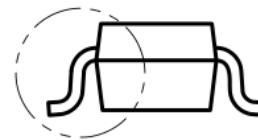
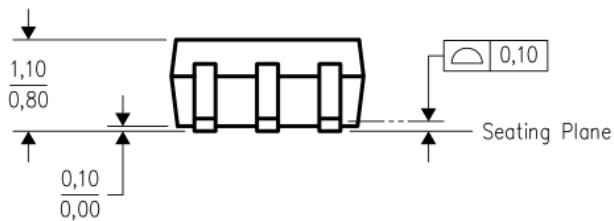
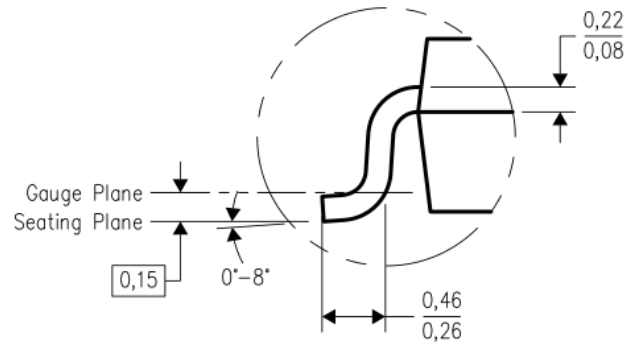
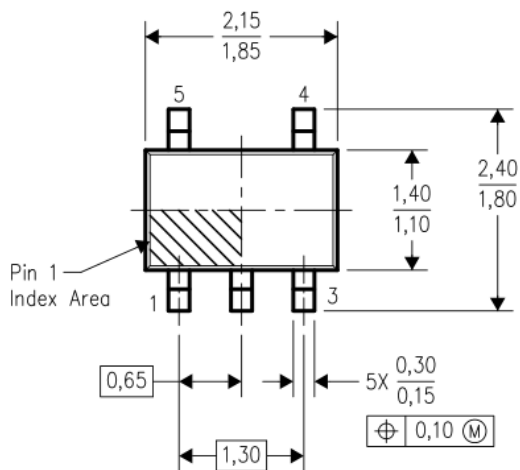

NOTES:

1. All linear dimensions are in millimeters.
2. This drawing is subject to change without notice.
3. Falls within JEDEC MO-203 variation AA.
4. Body dimensions do not include mold flash or protrusion. Mold flash and protrusion shall not exceed 0.15 per side.

IMPORTANT NOTICE

Xi'an Arosemi Technology Co.,Ltd reserve the right to make corrections, enhancements, improvements and other changes to its semiconductor products and services.

Xi'an Arosemi Technology Co.,Ltd is not responsible or liable for such altered documentation. Information of third parties may be subject to additional restrictions.

Xi'an Arosemi Technology Co.,Ltd does not assume any responsibility for use of any its products for any particular purpose, nor does Xi'an Arosemi Technology Co.,Ltd assume any liability arising out of the application or use of any its products or circuits.

Copyright © 2011, Xi'an Arosemi Technology Co.,Ltd

Support : 15216397288

[Http://www.arosemi.com](http://www.arosemi.com)

AEROSEMI CONFIDENTIAL