

MC14018B

Presettable Divide-By-N Counter

The MC14018B contains five Johnson counter stages which are asynchronously presettable and resettable. The counters are synchronous, and increment on the positive going edge of the clock.

Presetting is accomplished by a logic 1 on the preset enable input. Data on the Jam inputs will then be transferred to their respective \bar{Q} outputs (inverted). A logic 1 on the reset input will cause all \bar{Q} outputs to go to a logic 1 state.

Division by any number from 2 to 10 can be accomplished by connecting appropriate \bar{Q} outputs to the data input, as shown in the Function Selection table. Anti-lock gating is included in the MC14018B to assure proper counting sequence.

Features

- Fully Static Operation
- Schmitt Trigger on Clock Input
- Capable of Driving Two Low-Power TTL Loads or One Low-Power Schottky TTL Load Over the Rated Temperature Range
- Pin-for-Pin Replacement for CD4018B
- NLV Prefix for Automotive and Other Applications Requiring Unique Site and Control Change Requirements; AEC-Q100 Qualified and PPAP Capable
- This Device is Pb-Free and is RoHS Compliant

MAXIMUM RATINGS (Voltages Referenced to V_{SS})

Symbol	Parameter	Value	Unit
V_{DD}	DC Supply Voltage Range	-0.5 to +18.0	V
V_{in}, V_{out}	Input or Output Voltage Range (DC or Transient)	-0.5 to $V_{DD} + 0.5$	V
I_{in}, I_{out}	Input or Output Current (DC or Transient) per Pin	± 10	mA
P_D	Power Dissipation, per Package (Note 1)	500	mW
T_A	Ambient Temperature Range	-55 to +125	$^{\circ}\text{C}$
T_{stg}	Storage Temperature Range	-65 to +150	$^{\circ}\text{C}$
T_L	Lead Temperature (8-Second Soldering)	260	$^{\circ}\text{C}$

Stresses exceeding those listed in the Maximum Ratings table may damage the device. If any of these limits are exceeded, device functionality should not be assumed, damage may occur and reliability may be affected.

1. Temperature Derating: "D/DW" Packages: -7.0 mW/ $^{\circ}\text{C}$ From 65 $^{\circ}\text{C}$ To 125 $^{\circ}\text{C}$

This device contains protection circuitry to guard against damage due to high static voltages or electric fields. However, precautions must be taken to avoid applications of any voltage higher than maximum rated voltages to this high-impedance circuit. For proper operation, V_{in} and V_{out} should be constrained to the range $V_{SS} \leq (V_{in} \text{ or } V_{out}) \leq V_{DD}$.

Unused inputs must always be tied to an appropriate logic voltage level (e.g., either V_{SS} or V_{DD}). Unused outputs must be left open.



ON Semiconductor®

<http://onsemi.com>

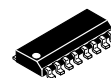

SOIC-16
D SUFFIX
CASE 751B

PIN ASSIGNMENT

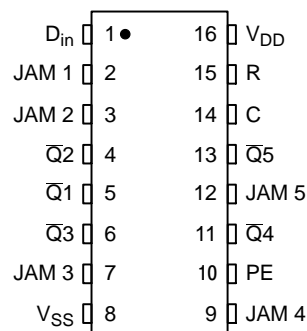

MARKING DIAGRAM

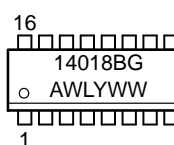

A = Assembly Location
WL, L = Wafer Lot
YY, Y = Year
WW, W = Work Week
G = Pb-Free Indicator

FUNCTIONAL TRUTH TABLE

Clock	Reset	Preset Enable	Jam Input	\bar{Q}_n
\sim	0	0	X	\bar{Q}_n
\sim	0	0	X	\bar{D}_n^*
X	0	1	0	1
X	0	1	1	0
X	1	X	X	1

* D_n is the Data input for that stage. Stage 1 has Data brought out to Pin 1.

ORDERING INFORMATION

See detailed ordering and shipping information in the package dimensions section on page 2 of this data sheet.

MC14018B

ELECTRICAL CHARACTERISTICS (Voltages Referenced to V_{SS})

Characteristic	Symbol	V _{DD} Vdc	-55°C		25°C			125°C		Unit
			Min	Max	Min	Typ (Note 2)	Max	Min	Max	
Output Voltage V _{in} = V _{DD} or 0	“0” Level V _{OL}	5.0	–	0.05	–	0	0.05	–	0.05	Vdc
		10	–	0.05	–	0	0.05	–	0.05	
15		–	0.05	–	0	0.05	–	0.05		
V _{in} = 0 or V _{DD}	“1” Level V _{OH}	5.0	4.95	–	4.95	5.0	–	4.95	–	Vdc
		10	9.95	–	9.95	10	–	9.95	–	
		15	14.95	–	14.95	15	–	14.95	–	
Input Voltage (V _O = 4.5 or 0.5 Vdc) (V _O = 9.0 or 1.0 Vdc) (V _O = 13.5 or 1.5 Vdc)	“0” Level V _{IL}	5.0	–	1.5	–	2.25	1.5	–	1.5	Vdc
		10	–	3.0	–	4.50	3.0	–	3.0	
15		–	4.0	–	6.75	4.0	–	4.0		
(V _O = 0.5 or 4.5 Vdc) (V _O = 1.0 or 9.0 Vdc) (V _O = 1.5 or 13.5 Vdc)	“1” Level V _{IH}	5.0	3.5	–	3.5	2.75	–	3.5	–	Vdc
		10	7.0	–	7.0	5.50	–	7.0	–	
		15	11	–	11	8.25	–	11	–	
Output Drive Current (V _{OH} = 2.5 Vdc) (V _{OH} = 4.6 Vdc) (V _{OH} = 9.5 Vdc) (V _{OH} = 13.5 Vdc)	Source I _{OH}	5.0	–3.0	–	–2.4	–4.2	–	–1.7	–	mAdc
		5.0	–0.64	–	–0.51	–0.88	–	–0.36	–	
10		–1.6	–	–1.3	–2.25	–	–0.9	–		
15		–4.2	–	–3.4	–8.8	–	–2.4	–		
(V _{OL} = 0.4 Vdc) (V _{OL} = 0.5 Vdc) (V _{OL} = 1.5 Vdc)	Sink I _{OL}	5.0	0.64	–	0.51	0.88	–	0.36	–	mAdc
		10	1.6	–	1.3	2.25	–	0.9	–	
		15	4.2	–	3.4	8.8	–	2.4	–	
Input Current	I _{in}	15	–	±0.1	–	±0.00001	±0.1	–	±1.0	μAdc
Input Capacitance (V _{in} = 0)	C _{in}	–	–	–	–	5.0	7.5	–	–	pF
Quiescent Current (Per Package)	I _{DD}	5.0	–	5.0	–	0.005	5.0	–	150	μAdc
		10	–	10	–	0.010	10	–	300	
		15	–	20	–	0.015	20	–	600	
Total Supply Current (Notes 3 & 4) (Dynamic plus Quiescent, Per Package) (C _L = 50 pF on all outputs, all buffers switching)	I _T	5.0	I _T = (0.3 μA/kHz) f + I _{DD} I _T = (0.7 μA/kHz) f + I _{DD} I _T = (1.0 μA/kHz) f + I _{DD}							μAdc

Product parametric performance is indicated in the Electrical Characteristics for the listed test conditions, unless otherwise noted. Product performance may not be indicated by the Electrical Characteristics if operated under different conditions.

2. Data labelled “Typ” is not to be used for design purposes but is intended as an indication of the IC’s potential performance.

3. The formulas given are for the typical characteristics only at 25°C.

4. To calculate total supply current at loads other than 50 pF:

$$I_T(C_L) = I_T(50 \text{ pF}) + (C_L - 50) \text{ Vfk}$$

where: I_T is in μA (per package), C_L in pF, V = (V_{DD} – V_{SS}) in volts, f in kHz is input frequency, and k = 0.001.

ORDERING INFORMATION

Device	Package	Shipping [†]
MC14018BDG	SOIC–16 (Pb–Free)	48 Units / Rail
NLV14018BDG*	SOIC–16 (Pb–Free)	48 Units / Rail
MC14018BDR2G	SOIC–16 (Pb–Free)	2500 Units / Tape & Reel

[†]For information on tape and reel specifications, including part orientation and tape sizes, please refer to our Tape and Reel Packaging Specifications Brochure, BRD8011/D.

*NLV Prefix for Automotive and Other Applications Requiring Unique Site and Control Change Requirements; AEC–Q100 Qualified and PPAP Capable.

MC14018B

SWITCHING CHARACTERISTICS (Note 5) ($C_L = 50 \text{ pF}$, $T_A = 25^\circ\text{C}$)

Characteristic	Symbol	V_{DD} Vdc	All Types			Unit
			Min	Typ (Note 6)	Max	
Output Rise and Fall Time t_{TLH} , $t_{THL} = (1.35 \text{ ns/pF}) C_L + 32 \text{ ns}$ t_{TLH} , $t_{THL} = (0.6 \text{ ns/pF}) C_L + 20 \text{ ns}$ t_{TLH} , $t_{THL} = (0.4 \text{ ns/pF}) C_L + 20 \text{ ns}$	t_{TLH} , t_{THL}	5.0 10 15	– – –	100 50 40	200 100 80	ns
Propagation Delay Time Clock to \bar{Q} t_{PLH} , $t_{PHL} = (0.90 \text{ ns/pF}) C_L + 265 \text{ ns}$ t_{PLH} , $t_{PHL} = (0.36 \text{ ns/pF}) C_L + 102 \text{ ns}$ t_{PLH} , $t_{PHL} = (0.26 \text{ ns/pF}) C_L + 72 \text{ ns}$	t_{PLH} , t_{PHL}	5.0 10 15	– – –	310 120 85	620 240 170	ns
Reset to \bar{Q} $t_{PLH} = (0.90 \text{ ns/pF}) C_L + 325 \text{ ns}$ $t_{PLH} = (0.36 \text{ ns/pF}) C_L + 132 \text{ ns}$ $t_{PLH} = (0.26 \text{ ns/pF}) C_L + 81 \text{ ns}$		5.0 10 15	– – –	370 150 100	740 300 200	ns
Preset Enable to \bar{Q} t_{PLH} , $t_{PHL} = (0.90 \text{ ns/pF}) C_L + 325 \text{ ns}$ t_{PLH} , $t_{PHL} = (0.36 \text{ ns/pF}) C_L + 132 \text{ ns}$ t_{PLH} , $t_{PHL} = (0.26 \text{ ns/pF}) C_L + 81 \text{ ns}$		5.0 10 15	– – –	370 150 100	740 300 200	ns
Setup Time Data (Pin 1) to Clock	t_{su}	5.0 10 15	200 100 80	0 0 0	– – –	ns
Jam Inputs to Preset Enable		5.0 10 15	200 100 80	0 0 0	– – –	ns
Data (Jam Inputs)–to–Preset Enable Hold Time	t_h	5.0 10 15	540 500 480	270 250 240	– – –	ns
Clock Pulse Width	t_{WH}	5.0 10 15	400 200 160	200 100 80	– – –	ns
Reset or Preset Enable Pulse Width	t_{WH}	5.0 10 15	290 130 110	145 65 55	– – –	ns
Clock Rise and Fall Time	t_{TLH} , t_{THL}	5.0 10 15	No Limit			ns
Clock Pulse Frequency	f_{cl}	5.0 10 15	– – –	2.5 6.5 8.0	1.25 3.25 4.0	MHz

5. The formulas given are for the typical characteristics only at 25°C.

6. Data labelled "Typ" is not to be used for design purposes but is intended as an indication of the IC's potential performance.

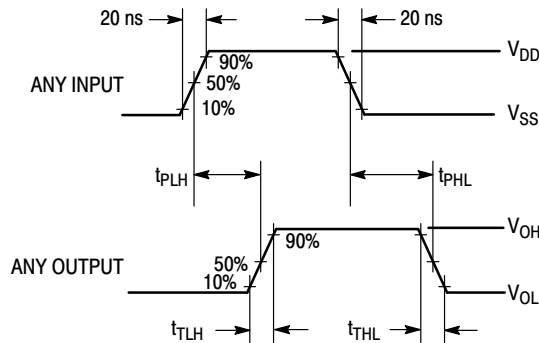
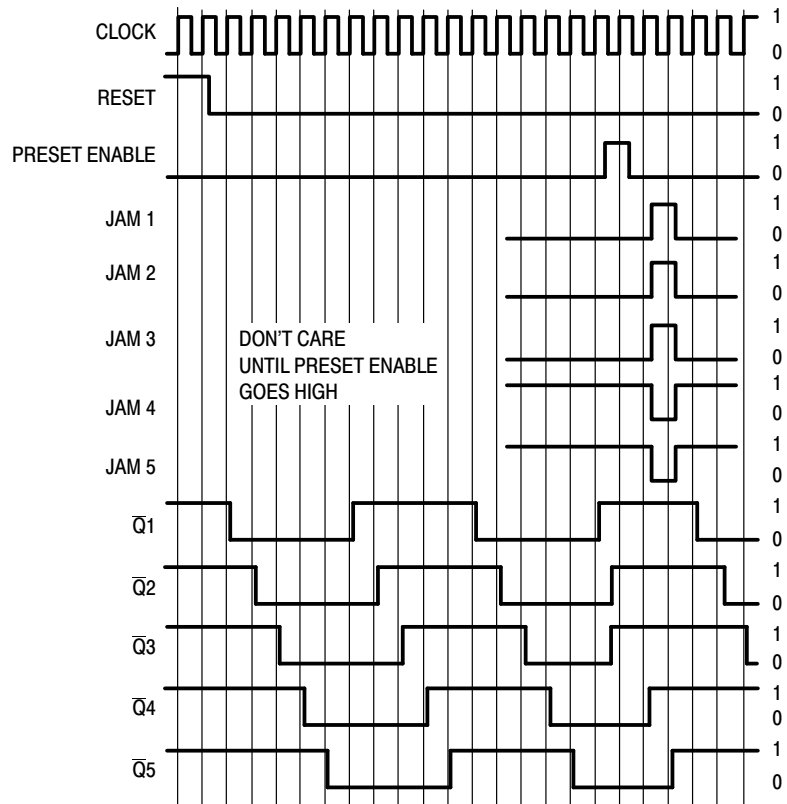

Figure 1. Switching Time Waveforms

MC14018B

TIMING DIAGRAM
($\bar{Q}5$ Connected to Data Input)



FUNCTION SELECTION

Counter Mode	Connect Data Input (Pin 1) to:	Comments
Divide by 10 Divide by 8 Divide by 6 Divide by 4 Divide by 2	$\bar{Q}5$ $\bar{Q}4$ $\bar{Q}3$ $\bar{Q}2$ $\bar{Q}1$	No external components needed.
Divide by 9 Divide by 7 Divide by 5 Divide by 3	$\bar{Q}5 \cdot \bar{Q}4$ $\bar{Q}4 \cdot \bar{Q}3$ $\bar{Q}3 \cdot \bar{Q}2$ $\bar{Q}2 \cdot \bar{Q}1$	Gate package needed to provide AND function. Counter Skips all 1's state

LOGIC DIAGRAM

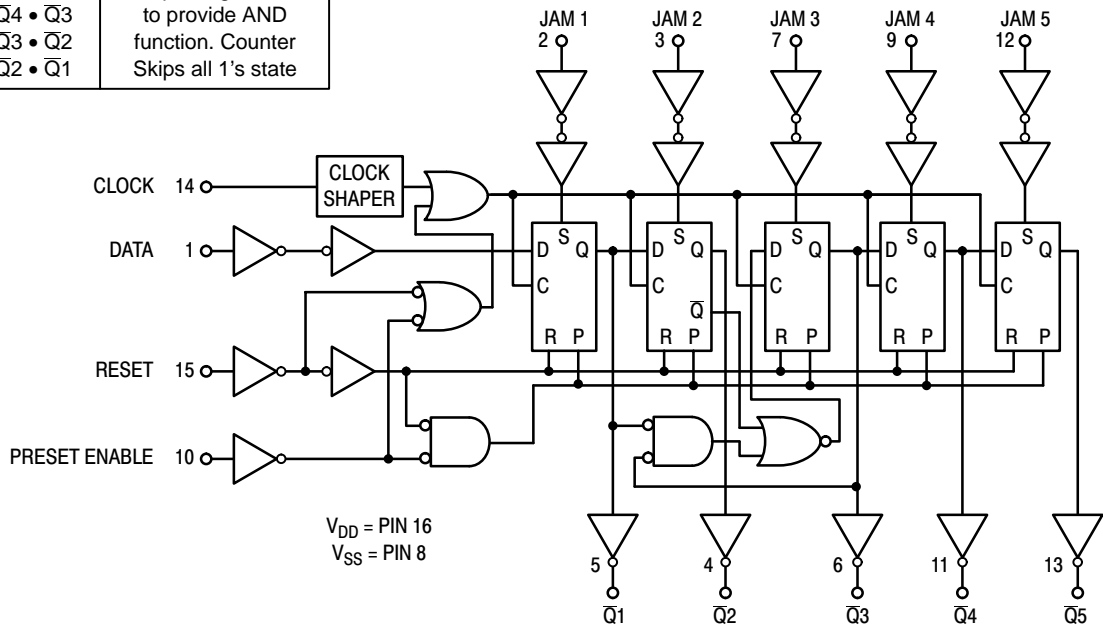

MECHANICAL CASE OUTLINE PACKAGE DIMENSIONS

ON Semiconductor®

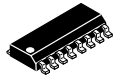

SCALE 1:1

SOIC-16 CASE 751B-05 ISSUE K

DATE 29 DEC 2006



NOTES:

1. DIMENSIONING AND TOLERANCING PER ANSI Y14.5M, 1982.
2. CONTROLLING DIMENSION: MILLIMETER.
3. DIMENSIONS A AND B DO NOT INCLUDE MOLD PROTRUSION.
4. MAXIMUM MOLD PROTRUSION 0.15 (0.006) PER SIDE.
5. DIMENSION D DOES NOT INCLUDE DAMBAR PROTRUSION. ALLOWABLE DAMBAR PROTRUSION SHALL BE 0.127 (0.005) TOTAL IN EXCESS OF THE D DIMENSION AT MAXIMUM MATERIAL CONDITION.

DIM	MILLIMETERS		INCHES	
	MIN	MAX	MIN	MAX
A	9.80	10.00	0.386	0.393
B	3.80	4.00	0.150	0.157
C	1.35	1.75	0.054	0.068
D	0.35	0.49	0.014	0.019
F	0.40	1.25	0.016	0.049
G	1.27 BSC		0.050 BSC	
J	0.19	0.25	0.008	0.009
K	0.10	0.25	0.004	0.009
M	0°	7°	0°	7°
P	5.80	6.20	0.229	0.244
R	0.25	0.50	0.010	0.019

- | | | | |
|--|--|--|--|
| <p>STYLE 1:</p> <p>PIN 1. COLLECTOR</p> <p>2. BASE</p> <p>3. EMITTER</p> <p>4. NO CONNECTION</p> <p>5. EMITTER</p> <p>6. BASE</p> <p>7. COLLECTOR</p> <p>8. COLLECTOR</p> <p>9. BASE</p> <p>10. EMITTER</p> <p>11. NO CONNECTION</p> <p>12. EMITTER</p> <p>13. BASE</p> <p>14. COLLECTOR</p> <p>15. EMITTER</p> <p>16. COLLECTOR</p> | <p>STYLE 2:</p> <p>PIN 1. CATHODE</p> <p>2. ANODE</p> <p>3. NO CONNECTION</p> <p>4. CATHODE</p> <p>5. CATHODE</p> <p>6. NO CONNECTION</p> <p>7. ANODE</p> <p>8. CATHODE</p> <p>9. CATHODE</p> <p>10. ANODE</p> <p>11. NO CONNECTION</p> <p>12. CATHODE</p> <p>13. CATHODE</p> <p>14. NO CONNECTION</p> <p>15. ANODE</p> <p>16. CATHODE</p> | <p>STYLE 3:</p> <p>PIN 1. COLLECTOR, DYE #1</p> <p>2. BASE, #1</p> <p>3. EMITTER, #1</p> <p>4. COLLECTOR, #1</p> <p>5. COLLECTOR, #2</p> <p>6. BASE, #2</p> <p>7. EMITTER, #2</p> <p>8. COLLECTOR, #2</p> <p>9. COLLECTOR, #3</p> <p>10. BASE, #3</p> <p>11. EMITTER, #3</p> <p>12. COLLECTOR, #3</p> <p>13. COLLECTOR, #4</p> <p>14. BASE, #4</p> <p>15. EMITTER, #4</p> <p>16. COLLECTOR, #4</p> | <p>STYLE 4:</p> <p>PIN 1. COLLECTOR, DYE #1</p> <p>2. COLLECTOR, #1</p> <p>3. COLLECTOR, #2</p> <p>4. COLLECTOR, #2</p> <p>5. COLLECTOR, #3</p> <p>6. COLLECTOR, #3</p> <p>7. COLLECTOR, #4</p> <p>8. COLLECTOR, #4</p> <p>9. BASE, #4</p> <p>10. EMITTER, #4</p> <p>11. BASE, #3</p> <p>12. EMITTER, #3</p> <p>13. BASE, #2</p> <p>14. EMITTER, #2</p> <p>15. BASE, #1</p> <p>16. EMITTER, #1</p> |
| <p>STYLE 5:</p> <p>PIN 1. DRAIN, DYE #1</p> <p>2. DRAIN, #1</p> <p>3. DRAIN, #2</p> <p>4. DRAIN, #2</p> <p>5. DRAIN, #3</p> <p>6. DRAIN, #3</p> <p>7. DRAIN, #4</p> <p>8. DRAIN, #4</p> <p>9. GATE, #4</p> <p>10. SOURCE, #4</p> <p>11. GATE, #3</p> <p>12. SOURCE, #3</p> <p>13. GATE, #2</p> <p>14. SOURCE, #2</p> <p>15. GATE, #1</p> <p>16. SOURCE, #1</p> | <p>STYLE 6:</p> <p>PIN 1. CATHODE</p> <p>2. CATHODE</p> <p>3. CATHODE</p> <p>4. CATHODE</p> <p>5. CATHODE</p> <p>6. CATHODE</p> <p>7. CATHODE</p> <p>8. CATHODE</p> <p>9. ANODE</p> <p>10. ANODE</p> <p>11. ANODE</p> <p>12. ANODE</p> <p>13. ANODE</p> <p>14. ANODE</p> <p>15. ANODE</p> <p>16. ANODE</p> | <p>STYLE 7:</p> <p>PIN 1. SOURCE N-CH</p> <p>2. COMMON DRAIN (OUTPUT)</p> <p>3. COMMON DRAIN (OUTPUT)</p> <p>4. GATE P-CH</p> <p>5. COMMON DRAIN (OUTPUT)</p> <p>6. COMMON DRAIN (OUTPUT)</p> <p>7. COMMON DRAIN (OUTPUT)</p> <p>8. SOURCE P-CH</p> <p>9. SOURCE P-CH</p> <p>10. COMMON DRAIN (OUTPUT)</p> <p>11. COMMON DRAIN (OUTPUT)</p> <p>12. COMMON DRAIN (OUTPUT)</p> <p>13. GATE N-CH</p> <p>14. COMMON DRAIN (OUTPUT)</p> <p>15. COMMON DRAIN (OUTPUT)</p> <p>16. SOURCE N-CH</p> | |

SOLDERING FOOTPRINT

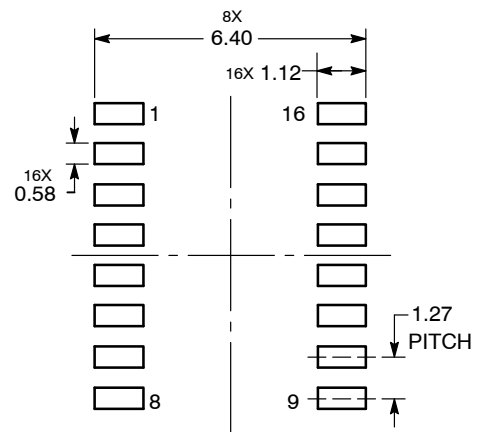

DOCUMENT NUMBER:	98ASB42566B	Electronic versions are uncontrolled except when accessed directly from the Document Repository. Printed versions are uncontrolled except when stamped "CONTROLLED COPY" in red.
DESCRIPTION:	SOIC-16	PAGE 1 OF 1

ON Semiconductor and are trademarks of Semiconductor Components Industries, LLC dba ON Semiconductor or its subsidiaries in the United States and/or other countries. ON Semiconductor reserves the right to make changes without further notice to any products herein. ON Semiconductor makes no warranty, representation or guarantee regarding the suitability of its products for any particular purpose, nor does ON Semiconductor assume any liability arising out of the application or use of any product or circuit, and specifically disclaims any and all liability, including without limitation special, consequential or incidental damages. ON Semiconductor does not convey any license under its patent rights nor the rights of others.

ON Semiconductor and  are trademarks of Semiconductor Components Industries, LLC dba ON Semiconductor or its subsidiaries in the United States and/or other countries. ON Semiconductor owns the rights to a number of patents, trademarks, copyrights, trade secrets, and other intellectual property. A listing of ON Semiconductor's product/patent coverage may be accessed at www.onsemi.com/site/pdf/Patent-Marking.pdf. ON Semiconductor reserves the right to make changes without further notice to any products herein. ON Semiconductor makes no warranty, representation or guarantee regarding the suitability of its products for any particular purpose, nor does ON Semiconductor assume any liability arising out of the application or use of any product or circuit, and specifically disclaims any and all liability, including without limitation special, consequential or incidental damages. Buyer is responsible for its products and applications using ON Semiconductor products, including compliance with all laws, regulations and safety requirements or standards, regardless of any support or applications information provided by ON Semiconductor. "Typical" parameters which may be provided in ON Semiconductor data sheets and/or specifications can and do vary in different applications and actual performance may vary over time. All operating parameters, including "Typicals" must be validated for each customer application by customer's technical experts. ON Semiconductor does not convey any license under its patent rights nor the rights of others. ON Semiconductor products are not designed, intended, or authorized for use as a critical component in life support systems or any FDA Class 3 medical devices or medical devices with a same or similar classification in a foreign jurisdiction or any devices intended for implantation in the human body. Should Buyer purchase or use ON Semiconductor products for any such unintended or unauthorized application, Buyer shall indemnify and hold ON Semiconductor and its officers, employees, subsidiaries, affiliates, and distributors harmless against all claims, costs, damages, and expenses, and reasonable attorney fees arising out of, directly or indirectly, any claim of personal injury or death associated with such unintended or unauthorized use, even if such claim alleges that ON Semiconductor was negligent regarding the design or manufacture of the part. ON Semiconductor is an Equal Opportunity/Affirmative Action Employer. This literature is subject to all applicable copyright laws and is not for resale in any manner.

PUBLICATION ORDERING INFORMATION

LITERATURE FULFILLMENT:

Email Requests to: orderlit@onsemi.com

ON Semiconductor Website: www.onsemi.com

TECHNICAL SUPPORT

North American Technical Support:
Voice Mail: 1 800-282-9855 Toll Free USA/Canada
Phone: 011 421 33 790 2910

Europe, Middle East and Africa Technical Support:

Phone: 00421 33 790 2910

For additional information, please contact your local Sales Representative