

NLX2G08

Dual 2-Input AND Gate

The NLX2G08 is an advanced high-speed dual 2-input CMOS AND gate in ultra-small footprint.

The NLX2G08 input structures provide protection when voltages up to 7.0 volts are applied, regardless of the supply voltage.

Features

- High Speed: t_{PD} 2.5 ns (typical) at $V_{CC} = 5.0$ V
- Designed for 1.65 V to 5.5 V V_{CC} Operation
- Low Power Dissipation: $I_{CC} = 1$ μ A (Max) at $T_A = 25^\circ$ C
- 24 mA Balanced Output Sink and Source Capability
- Balanced Propagation Delays
- Overvoltage Tolerant (OVT) Input Pins
- These Devices are Pb-Free, Halogen Free/BFR Free and are RoHS Compliant

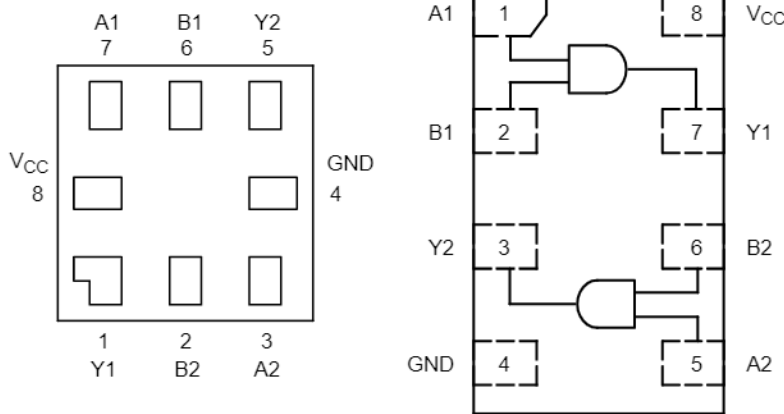

Figure 1. Pinouts

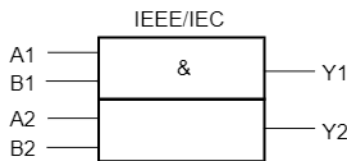

Figure 2. Logic Symbol

FUNCTION TABLE

$$Y = AB$$

Inputs		Output
A	B	Y
L	L	L
L	H	L
H	L	L
H	H	H

H = HIGH Logic Level
L = LOW Logic Level

PIN ASSIGNMENT

Pin	Function (UQFN8)	Function (ULLGA/UDFN)
1	Y1	A1
2	B2	B1
3	A2	Y2
4	GND	GND
5	Y2	A2
6	B1	B2
7	A1	Y1
8	V_{CC}	V_{CC}



ON Semiconductor®

www.onsemi.com

MARKING DIAGRAMS



UQFN8
MU SUFFIX
CASE 523AN

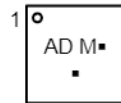

UDFN8
1.45 x 1.0
CASE 517BZ

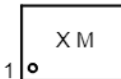

UDFN8
1.6 x 1.0
CASE 517BY

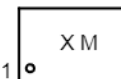

UDFN8
1.95 x 1.0
CASE 517CA

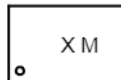

XX = Specific Device Code
M = Date Code
▪ = Pb-Free Package

(Note: Microdot may be in either location)

ORDERING INFORMATION

See detailed ordering and shipping information in the package dimensions section on page 4 of this data sheet.

NLX2G08

MAXIMUM RATINGS

Symbol	Parameter	Value	Unit
V_{CC}	DC Supply Voltage	-0.5 to +7.0	V
V_{IN}	DC Input Voltage	-0.5 to +7.0	V
V_{OUT}	DC Output Voltage	-0.5 to $V_{CC} + 0.5$	V
I_{IK}	DC Input Diode Current $V_{IN} < GND$	-50	mA
I_{OK}	DC Output Diode Current $V_{OUT} < GND$	-50	mA
I_O	DC Output Source/Sink Current	± 50	mA
I_{CC}	DC Supply Current per Supply Pin	± 100	mA
I_{GND}	DC Ground Current per Ground Pin	± 100	mA
T_{STG}	Storage Temperature Range	-65 to +150	°C
T_L	Lead Temperature, 1 mm from Case for 10 Seconds	260	°C
T_J	Junction Temperature Under Bias	+150	°C
θ_{JA}	Thermal Resistance (Note 1)	250	°C/W
P_D	Power Dissipation in Still Air at 85°C	250	mW
MSL	Moisture Sensitivity	Level 1	
F_R	Flammability Rating Oxygen Index: 28 to 34	UL 94 V-0 @ 0.125 in	
V_{ESD}	ESD Withstand Voltage Human Body Model (Note 2) Machine Model (Note 3) Charged Device Model (Note 4)	>2000 >200 N/A	V
$I_{Latchup}$	Latchup Performance Above V_{CC} and Below GND at 125°C (Note 5)	± 500	mA

Stresses exceeding those listed in the Maximum Ratings table may damage the device. If any of these limits are exceeded, device functionality should not be assumed, damage may occur and reliability may be affected.

1. Measured with minimum pad spacing on an FR4 board, using 10 mm-by-1 inch, 2-ounce copper trace with no air flow.
2. Tested to EIA/JESD22-A114-A.
3. Tested to EIA/JESD22-A115-A.
4. Tested to JESD22-C101-A.
5. Tested to EIA/JESD78.

RECOMMENDED OPERATING CONDITIONS

Symbol	Parameter	Min	Max	Unit
V_{CC}	Power DC Supply Voltage Operating Data Retention Only	1.65 1.5	5.5 5.5	V
V_{IN}	Digital Input Voltage (Note 6)	0	5.5	V
V_{OUT}	Output Voltage	0	V_{CC}	V
T_A	Operating Free-Air Temperature	-55	+125	°C
$\Delta t/\Delta V$	Input Transition Rise or Fall Rate $V_{CC} = 1.8 V \pm 0.15 V$ $V_{CC} = 2.5 V \pm 0.2 V$ $V_{CC} = 3.3 V \pm 0.3 V$ $V_{CC} = 5.0 V \pm 0.5 V$	0 0 0 0	20 20 10 5	ns/V

Functional operation above the stresses listed in the Recommended Operating Ranges is not implied. Extended exposure to stresses beyond the Recommended Operating Ranges limits may affect device reliability.

6. Unused inputs may not be left open. All inputs must be tied to a high- or low-logic input voltage level.

NLX2G08

DC ELECTRICAL CHARACTERISTICS

Symbol	Parameter	Condition	V _{CC} (V)	T _A = 25°C			T _A ≤ 85°C		T _A = -55°C to +125°C		Unit
				Min	Typ	Max	Min	Max	Min	Max	
V _{IH}	High-Level Input Voltage		1.65 2.3 to 5.5	0.75 x V _{CC} 0.7 x V _{CC}			0.75 x V _{CC} 0.7 x V _{CC}		0.75 x V _{CC} 0.7 x V _{CC}		V
V _{IL}	Low-Level Input Voltage		1.65 2.3 to 5.5			0.25 x V _{CC} 0.3 x V _{CC}		0.25 x V _{CC} 0.3 x V _{CC}		0.25 x V _{CC} 0.3 x V _{CC}	V
V _{OH}	High-Level Output Voltage	V _{IN} = V _{IH} or V _{IL} , I _{OH} = -100 μA	1.65 to 5.5	V _{CC} - 0.1	V _{CC}		V _{CC} - 0.1		V _{CC} - 0.1		V
		V _{IN} = V _{IH} or V _{IL} I _{OH} = -4 mA	1.65	1.29	1.5		1.29		1.29		
		I _{OH} = -8 mA	2.3	1.9	2.1		1.9		1.9		
		I _{OH} = -12 mA	2.7	2.2	2.4		2.2		2.2		
		I _{OH} = -16 mA	3.0	2.4	2.7		2.4		2.4		
		I _{OH} = -24 mA	3.0	2.3	2.5		2.3		2.3		
I _{OH} = -32 mA	4.5	3.8	4.0		3.8		3.8				
V _{OL}	Low-Level Output Voltage	V _{IN} = V _{IH} or V _{IL} , I _{OL} = 100 μA	1.65 to 5.5			0.1		0.1		0.1	V
		V _{IN} = V _{IH} or V _{IL} I _{OL} = 4 mA	1.65		0.08	0.24		0.24		0.24	
		I _{OL} = 8 mA	2.3		0.20	0.3		0.3		0.3	
		I _{OL} = 12 mA	2.7		0.22	0.4		0.4		0.4	
		I _{OL} = 16 mA	3.0		0.28	0.4		0.4		0.4	
		I _{OL} = 24 mA	3.0		0.38	0.55		0.55		0.55	
I _{OL} = 32 mA	4.5		0.42	0.55		0.55		0.55			
I _{IN}	Input Leakage Current	0 ≤ V _{IN} ≤ 5.5 V	0 to 5.5			±0.1		±1.0		±1.0	μA
I _{OFF}	Power-Off Input Leakage Current	V _{IN} = 5.5 V	0			1.0		10		10	μA
I _{CC}	Quiescent Supply Current	0 ≤ V _{IN} ≤ 5.5 V	5.5			1.0		10		10	μA

Product parametric performance is indicated in the Electrical Characteristics for the listed test conditions, unless otherwise noted. Product performance may not be indicated by the Electrical Characteristics if operated under different conditions.

AC ELECTRICAL CHARACTERISTICS t_R = t_F = 2.5 ns

Symbol	Parameter	V _{CC} (V)	Test Condition	T _A = 25°C			T _A ≤ 85°C		T _A = -55°C to +125°C		Unit
				Min	Typ	Max	Min	Max	Min	Max	
t _{PLH} t _{PHL}	Propagation Delay Input A to Output	1.65 to 1.95	R _L = 1 MΩ, C _L = 15 pF	2.0	5.7	10.5	2.0	11.0	2.0	11.2	ns
		2.3 to 2.7	R _L = 1 MΩ, C _L = 15 pF	1.2	3.5	5.8	1.2	6.2	1.2	6.3	
		3.0 to 3.6	R _L = 1 MΩ, C _L = 15 pF	0.8	2.6	3.9	0.8	4.3	0.8	4.7	
			R _L = 500 Ω, C _L = 50 pF		3.2	4.8		5.2		5.3	
4.5 to 5.5	R _L = 1 MΩ, C _L = 15 pF		1.9	3.1		3.3	0.5	4.0			
	R _L = 500 Ω, C _L = 50 pF		2.5	3.7		4.0		4.3			
C _{IN}	Input Capacitance	5.5	V _{IN} = 0 V or V _{CC}		2.5					pF	
C _{PD}	Power Dissipation Capacitance (Note 7)	3.3 5.5	10 MHz, V _{IN} = 0V or V _{CC}		9 11					pF	

7. C_{PD} is defined as the value of the internal equivalent capacitance which is calculated from the operating current consumption without load. Average operating current can be obtained by the equation: I_{CC(OPR)} = C_{PD} • V_{CC} • f_{in} + I_{CC}. C_{PD} is used to determine the no-load dynamic power consumption; P_D = C_{PD} • V_{CC}² • f_{in} + I_{CC} • V_{CC}.

NLX2G08

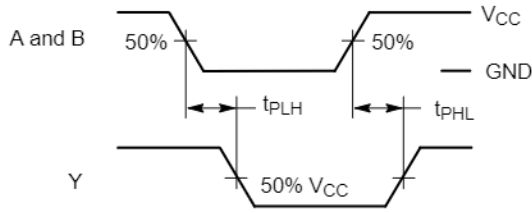

PROPAGATION DELAYS

$t_R = t_F = 2.5 \text{ ns}$, 10% to 90%; $f = 1 \text{ MHz}$; $t_W = 500 \text{ ns}$

Figure 3. Switching Waveform

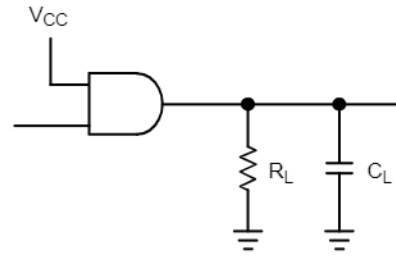

A 1-MHz square input wave is recommended for propagation delay tests.

Figure 4. Test Circuit

ORDERING INFORMATION

Device	Package	Shipping†
NLX2G08MUTCG	UQFN8 (Pb-Free)	3000 / Tape & Reel
NLX2G08DMUTCG*	UDFN8, 1.95 x 1.0, 0.5P (Pb-Free)	3000 / Tape & Reel
NLX2G08DMUTWG*	UDFN8, 1.95 x 1.0, 0.5P (Pb-Free)	3000 / Tape & Reel

†For information on tape and reel specifications, including part orientation and tape sizes, please refer to our Tape and Reel Packaging Specifications Brochure, BRD8011/D.

*These device differ only in tape and reel pin 1 orientation.

NLX2G08

PACKAGE DIMENSIONS

UDFN8 1.6x1.0, 0.4P
CASE 517BY
ISSUE O

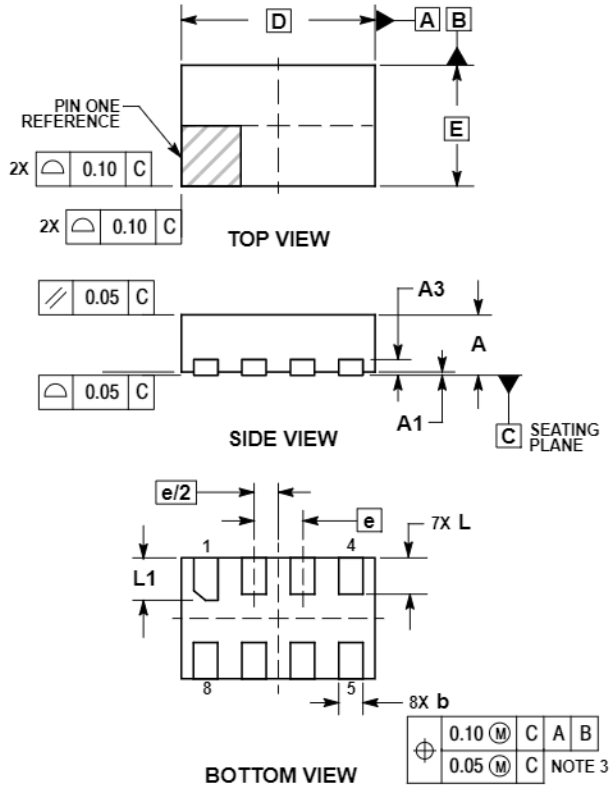

NOTES:

1. DIMENSIONING AND TOLERANCING PER ASME Y14.5M, 1994.
2. CONTROLLING DIMENSION: MILLIMETERS.
3. DIMENSION b APPLIES TO PLATED TERMINAL AND IS MEASURED BETWEEN 0.15 AND 0.20 MM FROM TERMINAL TIP.
4. PACKAGE DIMENSIONS EXCLUSIVE OF BURRS AND MOLD FLASH.

MILLIMETERS		
DIM	MIN	MAX
A	0.45	0.55
A1	0.00	0.05
A3	0.13	REF
b	0.15	0.25
D	1.60	BSC
E	1.00	BSC
e	0.40	BSC
L	0.25	0.35
L1	0.30	0.40

RECOMMENDED SOLDERING FOOTPRINT*

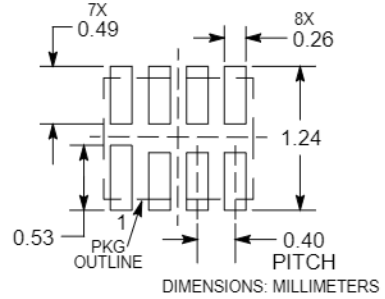

*For additional information on our Pb-Free strategy and soldering details, please download the ON Semiconductor Soldering and Mounting Techniques Reference Manual, SOLDERRM/D.

NLX2G08

PACKAGE DIMENSIONS

UDFN8 1.45x1.0, 0.35P
CASE 517BZ
ISSUE O

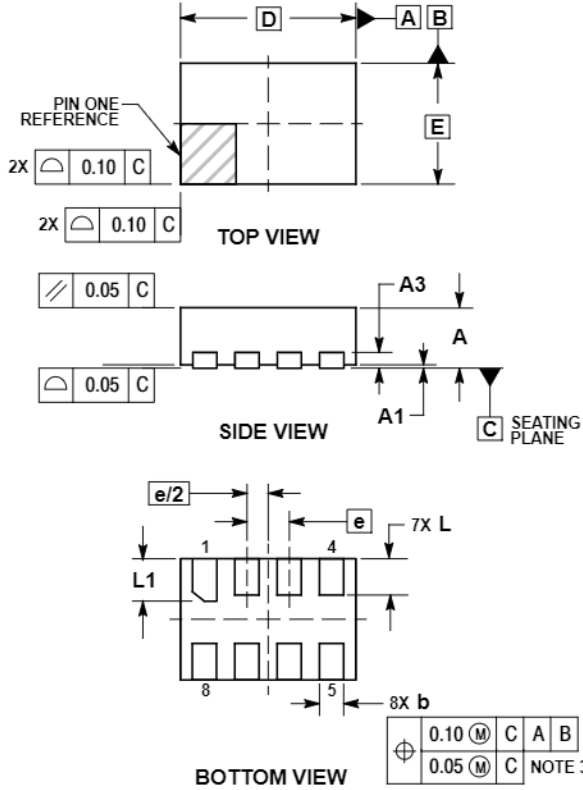

NOTES:

1. DIMENSIONING AND TOLERANCING PER ASME Y14.5M, 1994.
2. CONTROLLING DIMENSION: MILLIMETERS.
3. DIMENSION b APPLIES TO PLATED TERMINAL AND IS MEASURED BETWEEN 0.15 AND 0.20 MM FROM TERMINAL TIP
4. PACKAGE DIMENSIONS EXCLUSIVE OF BURRS AND MOLD FLASH.

DIM	MILLIMETERS	
	MIN	MAX
A	0.45	0.55
A1	0.00	0.05
A3	0.13	REF
b	0.15	0.25
D	1.45	BSC
E	1.00	BSC
e	0.35	BSC
L	0.25	0.35
L1	0.30	0.40

RECOMMENDED SOLDERING FOOTPRINT*

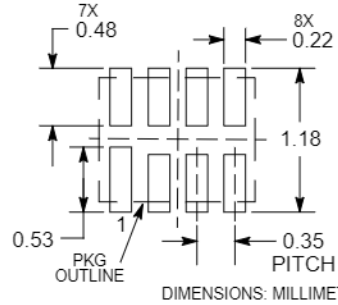

*For additional information on our Pb-Free strategy and soldering details, please download the ON Semiconductor Soldering and Mounting Techniques Reference Manual, SOLDERRM/D.

NLX2G08

PACKAGE DIMENSIONS

UDFN8 1.95x1.0, 0.5P
CASE 517CA
ISSUE O

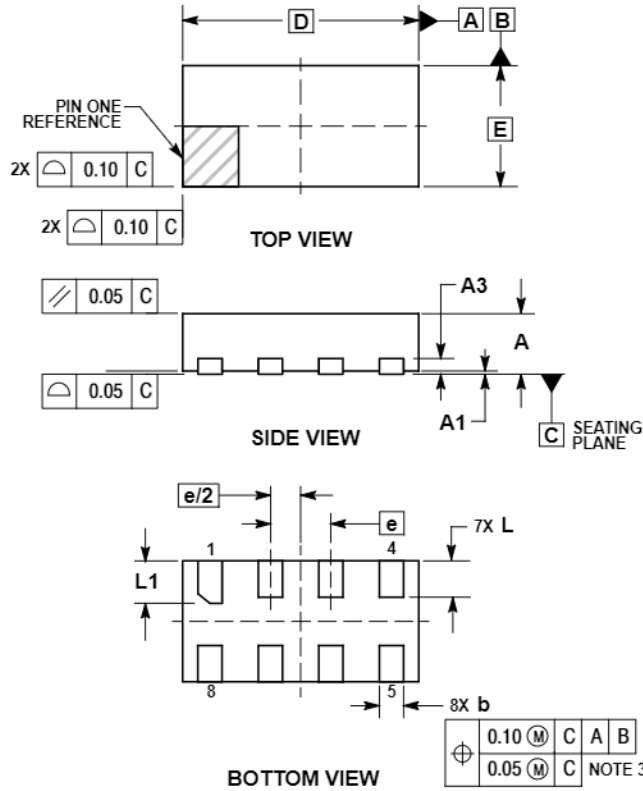

NOTES:

1. DIMENSIONING AND TOLERANCING PER ASME Y14.5M, 1994.
2. CONTROLLING DIMENSION: MILLIMETERS.
3. DIMENSION b APPLIES TO PLATED TERMINAL AND IS MEASURED BETWEEN 0.15 AND 0.20 MM FROM TERMINAL TIP.
4. PACKAGE DIMENSIONS EXCLUSIVE OF BURRS AND MOLD FLASH.

MILLIMETERS		
DIM	MIN	MAX
A	0.45	0.55
A1	0.00	0.05
A3	0.13	REF
b	0.15	0.25
D	1.95	BSC
E	1.00	BSC
e	0.50	BSC
L	0.25	0.35
L1	0.30	0.40

RECOMMENDED SOLDERING FOOTPRINT*

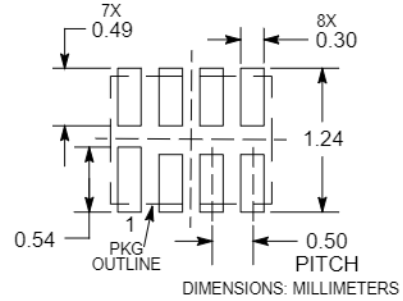

*For additional information on our Pb-Free strategy and soldering details, please download the ON Semiconductor Soldering and Mounting Techniques Reference Manual, SOLDERRM/D.

NLX2G08

PACKAGE DIMENSIONS

UQFN8 MU SUFFIX CASE 523AN ISSUE O

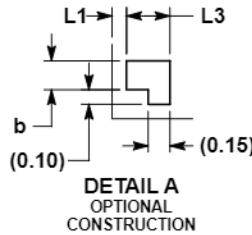
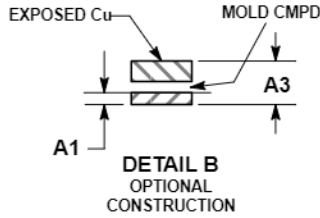
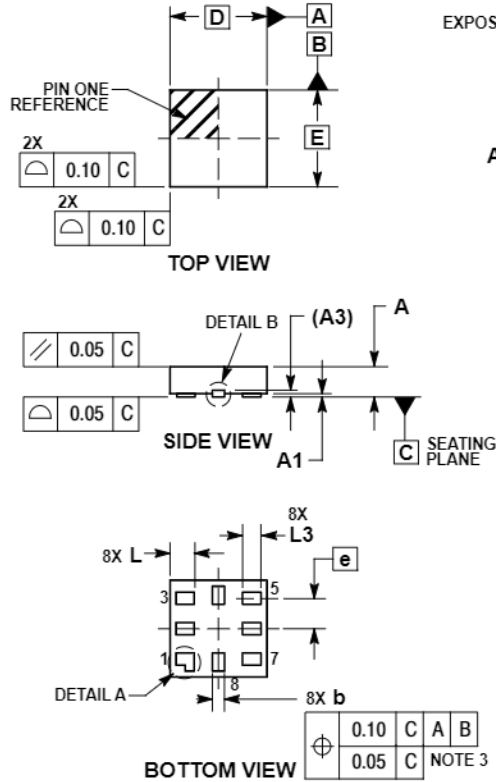

NOTES:

1. DIMENSIONING AND TOLERANCING PER ASME Y14.5M, 1994
2. CONTROLLING DIMENSION: MILLIMETERS.
3. DIMENSION b APPLIES TO PLATED TERMINAL AND IS MEASURED BETWEEN 0.15 AND 0.30 mm FROM THE TERMINAL TIP.

DIM	MILLIMETERS	
	MIN	MAX
A	0.45	0.60
A1	0.00	0.05
A3	0.13	REF
b	0.15	0.25
D	1.60	BSC
E	1.60	BSC
e	0.50	BSC
L	0.35	0.45
L1	---	0.15
L3	0.25	0.35

SOLDERING FOOTPRINT*

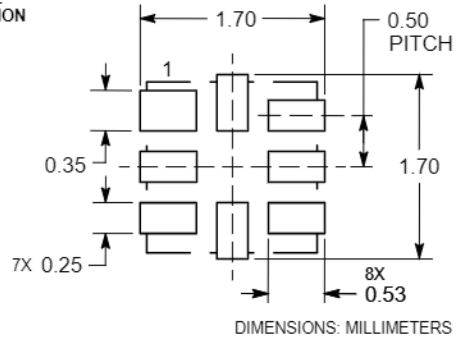

*For additional information on our Pb-Free strategy and soldering details, please download the ON Semiconductor Soldering and Mounting Techniques Reference Manual, SOLDERRM/D.

ON Semiconductor and are trademarks of Semiconductor Components Industries, LLC dba ON Semiconductor or its subsidiaries in the United States and/or other countries. ON Semiconductor owns the rights to a number of patents, trademarks, copyrights, trade secrets, and other intellectual property. A listing of ON Semiconductor's product/patent coverage may be accessed at www.onsemi.com/site/pdf/Patent-Marking.pdf. ON Semiconductor reserves the right to make changes without further notice to any products herein. ON Semiconductor makes no warranty, representation or guarantee regarding the suitability of its products for any particular purpose, nor does ON Semiconductor assume any liability arising out of the application or use of any product or circuit, and specifically disclaims any and all liability, including without limitation special, consequential or incidental damages. Buyer is responsible for its products and applications using ON Semiconductor products, including compliance with all laws, regulations and safety requirements or standards, regardless of any support or applications information provided by ON Semiconductor. "Typical" parameters which may be provided in ON Semiconductor data sheets and/or specifications can and do vary in different applications and actual performance may vary over time. All operating parameters, including "Typicals" must be validated for each customer application by customer's technical experts. ON Semiconductor does not convey any license under its patent rights nor the rights of others. ON Semiconductor products are not designed, intended, or authorized for use as a critical component in life support systems or any FDA Class 3 medical devices or medical devices with a same or similar classification in a foreign jurisdiction or any devices intended for implantation in the human body. Should Buyer purchase or use ON Semiconductor products for any such unintended or unauthorized application, Buyer shall indemnify and hold ON Semiconductor and its officers, employees, subsidiaries, affiliates, and distributors harmless against all claims, costs, damages, and expenses, and reasonable attorney fees arising out of, directly or indirectly, any claim of personal injury or death associated with such unintended or unauthorized use, even if such claim alleges that ON Semiconductor was negligent regarding the design or manufacture of the part. ON Semiconductor is an Equal Opportunity/Affirmative Action Employer. This literature is subject to all applicable copyright laws and is not for resale in any manner.

PUBLICATION ORDERING INFORMATION

LITERATURE FULFILLMENT:
Literature Distribution Center for ON Semiconductor
19521 E. 32nd Pkwy, Aurora, Colorado 80011 USA
Phone: 303-675-2175 or 800-344-3860 Toll Free USA/Canada
Fax: 303-675-2176 or 800-344-3867 Toll Free USA/Canada
Email: orderlit@onsemi.com

N. American Technical Support: 800-282-9855 Toll Free
USA/Canada
Europe, Middle East and Africa Technical Support:
Phone: 421 33 790 2910

ON Semiconductor Website: www.onsemi.com
Order Literature: <http://www.onsemi.com/orderlit>

For additional information, please contact your local Sales Representative