

MC74HC4060A

14-Stage Binary Ripple Counter With Oscillator

High-Performance Silicon-Gate CMOS

The MC74HC4060A is identical in pinout to the standard CMOS MC14060B. The device inputs are compatible with standard CMOS outputs; with pullup resistors, they are compatible with LSTTL outputs.

This device consists of 14 master-slave flip-flops and an oscillator with a frequency that is controlled either by a crystal or by an RC circuit connected externally. The output of each flip-flop feeds the next and the frequency at each output is half of that of the preceding one. The state of the counter advances on the negative-going edge of the Osc In. The active-high Reset is asynchronous and disables the oscillator to allow very low power consumption during stand-by operation.

State changes of the Q outputs do not occur simultaneously because of internal ripple delays. Therefore, decoded output signals are subject to decoding spikes and may have to be gated with Osc Out 2 of the HC4060A.

Features

- Output Drive Capability: 10 LSTTL Loads
- Outputs Directly Interface to CMOS, NMOS, and TTL
- Operating Voltage Range: 2.0 to 6.0 V
- Low Input Current: 1 μ A
- High Noise Immunity Characteristic of CMOS Devices
- In Compliance With JEDEC Standard No. 7A Requirements
- Chip Complexity: 390 FETs or 97.5 Equivalent Gates
- NLV Prefix for Automotive and Other Applications Requiring Unique Site and Control Change Requirements; AEC-Q100 Qualified and PPAP Capable
- These Devices are Pb-Free, Halogen Free/BFR Free and are RoHS Compliant

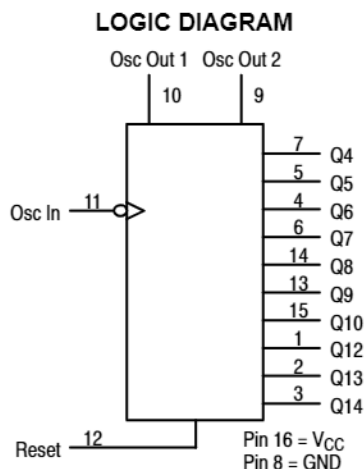

ON Semiconductor®

www.onsemi.com



SOIC-16
D SUFFIX
CASE 751B



TSSOP-16
DT SUFFIX
CASE 948F

PIN ASSIGNMENT

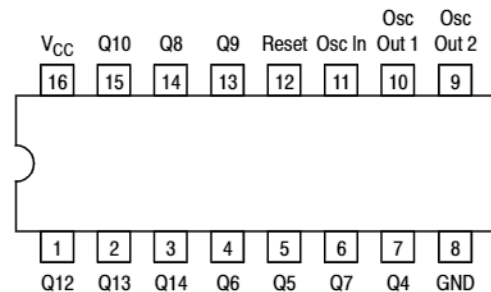

16-Lead Package (Top View)

MARKING DIAGRAMS

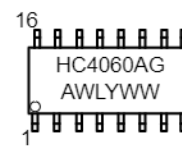

SOIC-16

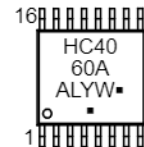

TSSOP-16

- A = Assembly Location
- L, WL = Wafer Lot
- Y, YY = Year
- W, WW = Work Week
- G or ■ = Pb-Free Package

(Note: Microdot may be in either location)

FUNCTION TABLE

Clock	Reset	Output State
	L	No Change
	L	Advance to Next State
X	H	All Outputs Are Low

ORDERING INFORMATION

See detailed ordering and shipping information in the package dimensions section on page 4 of this data sheet.

MC74HC4060A

MAXIMUM RATINGS

Symbol	Parameter	Value	Unit
V _{CC}	DC Supply Voltage (Referenced to GND)	-0.5 to +7.0	V
V _{in}	DC Input Voltage (Referenced to GND)	-0.5 to V _{CC} + 0.5	V
V _{out}	DC Output Voltage (Referenced to GND)	-0.5 to V _{CC} + 0.5	V
I _{in}	DC Input Current, per Pin	±20	mA
I _{out}	DC Output Current, per Pin	±25	mA
I _{CC}	DC Supply Current, V _{CC} and GND Pins	±50	mA
P _D	Power Dissipation in Still Air, SOIC Package† TSSOP Package†	500 450	mW
T _{stg}	Storage Temperature Range	-65 to +150	°C
T _L	Lead Temperature, 1 mm from Case for 10 Seconds SOIC or TSSOP Package	260	°C

This device contains protection circuitry to guard against damage due to high static voltages or electric fields. However, precautions must be taken to avoid applications of any voltage higher than maximum rated voltages to this high-impedance circuit. For proper operation, V_{in} and V_{out} should be constrained to the range GND ≤ (V_{in} or V_{out}) ≤ V_{CC}. Unused inputs must always be tied to an appropriate logic voltage level (e.g., either GND or V_{CC}). Unused outputs must be left open.

Stresses exceeding those listed in the Maximum Ratings table may damage the device. If any of these limits are exceeded, device functionality should not be assumed, damage may occur and reliability may be affected.

†Derating: SOIC Package: -7 mW/°C from 65° to 125°C
TSSOP Package: -6.1 mW/°C from 65° to 125°C

RECOMMENDED OPERATING CONDITIONS

Symbol	Parameter	Min	Max	Unit
V _{CC}	DC Supply Voltage (Referenced to GND)	2.5*	6.0	V
V _{in} , V _{out}	DC Input Voltage, Output Voltage (Referenced to GND)	0	V _{CC}	V
T _A	Operating Temperature Range, All Package Types	-55	+125	°C
t _r , t _f	Input Rise/Fall Time (Figure 1)	V _{CC} = 2.0 V V _{CC} = 4.5 V V _{CC} = 6.0 V	0 1000 500 400	ns

Functional operation above the stresses listed in the Recommended Operating Ranges is not implied. Extended exposure to stresses beyond the Recommended Operating Ranges limits may affect device reliability.

*The oscillator is guaranteed to function at 2.5 V minimum. However, parametrics are tested at 2.0 V by driving Pin 11 with an external clock source.

DC CHARACTERISTICS (Voltages Referenced to GND)

Symbol	Parameter	Condition	V _{CC} V	Guaranteed Limit			Unit
				-55 to 25°C	≤85°C	≤125°C	
V _{IH}	Minimum High-Level Input Voltage	V _{out} = 0.1V or V _{CC} - 0.1V I _{out} ≤ 20μA	2.0	1.50	1.50	1.50	V
			3.0	2.10	2.10	2.10	
			4.5	3.15	3.15	3.15	
			6.0	4.20	4.20	4.20	
V _{IL}	Maximum Low-Level Input Voltage	V _{out} = 0.1V or V _{CC} - 0.1V I _{out} ≤ 20μA	2.0	0.50	0.50	0.50	V
			3.0	0.90	0.90	0.90	
			4.5	1.35	1.35	1.35	
			6.0	1.80	1.80	1.80	
V _{OH}	Minimum High-Level Output Voltage (Q4-Q10, Q12-Q14)	V _{in} = V _{IH} or V _{IL} I _{out} ≤ 20μA	2.0	1.9	1.9	1.9	V
			4.5	4.4	4.4	4.4	
			6.0	5.9	5.9	5.9	
		V _{in} = V _{IH} or V _{IL} I _{out} ≤ 2.4mA I _{out} ≤ 4.0mA I _{out} ≤ 5.2mA	3.0	2.48	2.34	2.20	
			4.5	3.98	3.84	3.70	
			6.0	5.48	5.34	5.20	
V _{OL}	Maximum Low-Level Output Voltage (Q4-Q10, Q12-Q14)	V _{in} = V _{IH} or V _{IL} I _{out} ≤ 20μA	2.0	0.1	0.1	0.1	V
			4.5	0.1	0.1	0.1	
			6.0	0.1	0.1	0.1	
		V _{in} = V _{IH} or V _{IL} I _{out} ≤ 2.4mA I _{out} ≤ 4.0mA I _{out} ≤ 5.2mA	3.0	0.26	0.33	0.40	
			4.5	0.26	0.33	0.40	
			6.0	0.26	0.33	0.40	

MC74HC4060A

DC CHARACTERISTICS (Voltages Referenced to GND) (continued)

Symbol	Parameter	Condition	V _{CC} V	Guaranteed Limit			Unit
				-55 to 25°C	≤85°C	≤125°C	
V _{OH}	Minimum High-Level Output Voltage (Osc Out 1, Osc Out 2)	V _{in} = V _{CC} or GND I _{out} ≤ 20μA	2.0	1.9	1.9	1.9	V
			4.5	4.4	4.4	4.4	
			6.0	5.9	5.9	5.9	
		V _{in} = V _{CC} or GND I _{out} ≤ 0.7mA I _{out} ≤ 1.0mA I _{out} ≤ 1.3mA	3.0	2.48	2.34	2.20	
			4.5	3.98	3.84	3.70	
			6.0	5.48	5.34	5.20	
V _{OL}	Maximum Low-Level Output Voltage (Osc Out 1, Osc Out 2)	V _{in} = V _{CC} or GND I _{out} ≤ 20μA	2.0	0.1	0.1	0.1	V
			4.5	0.1	0.1	0.1	
			6.0	0.1	0.1	0.1	
		V _{in} = V _{CC} or GND I _{out} ≤ 0.7mA I _{out} ≤ 1.0mA I _{out} ≤ 1.3mA	3.0	0.26	0.33	0.40	
			4.5	0.26	0.33	0.40	
			6.0	0.26	0.33	0.40	
I _{in}	Maximum Input Leakage Current	V _{in} = V _{CC} or GND	6.0	±0.1	±1.0	±1.0	μA
I _{CC}	Maximum Quiescent Supply Current (per Package)	V _{in} = V _{CC} or GND I _{out} = 0μA	6.0	4	40	160	μA

AC CHARACTERISTICS (C_L = 50 pF, Input t_r = t_f = 6 ns)

Symbol	Parameter	V _{CC} V	Guaranteed Limit			Unit
			-55 to 25°C	≤85°C	≤125°C	
f _{max}	Maximum Clock Frequency (50% Duty Cycle) (Figures 1 and 4)	2.0	6.0	9.0	8.0	MHz
		3.0	10	14	12	
		4.5	30	28	25	
		6.0	50	45	40	
		6.0	50	45	40	
t _{PLH} , t _{PHL}	Maximum Propagation Delay, Osc In to Q4* (Figures 1 and 4)	2.0	300	375	450	ns
		3.0	180	200	250	
		4.5	60	75	90	
		6.0	51	64	75	
		6.0	51	64	75	
t _{PLH} , t _{PHL}	Maximum Propagation Delay, Osc In to Q14* (Figures 1 and 4)	2.0	500	750	1000	ns
		3.0	350	450	600	
		4.5	250	275	300	
		6.0	200	220	250	
		6.0	200	220	250	
t _{PHL}	Maximum Propagation Delay, Reset to Any Q (Figures 2 and 4)	2.0	195	245	300	ns
		3.0	75	100	125	
		4.5	39	49	61	
		6.0	33	42	53	
		6.0	33	42	53	
t _{PLH} , t _{PHL}	Maximum Propagation Delay, Q _n to Q _{n+1} (Figures 3 and 4)	2.0	75	95	125	ns
		3.0	60	75	95	
		4.5	15	19	24	
		6.0	13	16	20	
		6.0	13	16	20	

AC CHARACTERISTICS (C_L = 50 pF, Input t_r = t_f = 6 ns) - continued

Symbol	Parameter	V _{CC} V	Guaranteed Limit			Unit
			-55 to 25°C	≤85°C	≤125°C	
t _{TLH} , t _{THL}	Maximum Output Transition Time, Any Output (Figures 1 and 4)	2.0	75	95	110	ns
		3.0	27	32	36	
		4.5	15	19	22	
		6.0	13	16	19	
		6.0	13	16	19	
C _{in}	Maximum Input Capacitance		10	10	10	pF

* For T_A = 25°C and C_L = 50 pF, typical propagation delay from Clock to other Q outputs may be calculated with the following equations:

$$V_{CC} = 2.0 \text{ V: } t_p = [93.7 + 59.3(n-1)] \text{ ns}$$

$$V_{CC} = 4.5 \text{ V: } t_p = [30.25 + 14.6(n-1)] \text{ ns}$$

$$V_{CC} = 3.0 \text{ V: } t_p = [61.5 + 34.4(n-1)] \text{ ns}$$

$$V_{CC} = 6.0 \text{ V: } t_p = [24.4 + 12(n-1)] \text{ ns}$$

C _{PD}	Power Dissipation Capacitance (Per Package)*	Typical @ 25°C, V _{CC} = 5.0 V		pF
		35		

* Used to determine the no-load dynamic power consumption: P_D = C_{PD} V_{CC}²f + I_{CC} V_{CC}.

MC74HC4060A

TIMING REQUIREMENTS (Input $t_r = t_f = 6$ ns)

Symbol	Parameter	V _{CC} V	Guaranteed Limit			Unit
			-55 to 25°C	≤85°C	≤125°C	
t _{rec}	Minimum Recovery Time, Reset Inactive to Clock (Figure 2)	2.0	100	125	150	ns
		3.0	75	100	120	
		4.5	20	25	30	
		6.0	17	21	25	
t _w	Minimum Pulse Width, Clock (Figure 1)	2.0	75	95	110	ns
		3.0	27	32	36	
		4.5	15	19	23	
		6.0	13	16	19	
t _w	Minimum Pulse Width, Reset (Figure 2)	2.0	75	95	110	ns
		3.0	27	32	36	
		4.5	15	19	23	
		6.0	13	16	19	
t _r , t _f	Maximum Input Rise and Fall Times (Figure 1)	2.0	1000	1000	1000	ns
		3.0	800	800	800	
		4.5	500	500	500	
		6.0	400	400	400	

ORDERING INFORMATION

Device	Package	Shipping [†]
MC74HC4060ADG	SOIC-16 (Pb-Free)	48 Units / Rail
MC74HC4060ADR2G	SOIC-16 (Pb-Free)	2500 Units / Reel
NLV74HC4060ADR2G*	SOIC-16 (Pb-Free)	2500 Units / Reel
MC74HC4060ADTG	TSSOP-16 (Pb-Free)	96 Units / Rail
MC74HC4060ADTR2G	TSSOP-16 (Pb-Free)	2500 Units / Reel
NLVHC4060ADTR2G*	TSSOP-16 (Pb-Free)	2500 Units / Reel

[†]For information on tape and reel specifications, including part orientation and tape sizes, please refer to our Tape and Reel Packaging Specifications Brochure, BRD8011/D.

*NLV Prefix for Automotive and Other Applications Requiring Unique Site and Control Change Requirements; AEC-Q100 Qualified and PPAP Capable.

MC74HC4060A

PIN DESCRIPTIONS

INPUTS

Osc In (Pin 11)

Negative-edge triggering clock input. A high-to-low transition on this input advances the state of the counter. Osc In may be driven by an external clock source.

Reset (Pin 12)

Active-high reset. A high level applied to this input asynchronously resets the counter to its zero state (forcing all Q outputs low) and disables the oscillator.

OUTPUTS

Q4—Q10, Q12—Q14 (Pins 7, 5, 4, 6, 13, 15, 1, 2, 3)

Active-high outputs. Each Qn output divides the Clock input frequency by 2^N . The user should note the Q1, Q2, Q3 and Q11 are not available as outputs.

Osc Out 1, Osc Out 2 (Pins 9, 10)

Oscillator outputs. These pins are used in conjunction with Osc In and the external components to form an oscillator. When Osc In is being driven with an external clock source, Osc Out 1 and Osc Out 2 must be left open circuited. With the crystal oscillator configuration in Figure 6, Osc Out 2 must be left open circuited.

SWITCHING WAVEFORMS

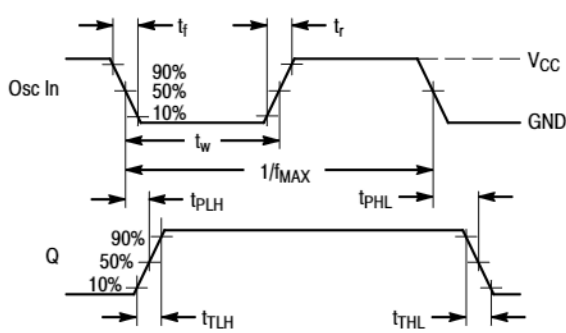

Figure 1.

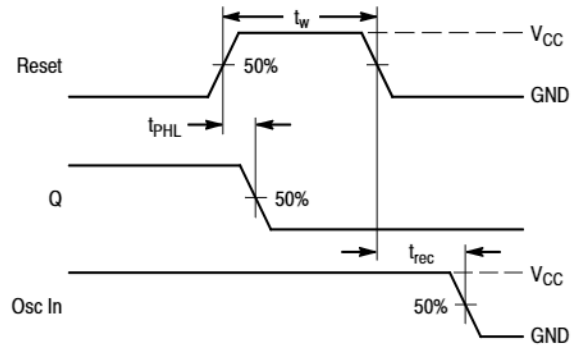

Figure 2.

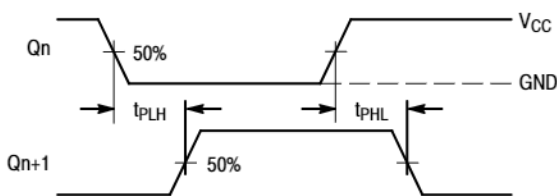
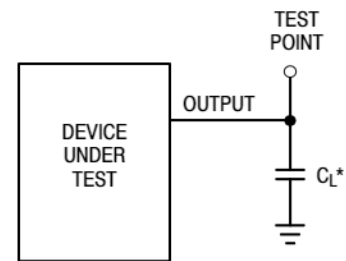

Figure 3.



*Includes all probe and jig capacitance

Figure 4. Test Circuit

MC74HC4060A

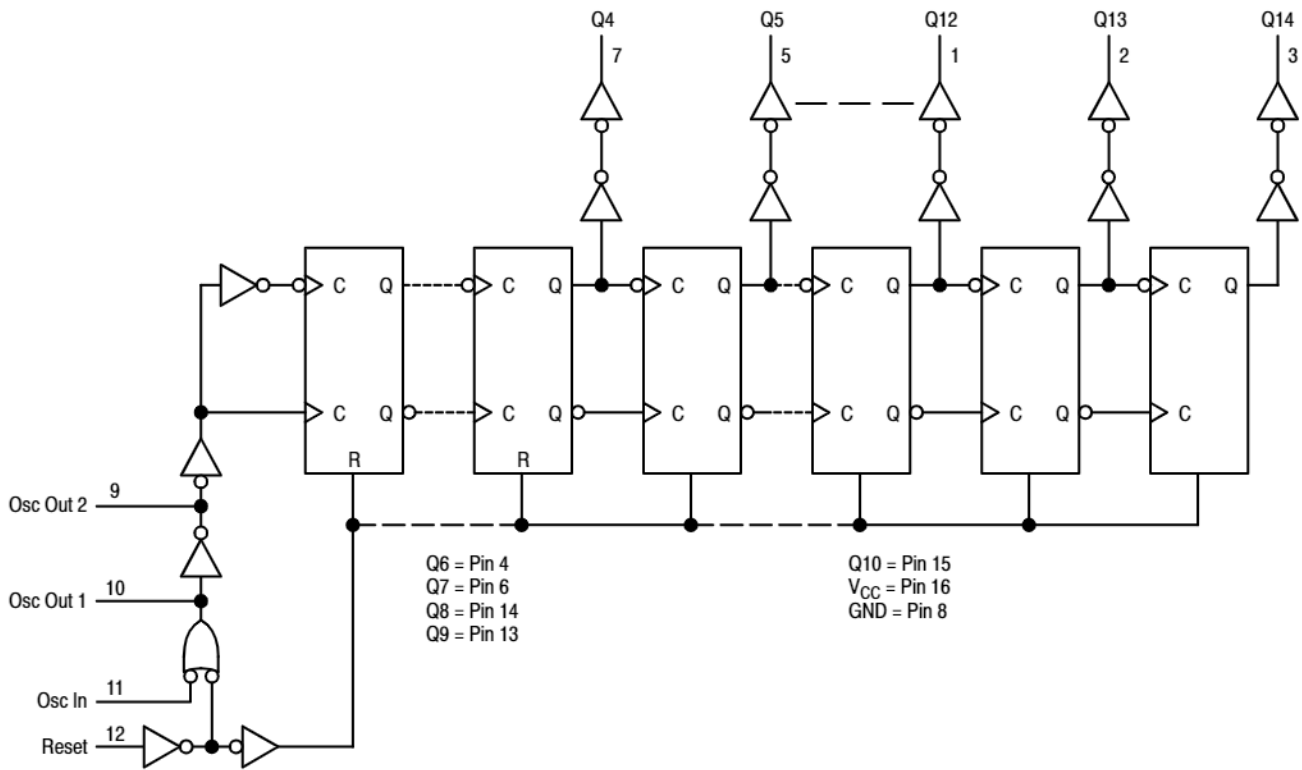

Figure 5. Expanded Logic Diagram

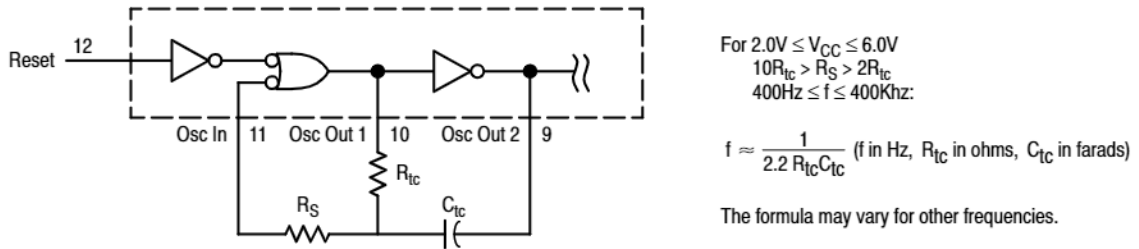

Figure 6. Oscillator Circuit Using RC Configuration

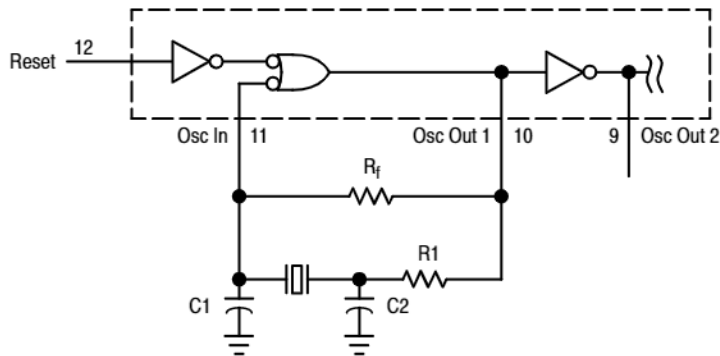

Figure 7. Pierce Crystal Oscillator Circuit

MC74HC4060A

TABLE 1. CRYSTAL OSCILLATOR AMPLIFIER SPECIFICATIONS ($T_A = 25^\circ\text{C}$; Input = Pin 11, Output = Pin 10)

Type	Positive Reactance (Pierce)	
Input Resistance, R_{in}	60M Ω Minimum	
Output Impedance, Z_{out} (4.5V Supply)	200 Ω (See Text)	
Input Capacitance, C_{in}	5pF Typical	
Output Capacitance, C_{out}	7pF Typical	
Series Capacitance, C_a	5pF Typical	
Open Loop Voltage Gain with Output at Full Swing, α	3Vdc Supply	5.0 Expected Minimum
	4Vdc Supply	4.0 Expected Minimum
	5Vdc Supply	3.3 Expected Minimum
	6Vdc Supply	3.1 Expected Minimum

PIERCE CRYSTAL OSCILLATOR DESIGN

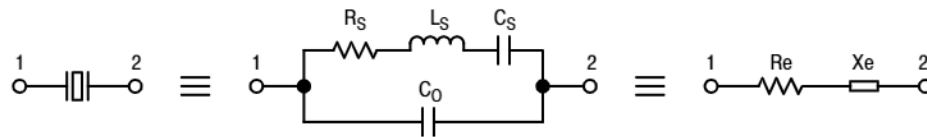

Value are supplied by crystal manufacturer (parallel resonant crystal).

Figure 8. Equivalent Crystal Networks

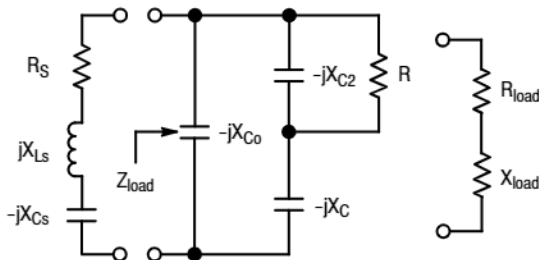

NOTE: $C = C_1 + C_{in}$ and $R = R_1 + R_{out}$. C_0 is considered as part of the load. C_a and R_f typically have minimal effect below 2MHz.

Figure 9. Series Equivalent Crystal Load

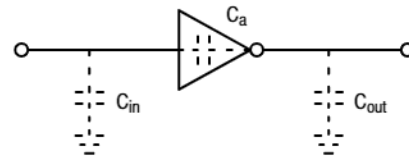

Values are listed in Table 1.

Figure 10. Parasitic Capacitances of the Amplifier

DESIGN PROCEDURES

The following procedure applies for oscillators operating below 2MHz where Z is a resistor R1. Above 2MHz, additional impedance elements should be considered: C_{out} and C_a of the amp, feedback resistor R_f, and amplifier phase shift error from 180°C.

Step 1: Calculate the equivalent series circuit of the crystal at the frequency of oscillation.

$$Z_e = \frac{-jX_{C_0}(R_s + jX_{L_s} - jX_{C_s})}{-jX_{C_0} + R_s + jX_{L_s} - jX_{C_s}} = R_e + jX_e$$

Reactance jX_e should be positive, indicating that the crystal is operating as an inductive reactance at the oscillation frequency. The maximum R_s for the crystal should be used in the equation.

Step 2: Determine β, the attenuation, of the feedback network. For a closed-loop gain of 2, A_vβ = 2, β = 2/A_v where A_v is the gain of the HC4060A amplifier.

Step 3: Determine the manufacturer's loading capacitance. For example: A manufacturer may specify an external load capacitance of 32pF at the required frequency.

Step 4: Determine the required Q of the system, and calculate R_{load}. For example, a manufacturer specifies a crystal Q of 100,000. In-circuit Q is arbitrarily set at 20% below crystal Q or 80,000. Then R_{load} = (2πf_oL_s/Q) - R_s where L_s and R_s are crystal parameters.

Step 5: Simultaneously solve, using a computer,

$$\beta = \frac{X_C \cdot X_{C2}}{R \cdot R_e + X_{C2}(X_e - X_C)} \quad (\text{with feedback phase shift} = 180^\circ) \quad (\text{Eq 1})$$

$$X_e = X_{C2} + X_C + \frac{R_e X_{C2}}{R} = X_{C_{load}} \quad (\text{where the loading capacitor is an external load, not including } C_0) \quad (\text{Eq 2})$$

$$R_{load} = \frac{R X_{C_0} X_{C2} [(X_C + X_{C2})(X_C + X_{C_0}) - X_C(X_C + X_{C_0} + X_{C2})]}{X^2_{C2}(X_C + X_{C_0})^2 + R^2(X_C + X_{C_0} + X_{C2})^2} \quad (\text{Eq 3})$$

Here R = R_{out} + R1. R_{out} is amp output resistance, R1 is Z. The C corresponding to X_C is given by C = C1 + C_{in}.

Alternately, pick a value for R1 (i.e, let R1 = R_s). Solve Equations 1 and 2 for C1 and C2. Use Equation 3 and the fact that Q = 2πf_oL_s/(R_s + R_{load}) to find in-circuit Q. If Q is not satisfactory pick another value for R1 and repeat the procedure.

CHOOSING R1

Power is dissipated in the effective series resistance of the crystal. The drive level specified by the crystal manufacturer is the maximum stress that a crystal can withstand without damage or excessive shift in frequency. R1 limits the drive level.

To verify that the maximum dc supply voltage does not overdrive the crystal, monitor the output frequency as a function of voltage at Osc Out 2 (Pin 9). The frequency should increase very slightly as the dc supply voltage is increased. An overdriven crystal will decrease in frequency or become unstable with an increase in supply voltage. The operating supply voltage must be reduced or R1 must be increased in value if the overdriven condition exists. The user should note that the oscillator start-up time is proportional to the value of R1.

SELECTING R_f

The feedback resistor, R_f, typically ranges up to 20MΩ. R_f determines the gain and bandwidth of the amplifier. Proper bandwidth insures oscillation at the correct frequency plus roll-off to minimize gain at undesirable frequencies, such as

the first overtone. R_f must be large enough so as to not affect the phase of the feedback network in an appreciable manner.

ACKNOWLEDGEMENTS AND RECOMMENDED REFERENCES

The following publications were used in preparing this data sheet and are hereby acknowledged and recommended for reading:

Technical Note TN-24, Statek Corp.

Technical Note TN-7, Statek Corp.

D. Babin, "Designing Crystal Oscillators", Machine Design, March 7, 1985.

D. Babin, "Guidelines for Crystal Oscillator Design", Machine Design, April 25, 1985.

ALSO RECOMMENDED FOR READING:

E. Hafner, "The Piezoelectric Crystal Unit-Definitions and Method of Measurement", Proc. IEEE, Vol. 57, No. 2, Feb., 1969.

D. Kemper, L. Rosine, "Quartz Crystals for Frequency Control", Electro-Technology, June, 1969.

P. J. Ottowitz, "A Guide to Crystal Selection", Electronic Design, May, 1966.

MC74HC4060A

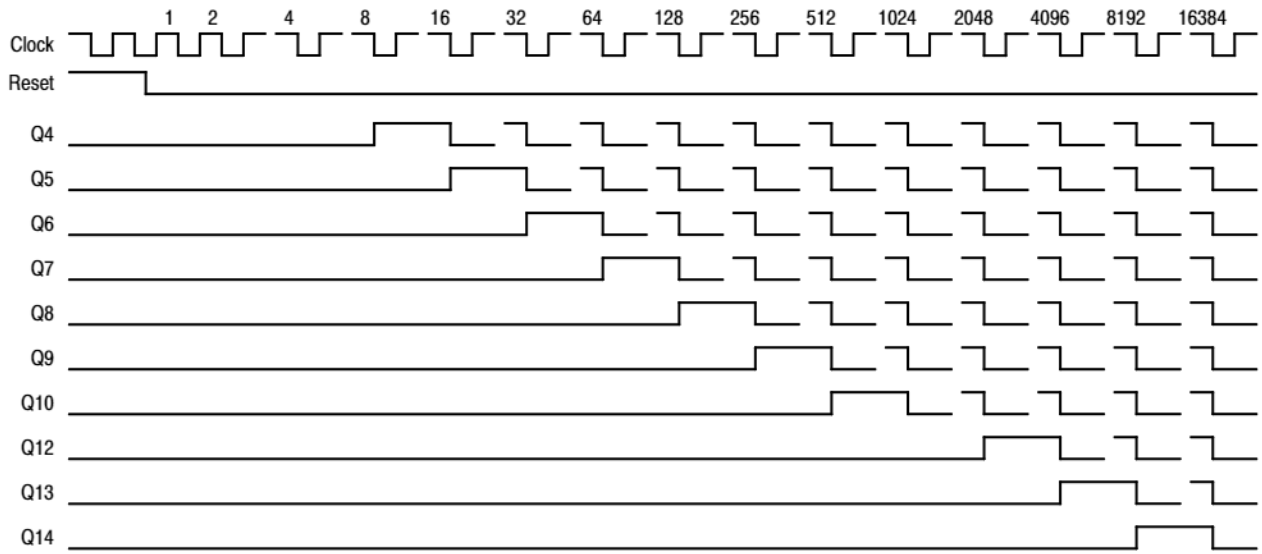
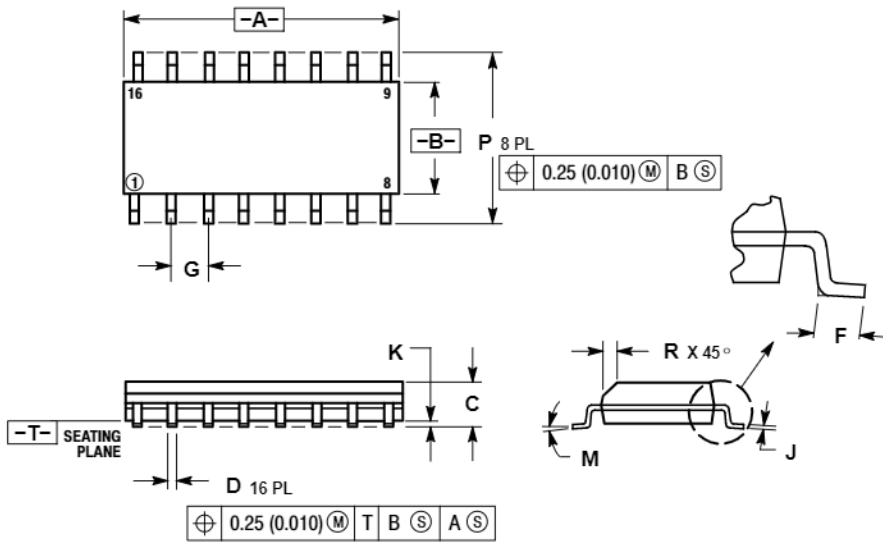

Figure 11. Timing Diagram

MC74HC4060A

PACKAGE DIMENSIONS

SOIC-16
CASE 751B-05
ISSUE K



NOTES:

1. DIMENSIONING AND TOLERANCING PER ANSI Y14.5M, 1982.
2. CONTROLLING DIMENSION: MILLIMETER.
3. DIMENSIONS A AND B DO NOT INCLUDE MOLD PROTRUSION.
4. MAXIMUM MOLD PROTRUSION 0.15 (0.006) PER SIDE.
5. DIMENSION D DOES NOT INCLUDE DAMBAR PROTRUSION. ALLOWABLE DAMBAR PROTRUSION SHALL BE 0.127 (0.005) TOTAL IN EXCESS OF THE D DIMENSION AT MAXIMUM MATERIAL CONDITION.

DIM	MILLIMETERS		INCHES	
	MIN	MAX	MIN	MAX
A	9.80	10.00	0.386	0.393
B	3.80	4.00	0.150	0.157
C	1.35	1.75	0.054	0.068
D	0.35	0.49	0.014	0.019
F	0.40	1.25	0.016	0.049
G	1.27	BSC	0.050	BSC
J	0.19	0.25	0.008	0.009
K	0.10	0.25	0.004	0.009
M	0°	7°	0°	7°
P	5.80	6.20	0.229	0.244
R	0.25	0.50	0.010	0.019

SOLDERING FOOTPRINT*

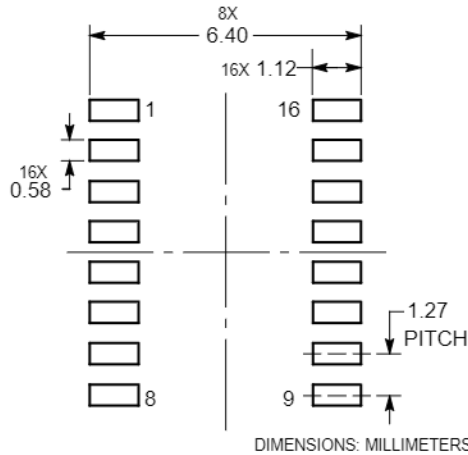

*For additional information on our Pb-Free strategy and soldering details, please download the ON Semiconductor Soldering and Mounting Techniques Reference Manual, SOLDERRM/D.

ON Semiconductor and are trademarks of Semiconductor Components Industries, LLC dba ON Semiconductor or its subsidiaries in the United States and/or other countries. ON Semiconductor owns the rights to a number of patents, trademarks, copyrights, trade secrets, and other intellectual property. A listing of ON Semiconductor's product/patent coverage may be accessed at www.onsemi.com/site/pdf/Patent-Marketing.pdf. ON Semiconductor reserves the right to make changes without further notice to any products herein. ON Semiconductor makes no warranty, representation or guarantee regarding the suitability of its products for any particular purpose, nor does ON Semiconductor assume any liability arising out of the application or use of any product or circuit, and specifically disclaims any and all liability, including without limitation special, consequential or incidental damages. Buyer is responsible for its products and applications using ON Semiconductor products, including compliance with all laws, regulations and safety requirements or standards, regardless of any support or applications information provided by ON Semiconductor. "Typical" parameters which may be provided in ON Semiconductor data sheets and/or specifications can and do vary in different applications and actual performance may vary over time. All operating parameters, including "Typicals" must be validated for each customer application by customer's technical experts. ON Semiconductor does not convey any license under its patent rights nor the rights of others. ON Semiconductor products are not designed, intended, or authorized for use as a critical component in life support systems or any FDA Class 3 medical devices or medical devices with a same or similar classification in a foreign jurisdiction or any devices intended for implantation in the human body. Should Buyer purchase or use ON Semiconductor products for any such unintended or unauthorized application, Buyer shall indemnify and hold ON Semiconductor and its officers, employees, subsidiaries, affiliates, and distributors harmless against all claims, costs, damages, and expenses, and reasonable attorney fees arising out of, directly or indirectly, any claim of personal injury or death associated with such unintended or unauthorized use, even if such claim alleges that ON Semiconductor was negligent regarding the design or manufacture of the part. ON Semiconductor is an Equal Opportunity/Affirmative Action Employer. This literature is subject to all applicable copyright laws and is not for resale in any manner.

PUBLICATION ORDERING INFORMATION

LITERATURE FULFILLMENT:
Literature Distribution Center for ON Semiconductor
19521 E. 32nd Pkwy, Aurora, Colorado 80011 USA
Phone: 303-675-2175 or 800-344-3860 Toll Free USA/Canada
Fax: 303-675-2176 or 800-344-3867 Toll Free USA/Canada
Email: orderlit@onsemi.com

N. American Technical Support: 800-282-9855 Toll Free
USA/Canada
Europe, Middle East and Africa Technical Support:
Phone: 421 33 790 2910
Japan Customer Focus Center
Phone: 81-3-5817-1050

ON Semiconductor Website: www.onsemi.com
Order Literature: <http://www.onsemi.com/orderlit>
For additional information, please contact your local Sales Representative