

LM833, NCV833

Low Noise, Audio Dual Operational Amplifier

The LM833 is a standard low-cost monolithic dual general-purpose operational amplifier employing Bipolar technology with innovative high-performance concepts for audio systems applications. With high frequency PNP transistors, the LM833 offers low voltage noise ($4.5 \text{ nV}/\sqrt{\text{Hz}}$), 15 MHz gain bandwidth product, 7.0 V/ μs slew rate, 0.3 mV input offset voltage with $2.0 \mu\text{V}/^\circ\text{C}$ temperature coefficient of input offset voltage. The LM833 output stage exhibits no dead-band crossover distortion, large output voltage swing, excellent phase and gain margins, low open loop high frequency output impedance and symmetrical source/sink AC frequency response.

For an improved performance dual/quad version, see the MC33079 family.

Features

- Low Voltage Noise: $4.5 \text{ nV}/\sqrt{\text{Hz}}$
- High Gain Bandwidth Product: 15 MHz
- High Slew Rate: 7.0 V/ μs
- Low Input Offset Voltage: 0.3 mV
- Low T.C. of Input Offset Voltage: $2.0 \mu\text{V}/^\circ\text{C}$
- Low Distortion: 0.002%
- Excellent Frequency Stability
- Dual Supply Operation
- NCV Prefix for Automotive and Other Applications Requiring Site and Change Controls
- These Devices are Pb-Free and are RoHS Compliant

MAXIMUM RATINGS

Rating	Symbol	Value	Unit
Supply Voltage (V_{CC} to V_{EE})	V_S	+36	V
Input Differential Voltage Range (Note 1)	V_{IDR}	30	V
Input Voltage Range (Note 1)	V_{IR}	± 15	V
Output Short Circuit Duration (Note 2)	t_{SC}	Indefinite	
Operating Ambient Temperature Range	T_A	-40 to +85	$^\circ\text{C}$
Operating Junction Temperature	T_J	+150	$^\circ\text{C}$
Storage Temperature	T_{stg}	-60 to +150	$^\circ\text{C}$
ESD Protection at any Pin – Human Body Model – Machine Model	V_{esd}	600 200	V
Maximum Power Dissipation (Notes 2 and 3)	P_D	500	mW

Stresses exceeding Maximum Ratings may damage the device. Maximum Ratings are stress ratings only. Functional operation above the Recommended Operating Conditions is not implied. Extended exposure to stresses above the Recommended Operating Conditions may affect device reliability.

1. Either or both input voltages must not exceed the magnitude of V_{CC} or V_{EE} .
2. Power dissipation must be considered to ensure maximum junction temperature (T_J) is not exceeded (see power dissipation performance characteristic).
3. Maximum value at $T_A \leq 85^\circ\text{C}$.



ON Semiconductor®

<http://onsemi.com>

MARKING DIAGRAMS



**PDIP-8
N SUFFIX
CASE 626**

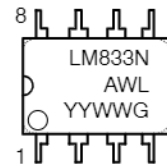

LM833N = Device Code
A = Assembly Location
WL = Wafer Lot
YY = Year
WW = Work Week
G = Pb-Free Package



**SOIC-8
D SUFFIX
CASE 751**

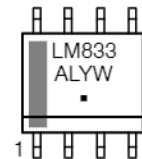

LM833 = Device Code
A = Assembly Location
L = Wafer Lot
Y = Year
W = Work Week
▪ = Pb-Free Package

PIN CONNECTIONS

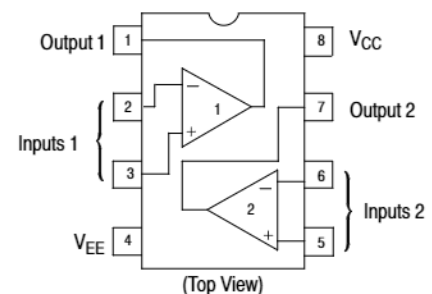

ORDERING INFORMATION

See detailed ordering and shipping information in the package dimensions section on page 6 of this data sheet.

LM833, NCV833

ELECTRICAL CHARACTERISTICS ($V_{CC} = +15\text{ V}$, $V_{EE} = -15\text{ V}$, $T_A = 25^\circ\text{C}$, unless otherwise noted.)

Characteristic	Symbol	Min	Typ	Max	Unit
Input Offset Voltage ($R_S = 10\ \Omega$, $V_O = 0\text{ V}$)	V_{IO}	-	0.3	5.0	mV
Average Temperature Coefficient of Input Offset Voltage $R_S = 10\ \Omega$, $V_O = 0\text{ V}$, $T_A = T_{low}$ to T_{high}	$\Delta V_{IO}/\Delta T$	-	2.0	-	$\mu\text{V}/^\circ\text{C}$
Input Offset Current ($V_{CM} = 0\text{ V}$, $V_O = 0\text{ V}$)	I_{IO}	-	10	200	nA
Input Bias Current ($V_{CM} = 0\text{ V}$, $V_O = 0\text{ V}$)	I_{IB}	-	300	1000	nA
Common Mode Input Voltage Range	V_{ICR}	-12	+14 -14	+12 -	V
Large Signal Voltage Gain ($R_L = 2.0\text{ k}\Omega$, $V_O = \pm 10\text{ V}$)	A_{VOL}	90	110	-	dB
Output Voltage Swing: $R_L = 2.0\text{ k}\Omega$, $V_{ID} = 1.0\text{ V}$ $R_L = 2.0\text{ k}\Omega$, $V_{ID} = 1.0\text{ V}$ $R_L = 10\text{ k}\Omega$, $V_{ID} = 1.0\text{ V}$ $R_L = 10\text{ k}\Omega$, $V_{ID} = 1.0\text{ V}$	V_{O+} V_{O-} V_{O+} V_{O-}	10 - 12 -	13.7 -14.1 13.9 -14.7	- -10 - -12	V
Common Mode Rejection ($V_{in} = \pm 12\text{ V}$)	CMR	80	100	-	dB
Power Supply Rejection ($V_S = 15\text{ V}$ to 5.0 V , -15 V to -5.0 V)	PSR	80	115	-	dB
Power Supply Current ($V_O = 0\text{ V}$, Both Amplifiers)	I_D	-	4.0	8.0	mA

AC ELECTRICAL CHARACTERISTICS ($V_{CC} = +15\text{ V}$, $V_{EE} = -15\text{ V}$, $T_A = 25^\circ\text{C}$, unless otherwise noted.)

Characteristic	Symbol	Min	Typ	Max	Unit
Slew Rate ($V_{in} = -10\text{ V}$ to $+10\text{ V}$, $R_L = 2.0\text{ k}\Omega$, $A_V = +1.0$)	S_R	5.0	7.0	-	$\text{V}/\mu\text{s}$
Gain Bandwidth Product ($f = 100\text{ kHz}$)	GBW	10	15	-	MHz
Unity Gain Frequency (Open Loop)	f_U	-	9.0	-	MHz
Unity Gain Phase Margin (Open Loop)	θ_m	-	60	-	$^\circ$
Equivalent Input Noise Voltage ($R_S = 100\ \Omega$, $f = 1.0\text{ kHz}$)	e_n	-	4.5	-	$\text{nV}/\sqrt{\text{Hz}}$
Equivalent Input Noise Current ($f = 1.0\text{ kHz}$)	i_n	-	0.5	-	$\text{pA}/\sqrt{\text{Hz}}$
Power Bandwidth ($V_O = 27\text{ V}_{pp}$, $R_L = 2.0\text{ k}\Omega$, $\text{THD} \leq 1.0\%$)	BWP	-	120	-	kHz
Distortion ($R_L = 2.0\text{ k}\Omega$, $f = 20\text{ Hz}$ to 20 kHz , $V_O = 3.0\text{ V}_{rms}$, $A_V = +1.0$)	THD	-	0.002	-	%
Channel Separation ($f = 20\text{ Hz}$ to 20 kHz)	C_S	-	-120	-	dB

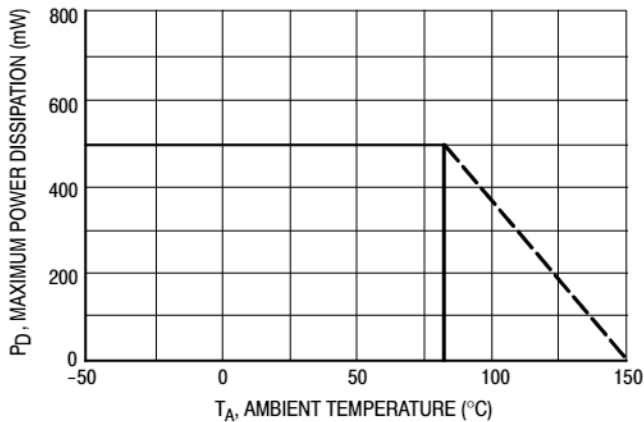

Figure 1. Maximum Power Dissipation versus Temperature

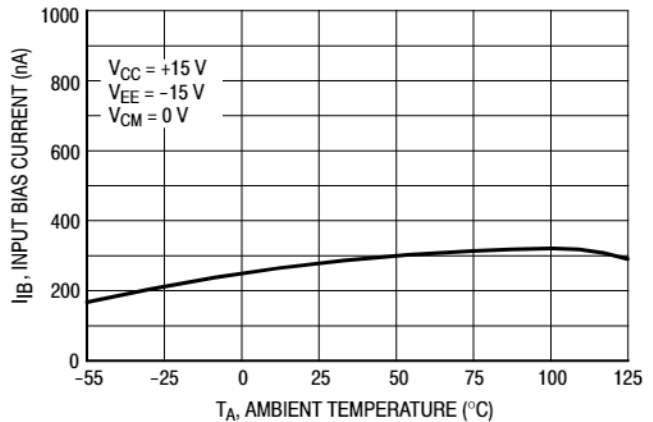

Figure 2. Input Bias Current versus Temperature

LM833, NCV833

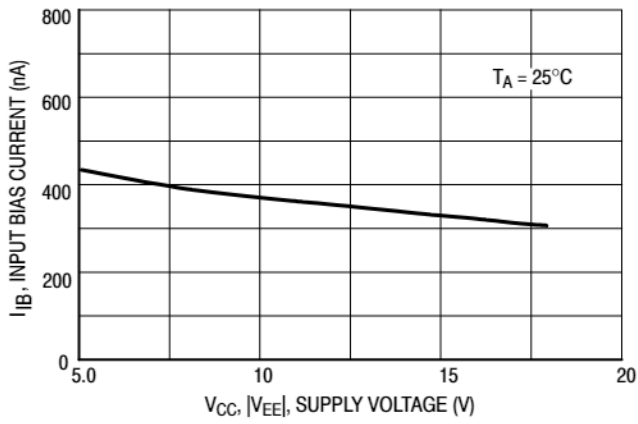

Figure 3. Input Bias Current versus Supply Voltage

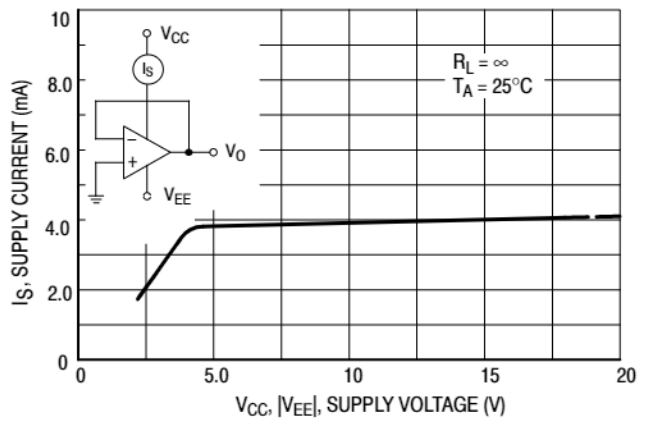

Figure 4. Supply Current versus Supply Voltage

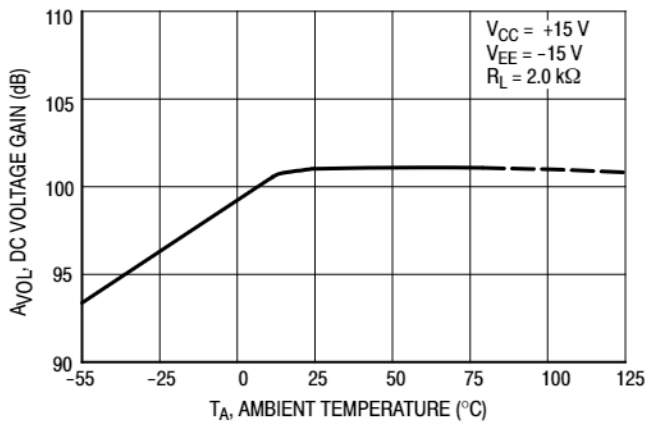

Figure 5. DC Voltage Gain versus Temperature

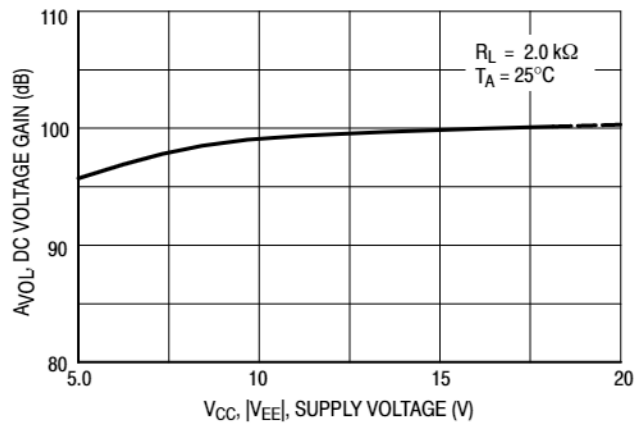

Figure 6. DC Voltage Gain versus Supply Voltage

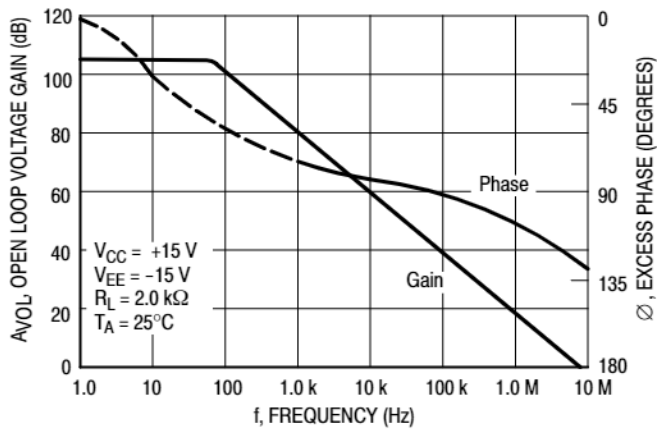

Figure 7. Open Loop Voltage Gain and Phase versus Frequency

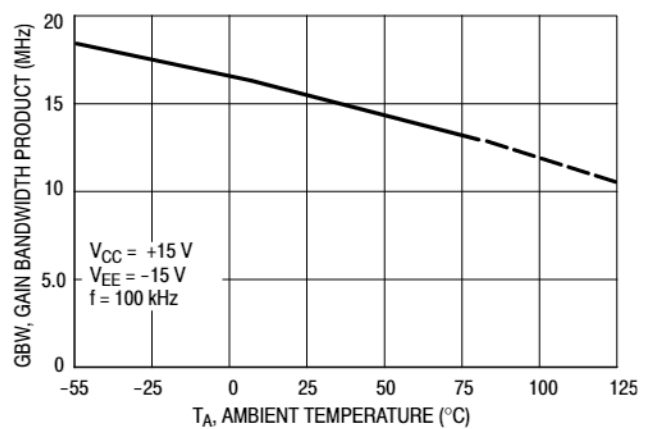

Figure 8. Gain Bandwidth Product versus Temperature

LM833, NCV833

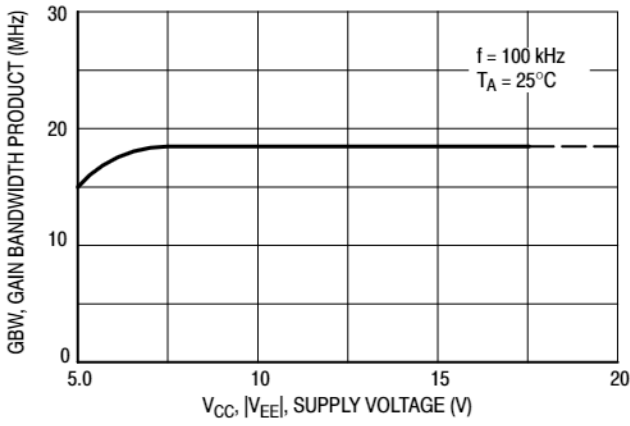

Figure 9. Gain Bandwidth Product versus Supply Voltage

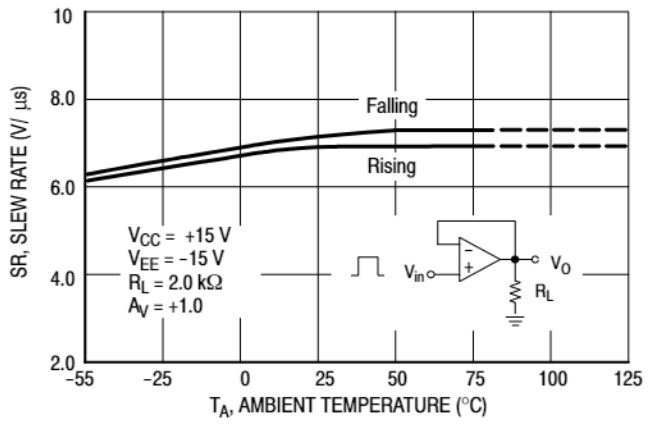

Figure 10. Slew Rate versus Temperature

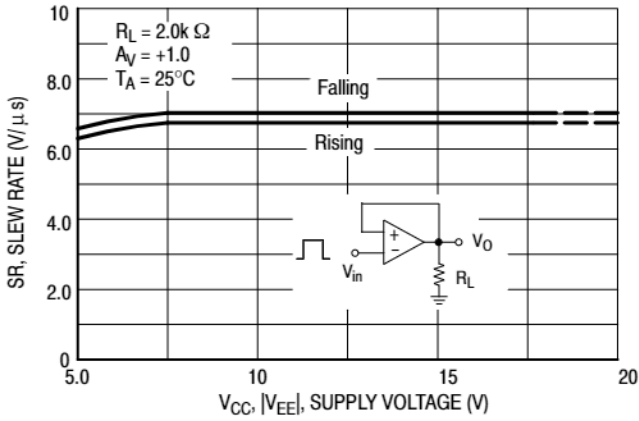

Figure 11. Slew Rate versus Supply Voltage

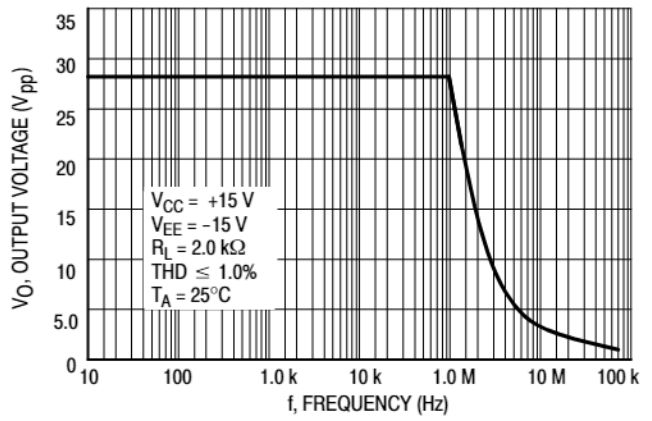

Figure 12. Output Voltage versus Frequency

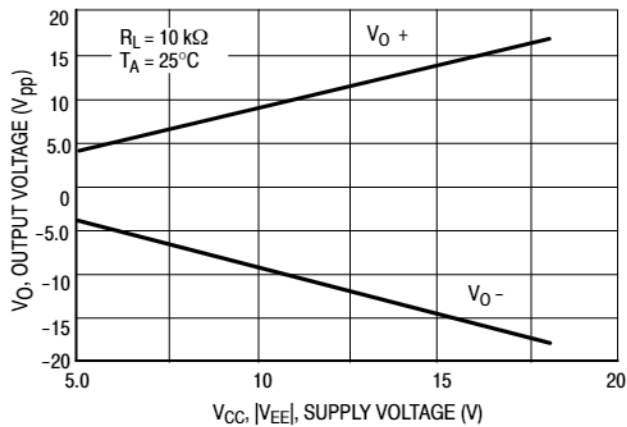

Figure 13. Maximum Output Voltage versus Supply Voltage

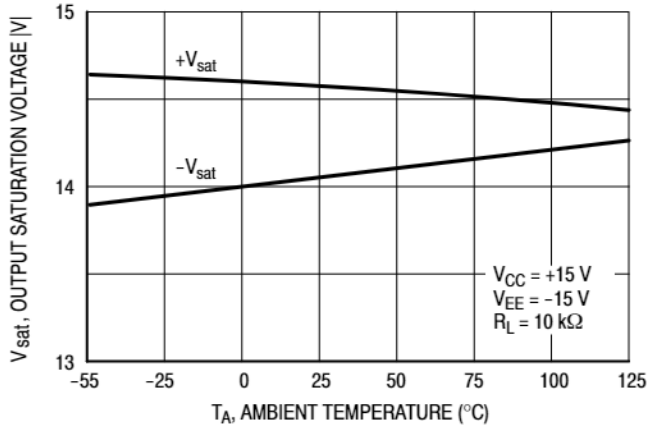

Figure 14. Output Saturation Voltage versus Temperature

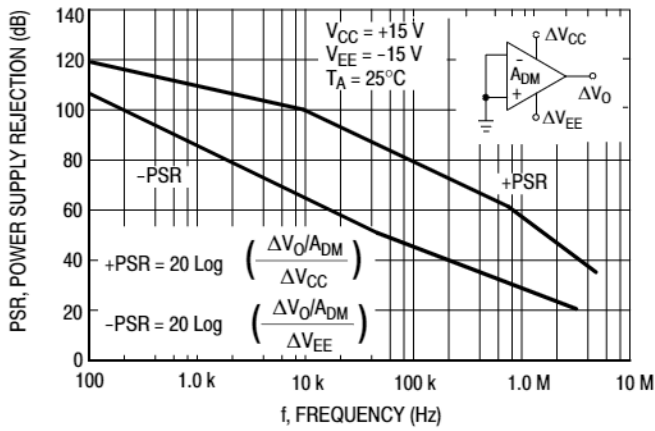

Figure 15. Power Supply Rejection versus Frequency

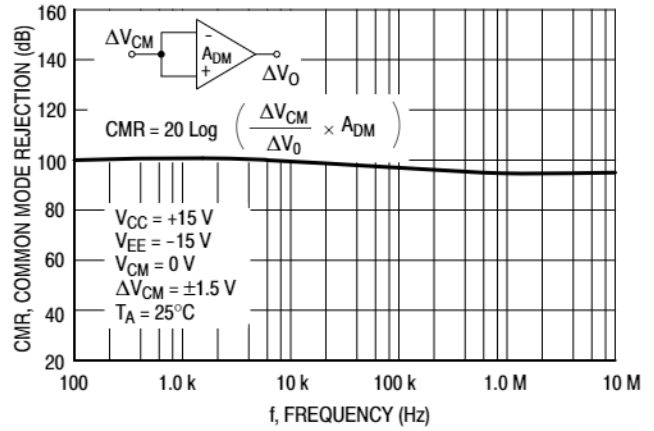

Figure 16. Common Mode Rejection versus Frequency

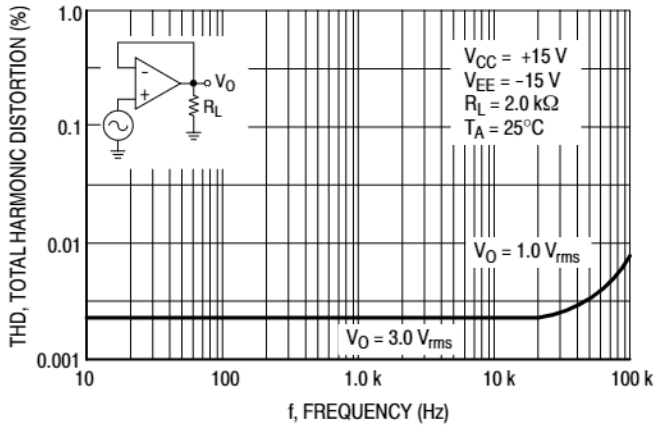

Figure 17. Total Harmonic Distortion versus Frequency

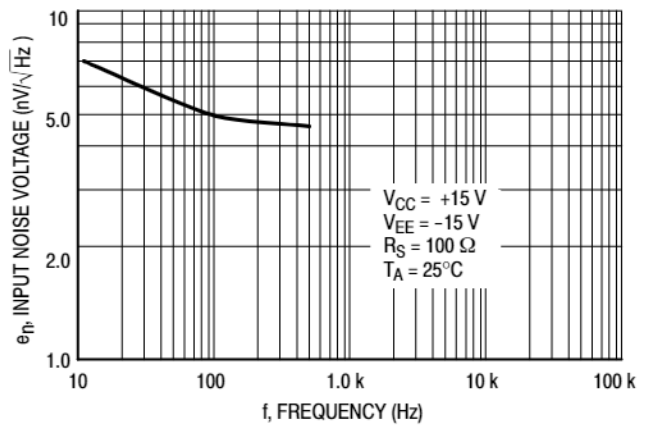

Figure 18. Input Referred Noise Voltage versus Frequency

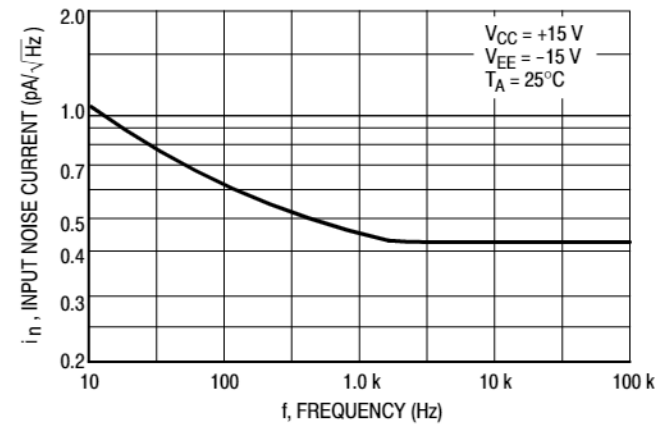

Figure 19. Input Referred Noise Current versus Frequency

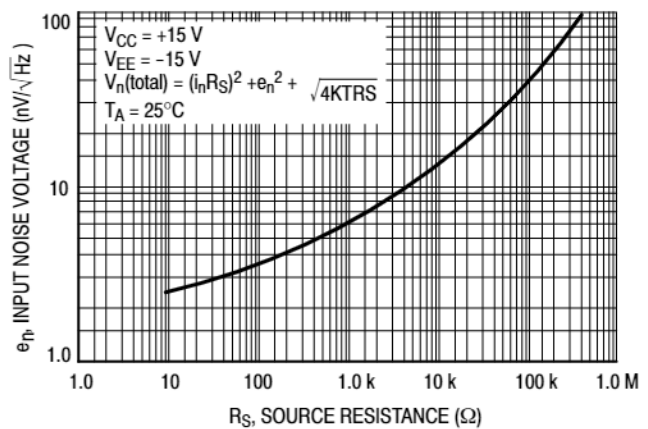

Figure 20. Input Referred Noise Voltage versus Source Resistance

LM833, NCV833

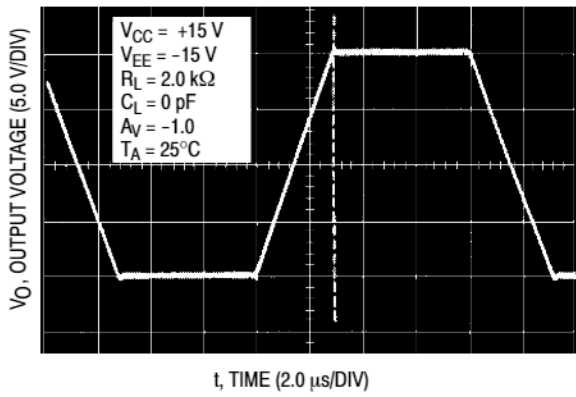

Figure 21. Inverting Amplifier

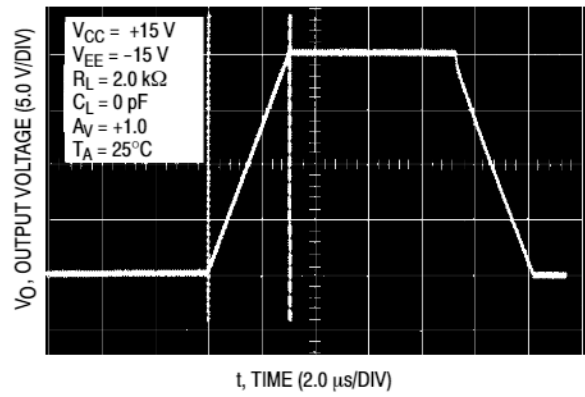

Figure 22. Noninverting Amplifier Slew Rate

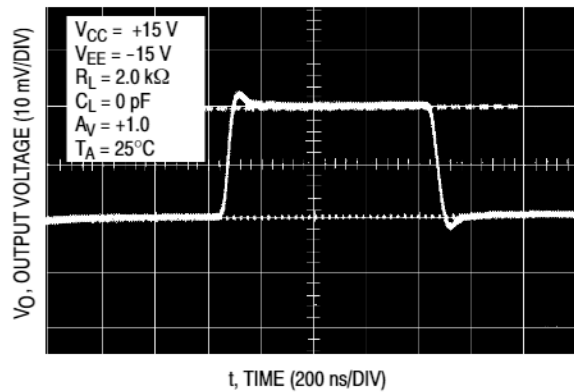

Figure 23. Noninverting Amplifier Overshoot

ORDERING INFORMATION

Device	Package	Shipping [†]
LM833NG	PDIP-8 (Pb-Free)	50 Units / Rail
LM833DG	SOIC-8 (Pb-Free)	98 Units / Rail
LM833DR2G	SOIC-8 (Pb-Free)	2500 / Tape & Reel
NCV833DR2G*	SOIC-8 (Pb-Free)	2500 / Tape & Reel

[†]For information on tape and reel specifications, including part orientation and tape sizes, please refer to our Tape and Reel Packaging Specifications Brochure, BRD8011/D.

*NCV prefix indicates qualified for automotive use.

LM833, NCV833

PACKAGE DIMENSIONS

PDIP-8
N SUFFIX
CASE 626-05
ISSUE M

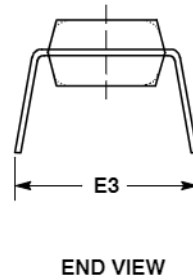
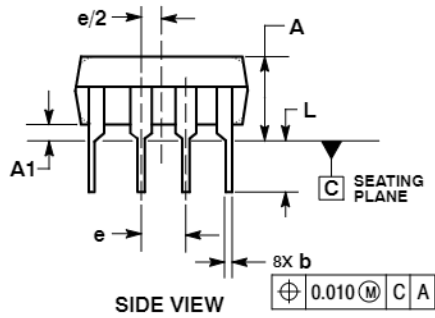
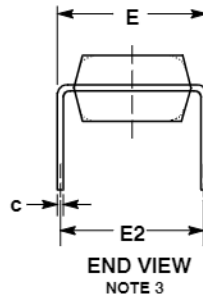
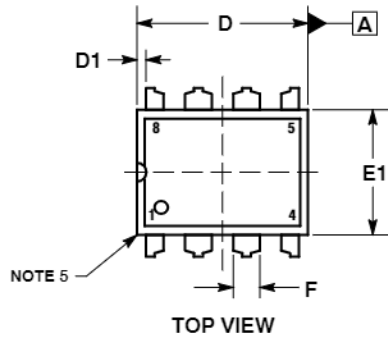

NOTES:

1. DIMENSIONING AND TOLERANCING PER ASME Y14.5M, 1994.
2. CONTROLLING DIMENSION: INCHES.
3. DIMENSION E IS MEASURED WITH THE LEADS RESTRAINED PARALLEL AT WIDTH E2.
4. DIMENSION E1 DOES NOT INCLUDE MOLD FLASH.
5. ROUNDED CORNERS OPTIONAL.

DIM	INCHES			MILLIMETERS		
	MIN	NOM	MAX	MIN	NOM	MAX
A	----	----	0.210	----	----	5.33
A1	0.015	----	----	0.38	----	----
b	0.014	0.018	0.022	0.35	0.46	0.56
C	0.008	0.010	0.014	0.20	0.25	0.36
D	0.355	0.365	0.400	9.02	9.27	10.02
D1	0.005	----	----	0.13	----	----
E	0.300	0.310	0.325	7.62	7.87	8.26
E1	0.240	0.250	0.280	6.10	6.35	7.11
E2	0.300 BSC			7.62 BSC		
E3	----	----	0.430	----	----	10.92
e	0.100 BSC			2.54 BSC		
L	0.115	0.130	0.150	2.92	3.30	3.81

LM833, NCV833

PACKAGE DIMENSIONS

SOIC-8
D SUFFIX
CASE 751-07
ISSUE AK

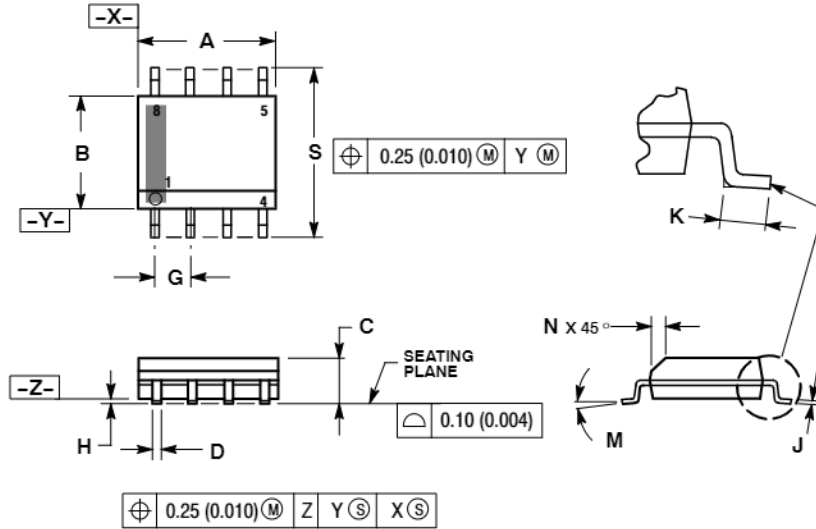

NOTES:

1. DIMENSIONING AND TOLERANCING PER ANSI Y14.5M, 1982.
2. CONTROLLING DIMENSION: MILLIMETER.
3. DIMENSION A AND B DO NOT INCLUDE MOLD PROTRUSION.
4. MAXIMUM MOLD PROTRUSION 0.15 (0.006) PER SIDE.
5. DIMENSION D DOES NOT INCLUDE DAMBAR PROTRUSION. ALLOWABLE DAMBAR PROTRUSION SHALL BE 0.127 (0.005) TOTAL IN EXCESS OF THE D DIMENSION AT MAXIMUM MATERIAL CONDITION.
6. 751-01 THRU 751-06 ARE OBSOLETE. NEW STANDARD IS 751-07.

DIM	MILLIMETERS		INCHES	
	MIN	MAX	MIN	MAX
A	4.80	5.00	0.189	0.197
B	3.80	4.00	0.150	0.157
C	1.35	1.75	0.053	0.069
D	0.33	0.51	0.013	0.020
G	1.27 BSC		0.050 BSC	
H	0.10	0.25	0.004	0.010
J	0.19	0.25	0.007	0.010
K	0.40	1.27	0.016	0.050
M	0 [°]	8 [°]	0 [°]	8 [°]
N	0.25	0.50	0.010	0.020
S	5.80	6.20	0.228	0.244

SOLDERING FOOTPRINT*

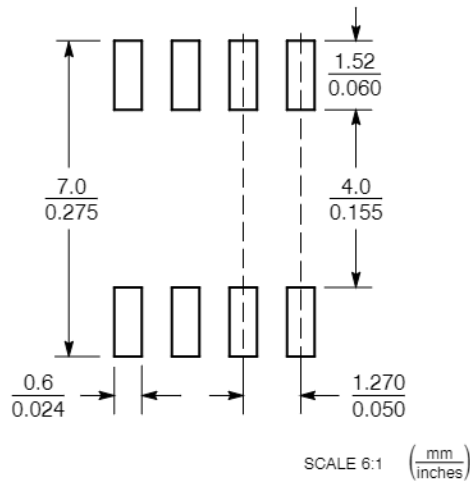

*For additional information on our Pb-Free strategy and soldering details, please download the ON Semiconductor Soldering and Mounting Techniques Reference Manual, SOLDERRM/D.

ON Semiconductor and are registered trademarks of Semiconductor Components Industries, LLC (SCILLC). SCILLC reserves the right to make changes without further notice to any products herein. SCILLC makes no warranty, representation or guarantee regarding the suitability of its products for any particular purpose, nor does SCILLC assume any liability arising out of the application or use of any product or circuit, and specifically disclaims any and all liability, including without limitation special, consequential or incidental damages. "Typical" parameters which may be provided in SCILLC data sheets and/or specifications can and do vary in different applications and actual performance may vary over time. All operating parameters, including "Typicals" must be validated for each customer application by customer's technical experts. SCILLC does not convey any license under its patent rights nor the rights of others. SCILLC products are not designed, intended, or authorized for use as components in systems intended for surgical implant into the body, or other applications intended to support or sustain life, or for any other application in which the failure of the SCILLC product could create a situation where personal injury or death may occur. Should Buyer purchase or use SCILLC products for any such unintended or unauthorized application, Buyer shall indemnify and hold SCILLC and its officers, employees, subsidiaries, affiliates, and distributors harmless against all claims, costs, damages, and expenses, and reasonable attorney fees arising out of, directly or indirectly, any claim of personal injury or death associated with such unintended or unauthorized use, even if such claim alleges that SCILLC was negligent regarding the design or manufacture of the part. SCILLC is an Equal Opportunity/Affirmative Action Employer. This literature is subject to all applicable copyright laws and is not for resale in any manner.

PUBLICATION ORDERING INFORMATION

LITERATURE FULFILLMENT:

Literature Distribution Center for ON Semiconductor
P.O. Box 5163, Denver, Colorado 80217 USA
Phone: 303-675-2175 or 800-344-3860 Toll Free USA/Canada
Fax: 303-675-2176 or 800-344-3867 Toll Free USA/Canada
Email: orderlit@onsemi.com

N. American Technical Support: 800-282-9855 Toll Free
USA/Canada
Europe, Middle East and Africa Technical Support:
Phone: 421 33 790 2910
Japan Customer Focus Center
Phone: 81-3-5773-3850

ON Semiconductor Website: www.onsemi.com

Order Literature: <http://www.onsemi.com/orderlit>

For additional information, please contact your local Sales Representative