

MC78M00, MC78M00A, NCV78M00 Series

500 mA Positive Voltage Regulators

The MC78M00/MC78M00A Series positive voltage regulators are identical to the popular MC7800 Series devices, except that they are specified for only half the output current. Like the MC7800 devices, the MC78M00 three-terminal regulators are intended for local, on-card voltage regulation.

Internal current limiting, thermal shutdown circuitry and safe-area compensation for the internal pass transistor combine to make these devices remarkably rugged under most operating conditions. Maximum output current, with adequate heatsinking is 500 mA.

Features

- No External Components Required
- Internal Thermal Overload Protection
- Internal Short Circuit Current Limiting
- Output Transistor Safe-Area Compensation
- MC78M00A High Accuracy ($\pm 2\%$)
Available for 5.0 V, 8.0 V, 12 V and 15 V
- NCV Prefix for Automotive and Other Applications Requiring Unique Site and Control Change Requirements; AEC-Q100 Qualified and PPAP Capable
- These are Pb-Free Devices

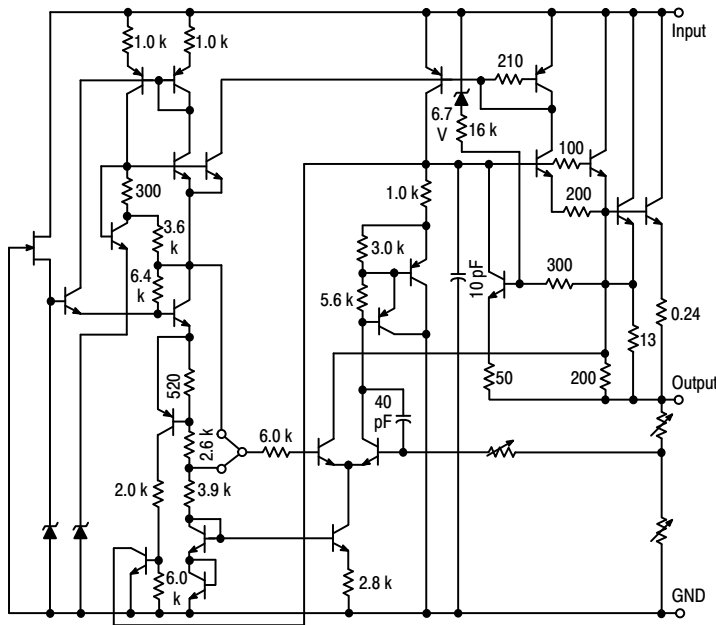

This device contains 28 active transistors.

Figure 1. Representative Schematic Diagram



ON Semiconductor®

www.onsemi.com

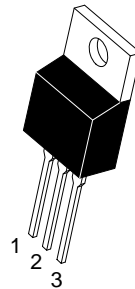

**TO-220
T SUFFIX
CASE 221AB**

Heatsink surface
connected to Pin 2.

MARKING DIAGRAMS

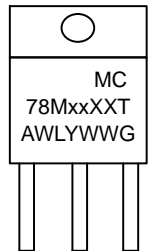

xx = Voltage Option
XX = Appropriate Suffix Options
A = Assembly Location
WL = Wafer Lot
Y = Year
WW = Work Week
G = Pb-Free Package

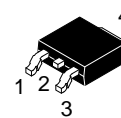

**DPAK-3
DT SUFFIX
CASE 369C**

Heatsink surface (shown as terminal 4 in
case outline drawing) is connected to Pin 2.

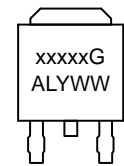

xxxxx = Device Type and Voltage Option Code
A = Assembly Location
L = Wafer Lot
Y = Year
WW = Work Week
G = Pb-Free Package

Pin 1. Input
2. Ground
3. Output

ORDERING INFORMATION

See detailed ordering and shipping information in the package dimensions section on page 10-14 of this data sheet.

DEVICE MARKING INFORMATION

See general marking information in the device marking section on page 10 of this data sheet.

MC78M00, MC78M00A, NCV78M00 Series

MAXIMUM RATINGS ($T_A = 25^\circ\text{C}$, unless otherwise noted) (Note 1)

Rating	Symbol	Value	Unit
Input Voltage (5.0 V–18 V) (20 V–24V)	V_I	35 40	Vdc
Power Dissipation (Package Limitation) Plastic Package, T Suffix $T_A = 25^\circ\text{C}$ Thermal Resistance, Junction-to-Air Thermal Resistance, Junction-to-Case Plastic Package, DT Suffix $T_A = 25^\circ\text{C}$ Thermal Resistance, Junction-to-Air Thermal Resistance, Junction-to-Case	P_D θ_{JA} θ_{JC} P_D θ_{JA} θ_{JC}	Internally Limited 70 5.0 Internally Limited 92 5.0	$^\circ\text{C}/\text{W}$
Operating Junction Temperature Range	T_J	+150	$^\circ\text{C}$
Storage Temperature Range	T_{stg}	-65 to +150	$^\circ\text{C}$

Stresses exceeding those listed in the Maximum Ratings table may damage the device. If any of these limits are exceeded, device functionality should not be assumed, damage may occur and reliability may be affected.

- This device series contains ESD protection and exceeds the following tests:
Human Body Model 2000 V per MIL-STD-883, Method 3015.
Machine Model Method 200 V.

MC78M05C/AC/B/AB, NCV78M05AB/B ELECTRICAL CHARACTERISTICS

($V_I = 10\text{ V}$, $I_O = 350\text{ mA}$, $T_J = T_{low}$ to T_{high} , $P_D \leq 5\text{ W}$, unless otherwise noted) (Note 2)

Characteristics	Symbol	Min	Typ	Max	Unit
Output Voltage ($T_J = 25^\circ\text{C}$) MC78M05B/MC78M05C/NCV78M05B MC78M05AB/MC78M05AC/NCV78M05AB	V_O	4.8 4.9	5.0 5.0	5.2 5.1	Vdc
Output Voltage Variation ($7.0\text{ Vdc} \leq V_I \leq 20\text{ Vdc}$, $5.0\text{ mA} \leq I_O \leq 350\text{ mA}$) MC78M05B/MC78M05C/NCV78M05B MC78M05AB/MC78M05AC/NCV78M05AB	V_O	4.75 4.80	– –	5.25 5.20	Vdc
Line Regulation ($T_J = 25^\circ\text{C}$, $7.0\text{ Vdc} \leq V_I \leq 25\text{ Vdc}$, $I_O = 200\text{ mA}$)	Reg_{line}	–	3.0	50	mV
Load Regulation ($T_J = 25^\circ\text{C}$, $5.0\text{ mA} \leq I_O \leq 500\text{ mA}$) ($T_J = 25^\circ\text{C}$, $5.0\text{ mA} \leq I_O \leq 200\text{ mA}$)	Reg_{load}	– –	20 10	100 50	mV
Input Bias Current ($T_J = 25^\circ\text{C}$)	I_{IB}	–	3.2	6.0	mA
Quiescent Current Change ($8.0\text{ Vdc} \leq V_I \leq 25\text{ Vdc}$, $I_O = 200\text{ mA}$) ($5.0\text{ mA} \leq I_O \leq 350\text{ mA}$)	ΔI_{IB}	– –	– –	0.8 0.5	mA
Output Noise Voltage ($T_A = 25^\circ\text{C}$, $10\text{ Hz} \leq f \leq 100\text{ kHz}$)	V_n	–	40	–	μV
Ripple Rejection ($I_O = 100\text{ mA}$, $f = 120\text{ Hz}$, $8.0\text{ V} \leq V_I \leq 18\text{ V}$) ($I_O = 300\text{ mA}$, $f = 120\text{ Hz}$, $8.0 \leq V_I \leq 18\text{ V}$, $T_J = 25^\circ\text{C}$)	RR	62 62	– 80	– –	dB
Dropout Voltage ($T_J = 25^\circ\text{C}$)	$V_I - V_O$	–	2.0	–	Vdc
Short Circuit Current Limit ($T_J = 25^\circ\text{C}$, $V_I = 35\text{ V}$)	I_{OS}	–	350	–	mA
Average Temperature Coefficient of Output Voltage ($I_O = 5.0\text{ mA}$)	$\Delta V_O / \Delta T$	–	± 0.2	–	$\text{mV}/^\circ\text{C}$
Peak Output Current ($T_J = 25^\circ\text{C}$)	I_O	–	700	–	mA

- $T_{low} = 0^\circ\text{C}$ for MC78MxxAC, C
= -40°C for MC78MxxAB, B, NCV78MxxAB, B
 $T_{high} = +125^\circ\text{C}$ for MC78MxxAB, AC, B, C, NCV78MxxAB, B

MC78M00, MC78M00A, NCV78M00 Series

MC78M06C/B ELECTRICAL CHARACTERISTICS

($V_I = 11\text{ V}$, $I_O = 350\text{ mA}$, $T_J = T_{\text{low}}$ to T_{high} , $P_D \leq 5.0\text{ W}$, unless otherwise noted) (Note 3)

Characteristics	Symbol	Min	Typ	Max	Unit
Output Voltage ($T_J = 25^\circ\text{C}$)	V_O	5.75	6.0	6.25	Vdc
Output Voltage Variation ($8.0\text{ Vdc} \leq V_I \leq 21\text{ Vdc}$, $5.0\text{ mA} \leq I_O \leq 350\text{ mA}$)	V_O	5.7	–	6.3	Vdc
Line Regulation ($T_J = 25^\circ\text{C}$, $8.0\text{ Vdc} \leq V_I \leq 25\text{ Vdc}$, $I_O = 200\text{ mA}$)	Reg_{line}	–	5.0	50	mV
Load Regulation ($T_J = 25^\circ\text{C}$, $5.0\text{ mA} \leq I_O \leq 500\text{ mA}$) ($T_J = 25^\circ\text{C}$, $5.0\text{ mA} \leq I_O \leq 200\text{ mA}$)	Reg_{load}	– –	20 10	120 60	mV
Input Bias Current ($T_J = 25^\circ\text{C}$)	I_{IB}	–	3.2	6.0	mA
Quiescent Current Change ($9.0\text{ Vdc} \leq V_I \leq 25\text{ Vdc}$, $I_O = 200\text{ mA}$) ($5.0\text{ mA} \leq I_O \leq 350\text{ mA}$)	ΔI_{IB}	– –	– –	0.8 0.5	mA
Output Noise Voltage ($T_A = 25^\circ\text{C}$, $10\text{ Hz} \leq f \leq 100\text{ kHz}$)	V_n	–	45	–	μV
Ripple Rejection ($I_O = 100\text{ mA}$, $f = 120\text{ Hz}$, $9.0\text{ V} \leq V_I \leq 19\text{ V}$) ($I_O = 300\text{ mA}$, $f = 120\text{ Hz}$, $9.0\text{ V} \leq V_I \leq 19\text{ V}$, $T_J = 25^\circ\text{C}$)	RR	59 59	– 80	– –	dB
Dropout Voltage ($T_J = 25^\circ\text{C}$)	$V_I - V_O$	–	2.0	–	Vdc
Short Circuit Current Limit ($T_J = 25^\circ\text{C}$, $V_I = 35\text{ V}$)	I_{OS}	–	350	–	mA
Average Temperature Coefficient of Output Voltage ($I_O = 5.0\text{ mA}$)	$\Delta V_O / \Delta T$	–	± 0.2	–	$\text{mV}/^\circ\text{C}$
Peak Output Current ($T_J = 25^\circ\text{C}$)	I_O	–	700	–	mA

MC78M08C/AC/B/AB, NCV78M08B ELECTRICAL CHARACTERISTICS

($V_I = 14\text{ V}$, $I_O = 350\text{ mA}$, $T_J = T_{\text{low}}$ to T_{high} , $P_D \leq 5\text{ W}$, unless otherwise noted) (Note 3)

Characteristics	Symbol	Min	Typ	Max	Unit
Output Voltage ($T_J = 25^\circ\text{C}$) MC78M08B/MC78M08C/NCV78M08B MC78M08AB/MC78M08AC	V_O	7.70 7.84	8.0 8.0	8.30 8.16	Vdc
Output Voltage Variation ($10.5\text{ Vdc} \leq V_I \leq 23\text{ Vdc}$, $5.0\text{ mA} \leq I_O \leq 350\text{ mA}$) MC78M08B/MC78M08C/NCV78M08B MC78M08AB/MC78M08AC	V_O	7.6 7.7	– –	8.4 8.3	Vdc
Line Regulation ($T_J = 25^\circ\text{C}$, $10.5\text{ Vdc} \leq V_I \leq 25\text{ Vdc}$, $I_O = 200\text{ mA}$)	Reg_{line}	–	6.0	50	mV
Load Regulation ($T_J = 25^\circ\text{C}$, $5.0\text{ mA} \leq I_O \leq 500\text{ mA}$) ($T_J = 25^\circ\text{C}$, $5.0\text{ mA} \leq I_O \leq 200\text{ mA}$)	Reg_{load}	– –	25 10	160 80	mV
Input Bias Current ($T_J = 25^\circ\text{C}$)	I_{IB}	–	3.2	6.0	mA
Quiescent Current Change ($10.5\text{ Vdc} \leq V_I \leq 25\text{ Vdc}$, $I_O = 200\text{ mA}$) ($5.0\text{ mA} \leq I_O \leq 350\text{ mA}$)	ΔI_{IB}	– –	– –	0.8 0.5	mA
Output Noise Voltage ($T_A = 25^\circ\text{C}$, $10\text{ Hz} \leq f \leq 100\text{ kHz}$)	V_n	–	52	–	μV
Ripple Rejection ($I_O = 100\text{ mA}$, $f = 120\text{ Hz}$, $11.5\text{ V} \leq V_I \leq 21.5\text{ V}$) ($I_O = 300\text{ mA}$, $f = 120\text{ Hz}$, $11.5\text{ V} \leq V_I \leq 21.5\text{ V}$, $T_J = 25^\circ\text{C}$)	RR	56 56	– 80	– –	dB
Dropout Voltage ($T_J = 25^\circ\text{C}$)	$V_I - V_O$	–	2.0	–	Vdc
Short Circuit Current Limit ($T_J = 25^\circ\text{C}$, $V_I = 35\text{ V}$)	I_{OS}	–	350	–	mA
Average Temperature Coefficient of Output Voltage ($I_O = 5.0\text{ mA}$)	$\Delta V_O / \Delta T$	–	± 0.2	–	$\text{mV}/^\circ\text{C}$
Peak Output Current ($T_J = 25^\circ\text{C}$)	I_O	–	700	–	mA

3. $T_{\text{low}} = 0^\circ\text{C}$ for MC78MxxAC, C
 = -40°C for MC78MxxAB, B, NCV78MxxAB, B
 $T_{\text{high}} = +125^\circ\text{C}$ for MC78MxxAB, AC, B, C, NCV78MxxAB, B

MC78M00, MC78M00A, NCV78M00 Series

MC78M09C/B, NCV78M09B ELECTRICAL CHARACTERISTICS

($V_I = 15\text{ V}$, $I_O = 350\text{ mA}$, $T_J = T_{\text{low}}$ to T_{high} , $P_D \leq 5.0\text{ W}$, unless otherwise noted) (Note 4)

Characteristics	Symbol	Min	Typ	Max	Unit
Output Voltage ($T_J = 25^\circ\text{C}$)	V_O	8.64	9.0	9.45	Vdc
Output Voltage Variation ($11.5\text{ Vdc} \leq V_I \leq 23\text{ Vdc}$, $5.0\text{ mA} \leq I_O \leq 350\text{ mA}$)	V_O	8.55	–	9.45	Vdc
Line Regulation ($T_J = 25^\circ\text{C}$, $11.5\text{ Vdc} \leq V_I \leq 25\text{ Vdc}$, $I_O = 200\text{ mA}$)	Reg_{line}	–	6.0	50	mV
Load Regulation ($T_J = 25^\circ\text{C}$, $5.0\text{ mA} \leq I_O \leq 500\text{ mA}$) ($T_J = 25^\circ\text{C}$, $5.0\text{ mA} \leq I_O \leq 200\text{ mA}$)	Reg_{load}	–	25 10	180 90	mV
Input Bias Current ($T_J = 25^\circ\text{C}$)	I_{IB}	–	3.2	6.0	mA
Quiescent Current Change ($11.5\text{ Vdc} \leq V_I \leq 25\text{ Vdc}$, $I_O = 200\text{ mA}$) ($5.0\text{ mA} \leq I_O \leq 350\text{ mA}$)	ΔI_{IB}	–	–	0.8 0.5	mA
Output Noise Voltage ($T_A = 25^\circ\text{C}$, $10\text{ Hz} \leq f \leq 100\text{ kHz}$)	V_n	–	52	–	μV
Ripple Rejection ($I_O = 100\text{ mA}$, $f = 120\text{ Hz}$, $12.5\text{ V} \leq V_I \leq 22.5\text{ V}$) ($I_O = 300\text{ mA}$, $f = 120\text{ Hz}$, $12.5\text{ V} \leq V_I \leq 22.5\text{ V}$, $T_J = 25^\circ\text{C}$)	RR	56 56	– 80	– –	dB
Dropout Voltage ($T_J = 25^\circ\text{C}$)	$V_I - V_O$	–	2.0	–	Vdc
Short Circuit Current Limit ($T_J = 25^\circ\text{C}$, $V_I = 35\text{ V}$)	I_{OS}	–	350	–	mA
Average Temperature Coefficient of Output Voltage ($I_O = 5.0\text{ mA}$)	$\Delta V_O / \Delta T$	–	± 0.2	–	$\text{mV}/^\circ\text{C}$
Peak Output Current ($T_J = 25^\circ\text{C}$)	I_O	–	700	–	mA

MC78M12C/AC/B/AB, NCV78M12B ELECTRICAL CHARACTERISTICS

($V_I = 19\text{ V}$, $I_O = 350\text{ mA}$, $T_J = T_{\text{low}}$ to T_{high} , $P_D \leq 5\text{ W}$, unless otherwise noted) (Note 4)

Characteristics	Symbol	Min	Typ	Max	Unit
Output Voltage ($T_J = 25^\circ\text{C}$) MC78M12B/MC78M12C/NCV78M12B MC78M12AB/MC78M12AC	V_O	11.50 11.76	12 12	12.50 12.24	Vdc
Output Voltage Variation ($14.5\text{ Vdc} \leq V_I \leq 27\text{ Vdc}$, $5.0\text{ mA} \leq I_O \leq 350\text{ mA}$) MC78M12B/MC78M12C/NCV78M12B MC78M12AB/MC78M12AC	V_O	11.4 11.5	– –	12.6 12.5	Vdc
Line Regulation ($T_J = 25^\circ\text{C}$, $14.5\text{ Vdc} \leq V_I \leq 30\text{ Vdc}$, $I_O = 200\text{ mA}$)	Reg_{line}	–	8.0	50	mV
Load Regulation ($T_J = 25^\circ\text{C}$, $5.0\text{ mA} \leq I_O \leq 500\text{ mA}$) ($T_J = 25^\circ\text{C}$, $5.0\text{ mA} \leq I_O \leq 200\text{ mA}$)	Reg_{load}	–	25 10	240 120	mV
Input Bias Current ($T_J = 25^\circ\text{C}$)	I_{IB}	–	3.2	6.0	mA
Quiescent Current Change ($14.5\text{ Vdc} \leq V_I \leq 30\text{ Vdc}$, $I_O = 200\text{ mA}$) ($5.0\text{ mA} \leq I_O \leq 350\text{ mA}$)	ΔI_{IB}	–	–	0.8 0.5	mA
Output Noise Voltage ($T_A = 25^\circ\text{C}$, $10\text{ Hz} \leq f \leq 100\text{ kHz}$)	V_n	–	75	–	μV
Ripple Rejection ($I_O = 100\text{ mA}$, $f = 120\text{ Hz}$, $15\text{ V} \leq V_I \leq 25\text{ V}$) ($I_O = 300\text{ mA}$, $f = 120\text{ Hz}$, $15\text{ V} \leq V_I \leq 25\text{ V}$, $T_J = 25^\circ\text{C}$)	RR	55 55	– 80	– –	dB
Dropout Voltage ($T_J = 25^\circ\text{C}$)	$V_I - V_O$	–	2.0	–	Vdc
Short Circuit Current Limit ($T_J = 25^\circ\text{C}$, $V_I = 35\text{ V}$)	I_{OS}	–	350	–	mA
Average Temperature Coefficient of Output Voltage ($I_O = 5.0\text{ mA}$)	$\Delta V_O / \Delta T$	–	± 0.3	–	$\text{mV}/^\circ\text{C}$
Peak Output Current ($T_J = 25^\circ\text{C}$)	I_O	–	700	–	mA

4. $T_{\text{low}} = 0^\circ\text{C}$ for MC78MxxAC, C
 = -40°C for MC78MxxAB, B, NCV78MxxAB, B
 $T_{\text{high}} = +125^\circ\text{C}$ for MC78MxxAB, AC, B, C, NCV78MxxAB, B

MC78M00, MC78M00A, NCV78M00 Series

MC78M15C/AC/B/AB, NCV78M15B ELECTRICAL CHARACTERISTICS

($V_I = 23\text{ V}$, $I_O = 350\text{ mA}$, $T_J = T_{\text{low}}$ to T_{high} , $P_D \leq 5\text{ W}$, unless otherwise noted) (Note 5)

Characteristics	Symbol	Min	Typ	Max	Unit
Output Voltage ($T_J = 25^\circ\text{C}$) MC78M15B/MC78M15C/NCV78M15B MC78M15AB/MC78M15AC	V_O	14.4 14.7	15 15	15.6 15.3	Vdc
Output Voltage Variation ($17.5\text{ Vdc} \leq V_I \leq 30\text{ Vdc}$, $5.0\text{ mA} \leq I_O \leq 350\text{ mA}$) MC78M15B/MC78M15C/NCV78M15B MC78M15AB/MC78M15AC	V_O	14.25 14.40	– –	15.75 15.60	Vdc
Input Regulation ($T_J = 25^\circ\text{C}$, $17.5\text{ Vdc} \leq V_I \leq 30\text{ Vdc}$, $I_O = 200\text{ mA}$)	Reg_{line}	–	10	50	mV
Load Regulation ($T_J = 25^\circ\text{C}$, $5.0\text{ mA} \leq I_O \leq 500\text{ mA}$) ($T_J = 25^\circ\text{C}$, $5.0\text{ mA} \leq I_O \leq 200\text{ mA}$)	Reg_{load}	– –	25 10	300 150	mV
Input Bias Current ($T_J = 25^\circ\text{C}$)	I_{IB}	–	3.2	6.0	mA
Quiescent Current Change ($17.5\text{ Vdc} \leq V_I \leq 30\text{ Vdc}$, $I_O = 200\text{ mA}$) ($5.0\text{ mA} \leq I_O \leq 350\text{ mA}$)	ΔI_{IB}	– –	– –	0.8 0.5	mA
Output Noise Voltage ($T_A = 25^\circ\text{C}$, $10\text{ Hz} \leq f \leq 100\text{ kHz}$)	V_n	–	90	–	μV
Ripple Rejection ($I_O = 100\text{ mA}$, $f = 120\text{ Hz}$, $18.5\text{ V} \leq V_I \leq 28.5\text{ V}$) ($I_O = 300\text{ mA}$, $f = 120\text{ Hz}$, $18.5\text{ V} \leq V_I \leq 28.5\text{ V}$, $T_J = 25^\circ\text{C}$)	RR	54 54	– 70	– –	dB
Dropout Voltage ($T_J = 25^\circ\text{C}$)	$V_I - V_O$	–	2.0	–	Vdc
Short Circuit Current Limit ($T_J = 25^\circ\text{C}$, $V_I = 35\text{ V}$)	I_{OS}	–	350	–	mA
Average Temperature Coefficient of Output Voltage ($I_O = 5.0\text{ mA}$)	$\Delta V_O / \Delta T$	–	± 0.3	–	$\text{mV}/^\circ\text{C}$
Peak Output Current ($T_J = 25^\circ\text{C}$)	I_O	–	700	–	mA

MC78M18C/B ELECTRICAL CHARACTERISTICS

($V_I = 27\text{ V}$, $I_O = 350\text{ mA}$, $T_J = T_{\text{low}}$ to T_{high} , $P_D \leq 5\text{ W}$, unless otherwise noted) (Note 5)

Characteristics	Symbol	Min	Typ	Max	Unit
Output Voltage ($T_J = 25^\circ\text{C}$)	V_O	17.3	18	18.7	Vdc
Output Voltage Variation ($21\text{ Vdc} \leq V_I \leq 33\text{ Vdc}$, $5.0\text{ mA} \leq I_O \leq 350\text{ mA}$)	V_O	17.1	–	18.9	Vdc
Line Regulation ($T_J = 25^\circ\text{C}$, $21\text{ Vdc} \leq V_I \leq 33\text{ Vdc}$, $I_O = 200\text{ mA}$)	Reg_{line}	–	10	50	mV
Load Regulation ($T_J = 25^\circ\text{C}$, $5.0\text{ mA} \leq I_O \leq 500\text{ mA}$) ($T_J = 25^\circ\text{C}$, $5.0\text{ mA} \leq I_O \leq 200\text{ mA}$)	Reg_{load}	– –	30 10	360 180	mV
Input Bias Current ($T_J = 25^\circ\text{C}$)	I_{IB}	–	3.2	6.5	mA
Quiescent Current Change ($21\text{ Vdc} \leq V_I \leq 33\text{ Vdc}$, $I_O = 200\text{ mA}$) ($5.0\text{ mA} \leq I_O \leq 350\text{ mA}$)	ΔI_{IB}	– –	– –	0.8 0.5	mA
Output Noise Voltage ($T_A = 25^\circ\text{C}$, $10\text{ Hz} \leq f \leq 100\text{ kHz}$)	V_n	–	100	–	μV
Ripple Rejection ($I_O = 100\text{ mA}$, $f = 120\text{ Hz}$, $22\text{ V} \leq V_I \leq 32\text{ V}$) ($I_O = 300\text{ mA}$, $f = 120\text{ Hz}$, $22\text{ V} \leq V_I \leq 32\text{ V}$, $T_J = 25^\circ\text{C}$)	RR	53 53	– 70	– –	dB
Dropout Voltage ($T_J = 25^\circ\text{C}$)	$V_I - V_O$	–	2.0	–	Vdc
Short Circuit Current Limit ($T_J = 25^\circ\text{C}$, $V_I = 35\text{ V}$)	I_{OS}	–	350	–	mA
Average Temperature Coefficient of Output Voltage ($I_O = 5.0\text{ mA}$)	$\Delta V_O / \Delta T$	–	± 0.3	–	$\text{mV}/^\circ\text{C}$
Peak Output Current ($T_J = 25^\circ\text{C}$)	I_O	–	700	–	mA

5. $T_{\text{low}} = 0^\circ\text{C}$ for MC78MxxAC, C
 = -40°C for MC78MxxAB, B, NCV78MxxAB, B
 $T_{\text{high}} = +125^\circ\text{C}$ for MC78MxxAB, AC, B, C, NCV78MxxAB, B

MC78M00, MC78M00A, NCV78M00 Series

MC78M20C/B ELECTRICAL CHARACTERISTICS

($V_I = 29\text{ V}$, $I_O = 350\text{ mA}$, $T_J = T_{\text{low}}$ to T_{high} , $P_D \leq 5.0\text{ W}$, unless otherwise noted) (Note 6)

Characteristics	Symbol	Min	Typ	Max	Unit
Output Voltage ($T_J = 25^\circ\text{C}$)	V_O	19.2	20	20.8	Vdc
Output Voltage Variation ($23\text{ Vdc} \leq V_I \leq 35\text{ Vdc}$, $5.0\text{ mA} \leq I_O \leq 350\text{ mA}$)	V_O	19	–	21	Vdc
Line Regulation ($T_J = 25^\circ\text{C}$, $23\text{ Vdc} \leq V_I \leq 35\text{ Vdc}$, $I_O = 200\text{ mA}$)	Reg_{line}	–	10	50	mV
Load Regulation ($T_J = 25^\circ\text{C}$, $5.0\text{ mA} \leq I_O \leq 500\text{ mA}$) ($T_J = 25^\circ\text{C}$, $5.0\text{ mA} \leq I_O \leq 200\text{ mA}$)	Reg_{load}	–	30 10	400 200	mV
Input Bias Current ($T_J = 25^\circ\text{C}$)	I_{IB}	–	3.2	6.5	mA
Quiescent Current Change ($23\text{ Vdc} \leq V_I \leq 35\text{ Vdc}$, $I_O = 200\text{ mA}$) ($5.0\text{ mA} \leq I_O \leq 350\text{ mA}$)	ΔI_{IB}	–	–	0.8 0.5	mA
Output Noise Voltage ($T_A = 25^\circ\text{C}$, $10\text{ Hz} \leq f \leq 100\text{ kHz}$)	V_n	–	110	–	μV
Ripple Rejection ($I_O = 100\text{ mA}$, $f = 120\text{ Hz}$, $24\text{ V} \leq V_I \leq 34\text{ V}$) ($I_O = 300\text{ mA}$, $f = 120\text{ Hz}$, $24\text{ V} \leq V_I \leq 34\text{ V}$, $T_J = 25^\circ\text{C}$)	RR	52 52	– 70	– –	dB
Dropout Voltage ($T_J = 25^\circ\text{C}$)	$V_I - V_O$	–	2.0	–	Vdc
Short Circuit Current Limit ($T_J = 25^\circ\text{C}$, $V_I = 35\text{ V}$)	I_{OS}	–	350	–	mA
Average Temperature Coefficient of Output Voltage ($I_O = 5.0\text{ mA}$)	$\Delta V_O / \Delta T$	–	± 0.5	–	$\text{mV}/^\circ\text{C}$
Peak Output Current ($T_J = 25^\circ\text{C}$)	I_O	–	700	–	mA

MC78M24C/B ELECTRICAL CHARACTERISTICS

($V_I = 33\text{ V}$, $I_O = 350\text{ mA}$, $T_J = T_{\text{low}}$ to T_{high} , $P_D \leq 5.0\text{ W}$, unless otherwise noted) (Note 6)

Characteristics	Symbol	Min	Typ	Max	Unit
Output Voltage ($T_J = 25^\circ\text{C}$)	V_O	23	24	25	Vdc
Output Voltage Variation ($27\text{ Vdc} \leq V_I \leq 38\text{ Vdc}$, $5.0\text{ mA} \leq I_O \leq 350\text{ mA}$)	V_O	22.8	–	25.2	Vdc
Line Regulation ($T_J = 25^\circ\text{C}$, $27\text{ Vdc} \leq V_I \leq 38\text{ Vdc}$, $I_O = 200\text{ mA}$)	Reg_{line}	–	10	50	mV
Load Regulation ($T_J = 25^\circ\text{C}$, $5.0\text{ mA} \leq I_O \leq 500\text{ mA}$) ($T_J = 25^\circ\text{C}$, $5.0\text{ mA} \leq I_O \leq 200\text{ mA}$)	Reg_{load}	–	30 10	480 240	mV
Input Bias Current ($T_J = 25^\circ\text{C}$)	I_{IB}	–	3.2	7.0	mA
Quiescent Current Change ($27\text{ Vdc} \leq V_I \leq 38\text{ Vdc}$, $I_O = 200\text{ mA}$) ($5.0\text{ mA} \leq I_O \leq 350\text{ mA}$)	ΔI_{IB}	–	–	0.8 0.5	mA
Output Noise Voltage ($T_A = 25^\circ\text{C}$, $10\text{ Hz} \leq f \leq 100\text{ kHz}$)	V_n	–	170	–	μV
Ripple Rejection ($I_O = 100\text{ mA}$, $f = 120\text{ Hz}$, $28\text{ V} \leq V_I \leq 38\text{ V}$) ($I_O = 300\text{ mA}$, $f = 120\text{ Hz}$, $28\text{ V} \leq V_I \leq 38\text{ V}$, $T_J = 25^\circ\text{C}$)	RR	50 50	– 70	– –	dB
Dropout Voltage ($T_J = 25^\circ\text{C}$)	$V_I - V_O$	–	2.0	–	Vdc
Short Circuit Current Limit ($T_J = 25^\circ\text{C}$)	I_{OS}	–	350	–	mA
Average Temperature Coefficient of Output Voltage ($I_O = 5.0\text{ mA}$)	$\Delta V_O / \Delta T$	–	± 0.5	–	$\text{mV}/^\circ\text{C}$
Peak Output Current ($T_J = 25^\circ\text{C}$)	I_O	–	700	–	mA

6. $T_{\text{low}} = 0^\circ\text{C}$ for MC78MxxAC, C
 $= -40^\circ\text{C}$ for MC78MxxAB, B
 $T_{\text{high}} = +125^\circ\text{C}$ for MC78MxxAB, AC, B, C

DEFINITIONS

Line Regulation – The change in output voltage for a change in the input voltage. The measurement is made under conditions of low dissipation or by using pulse techniques such that the average chip temperature is not significantly affected.

Load Regulation – The change in output voltage for a change in load current at constant chip temperature.

Maximum Power Dissipation – The maximum total device dissipation for which the regulator will operate within specifications.

Input Bias Current – That part of the input current that is not delivered to the load.

Output Noise Voltage – The rms AC voltage at the output, with constant load and no input ripple, measured over a specified frequency range.

Long Term Stability – Output voltage stability under accelerated life test conditions with the maximum rated voltage listed in the devices' electrical characteristics and maximum power dissipation.

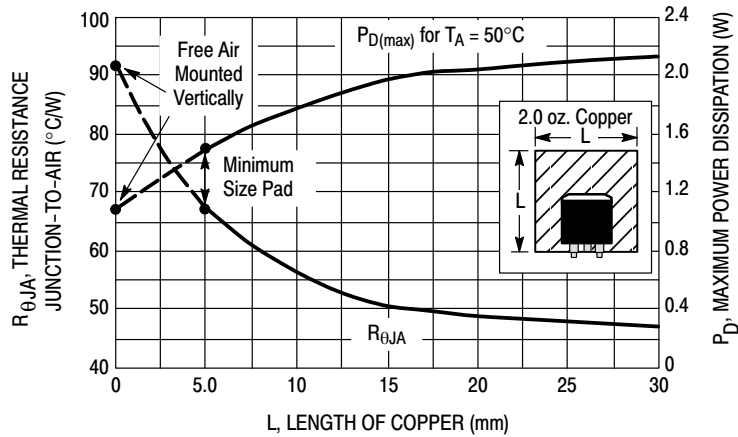

Figure 2. DPAK Thermal Resistance and Maximum Power Dissipation versus P.C.B. Copper Length



Figure 3. Worst Case Power Dissipation versus Ambient Temperature (TO-220)

MC78M00, MC78M00A, NCV78M00 Series

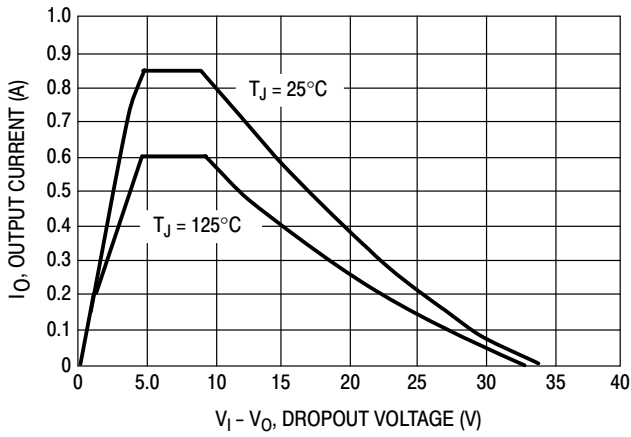

Figure 4. Peak Output Current versus Dropout Voltage

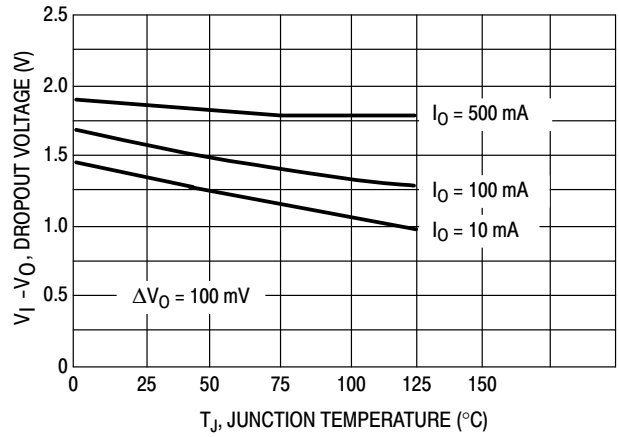

Figure 5. Dropout Voltage versus Junction Temperature

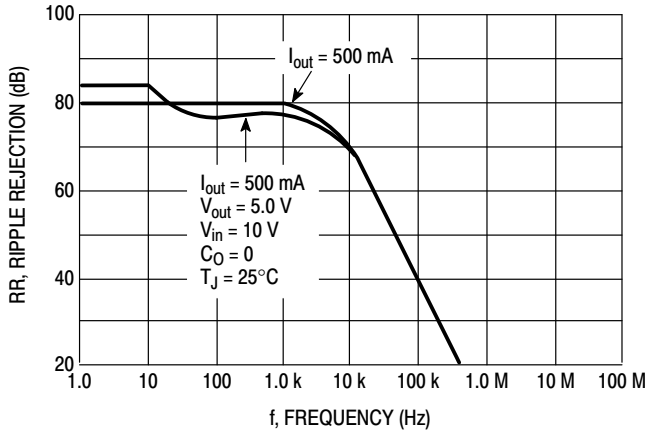

Figure 6. Ripple Rejection versus Frequency

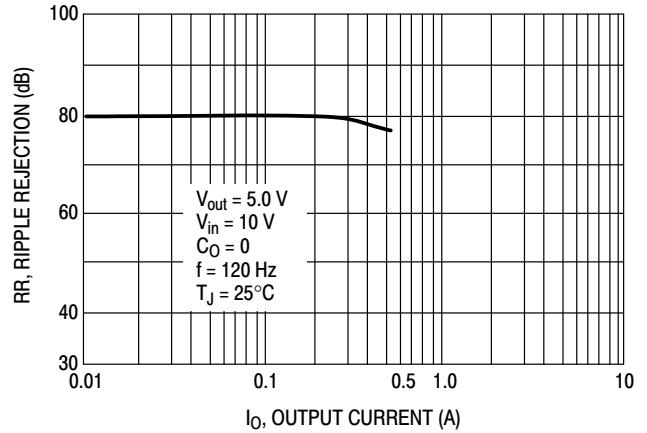

Figure 7. Ripple Rejection versus Output Current

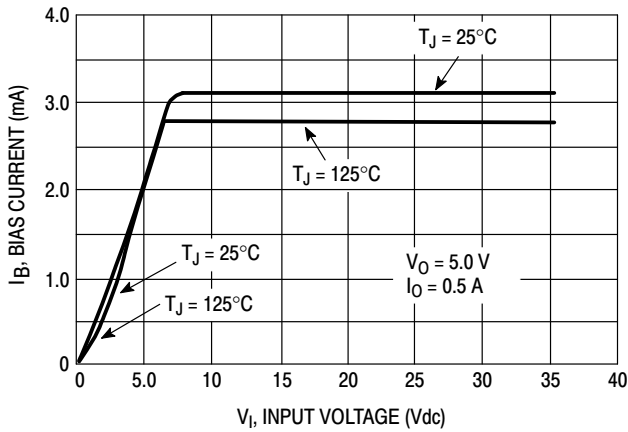

Figure 8. Bias Current versus Input Voltage

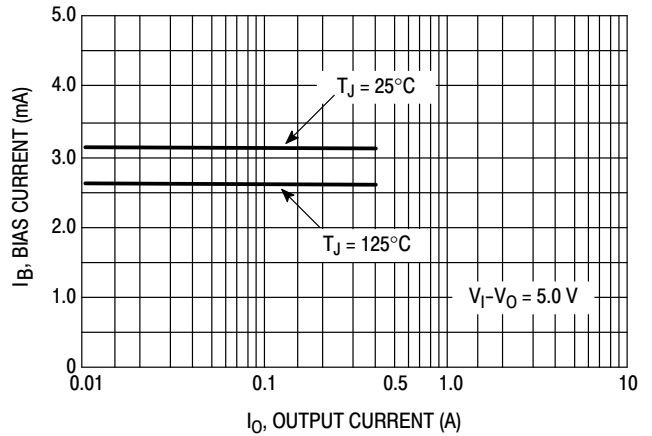

Figure 9. Bias Current versus Output Current

APPLICATIONS INFORMATION

Design Considerations

The MC78M00/MC78M00A Series of fixed voltage regulators are designed with Thermal Overload Protection that shuts down the circuit when subjected to an excessive power overload condition, Internal Short Circuit Protection that limits the maximum current the circuit will pass, and Output Transistor Safe-Area Compensation that reduces the output short circuit current as the voltage across the pass transistor is increased.

In many low current applications, compensation capacitors are not required. However, it is recommended that the regulator input be bypassed with a capacitor if the

regulator is connected to the power supply filter with long wire lengths, or if the output load capacitance is large. An input bypass capacitor should be selected to provide good high frequency characteristics to insure stable operation under all load conditions. A 0.33 μF or larger tantalum, mylar, or other capacitor having low internal impedance at high frequencies should be chosen. The bypass capacitor should be mounted with the shortest possible leads directly across the regulator's input terminals. Normally good construction techniques should be used to minimize ground loops and lead resistance drops since the regulator has no external sense lead.

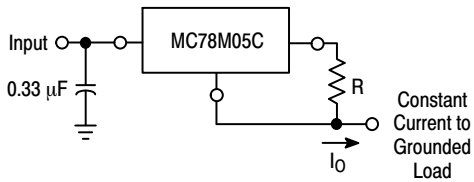

The MC78M00 regulators can also be used as a current source when connected as above. In order to minimize dissipation the MC78M05C is chosen in this application. Resistor R determines the current as follows:

$$I_o = \frac{5.0 \text{ V}}{R} + I_{IB}$$

$I_{IB} = 1.5 \text{ mA}$ over line and load changes.

For example, a 500 mA current source would require R to be a 10 Ω, 10 W resistor and the output voltage compliance would be the input voltage less 7.0 V.

Figure 10. Current Regulator



The addition of an operational amplifier allows adjustment to higher or intermediate values while retaining regulation characteristics. The minimum voltage obtainable with this arrangement is 2.0 V greater than the regulator voltage.

Figure 11. Adjustable Output Regulator



XX = 2 digits of type number indicating voltage.

The MC78M00 series can be current boosted with a PNP transistor. The MJ2955 provides current to 5.0 A. Resistor R in conjunction with the V_{BE} of the PNP determines when the pass transistor begins conducting; this circuit is not short circuit proof. Input-output differential voltage minimum is increased by V_{BE} of the pass transistor.

Figure 12. Current Boost Regulator

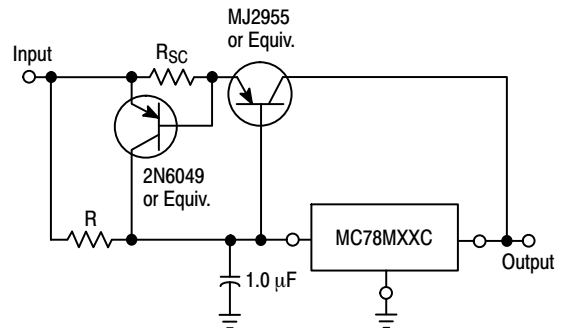

XX = 2 digits of type number indicating voltage.

The circuit of Figure 12 can be modified to provide supply protection against short circuits by adding a short circuit sense resistor, R_{sc} , and an additional PNP transistor. The current sensing PNP must be able to handle the short circuit current of the three-terminal regulator. Therefore, a 4.0 A plastic power transistor is specified.

Figure 13. Current Boost with Short Circuit Protection

MC78M00, MC78M00A, NCV78M00 Series

ORDERING INFORMATION

Device	Output Voltage	Temperature Range	Package	Marking	Shipping [†]
MC78M05CDTG	5.0 V	T _J = 0° to +125°C	DPAK-3 (Pb-Free)	78M05	75 Units / Rail
MC78M05CDTT5G	5.0 V	T _J = 0° to +125°C	DPAK-3 (Pb-Free)	78M05	2500 / Tape & Reel
MC78M05CDTRKG	5.0 V	T _J = 0° to +125°C	DPAK-3 (Pb-Free)	78M05	2500 / Tape & Reel
MC78M05ACDTG	5.0 V	T _J = 0° to +125°C	DPAK-3 (Pb-Free)	8M05D	75 Units / Rail
MC78M05ACDTRKG	5.0 V	T _J = 0° to +125°C	DPAK-3 (Pb-Free)	8M05D	2500 / Tape & Reel
MC78M05CTG	5.0 V	T _J = 0° to +125°C	TO-220 (Pb-Free)	78M05CT	50 Units / Rail
MC78M05ACTG	5.0 V	T _J = 0° to +125°C	TO-220 (Pb-Free)	78M05ACT	50 Units / Rail
MC78M05ABDTG	5.0 V	T _J = -40° to +125°C	DPAK-3 (Pb-Free)	8M05A	75 Units / Rail
MC78M05ABDTRKG	5.0 V	T _J = -40° to +125°C	DPAK-3 (Pb-Free)	8M05A	2500 / Tape & Reel
NCV78M05ABDTRKG*	5.0 V	T _J = -40° to +125°C	DPAK-3 (Pb-Free)	8M05A	2500 / Tape & Reel
MC78M05ABTG	5.0 V	T _J = -40° to +125°C	TO-220 (Pb-Free)	78M05ABT	50 Units / Rail
MC78M05BDTG	5.0 V	T _J = -40° to +125°C	DPAK-3 (Pb-Free)	8M05B	75 Units / Rail
MC78M05BDTT5G	5.0 V	T _J = -40° to +125°C	DPAK-3 (Pb-Free)	8M05B	2500 / Tape & Reel
MC78M05BDTRKG	5.0 V	T _J = -40° to +125°C	DPAK-3 (Pb-Free)	8M05B	2500 / Tape & Reel
NCV78M05BDTRKG*	5.0 V	T _J = -40° to +125°C	DPAK-3 (Pb-Free)	8M05B	2500 / Tape & Reel
MC78M05BTG	5.0 V	T _J = -40° to +125°C	TO-220 (Pb-Free)	78M05BT	50 Units / Rail
NCV78M05BTG*	5.0 V	T _J = -40° to +125°C	TO-220 (Pb-Free)	78M05BT	50 Units / Rail
MC78M06CDTG	6.0 V	T _J = 0° to +125°C	DPAK-3 (Pb-Free)	78M06	75 Units / Rail
MC78M06CDTRKG	6.0 V	T _J = 0° to +125°C	DPAK-3 (Pb-Free)	78M06	2500 / Tape & Reel
MC78M06CTG	6.0 V	T _J = 0° to +125°C	TO-220 (Pb-Free)	78M06CT	50 Units / Rail
MC78M06BTG	6.0 V	T _J = -40° to +125°C	TO-220 (Pb-Free)	78M06BT	50 Units / Rail
MC78M06BDTRKG	6.0 V	T _J = -40° to +125°C	DPAK-3 (Pb-Free)	8M06B	2500 / Tape & Reel
MC78M08CDTG	8.0 V	T _J = 0° to +125°C	DPAK-3 (Pb-Free)	78M08	75 Units / Rail

[†]For information on tape and reel specifications, including part orientation and tape sizes, please refer to our Tape and Reel Packaging Specifications Brochure, BRD8011/D.

*NCV devices: T_{low} = -40°C, T_{high} = +125°C. Guaranteed by design. NCV Prefix for Automotive and Other Applications Requiring Unique Site and Control Change Requirements; AEC-Q100 Qualified and PPAP Capable.

MC78M00, MC78M00A, NCV78M00 Series

ORDERING INFORMATION (continued)

Device	Output Voltage	Temperature Range	Package	Marking	Shipping [†]
MC78M08CDTRKG	8.0 V	T _J = 0° to +125°C	DPAK-3 (Pb-Free)	78M08	2500 Units / Tape & Reel
MC78M08ACDTG	8.0 V	T _J = 0° to +125°C	DPAK-3 (Pb-Free)	8M08D	75 Units / Rail
MC78M08ACDTRKG	8.0 V	T _J = 0° to +125°C	DPAK-3 (Pb-Free)	8M08D	2500 Units / Tape & Reel
MC78M08CTG	8.0 V	T _J = 0° to +125°C	TO-220 (Pb-Free)	78M08CT	50 Units / Rail
MC78M08ACTG	8.0 V	T _J = 0° to +125°C	TO-220 (Pb-Free)	78M08ACT	50 Units / Rail
MC78M08ABDTG	8.0 V	T _J = -40° to +125°C	DPAK-3 (Pb-Free)	8M08A	75 Units / Rail
MC78M08ABDTRKG	8.0 V	T _J = -40° to +125°C	DPAK-3 (Pb-Free)	8M08A	2500 Units / Tape & Reel
MC78M08ABTG	8.0 V	T _J = -40° to +125°C	TO-220 (Pb-Free)	78M08ABT	50 Units / Rail
MC78M08BDTG	8.0 V	T _J = -40° to +125°C	DPAK-3 (Pb-Free)	8M08B	75 Units / Rail
MC78M08BDTRKG	8.0 V	T _J = -40° to +125°C	DPAK-3 (Pb-Free)	8M08B	2500 Units / Tape & Reel
NCV78M08BDTRKG*	8.0 V	T _J = -40° to +125°C	DPAK-3 (Pb-Free)	8M08B	2500 Units / Tape & Reel
MC78M08BTG	8.0 V	T _J = -40° to +125°C	TO-220 (Pb-Free)	78M08BT	50 Units / Rail
MC78M09CDTG	9.0 V	T _J = 0° to +125°C	DPAK-3 (Pb-Free)	78M09	75 Units / Rail
MC78M09CDTRKG	9.0 V	T _J = 0° to +125°C	DPAK-3 (Pb-Free)	78M09	2500 Units / Tape & Reel
MC78M09CTG	9.0 V	T _J = 0° to +125°C	TO-220 (Pb-Free)	78M09CT	50 Units / Rail
MC78M09BDTG	9.0 V	T _J = -40° to +125°C	DPAK-3 (Pb-Free)	8M09B	75 Units / Rail
MC78M09BDTRKG	9.0 V	T _J = -40° to +125°C	DPAK-3 (Pb-Free)	8M09B	2500 Units / Tape & Reel
NCV78M09BDTRKG*	9.0 V	T _J = -40° to +125°C	DPAK-3 (Pb-Free)	8M09B	2500 Units / Tape & Reel
MC78M12CDTG	12 V	T _J = 0° to +125°C	DPAK-3 (Pb-Free)	78M12	75 Units / Rail
MC78M12CDTT5G	12 V	T _J = 0° to +125°C	DPAK-3 (Pb-Free)	78M12	2500 Units / Tape & Reel
MC78M12CDTRKG	12 V	T _J = 0° to +125°C	DPAK-3 (Pb-Free)	78M12	2500 Units / Tape & Reel
MC78M12ACDTG	12 V	T _J = 0° to +125°C	DPAK-3 (Pb-Free)	8M12D	75 Units / Rail
MC78M12ACDTRKG	12 V	T _J = 0° to +125°C	DPAK-3 (Pb-Free)	8M12D	2500 Units / Tape & Reel

[†]For information on tape and reel specifications, including part orientation and tape sizes, please refer to our Tape and Reel Packaging Specifications Brochure, BRD8011/D.

*NCV devices: T_{low} = -40°C, T_{high} = +125°C. Guaranteed by design. NCV Prefix for Automotive and Other Applications Requiring Unique Site and Control Change Requirements; AEC-Q100 Qualified and PPAP Capable.

MC78M00, MC78M00A, NCV78M00 Series

ORDERING INFORMATION (continued)

Device	Output Voltage	Temperature Range	Package	Marking	Shipping [†]
MC78M12CTG	12 V	T _J = 0° to +125°C	TO-220 (Pb-Free)	78M12CT	50 Units / Rail
MC78M12ACTG	12 V	T _J = 0° to +125°C	TO-220 (Pb-Free)	78M12ACT	50 Units / Rail
MC78M12ABDTG	12 V	T _J = -40° to +125°C	DPAK-3 (Pb-Free)	8M12A	75 Units / Rail
MC78M12ABDTRKG	12 V	T _J = -40° to +125°C	DPAK-3 (Pb-Free)	8M12A	2500 Units / Tape & Reel
MC78M12ABTG	12 V	T _J = -40° to +125°C	TO-220 (Pb-Free)	78M12ABT	50 Units / Rail
MC78M12BDTG	12 V	T _J = -40° to +125°C	DPAK-3 (Pb-Free)	8M12B	75 Units / Rail
MC78M12BDTRKG	12 V	T _J = -40° to +125°C	DPAK-3 (Pb-Free)	8M12B	2500 Units / Tape & Reel
NCV78M12BDTRKG*	12 V	T _J = -40° to +125°C	DPAK-3 (Pb-Free)	8M12B	2500 Units / Tape & Reel
MC78M12BTG	12 V	T _J = -40° to +125°C	TO-220 (Pb-Free)	78M12BT	50 Units / Rail
MC78M15CDTG	15 V	T _J = 0° to +125°C	DPAK-3 (Pb-Free)	78M15	75 Units / Rail
MC78M15CDTT5G	15 V	T _J = 0° to +125°C	DPAK-3 (Pb-Free)	78M15	2500 Units / Tape & Reel
MC78M15CDTRKG	15 V	T _J = 0° to +125°C	DPAK-3 (Pb-Free)	78M15	2500 Units / Tape & Reel
MC78M15ACDTG	15 V	T _J = 0° to +125°C	DPAK-3 (Pb-Free)	8M15D	75 Units / Rail
MC78M15ACDTRKG	15 V	T _J = 0° to +125°C	DPAK-3 (Pb-Free)	8M15D	2500 Units / Tape & Reel
MC78M15CTG	15 V	T _J = 0° to +125°C	TO-220 (Pb-Free)	78M15CT	50 Units / Rail
MC78M15ACTG	15 V	T _J = 0° to +125°C	TO-220 (Pb-Free)	78M15ACT	50 Units / Rail
MC78M15ABDTG	15 V	T _J = -40° to +125°C	DPAK-3 (Pb-Free)	8M15A	75 Units / Rail
MC78M15ABDTRKG	15 V	T _J = -40° to +125°C	DPAK-3 (Pb-Free)	8M15A	2500 Units / Tape & Reel
MC78M15ABTG	15 V	T _J = -40° to +125°C	TO-220 (Pb-Free)	78M15ABT	50 Units / Rail
MC78M15BDTG	15 V	T _J = -40° to +125°C	DPAK-3 (Pb-Free)	8M15B	75 Units / Rail
NCV78M15BDTG*	15 V	T _J = -40° to +125°C	DPAK-3 (Pb-Free)	8M15B	75 Units / Rail
MC78M15BDTRKG	15 V	T _J = -40° to +125°C	DPAK-3 (Pb-Free)	8M15B	2500 Units / Tape & Reel
NCV78M15BDTRKG*	15 V	T _J = -40° to +125°C	DPAK-3 (Pb-Free)	8M15B	2500 Units / Tape & Reel

[†]For information on tape and reel specifications, including part orientation and tape sizes, please refer to our Tape and Reel Packaging Specifications Brochure, BRD8011/D.

*NCV devices: T_{low} = -40°C, T_{high} = +125°C. Guaranteed by design. NCV Prefix for Automotive and Other Applications Requiring Unique Site and Control Change Requirements; AEC-Q100 Qualified and PPAP Capable.

MC78M00, MC78M00A, NCV78M00 Series

ORDERING INFORMATION (continued)

Device	Output Voltage	Temperature Range	Package	Marking	Shipping [†]
MC78M15BTG	15 V	$T_J = -40^\circ$ to $+125^\circ\text{C}$	TO-220 (Pb-Free)	78M15BT	50 Units / Rail
MC78M18CDTG	18 V	$T_J = 0^\circ$ to $+125^\circ\text{C}$	DPAK-3 (Pb-Free)	78M18	75 Units / Rail
MC78M18CDTRKG	18 V	$T_J = 0^\circ$ to $+125^\circ\text{C}$	DPAK-3 (Pb-Free)	78M18	2500 Units / Tape & Reel
MC78M18CTG	18 V	$T_J = 0^\circ$ to $+125^\circ\text{C}$	TO-220 (Pb-Free)	78M18CT	50 Units / Rail
MC78M18BTG	18 V	$T_J = -40^\circ$ to $+125^\circ\text{C}$	TO-220 (Pb-Free)	78M18BT	50 Units / Rail
MC78M20CTG	20 V	$T_J = 0^\circ$ to $+125^\circ\text{C}$	TO-220 (Pb-Free)	78M20CT	50 Units / Rail
MC78M24CTG	24 V	$T_J = 0^\circ$ to $+125^\circ\text{C}$	TO-220 (Pb-Free)	78M24CT	50 Units / Rail
MC78M24BTG	24 V	$T_J = -40^\circ$ to $+125^\circ\text{C}$	TO-220 (Pb-Free)	78M24BT	50 Units / Rail

[†]For information on tape and reel specifications, including part orientation and tape sizes, please refer to our Tape and Reel Packaging Specifications Brochure, BRD8011/D.

*NCV devices: $T_{\text{low}} = -40^\circ\text{C}$, $T_{\text{high}} = +125^\circ\text{C}$. Guaranteed by design. NCV Prefix for Automotive and Other Applications Requiring Unique Site and Control Change Requirements; AEC-Q100 Qualified and PPAP Capable.

MECHANICAL CASE OUTLINE

PACKAGE DIMENSIONS

ON Semiconductor®



TO-220, SINGLE GAUGE CASE 221AB-01 ISSUE A

DATE 16 NOV 2010



SCALE 1:1

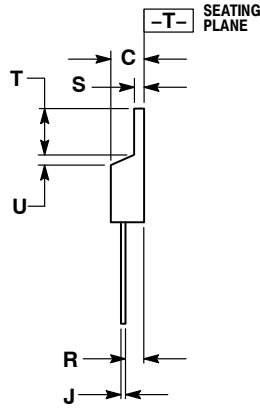

NOTES:

1. DIMENSIONING AND TOLERANCING PER ANSI Y14.5M, 1982.
2. CONTROLLING DIMENSION: INCHES.
3. DIMENSION Z DEFINES A ZONE WHERE ALL BODY AND LEAD IRREGULARITIES ARE ALLOWED.
4. PRODUCT SHIPPED PRIOR TO 2008 HAD DIMENSIONS S = 0.045 - 0.055 INCHES (1.143 - 1.397 MM)

DIM	INCHES		MILLIMETERS	
	MIN	MAX	MIN	MAX
A	0.570	0.620	14.48	15.75
B	0.380	0.405	9.66	10.28
C	0.160	0.190	4.07	4.82
D	0.025	0.035	0.64	0.88
F	0.142	0.147	3.61	3.73
G	0.095	0.105	2.42	2.66
H	0.110	0.155	2.80	3.93
J	0.018	0.025	0.46	0.64
K	0.500	0.562	12.70	14.27
L	0.045	0.060	1.15	1.52
N	0.190	0.210	4.83	5.33
Q	0.100	0.120	2.54	3.04
R	0.080	0.110	2.04	2.79
S	0.020	0.024	0.508	0.61
T	0.235	0.255	5.97	6.47
U	0.000	0.050	0.00	1.27
V	0.045	---	1.15	---
Z	---	0.080	---	2.04

STYLE 1:

- PIN 1. BASE
2. COLLECTOR
3. EMITTER
4. COLLECTOR

STYLE 2:

- PIN 1. BASE
2. EMITTER
3. COLLECTOR
4. EMITTER

STYLE 3:

- PIN 1. CATHODE
2. ANODE
3. GATE
4. ANODE

STYLE 4:

- PIN 1. MAIN TERMINAL 1
2. MAIN TERMINAL 2
3. GATE
4. MAIN TERMINAL 2

STYLE 5:

- PIN 1. GATE
2. DRAIN
3. SOURCE
4. DRAIN

STYLE 6:

- PIN 1. ANODE
2. CATHODE
3. ANODE
4. CATHODE

STYLE 7:

- PIN 1. CATHODE
2. ANODE
3. CATHODE
4. ANODE

STYLE 8:

- PIN 1. CATHODE
2. ANODE
3. EXTERNAL TRIP/DELAY
4. ANODE

STYLE 9:

- PIN 1. GATE
2. COLLECTOR
3. EMITTER
4. COLLECTOR

STYLE 10:

- PIN 1. GATE
2. SOURCE
3. DRAIN
4. SOURCE

STYLE 11:

- PIN 1. DRAIN
2. SOURCE
3. GATE
4. SOURCE

DOCUMENT NUMBER:	98AON23085D	Electronic versions are uncontrolled except when accessed directly from the Document Repository. Printed versions are uncontrolled except when stamped "CONTROLLED COPY" in red.
DESCRIPTION:	TO-220, SINGLE GAUGE	PAGE 1 OF 1

ON Semiconductor and are trademarks of Semiconductor Components Industries, LLC dba ON Semiconductor or its subsidiaries in the United States and/or other countries. ON Semiconductor reserves the right to make changes without further notice to any products herein. ON Semiconductor makes no warranty, representation or guarantee regarding the suitability of its products for any particular purpose, nor does ON Semiconductor assume any liability arising out of the application or use of any product or circuit, and specifically disclaims any and all liability, including without limitation special, consequential or incidental damages. ON Semiconductor does not convey any license under its patent rights nor the rights of others.

MECHANICAL CASE OUTLINE

PACKAGE DIMENSIONS

ON Semiconductor®



SCALE 1:1

DPAK (SINGLE GAUGE) CASE 369C ISSUE F

DATE 21 JUL 2015



NOTES:

1. DIMENSIONING AND TOLERANCING PER ASME Y14.5M, 1994.
2. CONTROLLING DIMENSION: INCHES.
3. THERMAL PAD CONTOUR OPTIONAL WITHIN DIMENSIONS b3, L3 and Z.
4. DIMENSIONS D AND E DO NOT INCLUDE MOLD FLASH, PROTRUSIONS, OR BURRS. MOLD FLASH, PROTRUSIONS, OR GATE BURRS SHALL NOT EXCEED 0.006 INCHES PER SIDE.
5. DIMENSIONS D AND E ARE DETERMINED AT THE OUTERMOST EXTREMES OF THE PLASTIC BODY.
6. DATUMS A AND B ARE DETERMINED AT DATUM PLANE H.
7. OPTIONAL MOLD FEATURE.

DIM	INCHES		MILLIMETERS	
	MIN	MAX	MIN	MAX
A	0.086	0.094	2.18	2.38
A1	0.000	0.005	0.00	0.13
b	0.025	0.035	0.63	0.89
b2	0.028	0.045	0.72	1.14
b3	0.180	0.215	4.57	5.46
c	0.018	0.024	0.46	0.61
c2	0.018	0.024	0.46	0.61
D	0.235	0.245	5.97	6.22
E	0.250	0.265	6.35	6.73
e	0.090 BSC		2.29 BSC	
H	0.370	0.410	9.40	10.41
L	0.055	0.070	1.40	1.78
L1	0.114 REF		2.90 REF	
L2	0.020 BSC		0.51 BSC	
L3	0.035	0.050	0.89	1.27
L4	---	0.040	---	1.01
Z	0.155	---	3.93	---

GENERIC MARKING DIAGRAM*



- XXXXXX = Device Code
- A = Assembly Location
- L = Wafer Lot
- Y = Year
- WW = Work Week
- G = Pb-Free Package

*This information is generic. Please refer to device data sheet for actual part marking.

- | | | | | |
|--|--|---|---|--|
| <p>STYLE 1:
PIN 1. BASE
2. COLLECTOR
3. EMITTER
4. COLLECTOR</p> | <p>STYLE 2:
PIN 1. GATE
2. DRAIN
3. SOURCE
4. DRAIN</p> | <p>STYLE 3:
PIN 1. ANODE
2. CATHODE
3. ANODE
4. CATHODE</p> | <p>STYLE 4:
PIN 1. CATHODE
2. ANODE
3. GATE
4. ANODE</p> | <p>STYLE 5:
PIN 1. GATE
2. ANODE
3. CATHODE
4. ANODE</p> |
| <p>STYLE 6:
PIN 1. MT1
2. MT2
3. GATE
4. MT2</p> | <p>STYLE 7:
PIN 1. GATE
2. COLLECTOR
3. EMITTER
4. COLLECTOR</p> | <p>STYLE 8:
PIN 1. N/C
2. CATHODE
3. ANODE
4. CATHODE</p> | <p>STYLE 9:
PIN 1. ANODE
2. CATHODE
3. RESISTOR ADJUST
4. CATHODE</p> | <p>STYLE 10:
PIN 1. CATHODE
2. ANODE
3. CATHODE
4. ANODE</p> |

SOLDERING FOOTPRINT*

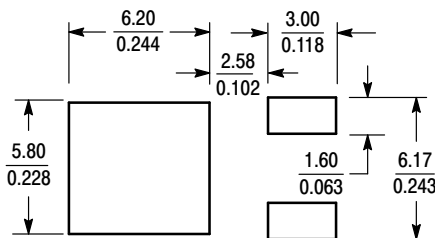

SCALE 3:1 (mm / inches)

*For additional information on our Pb-Free strategy and soldering details, please download the ON Semiconductor Soldering and Mounting Techniques Reference Manual, SOLDERRM/D.

DOCUMENT NUMBER:	98AON10527D	Electronic versions are uncontrolled except when accessed directly from the Document Repository. Printed versions are uncontrolled except when stamped "CONTROLLED COPY" in red.
DESCRIPTION:	DPAK (SINGLE GAUGE)	PAGE 1 OF 1

ON Semiconductor and ON are trademarks of Semiconductor Components Industries, LLC dba ON Semiconductor or its subsidiaries in the United States and/or other countries. ON Semiconductor reserves the right to make changes without further notice to any products herein. ON Semiconductor makes no warranty, representation or guarantee regarding the suitability of its products for any particular purpose, nor does ON Semiconductor assume any liability arising out of the application or use of any product or circuit, and specifically disclaims any and all liability, including without limitation special, consequential or incidental damages. ON Semiconductor does not convey any license under its patent rights nor the rights of others.

ON Semiconductor and  are trademarks of Semiconductor Components Industries, LLC dba ON Semiconductor or its subsidiaries in the United States and/or other countries. ON Semiconductor owns the rights to a number of patents, trademarks, copyrights, trade secrets, and other intellectual property. A listing of ON Semiconductor's product/patent coverage may be accessed at www.onsemi.com/site/pdf/Patent-Marking.pdf. ON Semiconductor reserves the right to make changes without further notice to any products herein. ON Semiconductor makes no warranty, representation or guarantee regarding the suitability of its products for any particular purpose, nor does ON Semiconductor assume any liability arising out of the application or use of any product or circuit, and specifically disclaims any and all liability, including without limitation special, consequential or incidental damages. Buyer is responsible for its products and applications using ON Semiconductor products, including compliance with all laws, regulations and safety requirements or standards, regardless of any support or applications information provided by ON Semiconductor. "Typical" parameters which may be provided in ON Semiconductor data sheets and/or specifications can and do vary in different applications and actual performance may vary over time. All operating parameters, including "Typicals" must be validated for each customer application by customer's technical experts. ON Semiconductor does not convey any license under its patent rights nor the rights of others. ON Semiconductor products are not designed, intended, or authorized for use as a critical component in life support systems or any FDA Class 3 medical devices or medical devices with a same or similar classification in a foreign jurisdiction or any devices intended for implantation in the human body. Should Buyer purchase or use ON Semiconductor products for any such unintended or unauthorized application, Buyer shall indemnify and hold ON Semiconductor and its officers, employees, subsidiaries, affiliates, and distributors harmless against all claims, costs, damages, and expenses, and reasonable attorney fees arising out of, directly or indirectly, any claim of personal injury or death associated with such unintended or unauthorized use, even if such claim alleges that ON Semiconductor was negligent regarding the design or manufacture of the part. ON Semiconductor is an Equal Opportunity/Affirmative Action Employer. This literature is subject to all applicable copyright laws and is not for resale in any manner.

PUBLICATION ORDERING INFORMATION

LITERATURE FULFILLMENT:

Email Requests to: orderlit@onsemi.com

ON Semiconductor Website: www.onsemi.com

TECHNICAL SUPPORT

North American Technical Support:
Voice Mail: 1 800-282-9855 Toll Free USA/Canada
Phone: 011 421 33 790 2910

Europe, Middle East and Africa Technical Support:

Phone: 00421 33 790 2910

For additional information, please contact your local Sales Representative