



Is Now Part of



ON Semiconductor®

To learn more about ON Semiconductor, please visit our website at
www.onsemi.com

Please note: As part of the Fairchild Semiconductor integration, some of the Fairchild orderable part numbers will need to change in order to meet ON Semiconductor's system requirements. Since the ON Semiconductor product management systems do not have the ability to manage part nomenclature that utilizes an underscore (_), the underscore (_) in the Fairchild part numbers will be changed to a dash (-). This document may contain device numbers with an underscore (_). Please check the ON Semiconductor website to verify the updated device numbers. The most current and up-to-date ordering information can be found at www.onsemi.com. Please email any questions regarding the system integration to Fairchild_questions@onsemi.com.

ON Semiconductor and the ON Semiconductor logo are trademarks of Semiconductor Components Industries, LLC dba ON Semiconductor or its subsidiaries in the United States and/or other countries. ON Semiconductor owns the rights to a number of patents, trademarks, copyrights, trade secrets, and other intellectual property. A listing of ON Semiconductor's product/patent coverage may be accessed at www.onsemi.com/site/pdf/Patent-Marking.pdf. ON Semiconductor reserves the right to make changes without further notice to any products herein. ON Semiconductor makes no warranty, representation or guarantee regarding the suitability of its products for any particular purpose, nor does ON Semiconductor assume any liability arising out of the application or use of any product or circuit, and specifically disclaims any and all liability, including without limitation special, consequential or incidental damages. Buyer is responsible for its products and applications using ON Semiconductor products, including compliance with all laws, regulations and safety requirements or standards, regardless of any support or applications information provided by ON Semiconductor. "Typical" parameters which may be provided in ON Semiconductor data sheets and/or specifications can and do vary in different applications and actual performance may vary over time. All operating parameters, including "Typicals" must be validated for each customer application by customer's technical experts. ON Semiconductor does not convey any license under its patent rights nor the rights of others. ON Semiconductor products are not designed, intended, or authorized for use as a critical component in life support systems or any FDA Class 3 medical devices or medical devices with a same or similar classification in a foreign jurisdiction or any devices intended for implantation in the human body. Should Buyer purchase or use ON Semiconductor products for any such unintended or unauthorized application, Buyer shall indemnify and hold ON Semiconductor and its officers, employees, subsidiaries, affiliates, and distributors harmless against all claims, costs, damages, and expenses, and reasonable attorney fees arising out of, directly or indirectly, any claim of personal injury or death associated with such unintended or unauthorized use, even if such claim alleges that ON Semiconductor was negligent regarding the design or manufacture of the part. ON Semiconductor is an Equal Opportunity/Affirmative Action Employer. This literature is subject to all applicable copyright laws and is not for resale in any manner.

74VHCT574A Octal D-Type Flip-Flop with 3-STATE Outputs

General Description

The VHCT574A is an advanced high speed CMOS octal flip-flop with 3-STATE output fabricated with silicon gate CMOS technology. It achieves the high speed operation similar to equivalent Bipolar Schottky TTL while maintaining the CMOS low power dissipation. This 8-bit D-type flip-flop is controlled by a clock input (CP) and an Output Enable input (OE). When the OE input is HIGH, the eight outputs are in a high impedance state.

Protection circuits ensure that 0V to 7V can be applied to the input and output (Note 1) pins without regard to the supply voltage. This device can be used to interface 3V to 5V systems and two supply systems such as battery back up. This circuit prevents device destruction due to mismatched supply and input voltages.

Note 1: Outputs in OFF-State.

Features

- High speed: $f_{MAX} = 140$ MHz (typ) at $T_A = 25^\circ\text{C}$
- Power Down Protection is provided on all inputs and outputs.
- Low Noise: $V_{OLP} = 1.6\text{V}$ (max)
- Low Power Dissipation:
 $I_{CC} = 4 \mu\text{A}$ (max) @ $T_A = 25^\circ\text{C}$
- Pin and Function Compatible with 74HCT574

Ordering Code:

| Order Number | Package Number | Package Description |
|---------------|----------------|---|
| 74VHCT574AM | M20B | 20-Lead Small Outline Integrated Circuit (SOIC), JEDEC MS-013, 0.300" Wide |
| 74VHCT574ASJ | M20D | Pb-Free 20-Lead Small Outline Package (SOP), EIAJ TYPE II, 5.3mm Wide |
| 74VHCT574AMTC | MTC20 | 20-Lead Thin Shrink Small Outline Package (TSSOP), JEDEC MO-153, 4.4mm Wide |
| 74VHCT574AN | N20A | 20-Lead Plastic Dual-In-Line Package (PDIP), JEDEC MS-001, 0.300" Wide |

Surface mount packages are also available on Tape and Reel. Specify by appending the suffix letter "X" to the ordering code.
Pb-Free package per JEDEC J-STD-020B.

Logic Symbol

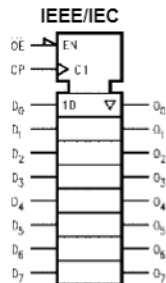

Connection Diagram

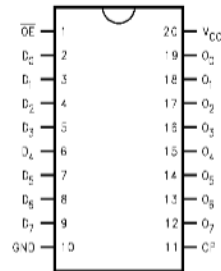

Pin Descriptions

| Pin Names | Description |
|--------------------------------|-----------------------------|
| D ₀ -D ₇ | Data Inputs |
| CP | Clock Pulse Input 3-STATE |
| \overline{OE} | Output Enable Input 3-STATE |
| O ₀ -O ₇ | Outputs |

Truth Table

| Inputs | | | Outputs |
|----------------|----|-----------------|----------------|
| D _n | CP | \overline{OE} | O _n |
| H | ↗ | L | H |
| L | ↗ | L | L |
| X | X | H | Z |

H = HIGH Voltage Level
 L = LOW Voltage Level
 X = Immaterial
 Z = High Impedance
 ↗ = LOW-to-HIGH Transition

Functional Description

The VHCT574A consists of eight edge-triggered flip-flops with individual D-type inputs and 3-STATE true outputs. The buffered clock and buffered Output Enable are common to all flip-flops. The eight flip-flops will store the state of their individual D inputs that meet the setup and hold time requirements on the LOW-to-HIGH Clock (CP) transi-

tion. With the Output Enable (\overline{OE}) LOW, the contents of the eight flip-flops are available at the outputs. When the \overline{OE} is HIGH, the outputs go to the high impedance state. Operation of the \overline{OE} input does not affect the state of the flip-flops.

Logic Diagram

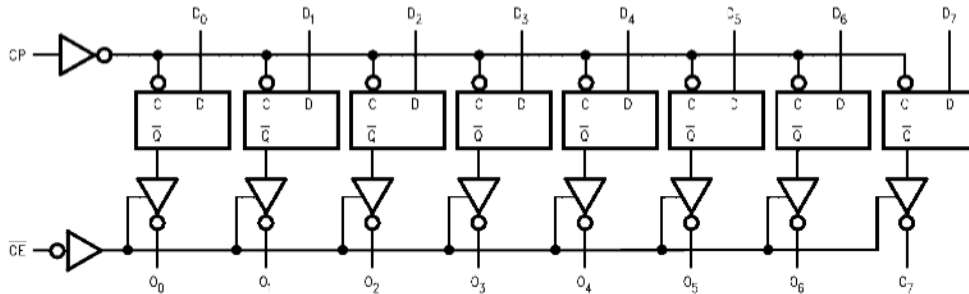

Please note that this diagram is provided only for the understanding of logic operations and should not be used to estimate propagation delays.

Absolute Maximum Ratings (Note 2)

| | |
|--|--------------------------|
| Supply Voltage (V_{CC}) | -0.5V to +7.0V |
| DC Input Voltage (V_{IN}) | -0.5V to +7.0V |
| DC Output Voltage (V_{OUT}) | -0.5V to $V_{CC} + 0.5V$ |
| (Note 3) | |
| (Note 4) | -0.5V to +7.0V |
| Input Diode Current (I_{IK}) | -20 mA |
| Output Diode Current (I_{OK}) (Note 5) | ± 20 mA |
| DC Output Current (I_{OUT}) | ± 25 mA |
| DC V_{CC}/GND Current (I_{CC}) | ± 75 mA |
| Storage Temperature (T_{STG}) | -65°C to +150°C |
| Lead Temperature (T_L) | 260°C |
| (Soldering, 10 seconds) | |

Recommended Operating Conditions (Note 6)

| | |
|---|------------------|
| Supply Voltage (V_{CC}) | 4.5V to +5.5V |
| Input Voltage (V_{IN}) | 0V to +5.5V |
| Output Voltage (V_{OUT}) | 0V to V_{CC} |
| (Note 3) | |
| (Note 4) | 0V to +5.5V |
| Operating Temperature (T_{OPR}) | -40°C to +85°C |
| Input Rise and Fall Time (t_r, t_f) | |
| $V_{CC} = 5.0V \pm 0.5V$ | 0 ns/V ~ 20 ns/V |

Note 2: Absolute Maximum Ratings are values beyond which the device may be damaged or have its useful life impaired. The databook specifications should be met, without exception, to ensure that the system design is reliable over its power supply, temperature, and output/input loading variables. Fairchild does not recommend operation outside databook specifications.

Note 3: HIGH or LOW state. I_{OUT} absolute maximum rating must be observed.

Note 4: When outputs are in OFF-State or when $V_{CC} = 0V$.

Note 5: $V_{OUT} < GND$, $V_{OUT} > V_{CC}$ (Outputs Active).

Note 6: Unused inputs must be held HIGH or LOW. They may not float.

DC Electrical Characteristics

| Symbol | Parameter | V_{CC} (V) | $T_A = 25^\circ C$ | | | $T_A = -40^\circ C$ to $+85^\circ C$ | | Units | Conditions |
|-----------|--|-----------------|--------------------|------------|-----|--------------------------------------|-----|---------|--|
| | | | Min | Typ | Max | Min | Max | | |
| V_{IH} | HIGH Level Input Voltage | 4.5 | 2.0 | | | 2.0 | | V | |
| | | 5.5 | 2.0 | | | 20 | | | |
| V_{IL} | LOW Level Input Voltage | 4.5 | | | 0.8 | | 0.8 | V | |
| | | 5.5 | | | 0.8 | | 0.8 | | |
| V_{OH} | HIGH Level Output Voltage | 4.5 | 4.40 | 4.50 | | 4.40 | | V | $V_{IN} = V_{IH}$ $I_{OH} = -50 \mu A$ |
| | | | 3.94 | | | 3.80 | | V | or V_{IL} $I_{OH} = -8 mA$ |
| V_{OL} | LOW Level Output Voltage | 4.5 | 0.0 | 0.1 | | 0.1 | | V | $V_{IN} = V_{IH}$ $I_{OL} = 50 \mu A$ |
| | | | | 0.36 | | 0.44 | | V | or V_{IL} $I_{OL} = 8 mA$ |
| I_{OZ} | 3-STATE Output Off-State Current | 5.5 | | ± 0.25 | | ± 2.5 | | μA | $V_{IN} = V_{IH}$ or V_{IL} $V_{OUT} = V_{CC}$ or GND |
| I_{IN} | Input Leakage Current | 0-5.5 | | ± 0.1 | | ± 1.0 | | μA | $V_{IN} = 5.5V$ or GND |
| I_{CC} | Quiescent Supply Current | 5.5 | | 4.0 | | 40.0 | | μA | $V_{IN} = V_{CC}$ or GND |
| I_{CCT} | Maximum $I_{CC}/Input$ | 5.5 | | 1.35 | | 1.50 | | mA | $V_{IN} = 3.4V$ Other Input = V_{CC} or GND |
| I_{OFF} | Output Leakage Current (Power Down State) | 0.0 | | 0.5 | | 5.0 | | μA | $V_{OUT} = 5.5V$ |

Noise Characteristics

| Symbol | Parameter | V _{CC} (V) | T _A = 25°C | | Units | Conditions |
|------------------------------|--|------------------------|-----------------------|--------|-------|------------------------|
| | | | Typ | Limits | | |
| V _{OLP} (Note 7) | Quiet Output Maximum Dynamic V _{OL} | 5.0 | 1.2 | 1.6 | V | C _L = 50 pF |
| V _{OLV} (Note 7) | Quiet Output Minimum Dynamic V _{OL} | 5.0 | -1.2 | -1.6 | V | C _L = 50 pF |
| V _{IHD} (Note 7) | Minimum HIGH Level Dynamic Input Voltage | 5.0 | | 2.0 | V | C _L = 50 pF |
| V _{ILD} (Note 7) | Maximum LOW Level Dynamic Input Voltage | 5.0 | | 0.8 | V | C _L = 50 pF |

Note 7: Parameter guaranteed by design.

AC Electrical Characteristics

| Symbol | Parameter | V _{CC} (V) | T _A = 25°C | | | T _A = -40°C to +85°C | | Units | Conditions |
|-------------------|-------------------------------|------------------------|-----------------------|------|-----|---------------------------------|-----|------------------------|------------|
| | | | Min | Typ | Max | Min | Max | | |
| t _{PLH} | Propagation Delay Time | 5.0 ± 0.5 | 4.1 | 9.4 | 1.0 | 10.5 | ns | C _L = 15 pF | |
| t _{PHL} | | | 5.6 | 10.4 | 1.0 | 11.5 | | C _L = 50 pF | |
| t _{PZL} | 3-STATE Output Enable Time | 5.0 ± 0.5 | 6.5 | 10.2 | 1.0 | 11.5 | ns | R _L = 1 kΩ | |
| t _{PZH} | | | 7.3 | 11.2 | 1.0 | 12.5 | | C _L = 50 pF | |
| t _{PLZ} | 3-STATE Output Disable Time | 5.0 ± 0.5 | 7.0 | 11.2 | 1.0 | 12.0 | ns | R _L = 1 kΩ | |
| t _{PHZ} | | | | | | | | C _L = 50 pF | |
| t _{OSLH} | Output to Output Skew | 5.0 ± 0.5 | | 1.0 | | 1.0 | ns | (Note 8) | |
| t _{OSHL} | | | | | | | | | |
| f _{MAX} | Maximum Clock Frequency | 5.0 ± 0.5 | 90 | 140 | 80 | | MHz | C _L = 15 pF | |
| | | | 85 | 130 | 75 | | | C _L = 50 pF | |
| C _{IN} | Input Capacitance | | 4 | 10 | | 10 | pF | V _{CC} = Open | |
| C _{OUT} | Output Capacitance | | 9 | | | | pF | V _{CC} = 5.0V | |
| C _{PD} | Power Dissipation Capacitance | | 25 | | | | pF | (Note 9) | |

Note 8: Parameter guaranteed by design. t_{OSLH} = |t_{PLH max} - t_{PLH min}|; t_{OSHL} = |t_{PHL max} - t_{PHL min}|

Note 9: C_{PD} is defined as the value of the internal equivalent capacitance which is calculated from the operating current consumption without load. Average operating current can be obtained by the equation: I_{CC (opr.)} = C_{PD} * V_{CC} * f_{IN} + I_{CC}/8 (per F/F). The total C_{PD} when n pcs. of the Octal D Flip-Flop operates can be calculated by the equation: C_{PD (total)} = 20 + 12n.

AC Operating Requirements

| Symbol | Parameter | V _{CC} (V) | T _A = 25°C | | | T _A = -40°C to +85°C | | Units |
|-------------------|--------------------------|------------------------|-----------------------|-----|-----|---------------------------------|-----|-------|
| | | | Min | Typ | Max | Min | Max | |
| t _{W(H)} | Minimum Pulse Width (CP) | 5.0 ± 0.5 | 6.5 | | | 8.5 | ns | |
| t _{W(L)} | | | | | | | | |
| t _S | Minimum Set-Up Time | 5.0 ± 0.5 | 2.5 | | | 2.5 | ns | |
| t _H | Minimum Hold Time | 5.0 ± 0.5 | 2.5 | | | 2.5 | | |

Physical Dimensions inches (millimeters) unless otherwise noted

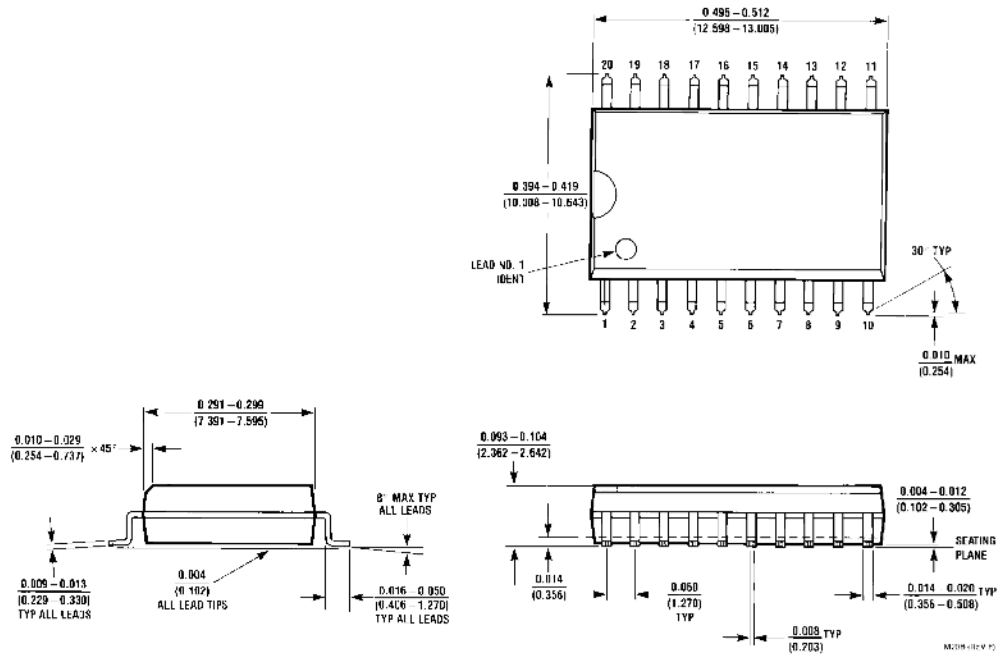

20-Lead Small Outline Integrated Circuit (SOIC), JEDEC MS-013, 0.300" Wide
Package Number M20B

Physical Dimensions inches (millimeters) unless otherwise noted (Continued)

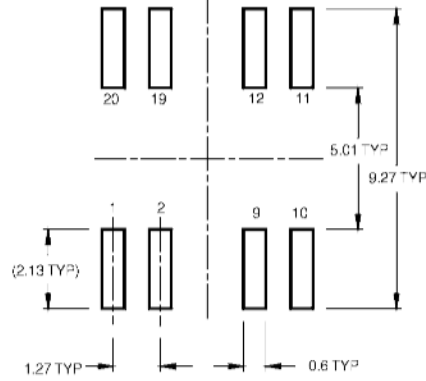
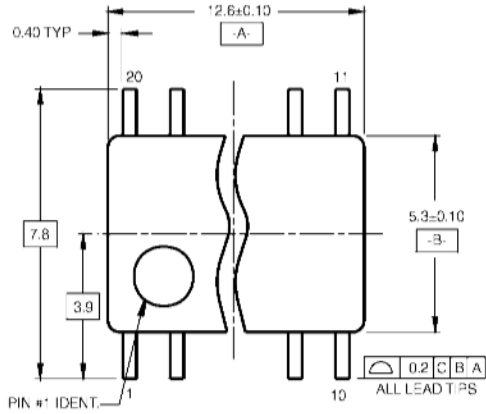

LAND PATTERN RECOMMENDATION

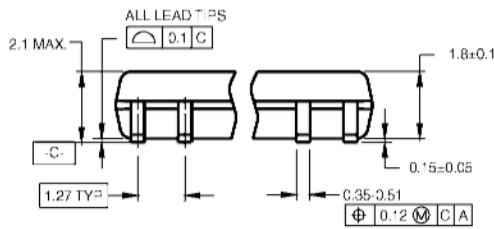

DIMENSIONS ARE IN MILLIMETERS

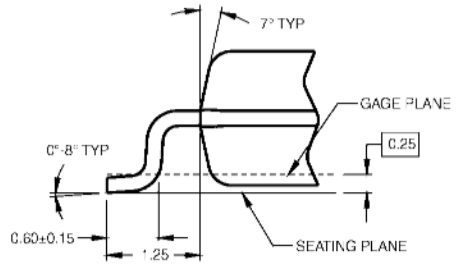
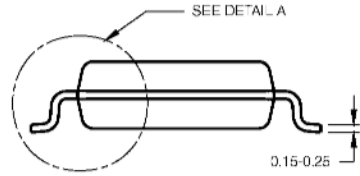

DETAIL A

NOTES:

- A. CONFORMS TO EIAJ EDP-7320 REGISTRATION, ESTABLISHED IN DECEMBER, 1998.
- B. DIMENSIONS ARE IN MILLIMETERS.
- C. DIMENSIONS ARE EXCLUSIVE OF BURRS, VOLD FLASH, AND TIE BAR EXTRUSIONS.

M20DRevB1

Pb-Free 20-Lead Small Outline Package (SOP), EIAJ TYPE II, 5.3mm Wide Package Number M20D

Physical Dimensions inches (millimeters) unless otherwise noted (Continued)

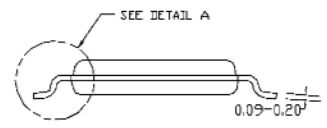
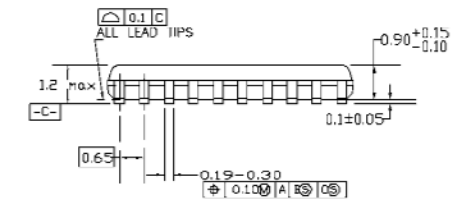
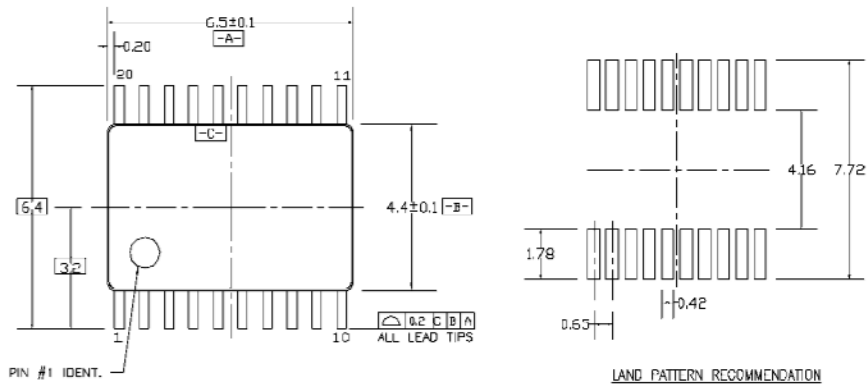

DIMENSIONS ARE IN MILLIMETERS

- NOTES:
- A. CONFORMS TO JEDEC REGISTRATION MU-153, VARIATION AC, REF NOTE 6, DATE 7/93.
 - B. DIMENSIONS ARE IN MILLIMETERS.
 - C. DIMENSIONS ARE EXCLUSIVE OF BURRS, MOLDS FLASH, AND TIE BAR EXTRUSIONS.
 - D. DIMENSIONS AND TOLERANCES PER ANSI Y14.5M, 1982.

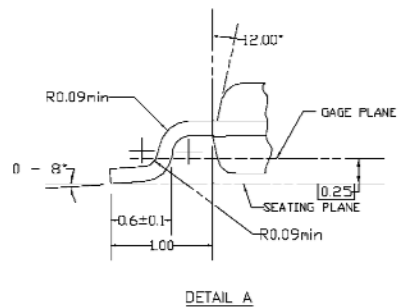

MTC20REVD1

20-Lead Thin Shrink Small Outline Package (TSSOP), JEDEC MO-153, 4.4mm Wide Package Number MTC20

ON Semiconductor and  are trademarks of Semiconductor Components Industries, LLC dba ON Semiconductor or its subsidiaries in the United States and/or other countries. ON Semiconductor owns the rights to a number of patents, trademarks, copyrights, trade secrets, and other intellectual property. A listing of ON Semiconductor's product/patent coverage may be accessed at www.onsemi.com/site/pdf/Patent-Marking.pdf. ON Semiconductor reserves the right to make changes without further notice to any products herein. ON Semiconductor makes no warranty, representation or guarantee regarding the suitability of its products for any particular purpose, nor does ON Semiconductor assume any liability arising out of the application or use of any product or circuit, and specifically disclaims any and all liability, including without limitation special, consequential or incidental damages. Buyer is responsible for its products and applications using ON Semiconductor products, including compliance with all laws, regulations and safety requirements or standards, regardless of any support or applications information provided by ON Semiconductor. "Typical" parameters which may be provided in ON Semiconductor data sheets and/or specifications can and do vary in different applications and actual performance may vary over time. All operating parameters, including "Typicals" must be validated for each customer application by customer's technical experts. ON Semiconductor does not convey any license under its patent rights nor the rights of others. ON Semiconductor products are not designed, intended, or authorized for use as a critical component in life support systems or any FDA Class 3 medical devices or medical devices with a same or similar classification in a foreign jurisdiction or any devices intended for implantation in the human body. Should Buyer purchase or use ON Semiconductor products for any such unintended or unauthorized application, Buyer shall indemnify and hold ON Semiconductor and its officers, employees, subsidiaries, affiliates, and distributors harmless against all claims, costs, damages, and expenses, and reasonable attorney fees arising out of, directly or indirectly, any claim of personal injury or death associated with such unintended or unauthorized use, even if such claim alleges that ON Semiconductor was negligent regarding the design or manufacture of the part. ON Semiconductor is an Equal Opportunity/Affirmative Action Employer. This literature is subject to all applicable copyright laws and is not for resale in any manner.

PUBLICATION ORDERING INFORMATION

LITERATURE FULFILLMENT

Literature Distribution Center for ON Semiconductor
19521 E. 32nd Pkwy, Aurora, Colorado 80011 USA
Phone: 303-675-2175 or 800-344-3860 Toll Free USA/Canada
Fax: 303-675-2176 or 800-344-3867 Toll Free USA/Canada
Email: orderlit@onsemi.com

N. American Technical Support: 800-282-9855 Toll Free
USA/Canada
Europe, Middle East and Africa Technical Support:
Phone: 421 33 790 2910
Japan Customer Focus Center
Phone: 81-3-5817-1050

ON Semiconductor Website: www.onsemi.com
Order Literature: <http://www.onsemi.com/orderlit>

For additional information, please contact your local Sales Representative