

1N5913B Series

3 W DO-41 Surmetic 30 Zener Voltage Regulators

This is a complete series of 3 W Zener diodes with limits and excellent operating characteristics that reflect the superior capabilities of silicon-oxide passivated junctions. All this in an axial-lead, transfer-molded plastic package that offers protection in all common environmental conditions.

Features

- Zener Voltage Range - 3.3 V to 200 V
- ESD Rating of Class 3 (>16 KV) per Human Body Model
- Surge Rating of 98 W @ 1 ms
- Maximum Limits Guaranteed on up to Six Electrical Parameters
- Package No Larger than the Conventional 1 W Package
- Pb-Free Packages are Available

Mechanical Characteristics

CASE: Void free, transfer-molded, thermosetting plastic

FINISH: All external surfaces are corrosion resistant and leads are readily solderable

MAXIMUM LEAD TEMPERATURE FOR SOLDERING PURPOSES: 260°C, 1/16" from the case for 10 seconds

POLARITY: Cathode indicated by polarity band

MOUNTING POSITION: Any

MAXIMUM RATINGS

Rating	Symbol	Value	Unit
Max. Steady State Power Dissipation @ $T_L = 75^\circ\text{C}$, Lead Length = 3/8" Derate above 75°C	P_D	3	W
		24	mW/°C
Steady State Power Dissipation @ $T_A = 50^\circ\text{C}$ Derate above 50°C	P_D	1	W
		6.67	mW/°C
Operating and Storage Temperature Range	T_J, T_{stg}	-65 to +200	°C

Stresses exceeding those listed in the Maximum Ratings table may damage the device. If any of these limits are exceeded, device functionality should not be assumed, damage may occur and reliability may be affected.

*For additional information on our Pb-Free strategy and soldering details, please download the ON Semiconductor Soldering and Mounting Techniques Reference Manual, SOLDERRM/D.



ON Semiconductor®

www.onsemi.com

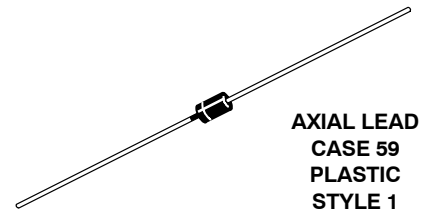
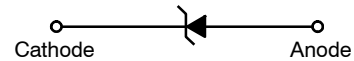

MARKING DIAGRAM

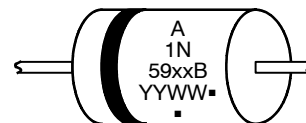

A = Assembly Location
 1N59xxB = Device Number
 YY = Year
 WW = Work Week
 ■ = Pb-Free Package
 (Note: Microdot may be in either location)

ORDERING INFORMATION

Device	Package	Shipping†
1N59xxB, G	Axial Lead (Pb-Free)	2000 Units/Box
1N59xxBRL, G	Axial Lead (Pb-Free)	6000/Tape & Reel

†For information on tape and reel specifications, including part orientation and tape sizes, please refer to our Tape and Reel Packaging Specification Brochure, BRD8011/D.

1N5913B Series

ELECTRICAL CHARACTERISTICS

($T_L = 30^\circ\text{C}$ unless otherwise noted,

$V_F = 1.5\text{ V Max @ } I_F = 200\text{ mAdc}$ for all types)

Symbol	Parameter
V_Z	Reverse Zener Voltage @ I_{ZT}
I_{ZT}	Reverse Current
Z_{ZT}	Maximum Zener Impedance @ I_{ZT}
I_{ZK}	Reverse Current
Z_{ZK}	Maximum Zener Impedance @ I_{ZK}
I_R	Reverse Leakage Current @ V_R
V_R	Breakdown Voltage
I_F	Forward Current
V_F	Forward Voltage @ I_F
I_{ZM}	Maximum DC Zener Current

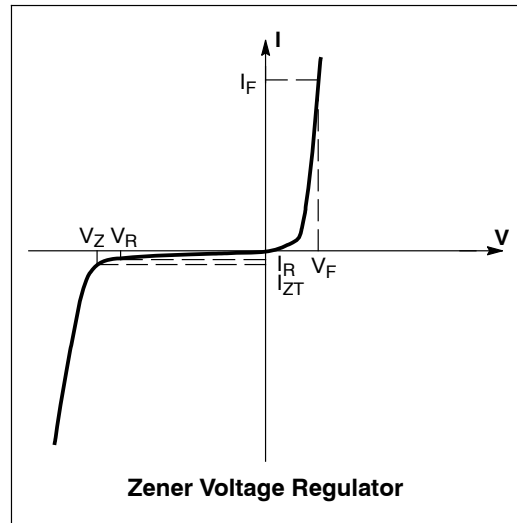

1N5913B Series

ELECTRICAL CHARACTERISTICS ($T_L = 30^\circ\text{C}$ unless otherwise noted, $V_F = 1.5\text{ V Max}$ @ $I_F = 200\text{ mAdc}$ for all types)

Device [†] (Note 1)	Device Marking	Zener Voltage (Note 2)				Zener Impedance (Note 3)			Leakage Current		I _{ZM} mA
		V _Z (Volts)			@ I _{ZT}	Z _{ZT} @ I _{ZT}	Z _{ZK} @ I _{ZK}		I _R @ V _R		
		Min	Nom	Max	mA	Ω	Ω	mA	μA Max	Volts	
1N5913B, G	1N5913B	3.14	3.3	3.47	113.6	10	500	1	100	1	454
1N5917B, G	1N5917B	4.47	4.7	4.94	79.8	5	500	1	5	1.5	319
1N5919B, G	1N5919B	5.32	5.6	5.88	66.9	2	250	1	5	3	267
1N5920B, G	1N5920B	5.89	6.2	6.51	60.5	2	200	1	5	4	241
1N5921B, G	1N5921B	6.46	6.8	7.14	55.1	2.5	200	1	5	5.2	220
1N5923B, G	1N5923B	7.79	8.2	8.61	45.7	3.5	400	0.5	5	6.5	182
1N5924B, G	1N5924B	8.65	9.1	9.56	41.2	4	500	0.5	5	7	164
1N5925B, G	1N5925B	9.50	10	10.50	37.5	4.5	500	0.25	5	8	150
1N5926B, G	1N5926B	10.45	11	11.55	34.1	5.5	550	0.25	1	8.4	136
1N5927B, G	1N5927B	11.40	12	12.60	31.2	6.5	550	0.25	1	9.1	125
1N5929B, G	1N5929B	14.25	15	15.75	25.0	9	600	0.25	1	11.4	100
1N5930B, G	1N5930B	15.20	16	16.80	23.4	10	600	0.25	1	12.2	93
1N5931B, G	1N5931B	17.10	18	18.90	20.8	12	650	0.25	1	13.7	83
1N5932B, G	1N5932B	19.00	20	21.00	18.7	14	650	0.25	1	15.2	75
1N5933B, G	1N5933B	20.90	22	23.10	17.0	17.5	650	0.25	1	16.7	68
1N5934B, G	1N5934B	22.80	24	25.20	15.6	19	700	0.25	1	18.2	62
1N5935B, G	1N5935B	25.65	27	28.35	13.9	23	700	0.25	1	20.6	55
1N5936B, G	1N5936B	28.50	30	31.50	12.5	28	750	0.25	1	22.8	50
1N5937B, G	1N5937B	31.35	33	34.65	11.4	33	800	0.25	1	25.1	45
1N5938B, G	1N5938B	34.20	36	37.80	10.4	38	850	0.25	1	27.4	41
1N5940B, G	1N5940B	40.85	43	45.15	8.7	53	950	0.25	1	32.7	34
1N5941B, G	1N5941B	44.65	47	49.35	8.0	67	1000	0.25	1	35.8	31
1N5942B, G	1N5942B	48.45	51	53.55	7.3	70	1100	0.25	1	38.8	29
1N5943B, G	1N5943B	53.20	56	58.80	6.7	86	1300	0.25	1	42.6	26
1N5944B, G	1N5944B	58.90	62	65.10	6.0	100	1500	0.25	1	47.1	24
1N5946B, G	1N5946B	71.25	75	78.75	5.0	140	2000	0.25	1	56	20
1N5947B, G	1N5947B	77.90	82	86.10	4.6	160	2500	0.25	1	62.2	18
1N5948B, G	1N5948B	86.45	91	95.55	4.1	200	3000	0.25	1	69.2	16
1N5950B, G	1N5950B	104.5	110	115.5	3.4	300	4000	0.25	1	83.6	13
1N5951B, G	1N5951B	114	120	126	3.1	380	4500	0.25	1	91.2	12
1N5952B, G	1N5952B	123.5	130	136.5	2.9	450	5000	0.25	1	98.8	11
1N5953B, G	1N5953B	142.5	150	157.5	2.5	600	6000	0.25	1	114	10
1N5954B, G	1N5954B	152	160	168	2.3	700	6500	0.25	1	121.6	9
1N5955B, G	1N5955B	171	180	189	2.1	900	7000	0.25	1	136.8	8
1N5956B, G	1N5956B	190	200	210	1.9	1200	8000	0.25	1	152	7

Devices listed in **bold, italic** are ON Semiconductor **Preferred** devices. **Preferred** devices are recommended choices for future use and best overall value.

†The "G" suffix indicates Pb- Free package available.

1. TOLERANCE AND TYPE NUMBER DESIGNATION

Tolerance designation - device tolerance of ±5% are indicated by a "B" suffix.

2. ZENER VOLTAGE (V_Z) MEASUREMENT

ON Semiconductor guarantees the zener voltage when measured at 90 seconds while maintaining the lead temperature (T_L) at 30°C ±1°C, 3/8" from the diode body.

3. ZENER IMPEDANCE (Z_Z) DERIVATION

The zener impedance is derived from 60 seconds AC voltage, which results when an AC current having an rms value equal to 10% of the DC zener current (I_{ZT} or I_{ZK}) is superimposed on I_{ZT} or I_{ZK}.

1N5913B Series

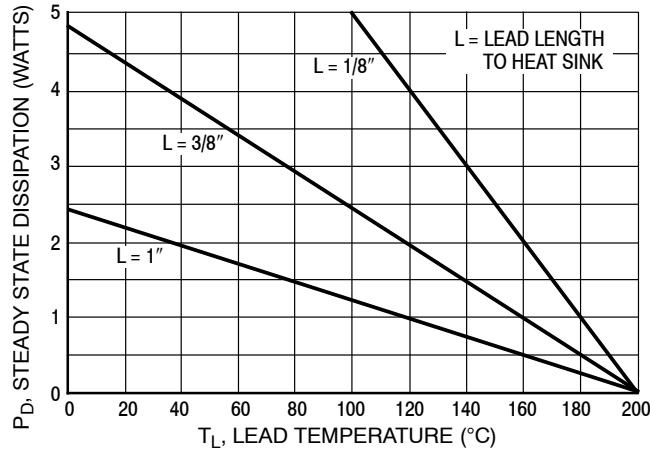

Figure 1. Power Temperature Derating Curve

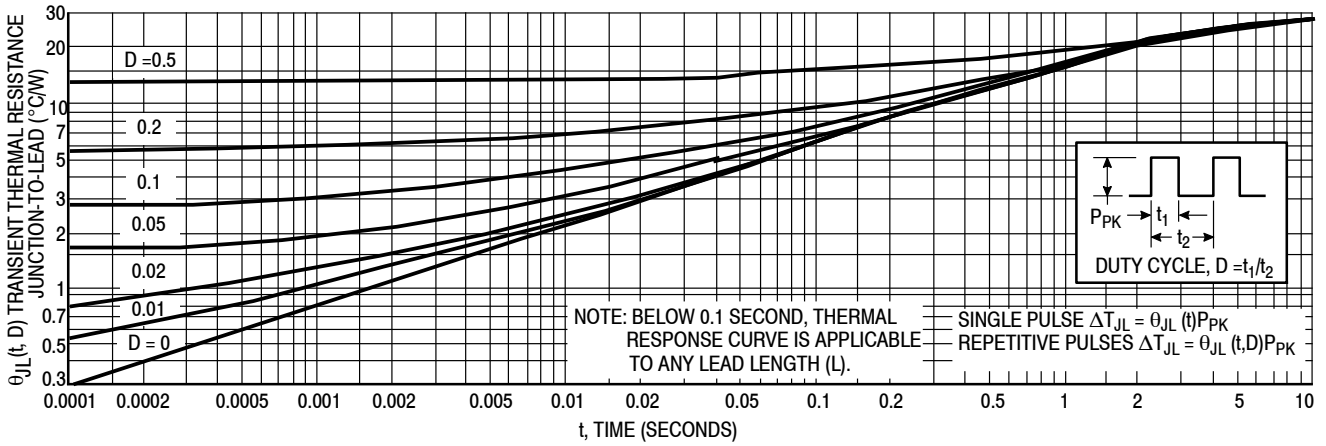

Figure 2. Typical Thermal Response L, Lead Length = 3/8 Inch

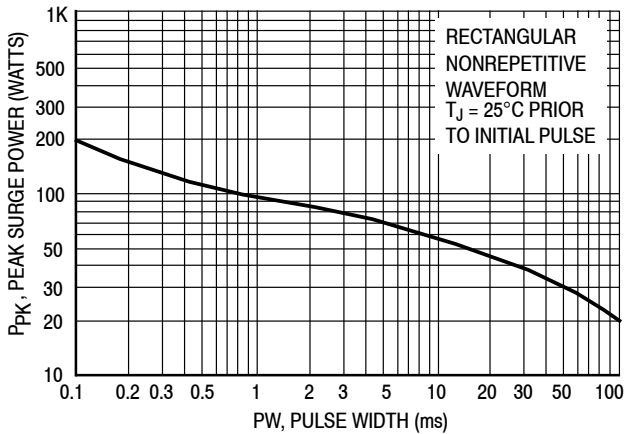

Figure 3. Maximum Surge Power

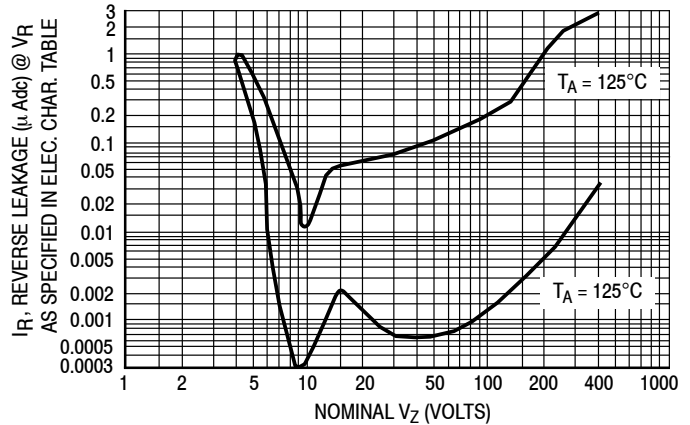

Figure 4. Typical Reverse Leakage

APPLICATION NOTE

Since the actual voltage available from a given zener diode is temperature dependent, it is necessary to determine junction temperature under any set of operating conditions in order to calculate its value. The following procedure is recommended:

Lead Temperature, T_L , should be determined from:

$$T_L = \theta_{LA} P_D + T_A$$

θ_{LA} is the lead-to-ambient thermal resistance ($^{\circ}\text{C}/\text{W}$) and P_D is the power dissipation. The value for θ_{LA} will vary and depends on the device mounting method. θ_{LA} is generally 30-40 $^{\circ}\text{C}/\text{W}$ for the various clips and tie points in common use and for printed circuit board wiring.

The temperature of the lead can also be measured using a thermocouple placed on the lead as close as possible to the tie point. The thermal mass connected to the tie point is normally large enough so that it will not significantly respond to heat surges generated in the diode as a result of pulsed operation once steady-state conditions are achieved. Using the measured value of T_L , the junction temperature may be determined by:

$$T_J = T_L + \Delta T_{JL}$$

ΔT_{JL} is the increase in junction temperature above the lead temperature and may be found from Figure 2 for a train of power pulses ($L = 3/8$ inch) or from Figure 10 for dc power.

$$\Delta T_{JL} = \theta_{JL} P_D$$

For worst-case design, using expected limits of I_Z , limits of P_D and the extremes of T_J (ΔT_J) may be estimated. Changes in voltage, V_Z , can then be found from:

$$\Delta V = \theta_{VZ} \Delta T_J$$

θ_{VZ} , the zener voltage temperature coefficient, is found from Figures 5 and 6.

Under high power-pulse operation, the zener voltage will vary with time and may also be affected significantly by the zener resistance. For best regulation, keep current excursions as low as possible.

Data of Figure 2 should not be used to compute surge capability. Surge limitations are given in Figure 3. They are lower than would be expected by considering only junction temperature, as current crowding effects cause temperatures to be extremely high in small spots resulting in device degradation should the limits of Figure 3 be exceeded.

1N5913B Series

TEMPERATURE COEFFICIENT RANGES

(90% of the Units are in the Ranges Indicated)

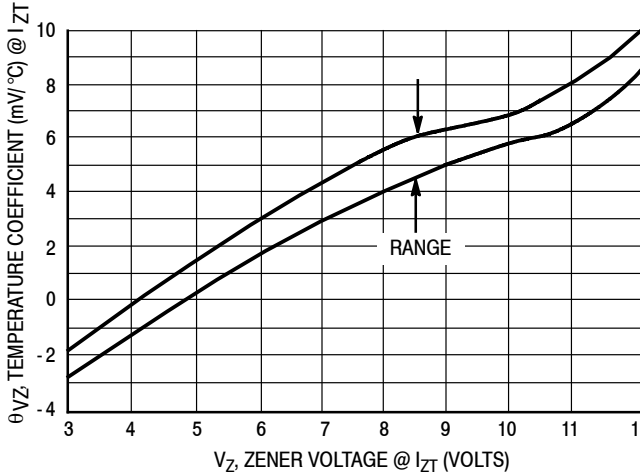

Figure 5. Units To 12 Volts

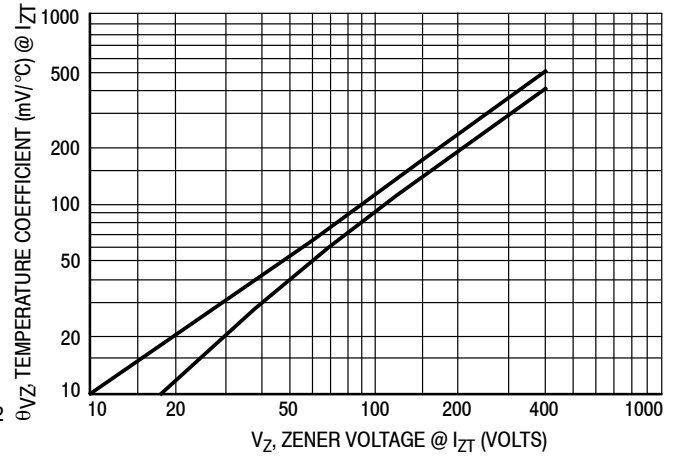

Figure 6. Units 10 To 400 Volts

ZENER VOLTAGE versus ZENER CURRENT

(Figures 7, 8 and 9)

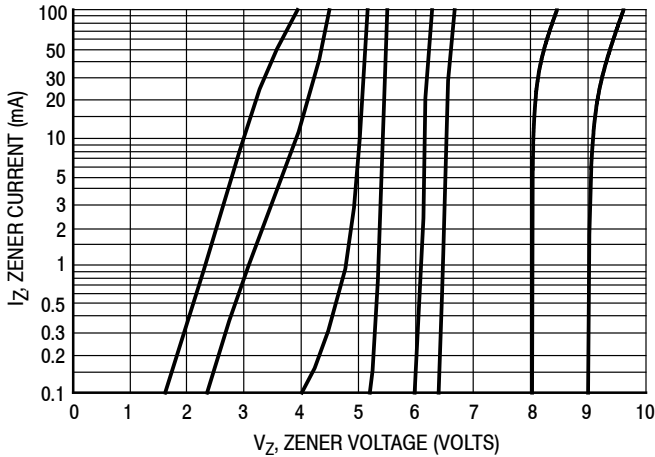

Figure 7. $V_Z = 3.3$ thru 10 Volts

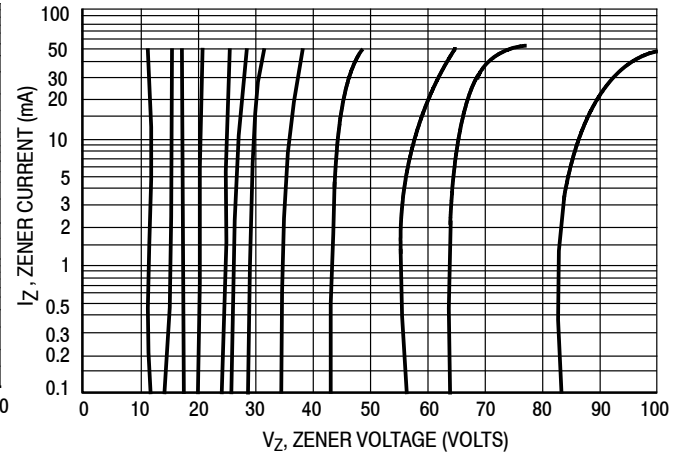

Figure 8. $V_Z = 12$ thru 82 Volts

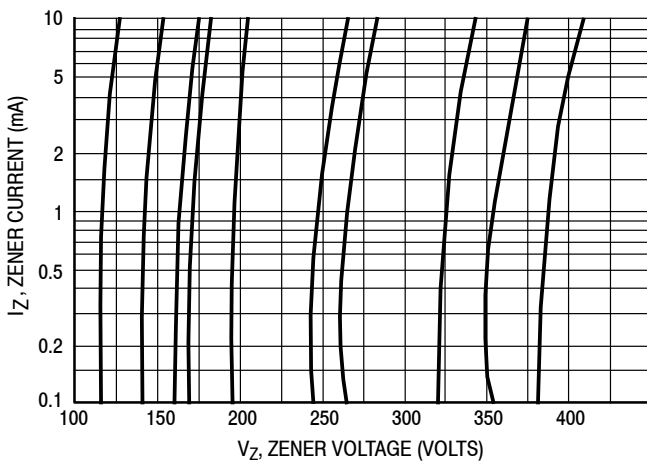

Figure 9. $V_Z = 100$ thru 400 Volts

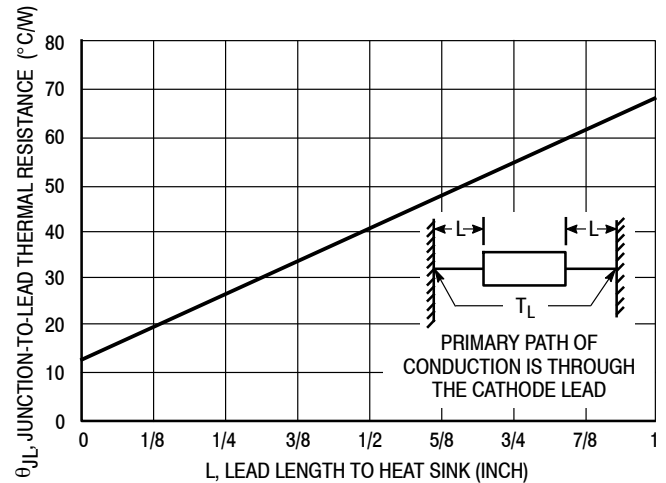

Figure 10. Typical Thermal Resistance

MECHANICAL CASE OUTLINE

PACKAGE DIMENSIONS

ON Semiconductor®



AXIAL LEAD CASE 59-10 ISSUE U

DATE 15 FEB 2005

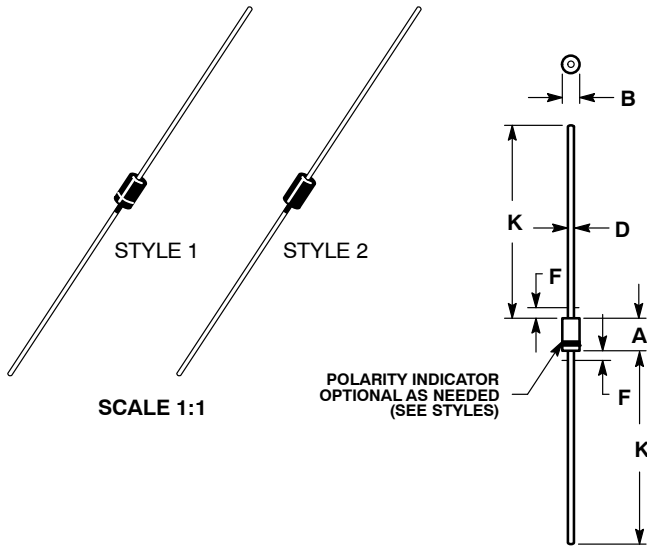

SCALE 1:1

POLARITY INDICATOR
OPTIONAL AS NEEDED
(SEE STYLES)

STYLE 1:
PIN 1. CATHODE (POLARITY BAND)
2. ANODE

STYLE 2:
NO POLARITY

NOTES:

1. DIMENSIONING AND TOLERANCING PER ANSI Y14.5M, 1982.
2. CONTROLLING DIMENSION: INCH.
3. ALL RULES AND NOTES ASSOCIATED WITH JEDEC DO-41 OUTLINE SHALL APPLY
4. POLARITY DENOTED BY CATHODE BAND.
5. LEAD DIAMETER NOT CONTROLLED WITHIN F DIMENSION.

DIM	INCHES		MILLIMETERS	
	MIN	MAX	MIN	MAX
A	0.161	0.205	4.10	5.20
B	0.079	0.106	2.00	2.70
D	0.028	0.034	0.71	0.86
F	---	0.050	---	1.27
K	1.000	---	25.40	---

GENERIC MARKING DIAGRAM*

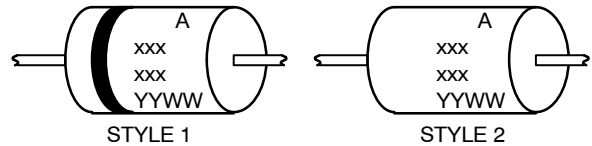

- xxx = Specific Device Code
- A = Assembly Location
- YY = Year
- WW = Work Week

*This information is generic. Please refer to device data sheet for actual part marking. Pb-Free indicator, "G" or microdot "▪", may or may not be present.

DOCUMENT NUMBER:	98ASB42045B	Electronic versions are uncontrolled except when accessed directly from the Document Repository. Printed versions are uncontrolled except when stamped "CONTROLLED COPY" in red.
DESCRIPTION:	AXIAL LEAD	PAGE 1 OF 1

ON Semiconductor and are trademarks of Semiconductor Components Industries, LLC dba ON Semiconductor or its subsidiaries in the United States and/or other countries. ON Semiconductor reserves the right to make changes without further notice to any products herein. ON Semiconductor makes no warranty, representation or guarantee regarding the suitability of its products for any particular purpose, nor does ON Semiconductor assume any liability arising out of the application or use of any product or circuit, and specifically disclaims any and all liability, including without limitation special, consequential or incidental damages. ON Semiconductor does not convey any license under its patent rights nor the rights of others.

ON Semiconductor and  are trademarks of Semiconductor Components Industries, LLC dba ON Semiconductor or its subsidiaries in the United States and/or other countries. ON Semiconductor owns the rights to a number of patents, trademarks, copyrights, trade secrets, and other intellectual property. A listing of ON Semiconductor's product/patent coverage may be accessed at www.onsemi.com/site/pdf/Patent-Marking.pdf. ON Semiconductor reserves the right to make changes without further notice to any products herein. ON Semiconductor makes no warranty, representation or guarantee regarding the suitability of its products for any particular purpose, nor does ON Semiconductor assume any liability arising out of the application or use of any product or circuit, and specifically disclaims any and all liability, including without limitation special, consequential or incidental damages. Buyer is responsible for its products and applications using ON Semiconductor products, including compliance with all laws, regulations and safety requirements or standards, regardless of any support or applications information provided by ON Semiconductor. "Typical" parameters which may be provided in ON Semiconductor data sheets and/or specifications can and do vary in different applications and actual performance may vary over time. All operating parameters, including "Typicals" must be validated for each customer application by customer's technical experts. ON Semiconductor does not convey any license under its patent rights nor the rights of others. ON Semiconductor products are not designed, intended, or authorized for use as a critical component in life support systems or any FDA Class 3 medical devices or medical devices with a same or similar classification in a foreign jurisdiction or any devices intended for implantation in the human body. Should Buyer purchase or use ON Semiconductor products for any such unintended or unauthorized application, Buyer shall indemnify and hold ON Semiconductor and its officers, employees, subsidiaries, affiliates, and distributors harmless against all claims, costs, damages, and expenses, and reasonable attorney fees arising out of, directly or indirectly, any claim of personal injury or death associated with such unintended or unauthorized use, even if such claim alleges that ON Semiconductor was negligent regarding the design or manufacture of the part. ON Semiconductor is an Equal Opportunity/Affirmative Action Employer. This literature is subject to all applicable copyright laws and is not for resale in any manner.

PUBLICATION ORDERING INFORMATION

LITERATURE FULFILLMENT:

Email Requests to: orderlit@onsemi.com

ON Semiconductor Website: www.onsemi.com

TECHNICAL SUPPORT

North American Technical Support:
Voice Mail: 1 800-282-9855 Toll Free USA/Canada
Phone: 011 421 33 790 2910

Europe, Middle East and Africa Technical Support:

Phone: 00421 33 790 2910

For additional information, please contact your local Sales Representative