

# NTMFS4946N

## MOSFET – Power, Single, N-Channel, SO-8 FL 30 V, 100 A

- Low  $R_{DS(on)}$  to Minimize Conduction Losses
- Low Capacitance to Minimize Driver Losses
- Optimized Gate Charge to Minimize Switching Losses
- Thermally Enhanced SO8 Package
- These are Pb-Free Device

### Applications

- CPU Power Delivery
- DC-DC Converters
- Low Side Switching

### MAXIMUM RATINGS ( $T_J = 25^\circ\text{C}$ unless otherwise stated)

| Parameter  | Symbol                   | Value                    | Unit     |                  |   |
|--|--------------------------|--------------------------|----------|------------------|---|
| Drain-to-Source Voltage                              | $V_{DSS}$                | 30                       | V        |                  |   |
| Gate-to-Source Voltage                               | $V_{GS}$                 | $\pm 20$                 | V        |                  |   |
| Continuous Drain Current $R_{\theta JA}$ (Note 1)    | $I_D$                    | $T_A = 25^\circ\text{C}$ | 20.3     | A                |   |
|  |                          | $T_A = 85^\circ\text{C}$ | 14.6     |                  |   |
| Power Dissipation $R_{\theta JA}$ (Note 1)           | $P_D$                    | 2.25                     | W        |                  |   |
| Continuous Drain Current $R_{\theta JA} \leq 10$ sec | $I_D$                    | $T_A = 25^\circ\text{C}$ | 32.8     | A                |   |
|  |                          | $T_A = 85^\circ\text{C}$ | 23.7     |                  |   |
| Power Dissipation $R_{\theta JA}, t \leq 10$ sec     | $P_D$                    | 5.90                     | W        |                  |   |
| Continuous Drain Current $R_{\theta JA}$ (Note 2)    | $I_D$                    | $T_A = 25^\circ\text{C}$ | 12.7     | A                |   |
|  |                          | $T_A = 85^\circ\text{C}$ | 9.2      |                  |   |
| Power Dissipation $R_{\theta JA}$ (Note 2)           | $P_D$                    | 0.89                     | W        |                  |   |
| Continuous Drain Current $R_{\theta JC}$ (Note 1)    | $I_D$                    | $T_C = 25^\circ\text{C}$ | 100      | A                |   |
|  |                          | $T_C = 85^\circ\text{C}$ | 72       |                  |   |
| Power Dissipation $R_{\theta JC}$ (Note 1)           | $P_D$                    | 55.5                     | W        |                  |   |
| Pulsed Drain Current                                 | $t_p = 10\mu\text{s}$    | $T_A = 25^\circ\text{C}$ | $I_{DM}$ | 200              | A |
| Current limited by package                           | $T_A = 25^\circ\text{C}$ | $I_{Dmaxpkg}$            | 100      | A                |   |
| Operating Junction and Storage Temperature           | $T_J, T_{STG}$           | -55 to +150              |          | $^\circ\text{C}$ |   |
| Source Current (Body Diode)                          | $I_S$                    | 55                       |          | A                |   |
| Drain to Source dV/dt                                | dV/dt                    | 6                        |          | V/ns             |   |



ON Semiconductor®

<http://onsemi.com>

| $V_{(BR)DSS}$ | $R_{DS(ON)}$ MAX       | $I_D$ MAX |
|---------------|------------------------|-----------|
| 30 V          | 3.4 m $\Omega$ @ 10 V  | 100 A     |
|               | 5.1 m $\Omega$ @ 4.5 V |           |

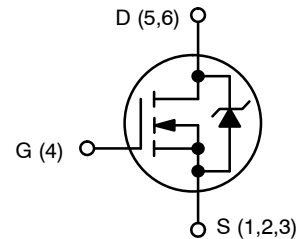

N-CHANNEL MOSFET

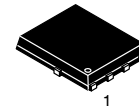

SO-8 FLAT LEAD  
CASE 488AA  
STYLE 1

### MARKING DIAGRAM

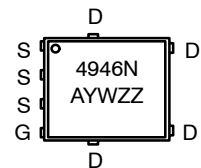

- A = Assembly Location
- Y = Year
- W = Work Week
- ZZ = Lot Traceability

### ORDERING INFORMATION

| Device        | Package          | Shipping†          |
|---------------|------------------|--------------------|
| NTMFS4946NT1G | SO-8FL (Pb-Free) | 1500 / Tape & Reel |
| NTMFS4946NT3G | SO-8FL (Pb-Free) | 5000 / Tape & Reel |

†For information on tape and reel specifications, including part orientation and tape sizes, please refer to our Tape and Reel Packaging Specifications Brochure, BRD8011/D.

# NTMFS4946N

## MAXIMUM RATINGS ( $T_J = 25^\circ\text{C}$ unless otherwise stated)

| Parameter   | Symbol | Value | Unit             |
|---|--------|-------|------------------|
| Single Pulse Drain-to-Source Avalanche Energy ( $V_{DD} = 50\text{ V}$ , $V_{GS} = 10\text{ V}$ , $I_L = 37\text{ A}_{pk}$ , $L = 0.3\text{ mH}$ , $R_G = 25\ \Omega$ ) | EAS    | 205   | mJ               |
| Lead Temperature for Soldering Purposes (1/8" from case for 10 s)   | $T_L$  | 260   | $^\circ\text{C}$ |

Stresses exceeding Maximum Ratings may damage the device. Maximum Ratings are stress ratings only. Functional operation above the Recommended Operating Conditions is not implied. Extended exposure to stresses above the Recommended Operating Conditions may affect device reliability.

# NTMFS4946N

## THERMAL RESISTANCE MAXIMUM RATINGS

| Parameter                                   | Symbol          | Value | Unit |
|---|-----------------|-------|------|
| Junction-to-Case (Drain)                    | $R_{\theta JC}$ | 2.25  | °C/W |
| Junction-to-Ambient – Steady State (Note 1) | $R_{\theta JA}$ | 55.6  |      |
| Junction-to-Ambient – Steady State (Note 2) | $R_{\theta JA}$ | 140.8 |      |
| Junction-to-Ambient – $t \leq 10$ sec       | $R_{\theta JA}$ | 21.2  |      |

- Surface-mounted on FR4 board using 1 sq-in pad, 1 oz Cu.
- Surface-mounted on FR4 board using the minimum recommended pad size.

## ELECTRICAL CHARACTERISTICS ( $T_J = 25^\circ\text{C}$ unless otherwise specified)

| Parameter | Symbol | Test Condition | Min | Typ | Max | Unit |
|-----------|--------|----------------|-----|-----|-----|------|
|-----------|--------|----------------|-----|-----|-----|------|

### OFF CHARACTERISTICS

|   |                   |   |                           |    |           |               |
|---|-------------------|---|---------------------------|----|-----------|---------------|
| Drain-to-Source Breakdown Voltage                         | $V_{(BR)DSS}$     | $V_{GS} = 0\text{ V}, I_D = 250\ \mu\text{A}$   | 30                        |    |           | V             |
| Drain-to-Source Breakdown Voltage Temperature Coefficient | $V_{(BR)DSS}/T_J$ |   |                           | 25 |           | mV/°C         |
| Zero Gate Voltage Drain Current                           | $I_{DSS}$         | $V_{GS} = 0\text{ V}, V_{DS} = 24\text{ V}$     | $T_J = 25^\circ\text{C}$  |    | 1         | $\mu\text{A}$ |
|   |                   |   | $T_J = 125^\circ\text{C}$ |    | 10        |               |
| Gate-to-Source Leakage Current                            | $I_{GSS}$         | $V_{DS} = 0\text{ V}, V_{GS} = \pm 20\text{ V}$ |                           |    | $\pm 100$ | nA            |

### ON CHARACTERISTICS (Note 3)

|  |                  |  |                     |     |     |       |    |
|--|------------------|--|---------------------|-----|-----|-------|----|
| Gate Threshold Voltage                     | $V_{GS(TH)}$     | $V_{GS} = V_{DS}, I_D = 250\ \mu\text{A}$  | 1.45                | 1.8 | 2.5 | V     |    |
| Negative Threshold Temperature Coefficient | $V_{GS(TH)}/T_J$ |  |                     | 5.2 |     | mV/°C |    |
| Drain-to-Source On Resistance              | $R_{DS(on)}$     | $V_{GS} = 10\text{ V to } 11.5\text{ V}$   | $I_D = 30\text{ A}$ |     | 2.5 | 3.4   | mΩ |
|  |                  |  | $I_D = 15\text{ A}$ |     | 2.4 |       |    |
|  |                  | $V_{GS} = 4.5\text{ V}$                    | $I_D = 30\text{ A}$ |     | 3.8 | 5.1   |    |
|  |                  |  | $I_D = 15\text{ A}$ |     | 3.8 |       |    |
| Forward Transconductance                   | $g_{FS}$         | $V_{DS} = 1.5\text{ V}, I_D = 30\text{ A}$ |                     | 85  |     | S     |    |

### CHARGES AND CAPACITANCES

|                              |              |   |  |      |    |    |
|------------------------------|--------------|---|--|------|----|----|
| Input Capacitance            | $C_{ISS}$    | $V_{GS} = 0\text{ V}, f = 1\text{ MHz}, V_{DS} = 12\text{ V}$     |  | 3250 |    | pF |
| Output Capacitance           | $C_{OSS}$    |   |  | 562  |    |    |
| Reverse Transfer Capacitance | $C_{RSS}$    |   |  | 289  |    |    |
| Total Gate Charge            | $Q_{G(TOT)}$ | $V_{GS} = 4.5\text{ V}, V_{DS} = 15\text{ V}, I_D = 30\text{ A}$  |  | 21.8 | 32 | nC |
| Threshold Gate Charge        | $Q_{G(TH)}$  |   |  | 3.2  |    |    |
| Gate-to-Source Charge        | $Q_{GS}$     |   |  | 8.1  |    |    |
| Gate-to-Drain Charge         | $Q_{GD}$     |   |  | 7.4  |    |    |
| Total Gate Charge            | $Q_{G(TOT)}$ | $V_{GS} = 11.5\text{ V}, V_{DS} = 15\text{ V}, I_D = 30\text{ A}$ |  | 53   |    | nC |

### SWITCHING CHARACTERISTICS (Note 4)

|                     |              |   |  |      |  |    |
|---------------------|--------------|---|--|------|--|----|
| Turn-On Delay Time  | $t_{d(ON)}$  | $V_{GS} = 4.5\text{ V}, V_{DS} = 15\text{ V}, I_D = 15\text{ A}, R_G = 3.0\ \Omega$ |  | 18.9 |  | ns |
| Rise Time           | $t_r$        |   |  | 34   |  |    |
| Turn-Off Delay Time | $t_{d(OFF)}$ |   |  | 24.6 |  |    |
| Fall Time           | $t_f$        |   |  | 9.4  |  |    |

- Pulse Test: pulse width  $\leq 300\ \mu\text{s}$ , duty cycle  $\leq 2\%$ .
- Switching characteristics are independent of operating junction temperatures.

# NTMFS4946N

## ELECTRICAL CHARACTERISTICS ( $T_J = 25^\circ\text{C}$ unless otherwise specified)

| Parameter                                 | Symbol       | Test Condition  | Min | Typ  | Max | Unit |
|---|--------------|---|-----|------|-----|------|
| <b>SWITCHING CHARACTERISTICS</b> (Note 4) |              |   |     |      |     |      |
| Turn-On Delay Time                        | $t_{d(ON)}$  | $V_{GS} = 11.5\text{ V}, V_{DS} = 15\text{ V},$<br>$I_D = 15\text{ A}, R_G = 3.0\ \Omega$ |     | 10.7 |     | ns   |
| Rise Time                                 | $t_r$        |   |     | 18.9 |     |      |
| Turn-Off Delay Time                       | $t_{d(OFF)}$ |   |     | 34.2 |     |      |
| Fall Time                                 | $t_f$        |   |     | 7.1  |     |      |

## DRAIN-SOURCE DIODE CHARACTERISTICS

|                         |          |   |                           |  |      |     |    |
|-------------------------|----------|---|---------------------------|--|------|-----|----|
| Forward Diode Voltage   | $V_{SD}$ | $V_{GS} = 0\text{ V},$<br>$I_S = 30\text{ A}$                                     | $T_J = 25^\circ\text{C}$  |  | 0.8  | 1.0 | V  |
|                         |          |   | $T_J = 125^\circ\text{C}$ |  | 0.66 |     |    |
| Reverse Recovery Time   | $t_{RR}$ | $V_{GS} = 0\text{ V}, dI_S/dt = 100\text{ A}/\mu\text{s},$<br>$I_S = 30\text{ A}$ |                           |  | 21.6 |     | ns |
| Charge Time             | $t_a$    |   |                           |  | 11.4 |     |    |
| Discharge Time          | $t_b$    |   |                           |  | 10.2 |     |    |
| Reverse Recovery Charge | $Q_{RR}$ |   |                           |  | 8.5  |     |    |

## PACKAGE PARASITIC VALUES

|                   |       |                          |     |       |     |    |
|-------------------|-------|--------------------------|-----|-------|-----|----|
| Source Inductance | $L_S$ | $T_A = 25^\circ\text{C}$ |     | 0.65  |     | nH |
| Drain Inductance  | $L_D$ |                          |     | 0.005 |     |    |
| Gate Inductance   | $L_G$ |                          |     | 1.84  |     |    |
| Gate Resistance   | $R_G$ |                          | 0.5 | 1.4   | 2.2 |    |

- Pulse Test: pulse width  $\leq 300\ \mu\text{s}$ , duty cycle  $\leq 2\%$ .
- Switching characteristics are independent of operating junction temperatures.

## TYPICAL CHARACTERISTICS

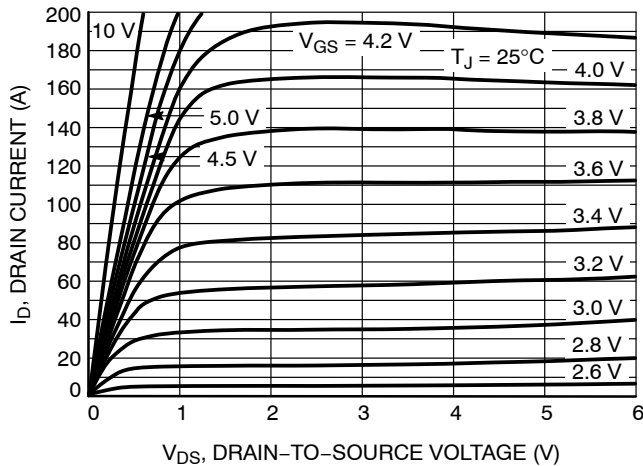

Figure 1. On-Region Characteristics

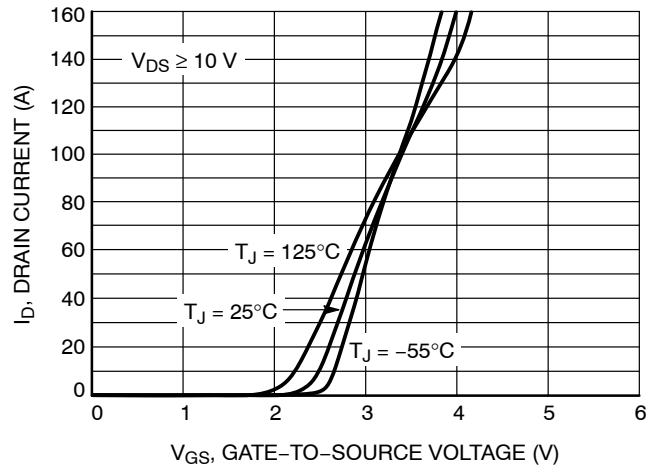
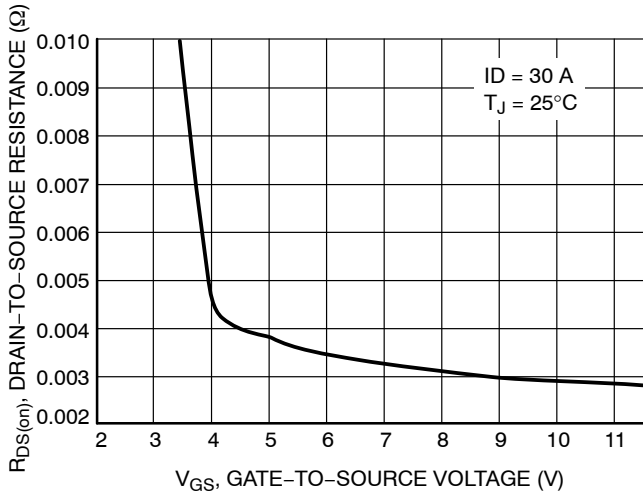

Figure 2. Transfer Characteristics

## TYPICAL CHARACTERISTICS

# NTMFS4946N



**Figure 3. On-Resistance vs. Gate-to-Source Voltage**

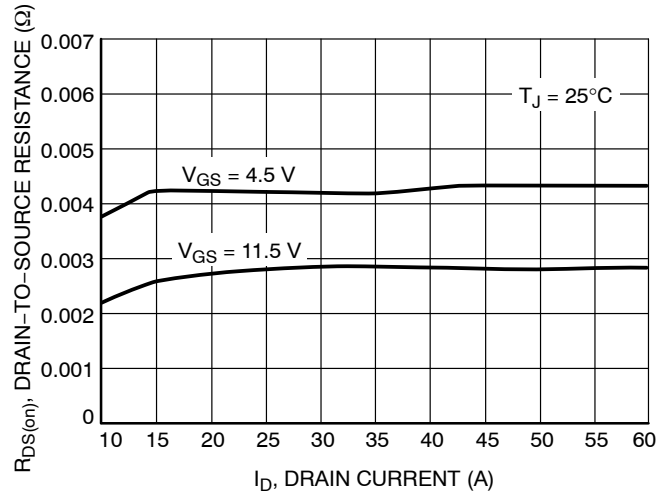

**Figure 4. On-Resistance vs. Drain Current and Gate Voltage**

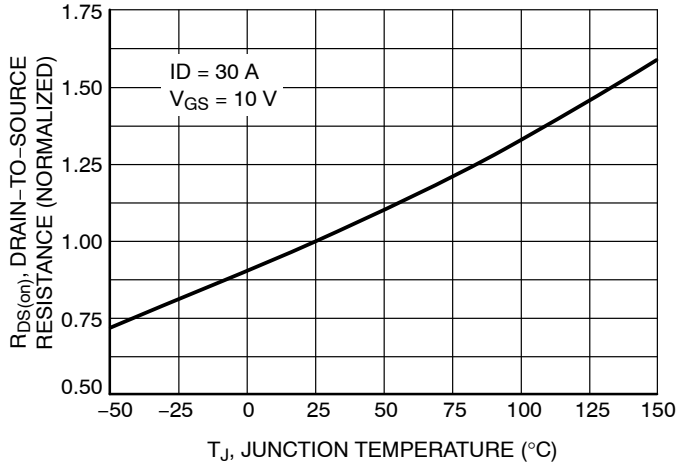

**Figure 5. On-Resistance Variation with Temperature**

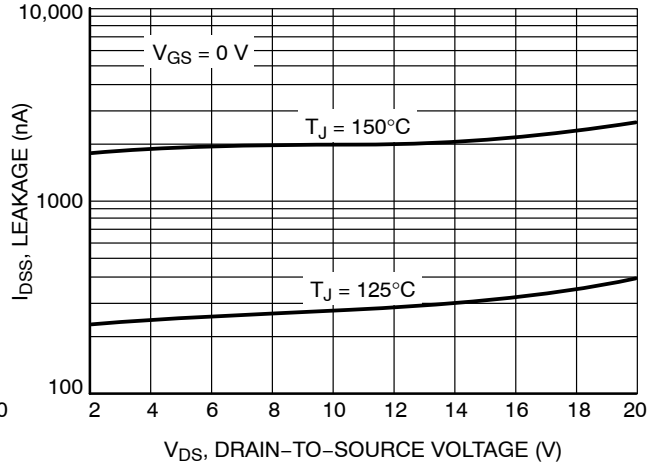

**Figure 6. Drain-to-Source Leakage Current vs. Voltage**

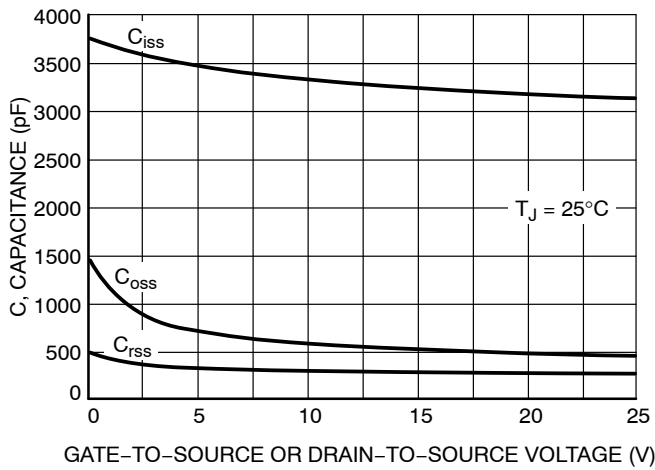

**Figure 7. Capacitance Variation**

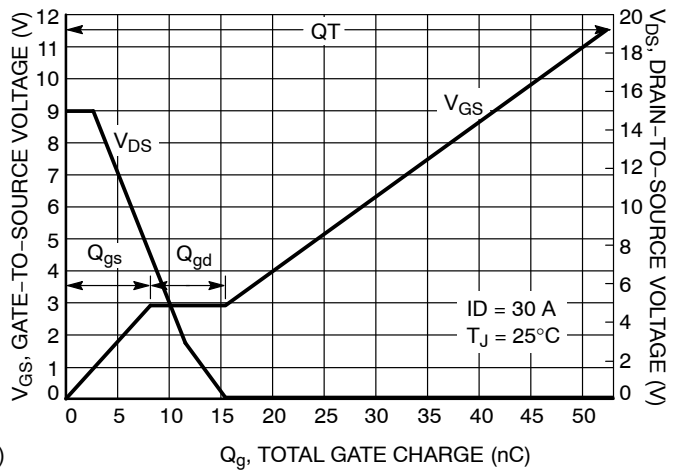

**Figure 8. Gate-to-Source and Drain-to-Source Voltage vs. Total Charge**

TYPICAL CHARACTERISTICS

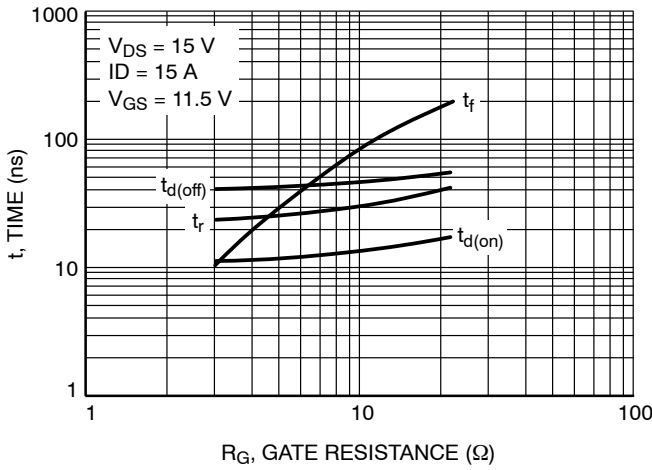

Figure 9. Resistive Switching Time Variation vs. Gate Resistance

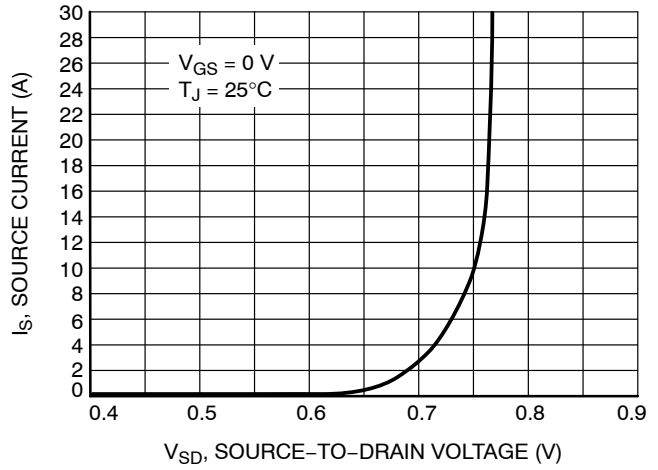

Figure 10. Diode Forward Voltage vs. Current

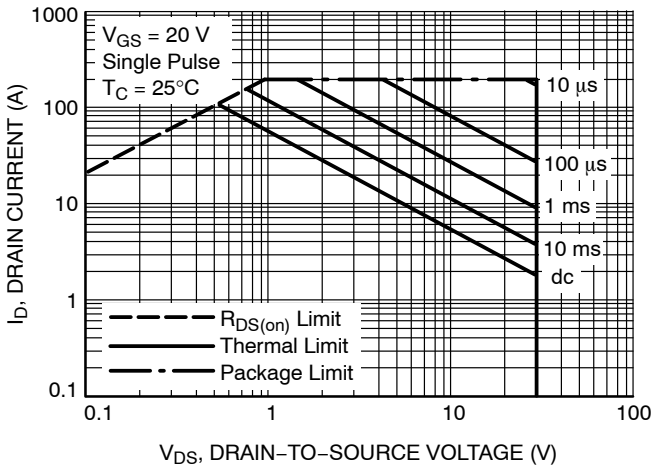

Figure 11. Maximum Rated Forward Biased Safe Operating Area

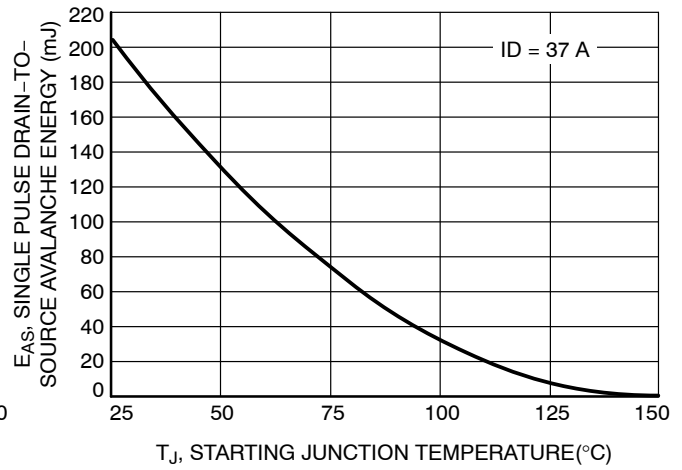

Figure 12. Maximum Avalanche Energy vs. Starting Junction Temperature

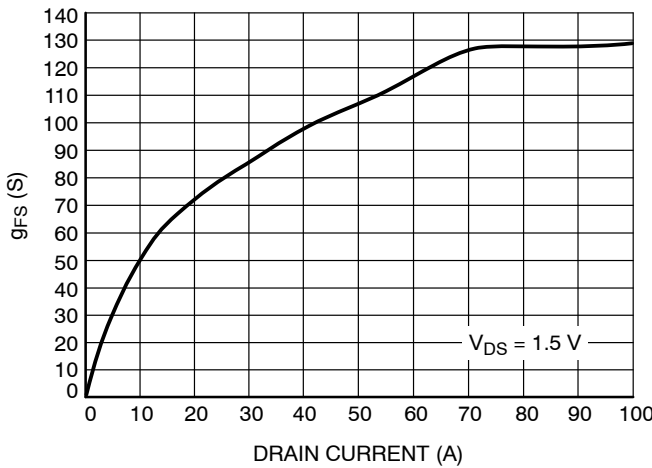

Figure 13.  $g_{FS}$  vs. Drain Current

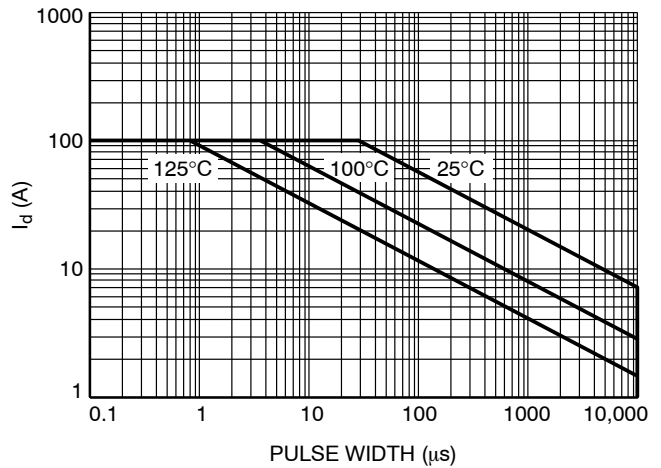

Figure 14.  $I_d$  vs. Pulse Width

# MECHANICAL CASE OUTLINE

## PACKAGE DIMENSIONS



1  
SCALE 2:1

DFN5 5x6, 1.27P  
(SO-8FL)  
CASE 488AA  
ISSUE N

DATE 25 JUN 2018

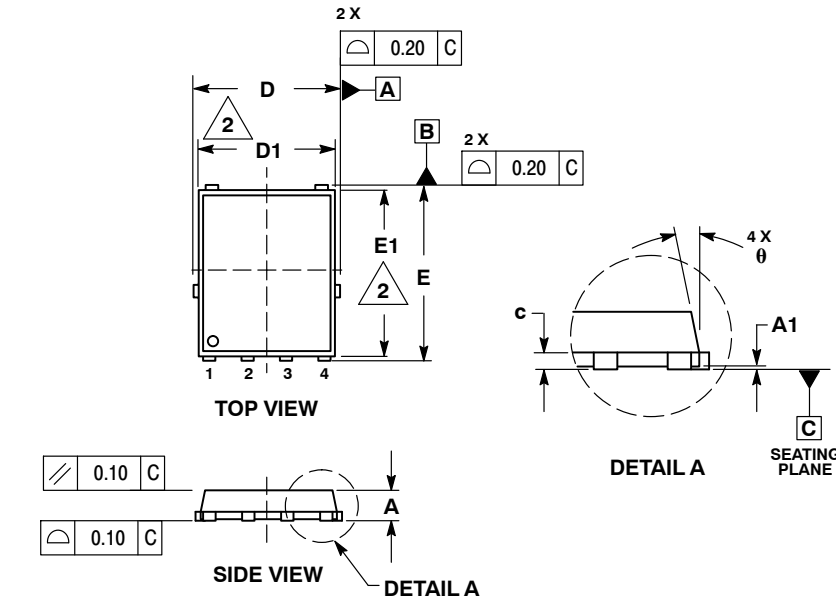

NOTES:

1. DIMENSIONING AND TOLERANCING PER ASME Y14.5M, 1994.
2. CONTROLLING DIMENSION: MILLIMETER.
3. DIMENSION D1 AND E1 DO NOT INCLUDE MOLD FLASH PROTRUSIONS OR GATE BURRS.

| DIM | MILLIMETERS |       |      |
|-----|-------------|-------|------|
|     | MIN         | NOM   | MAX  |
| A   | 0.90        | 1.00  | 1.10 |
| A1  | 0.00        | ---   | 0.05 |
| b   | 0.33        | 0.41  | 0.51 |
| c   | 0.23        | 0.28  | 0.33 |
| D   | 5.00        | 5.15  | 5.30 |
| D1  | 4.70        | 4.90  | 5.10 |
| D2  | 3.80        | 4.00  | 4.20 |
| E   | 6.00        | 6.15  | 6.30 |
| E1  | 5.70        | 5.90  | 6.10 |
| E2  | 3.45        | 3.65  | 3.85 |
| e   | 1.27 BSC    |       |      |
| G   | 0.51        | 0.575 | 0.71 |
| K   | 1.20        | 1.35  | 1.50 |
| L   | 0.51        | 0.575 | 0.71 |
| L1  | 0.125 REF   |       |      |
| M   | 3.00        | 3.40  | 3.80 |
| θ   | 0°          | ---   | 12°  |

### GENERIC MARKING DIAGRAM\*



- XXXXXX = Specific Device Code
- A = Assembly Location
- Y = Year
- W = Work Week
- ZZ = Lot Traceability

\*This information is generic. Please refer to device data sheet for actual part marking. Pb-Free indicator, "G" or microdot "•", may or may not be present. Some products may not follow the Generic Marking.

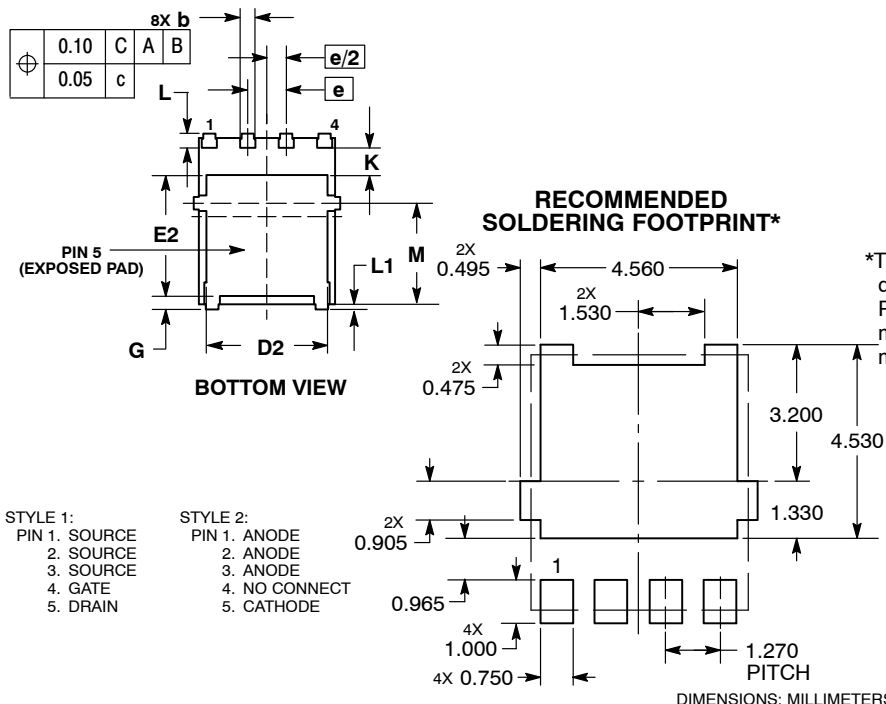

- STYLE 1:  
PIN 1. SOURCE  
2. SOURCE  
3. SOURCE  
4. GATE  
5. DRAIN
- STYLE 2:  
PIN 1. ANODE  
2. ANODE  
3. ANODE  
4. NO CONNECT  
5. CATHODE

DIMENSIONS: MILLIMETERS

\*For additional information on our Pb-Free strategy and soldering details, please download the ON Semiconductor Soldering and Mounting Techniques Reference Manual, SOLDERRM/D.

|                  |                          |  |
|------------------|--------------------------|--|
| DOCUMENT NUMBER: | 98AON14036D              | Electronic versions are uncontrolled except when accessed directly from the Document Repository. Printed versions are uncontrolled except when stamped "CONTROLLED COPY" in red. |
| DESCRIPTION:     | DFN5 5x6, 1.27P (SO-8FL) | PAGE 1 OF 1  |

onsemi and ONSEMI are trademarks of Semiconductor Components Industries, LLC dba onsemi or its subsidiaries in the United States and/or other countries. onsemi reserves the right to make changes without further notice to any products herein. onsemi makes no warranty, representation or guarantee regarding the suitability of its products for any particular purpose, nor does onsemi assume any liability arising out of the application or use of any product or circuit, and specifically disclaims any and all liability, including without limitation special, consequential or incidental damages. onsemi does not convey any license under its patent rights nor the rights of others.

**onsemi**, **Onsemi**, and other names, marks, and brands are registered and/or common law trademarks of Semiconductor Components Industries, LLC dba "**onsemi**" or its affiliates and/or subsidiaries in the United States and/or other countries. **onsemi** owns the rights to a number of patents, trademarks, copyrights, trade secrets, and other intellectual property. A listing of **onsemi**'s product/patent coverage may be accessed at [www.onsemi.com/site/pdf/Patent-Marking.pdf](http://www.onsemi.com/site/pdf/Patent-Marking.pdf). **onsemi** reserves the right to make changes at any time to any products or information herein, without notice. The information herein is provided "as-is" and **onsemi** makes no warranty, representation or guarantee regarding the accuracy of the information, product features, availability, functionality, or suitability of its products for any particular purpose, nor does **onsemi** assume any liability arising out of the application or use of any product or circuit, and specifically disclaims any and all liability, including without limitation special, consequential or incidental damages. Buyer is responsible for its products and applications using **onsemi** products, including compliance with all laws, regulations and safety requirements or standards, regardless of any support or applications information provided by **onsemi**. "Typical" parameters which may be provided in **onsemi** data sheets and/or specifications can and do vary in different applications and actual performance may vary over time. All operating parameters, including "Typicals" must be validated for each customer application by customer's technical experts. **onsemi** does not convey any license under any of its intellectual property rights nor the rights of others. **onsemi** products are not designed, intended, or authorized for use as a critical component in life support systems or any FDA Class 3 medical devices or medical devices with a same or similar classification in a foreign jurisdiction or any devices intended for implantation in the human body. Should Buyer purchase or use **onsemi** products for any such unintended or unauthorized application, Buyer shall indemnify and hold **onsemi** and its officers, employees, subsidiaries, affiliates, and distributors harmless against all claims, costs, damages, and expenses, and reasonable attorney fees arising out of, directly or indirectly, any claim of personal injury or death associated with such unintended or unauthorized use, even if such claim alleges that **onsemi** was negligent regarding the design or manufacture of the part. **onsemi** is an Equal Opportunity/Affirmative Action Employer. This literature is subject to all applicable copyright laws and is not for resale in any manner.

## ADDITIONAL INFORMATION

### TECHNICAL PUBLICATIONS:

Technical Library: [www.onsemi.com/design/resources/technical-documentation](http://www.onsemi.com/design/resources/technical-documentation)  
onsemi Website: [www.onsemi.com](http://www.onsemi.com)

### ONLINE SUPPORT: [www.onsemi.com/support](http://www.onsemi.com/support)

For additional information, please contact your local Sales Representative at [www.onsemi.com/support/sales](http://www.onsemi.com/support/sales)