



Is Now Part of



ON Semiconductor®

To learn more about ON Semiconductor, please visit our website at
www.onsemi.com

Please note: As part of the Fairchild Semiconductor integration, some of the Fairchild orderable part numbers will need to change in order to meet ON Semiconductor's system requirements. Since the ON Semiconductor product management systems do not have the ability to manage part nomenclature that utilizes an underscore (_), the underscore (_) in the Fairchild part numbers will be changed to a dash (-). This document may contain device numbers with an underscore (_). Please check the ON Semiconductor website to verify the updated device numbers. The most current and up-to-date ordering information can be found at www.onsemi.com. Please email any questions regarding the system integration to Fairchild_questions@onsemi.com.

ON Semiconductor and the ON Semiconductor logo are trademarks of Semiconductor Components Industries, LLC dba ON Semiconductor or its subsidiaries in the United States and/or other countries. ON Semiconductor owns the rights to a number of patents, trademarks, copyrights, trade secrets, and other intellectual property. A listing of ON Semiconductor's product/patent coverage may be accessed at www.onsemi.com/site/pdf/Patent-Marking.pdf. ON Semiconductor reserves the right to make changes without further notice to any products herein. ON Semiconductor makes no warranty, representation or guarantee regarding the suitability of its products for any particular purpose, nor does ON Semiconductor assume any liability arising out of the application or use of any product or circuit, and specifically disclaims any and all liability, including without limitation special, consequential or incidental damages. Buyer is responsible for its products and applications using ON Semiconductor products, including compliance with all laws, regulations and safety requirements or standards, regardless of any support or applications information provided by ON Semiconductor. "Typical" parameters which may be provided in ON Semiconductor data sheets and/or specifications can and do vary in different applications and actual performance may vary over time. All operating parameters, including "Typicals" must be validated for each customer application by customer's technical experts. ON Semiconductor does not convey any license under its patent rights nor the rights of others. ON Semiconductor products are not designed, intended, or authorized for use as a critical component in life support systems or any FDA Class 3 medical devices or medical devices with a same or similar classification in a foreign jurisdiction or any devices intended for implantation in the human body. Should Buyer purchase or use ON Semiconductor products for any such unintended or unauthorized application, Buyer shall indemnify and hold ON Semiconductor and its officers, employees, subsidiaries, affiliates, and distributors harmless against all claims, costs, damages, and expenses, and reasonable attorney fees arising out of, directly or indirectly, any claim of personal injury or death associated with such unintended or unauthorized use, even if such claim alleges that ON Semiconductor was negligent regarding the design or manufacture of the part. ON Semiconductor is an Equal Opportunity/Affirmative Action Employer. This literature is subject to all applicable copyright laws and is not for resale in any manner.

MM74HCT540, Inverting Octal 3-STATE Buffer MM74HCT541, Octal 3-STATE Buffer

Features

- TTL input compatible
- Typical propagation delay: 12ns
- 3-STATE outputs for connection to system buses
- Low quiescent current: 80µA
- Output current: 6mA (Min.)

General Description

The MM74HCT540 and MM74HCT541 3-STATE buffers utilize advanced silicon-gate CMOS technology and are general purpose high speed inverting and non-inverting buffers. They possess high drive current outputs which enable high speed operation even when driving large bus capacitances. These circuits achieve speeds comparable to low power Schottky devices, while retaining the low power consumption of CMOS. Both devices are TTL input compatible and have a fanout of 15 LS-TTL equivalent inputs.

MM74HCT devices are intended to interface between TTL and NMOS components and standard CMOS devices. These parts are also plug-in replacements for LS-TTL devices and can be used to reduce power consumption in existing designs.

The MM74HCT540 is an inverting buffer and the MM74HCT541 is a non-inverting buffer. The 3-STATE control gate operates as a two-input NOR such that if either $\overline{G1}$ or $\overline{G2}$ are HIGH, all eight outputs are in the high-impedance state.

In order to enhance PC board layout, the MM74HCT540 and MM74HCT541 offers a pinout having inputs and outputs on opposite sides of the package. All inputs are protected from damage due to static discharge by diodes to V_{CC} and ground.

Ordering Information

Order Number	Package Number	Package Description
MM74HCT540WM	M20B	20-Lead Small Outline Integrated Circuit (SOIC), JEDEC MS-013, 0.300" Wide
MM74HCT540SJ	M20D	20-Lead Small Outline Package (SOP), EIAJ TYPE II, 5.3mm Wide
MM74HCT540MTC	MTC20	20-Lead Thin Shrink Small Outline Package (TSSOP), JEDEC MO-153, 4.4mm Wide
MM74HCT541WM	M20B	20-Lead Small Outline Integrated Circuit (SOIC), JEDEC MS-013, 0.300" Wide
MM74HCT541SJ	M20D	20-Lead Small Outline Package (SOP), EIAJ TYPE II, 5.3mm Wide
MM74HCT541MTC	MTC20	20-Lead Thin Shrink Small Outline Package (TSSOP), JEDEC MO-153, 4.4mm Wide
MM74HCT541N	N20A	20-Lead Plastic Dual-In-Line Package (PDIP), JEDEC MS-001, 0.300" Wide

Devices also available in Tape and Reel. Specify by appending the suffix letter "X" to the ordering number.

Connection Diagrams

Pin Assignments for DIP, SOIC, SOP and TSSOP

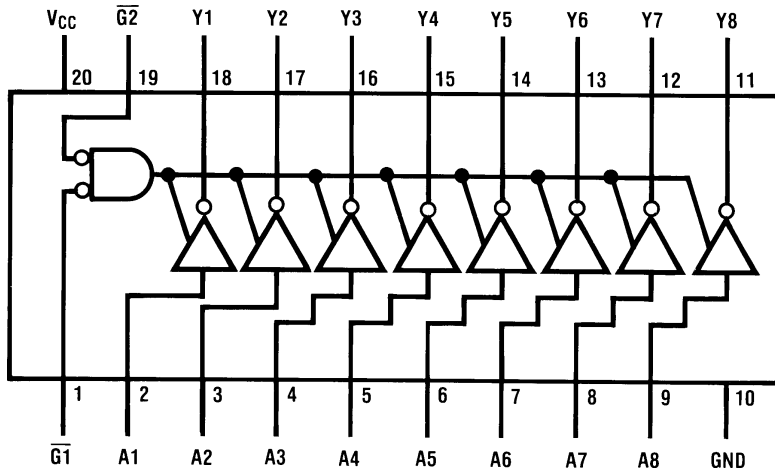

Top View, MM74HCT540

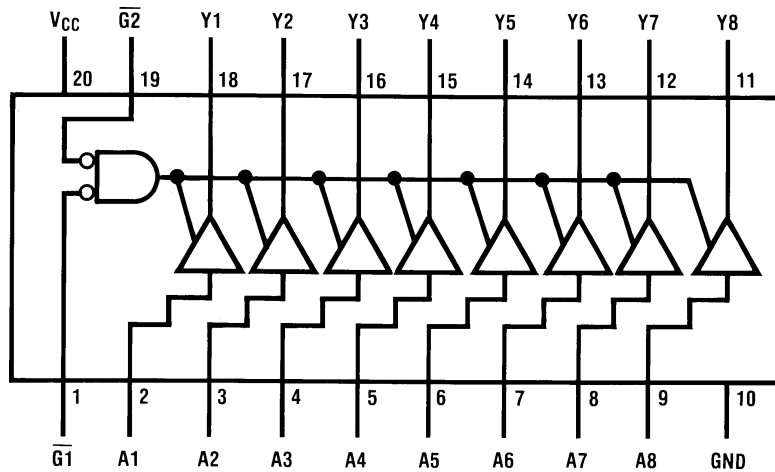

Top View, MM74HCT541

Absolute Maximum Ratings⁽¹⁾

Stresses exceeding the absolute maximum ratings may damage the device. The device may not function or be operable above the recommended operating conditions and stressing the parts to these levels is not recommended. In addition, extended exposure to stresses above the recommended operating conditions may affect device reliability. The absolute maximum ratings are stress ratings only.

Symbol	Parameter	Rating
V_{CC}	Supply Voltage	-0.5 to +7.0V
V_{IN}	DC Input Voltage	-1.5 to $V_{CC} + 1.5V$
V_{OUT}	DC Output Voltage	-0.5 to $V_{CC} + 0.5V$
I_{IK}, I_{OK}	Clamp Diode Current	$\pm 20mA$
I_{OUT}	DC Output Current, per pin	$\pm 35mA$
I_{CC}	DC V_{CC} or GND Current, per pin	$\pm 70mA$
T_{STG}	Storage Temperature Range	-65°C to +150°C
P_D	Power Dissipation Note 2 S.O. Package only	600mW 500mW
T_L	Lead Temperature (Soldering 10 seconds)	260°C

Note:

1. Unless otherwise specified all voltages are referenced to ground.
2. Power Dissipation temperature derating — plastic "N" package: -12mW/°C from 65°C to 85°C.

Recommended Operating Conditions

The Recommended Operating Conditions table defines the conditions for actual device operation. Recommended operating conditions are specified to ensure optimal performance to the datasheet specifications. Fairchild does not recommend exceeding them or designing to absolute maximum ratings.

Symbol	Parameter	Min.	Max.	Units
V_{CC}	Supply Voltage	4.5	5.5	V
V_{IN}, V_{OUT}	DC Input or Output Voltage	0	V_{CC}	V
T_A	Operating Temperature Range	-40	+85	°C
t_r, t_f	Input Rise and Fall Times		500	ns

DC Electrical Characteristics $V_{CC} = 5V \pm 10\%$ (unless otherwise specified)

Symbol	Parameter	Conditions	$T_A = 25^\circ\text{C}$		$T_A = -40$	$T_A = -55$	Units
			Typ.	Guaranteed Limits		to 85°C	
V_{IH}	Minimum HIGH Level Input Voltage			2.0	2.0	2.0	V
V_{IL}	Maximum LOW Level Input Voltage			0.8	0.8	0.8	V
V_{OH}	Minimum HIGH Level Output Voltage	$V_{IN} = V_{IH}$ or V_{IL} : $ I_{OUT} = 20\mu\text{A}$	V_{CC}	$V_{CC} - 0.1$	$V_{CC} - 0.1$	$V_{CC} - 0.1$	V
		$ I_{OUT} = 6.0\text{mA}$, $V_{CC} = 4.5\text{V}$	4.2	3.98	3.84	3.7	
		$ I_{OUT} = 7.2\text{mA}$, $V_{CC} = 5.5\text{V}$	5.2	4.98	4.84	4.7	
V_{OL}	Maximum LOW Level Voltage	$V_{IN} = V_{IH}$ or V_{IL} : $ I_{OUT} = 20\mu\text{A}$	0	0.1	0.1	0.1	V
		$ I_{OUT} = 6.0\text{mA}$, $V_{CC} = 4.5\text{V}$	0.2	0.26	0.33	0.4	
		$ I_{OUT} = 7.2\text{mA}$, $V_{CC} = 5.5\text{V}$	0.2	0.26	0.33	0.4	
I_{IN}	Maximum Input Current	$V_{IN} = V_{CC}$ or GND		± 0.1	± 1.0	± 1.0	μA
I_{OZ}	Maximum 3-STATE Output Leakage Current	$V_{OUT} = V_{CC}$ or GND, $\overline{G} = V_{IH}$		± 0.5	± 5.0	± 10	μA
I_{CC}	Maximum Quiescent Supply Current	$V_{IN} = V_{CC}$ or GND, $I_{OUT} = 0\mu\text{A}$		8.0	80	160	μA
		$V_{IN} = 2.4\text{V}$ or $0.5\text{V}^{(3)}$	0.6	1.0	1.3	1.5	mA

Note:3. Measured per input. All other inputs at V_{CC} or GND.

AC Electrical CharacteristicsMM74HCT540: $V_{CC} = 5.0V$, $t_r = t_f = 6ns$, $T_A = 25^\circ C$, (unless otherwise specified).

Symbol	Parameter	Conditions	Typ.	Guaranteed Limits	Units
t_{PHL} , t_{PLH}	Maximum Output Propagation Delay	$C_L = 45pF$	12	18	ns
t_{PZL} , t_{PZH}	Maximum Output Enable Time	$C_L = 45pF$, $R_L = 1k\Omega$	14	28	ns
t_{PLZ} , t_{PHZ}	Maximum Output Disable Time	$C_L = 5pF$, $R_L = 1k\Omega$	13	25	ns

AC Electrical CharacteristicsMM74HCT540: $V_{CC} = 5.0V \pm 10\%$, $t_r = t_f = 6ns$ (unless otherwise specified).

Symbol	Parameter	Conditions	$T_A = 25^\circ C$		$T_A = -40$ to $85^\circ C$	$T_A = -55$ to $125^\circ C$	Units	
			Typ.	Guaranteed Limits				
t_{PHL} , t_{PLH}	Maximum Output Propagation Delay	$C_L = 50pF$	12	20	25	30	ns	
		$C_L = 150pF$	22	30	38	45		
t_{PZH} , t_{PZL}	Maximum Output Enable Time	$R_L = 1k\Omega$	$C_L = 50pF$	15	30	38	45	ns
			$C_L = 150pF$	20	40	50	60	
t_{PHZ} , t_{PLZ}	Maximum Output Disable Time	$R_L = 1k\Omega$, $C_L = 50pF$	15	30	38	45	ns	
t_{THL} , t_{TLH}	Maximum Output Rise and Fall Time	$C_L = 50pF$	6	12	15	18	ns	
C_{IN}	Maximum Input Capacitance		5	10	10	10	pF	
C_{OUT}	Maximum Output Capacitance		15	20	20	20	pF	
C_{PD}	Power Dissipation Capacitance ⁽⁴⁾	(per output)	$\overline{G} = V_{CC}$	12			pF	
			$\overline{G} = GND$	50				

Note:

4. C_{PD} determines the no load dynamic power consumption, $P_D = C_{PD} V_{CC}^2 f + I_{CC} V_{CC}$, and the no load dynamic current consumption, $I_S = C_{PD} V_{CC} f + I_{CC}$.

AC Electrical CharacteristicsMM74HCT541: $V_{CC} = 5.0V$, $t_r = t_f = 6ns$, $T_A = 25^\circ C$, (unless otherwise specified).

Symbol	Parameter	Conditions	Typ.	Guaranteed Limits	Units
t_{PHL} , t_{PLH}	Maximum Output Propagation Delay	$C_L = 45pF$	13	20	ns
t_{PZL} , t_{PZH}	Maximum Output Enable Time	$C_L = 45pF$, $R_L = 1k\Omega$	17	28	ns
t_{PLZ} , t_{PHZ}	Maximum Output Disable Time	$C_L = 5pF$, $R_L = 1k\Omega$	15	25	ns

AC Electrical CharacteristicsMM74HCT541: $V_{CC} = 5.0V \pm 10\%$, $t_r = t_f = 6ns$ (unless otherwise specified).

Symbol	Parameter	Conditions	$T_A = 25^\circ C$		$T_A = -40$ to $85^\circ C$	$T_A = -55$ to $125^\circ C$	Units	
			Typ.	Guaranteed Limits				
t_{PHL} , t_{PLH}	Maximum Output Propagation Delay	$C_L = 50pF$	14	23	29	34	ns	
		$C_L = 150pF$	17	33	42	49		
t_{PZH} , t_{PZL}	Maximum Output Enable Time	$R_L = 1k\Omega$	$C_L = 50pF$	17	30	38	45	ns
			$C_L = 150pF$	22	40	50	60	
t_{PHZ} , t_{PLZ}	Maximum Output Disable Time	$R_L = 1k\Omega$, $C_L = 50pF$	17	30	38	45	ns	
t_{THL} , t_{TLH}	Maximum Output Rise and Fall Time	$C_L = 50pF$	6	12	15	18	ns	
C_{IN}	Maximum Input Capacitance		5	10	10	10	pF	
C_{OUT}	Maximum Output Capacitance		15	20	20	20	pF	
C_{PD}	Power Dissipation Capacitance ⁽⁵⁾	(per output)	$\bar{G} = V_{CC}$	12			pF	
			$\bar{G} = GND$	45				

Note:

5. C_{PD} determines the no load dynamic power consumption, $P_D = C_{PD} V_{CC}^2 f + I_{CC} V_{CC}$, and the no load dynamic current consumption, $I_S = C_{PD} V_{CC} f + I_{CC}$.

Physical Dimensions

Dimensions are in inches (millimeters) unless otherwise noted.

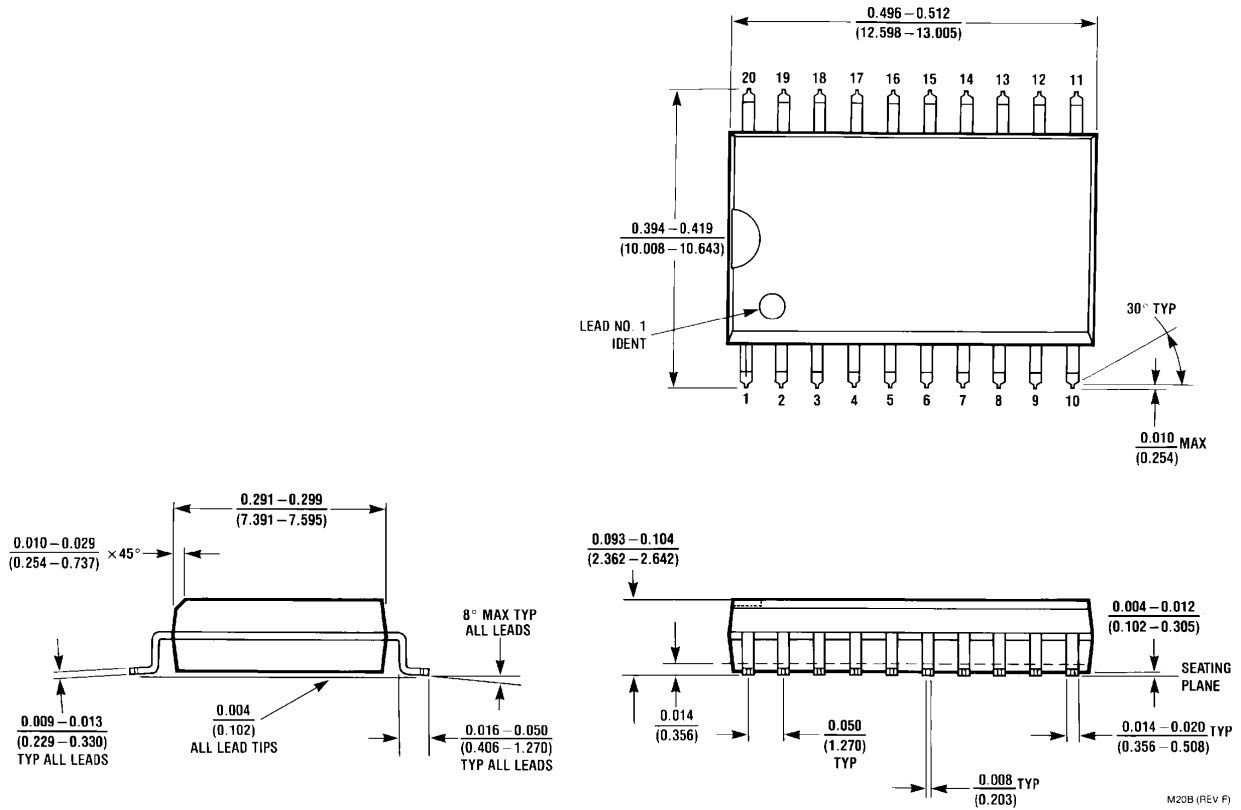
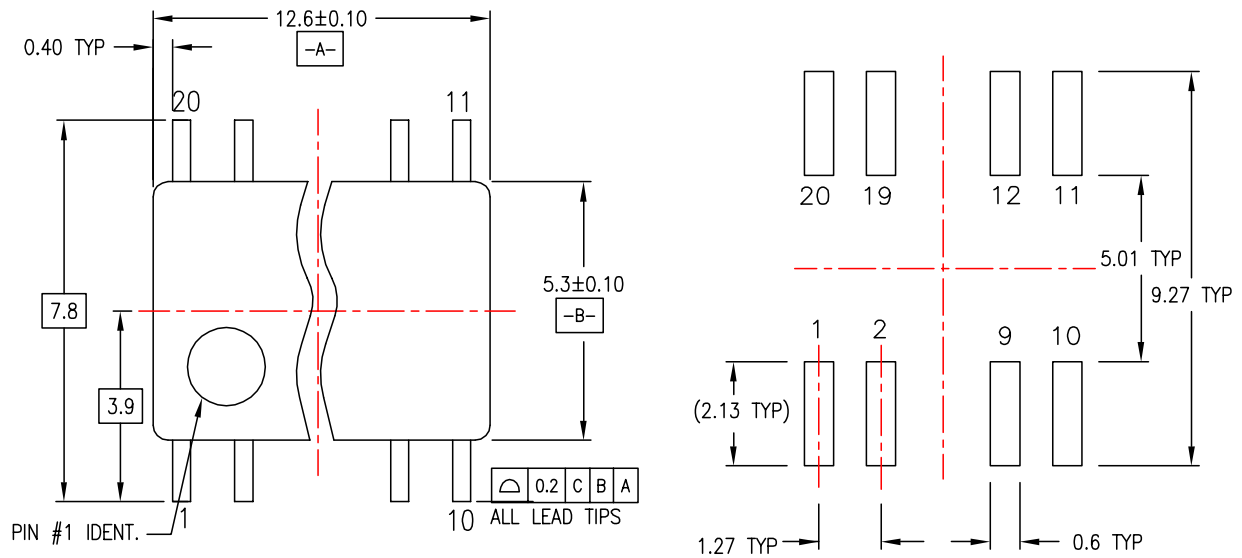

Figure 1. 20-Lead Small Outline Integrated Circuit (SOIC), JEDEC MS-013, 0.300" Wide Package Number M20B

Physical Dimensions (Continued)

Dimensions are in millimeters unless otherwise noted.



LAND PATTERN RECOMMENDATION

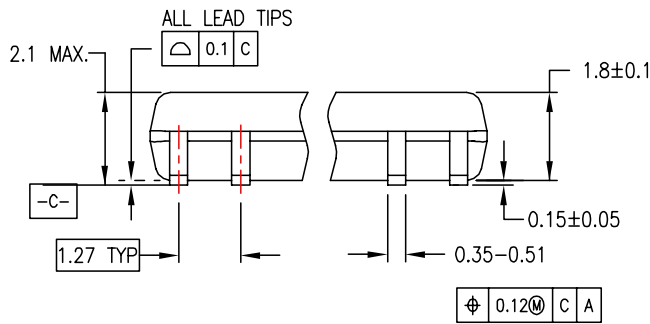

DIMENSIONS ARE IN MILLIMETERS

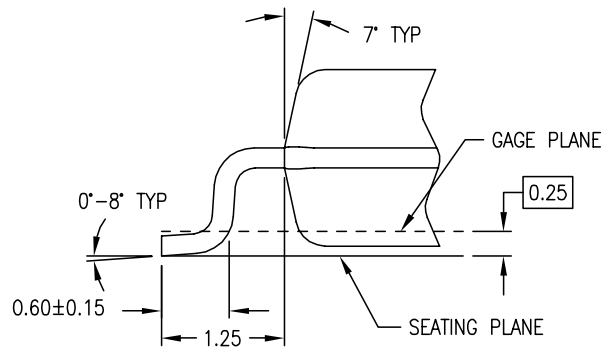
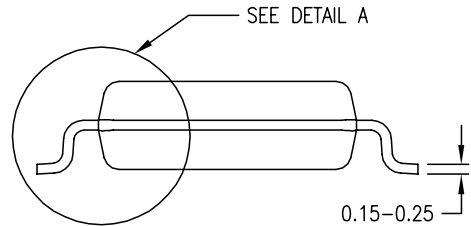

DETAIL A

NOTES:

- A. CONFORMS TO EIAJ EDR-7320 REGISTRATION, ESTABLISHED IN DECEMBER, 1998.
- B. DIMENSIONS ARE IN MILLIMETERS.
- C. DIMENSIONS ARE EXCLUSIVE OF BURRS, MOLD FLASH, AND TIE BAR EXTRUSIONS.

M20DREV C

Figure 2. 20-Lead Small Outline Package (SOP), EIAJ TYPE II, 5.3mm Wide Package Number M20D

Physical Dimensions (Continued)

Dimensions are in inches (millimeters) unless otherwise noted.

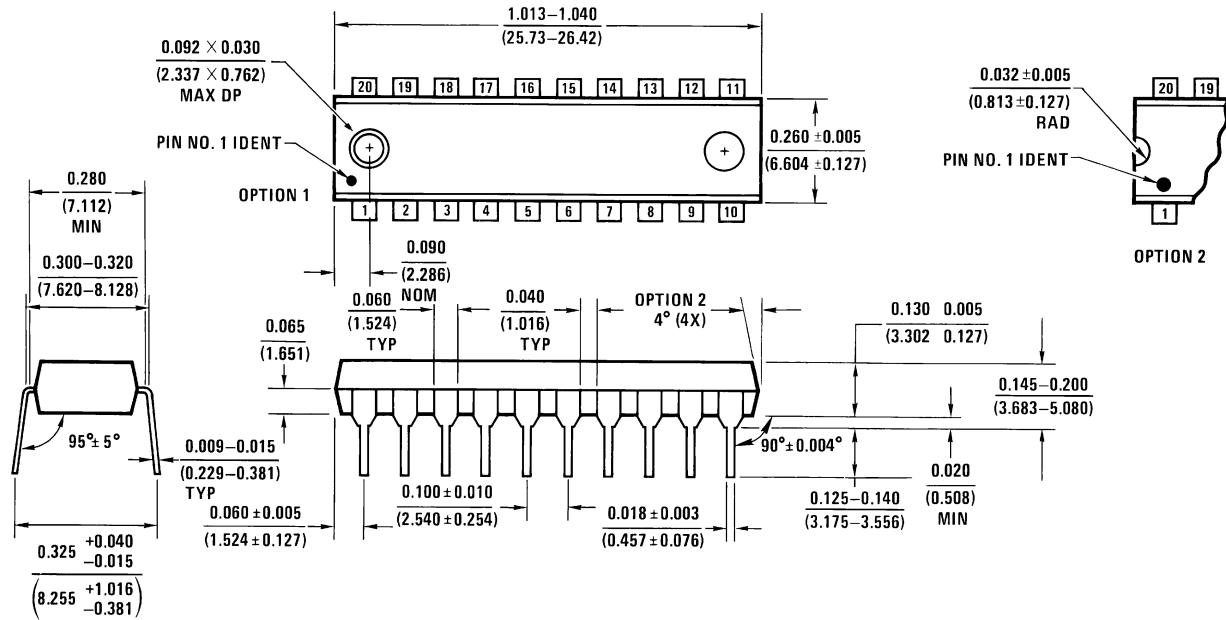

N20A (REV G)

Figure 4. 20-Lead Plastic Dual-In-Line Package (PDIP), JEDEC MS-001, 0.300" Wide Package Number N20A

TRADEMARKS

The following are registered and unregistered trademarks and service marks Fairchild Semiconductor owns or is authorized to use and is not intended to be an exhaustive list of all such trademarks

ACEx®	Green FPS™ e-Series™	Power-SPM™	SyncFET™
Build it Now™	GTO™	PowerTrench®	The Power Franchise®
CorePLUS™	<i>i-Lo</i> ™	Programmable Active Droop™	 ™
CROSSVOLT™	IntelliMAX™	QFET®	TinyBoost™
CTL™	ISOPLANAR™	QS™	TinyBuck™
Current Transfer Logic™	MegaBuck™	QT Optoelectronics™	TinyLogic®
EcoSPARK®	MICROCOUPLER™	Quiet Series™	TINYOPTO™
FACT Quiet Series™	MicroPak™	RapidConfigure™	TinyPower™
FACT®	Motion-SPM™	SMART START™	TinyPWM™
FAST®	OPTOLOGIC®	SPM®	TinyWire™
FastvCore™	OPTOPLANAR®	STEALTH™	μSerDes™
FPS™	PDP-SPM™	SuperFET™	UHC®
FRFET®	Power220®	SuperSOT™-3	UniFET™
Global Power Resource™	Power247®	SuperSOT™-6	VCX™
Green FPS™	POWEREDGE®	SuperSOT™-8	

DISCLAIMER

FAIRCHILD SEMICONDUCTOR RESERVES THE RIGHT TO MAKE CHANGES WITHOUT FURTHER NOTICE TO ANY PRODUCTS HEREIN TO IMPROVE RELIABILITY, FUNCTION, OR DESIGN. FAIRCHILD DOES NOT ASSUME ANY LIABILITY ARISING OUT OF THE APPLICATION OR USE OF ANY PRODUCT OR CIRCUIT DESCRIBED HEREIN; NEITHER DOES IT CONVEY ANY LICENSE UNDER ITS PATENT RIGHTS, NOR THE RIGHTS OF OTHERS. THESE SPECIFICATIONS DO NOT EXPAND THE TERMS OF FAIRCHILD'S WORLDWIDE TERMS AND CONDITIONS, SPECIFICALLY THE WARRANTY THEREIN, WHICH COVERS THESE PRODUCTS.

LIFE SUPPORT POLICY

FAIRCHILD'S PRODUCTS ARE NOT AUTHORIZED FOR USE AS CRITICAL COMPONENTS IN LIFE SUPPORT DEVICES OR SYSTEMS WITHOUT THE EXPRESS WRITTEN APPROVAL OF FAIRCHILD SEMICONDUCTOR CORPORATION.

As used herein:

- Life support devices or systems are devices or systems which, (a) are intended for surgical implant into the body, or (b) support or sustain life, and (c) whose failure to perform when properly used in accordance with instructions for use provided in the labeling, can be reasonably expected to result in significant injury to the user.
- A critical component is any component of a life support device or system whose failure to perform can be reasonably expected to cause the failure of the life support device or system, or to affect its safety or effectiveness.

PRODUCT STATUS DEFINITIONS

Definition of Terms

Datasheet Identification	Product Status	Definition
Advance Information	Formative or In Design	This datasheet contains the design specifications for product development. Specifications may change in any manner without notice.
Preliminary	First Production	This datasheet contains preliminary data; supplementary data will be published at a later date. Fairchild Semiconductor reserves the right to make changes at any time without notice to improve design.
No Identification Needed	Full Production	This datasheet contains final specifications. Fairchild Semiconductor reserves the right to make changes at any time without notice to improve design.
Obsolete	Not In Production	This datasheet contains specifications on a product that has been discontinued by Fairchild semiconductor. The datasheet is printed for reference information only.

Rev. I28

ON Semiconductor and  are trademarks of Semiconductor Components Industries, LLC dba ON Semiconductor or its subsidiaries in the United States and/or other countries. ON Semiconductor owns the rights to a number of patents, trademarks, copyrights, trade secrets, and other intellectual property. A listing of ON Semiconductor's product/patent coverage may be accessed at www.onsemi.com/site/pdf/Patent-Marking.pdf. ON Semiconductor reserves the right to make changes without further notice to any products herein. ON Semiconductor makes no warranty, representation or guarantee regarding the suitability of its products for any particular purpose, nor does ON Semiconductor assume any liability arising out of the application or use of any product or circuit, and specifically disclaims any and all liability, including without limitation special, consequential or incidental damages. Buyer is responsible for its products and applications using ON Semiconductor products, including compliance with all laws, regulations and safety requirements or standards, regardless of any support or applications information provided by ON Semiconductor. "Typical" parameters which may be provided in ON Semiconductor data sheets and/or specifications can and do vary in different applications and actual performance may vary over time. All operating parameters, including "Typicals" must be validated for each customer application by customer's technical experts. ON Semiconductor does not convey any license under its patent rights nor the rights of others. ON Semiconductor products are not designed, intended, or authorized for use as a critical component in life support systems or any FDA Class 3 medical devices or medical devices with a same or similar classification in a foreign jurisdiction or any devices intended for implantation in the human body. Should Buyer purchase or use ON Semiconductor products for any such unintended or unauthorized application, Buyer shall indemnify and hold ON Semiconductor and its officers, employees, subsidiaries, affiliates, and distributors harmless against all claims, costs, damages, and expenses, and reasonable attorney fees arising out of, directly or indirectly, any claim of personal injury or death associated with such unintended or unauthorized use, even if such claim alleges that ON Semiconductor was negligent regarding the design or manufacture of the part. ON Semiconductor is an Equal Opportunity/Affirmative Action Employer. This literature is subject to all applicable copyright laws and is not for resale in any manner.

PUBLICATION ORDERING INFORMATION

LITERATURE FULFILLMENT:

Literature Distribution Center for ON Semiconductor
19521 E. 32nd Pkwy, Aurora, Colorado 80011 USA
Phone: 303-675-2175 or 800-344-3860 Toll Free USA/Canada
Fax: 303-675-2176 or 800-344-3867 Toll Free USA/Canada
Email: orderlit@onsemi.com

N. American Technical Support: 800-282-9855 Toll Free
USA/Canada
Europe, Middle East and Africa Technical Support:
Phone: 421 33 790 2910
Japan Customer Focus Center
Phone: 81-3-5817-1050

ON Semiconductor Website: www.onsemi.com
Order Literature: <http://www.onsemi.com/orderlit>
For additional information, please contact your local
Sales Representative