

# MC74AC240, MC74ACT240

## Octal Buffer/Line Driver with 3-State Outputs

The MC74AC240/74ACT240 is an octal buffer and line driver designed to be employed as a memory address driver, clock driver and bus oriented transmitter or receiver which provides improved PC board density.

### Features

- 3-State Outputs Drive Bus Lines or Buffer Memory Address Registers
- Outputs Source/Sink 24 mA
- 'ACT240 Has TTL Compatible Inputs
- These are Pb-Free Devices

### TRUTH TABLE

Inputs		Outputs
$\overline{OE}_1$	D	(Pins 12, 14, 16, 18)
L	L	H
L	H	L
H	X	Z

NOTE: H = HIGH Voltage Level  
L = LOW Voltage Level  
X = Immaterial  
Z = High Impedance

### TRUTH TABLE

Inputs		Outputs
$\overline{OE}_2$	D	(Pins 3, 5, 7, 9)
L	L	H
L	H	L
H	X	Z

NOTE: H = HIGH Voltage Level  
L = LOW Voltage Level  
X = Immaterial  
Z = High Impedance



**ON Semiconductor®**

[www.onsemi.com](http://www.onsemi.com)

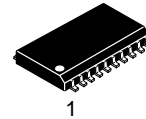

SOIC-20W  
DW SUFFIX  
CASE 751D

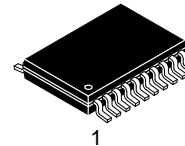

TSSOP-20  
DT SUFFIX  
CASE 948E

### ORDERING INFORMATION

See detailed ordering and shipping information in the package dimensions section on page 6 of this data sheet.

### DEVICE MARKING INFORMATION

See general marking information in the device marking section on page 7 of this data sheet.

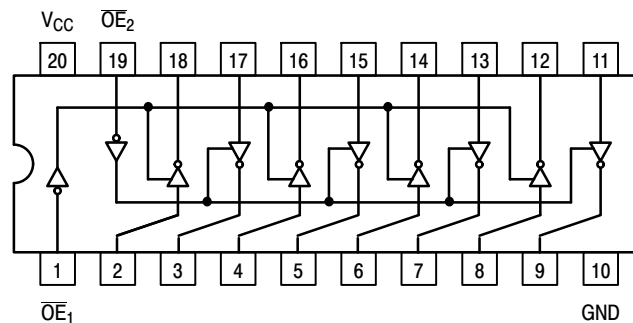

Figure 1. Pinout: 20-Lead Packages Conductors

(Top View)

# MC74AC240, MC74ACT240

## MAXIMUM RATINGS

Symbol	Parameter	Value	Unit
V <sub>CC</sub>	DC Supply Voltage (Referenced to GND)	-0.5 to +7.0	V
V <sub>IN</sub>	DC Input Voltage (Referenced to GND)	-0.5 to V <sub>CC</sub> +0.5	V
V <sub>OUT</sub>	DC Output Voltage (Referenced to GND) (Note 1)	-0.5 to V <sub>CC</sub> +0.5	V
I <sub>IK</sub>	DC Input Diode Current	±20	mA
I <sub>OK</sub>	DC Output Diode Current	±50	mA
I <sub>OUT</sub>	DC Output Sink/Source Current	±50	mA
I <sub>CC</sub>	DC Supply Current, per Output Pin	±50	mA
I <sub>GND</sub>	DC Ground Current, per Output Pin	±100	mA
T <sub>STG</sub>	Storage Temperature Range	-65 to +150	°C
T <sub>L</sub>	Lead temperature, 1 mm from Case for 10 Seconds	260	°C
T <sub>J</sub>	Junction Temperature Under Bias	140	°C
θ <sub>JA</sub>	Thermal Resistance (Note 2)	SOIC TSSOP 65.8 110.7	°C/W
MSL	Moisture Sensitivity	Level 1	
F <sub>R</sub>	Flammability Rating	Oxygen Index: 30% – 35% UL 94 V-0 @ 0.125 in	
V <sub>ESD</sub>	ESD Withstand Voltage	Human Body Model (Note 3) Machine Model (Note 4) Charged Device Model (Note 5) > 2000 > 200 > 1000	V
I <sub>Latchup</sub>	Latchup Performance	Above V <sub>CC</sub> and Below GND at 85°C (Note 6)	±100 mA

Stresses exceeding those listed in the Maximum Ratings table may damage the device. If any of these limits are exceeded, device functionality should not be assumed, damage may occur and reliability may be affected.

1. I<sub>O</sub> absolute maximum rating must be observed.
2. The package thermal impedance is calculated in accordance with JESD 51-7.
3. Tested to EIA/JESD22-A114-A.
4. Tested to EIA/JESD22-A115-A.
5. Tested to JESD22-C101-A.
6. Tested to EIA/JESD78.

## RECOMMENDED OPERATING CONDITIONS

Symbol	Parameter	Min	Typ	Max	Unit	
V <sub>CC</sub>	Supply Voltage	'AC	2.0	5.0	6.0	V
		'ACT	4.5	5.0	5.5	
V <sub>IN</sub> , V <sub>OUT</sub>	DC Input Voltage, Output Voltage (Ref. to GND)	0	-	V <sub>CC</sub>	V	
t <sub>r</sub> , t <sub>f</sub>	Input Rise and Fall Time (Note 7) 'AC Devices except Schmitt Inputs	V <sub>CC</sub> @ 3.0 V	-	150	-	ns/V
		V <sub>CC</sub> @ 4.5 V	-	40	-	
		V <sub>CC</sub> @ 5.5 V	-	25	-	
t <sub>r</sub> , t <sub>f</sub>	Input Rise and Fall Time (Note 8) 'ACT Devices except Schmitt Inputs	V <sub>CC</sub> @ 4.5 V	-	10	-	ns/V
		V <sub>CC</sub> @ 5.5 V	-	8.0	-	
T <sub>A</sub>	Operating Ambient Temperature Range	-40	25	85	°C	
I <sub>OH</sub>	Output Current – High	-	-	-24	mA	
I <sub>OL</sub>	Output Current – Low	-	-	24	mA	

Functional operation above the stresses listed in the Recommended Operating Ranges is not implied. Extended exposure to stresses beyond the Recommended Operating Ranges limits may affect device reliability.

7. V<sub>IN</sub> from 30% to 70% V<sub>CC</sub>; see individual Data Sheets for devices that differ from the typical input rise and fall times.
8. V<sub>IN</sub> from 0.8 V to 2.0 V; see individual Data Sheets for devices that differ from the typical input rise and fall times.

# MC74AC240, MC74ACT240

## DC CHARACTERISTICS

Symbol	Parameter	V <sub>CC</sub> (V)	74AC		74AC		Unit	Conditions
			T <sub>A</sub> = +25°C		T <sub>A</sub> = -40°C to +85°C			
			Typ	Guaranteed Limits				
V <sub>IH</sub>	Minimum High Level Input Voltage	3.0	1.5	2.1	2.1		V	V <sub>OUT</sub> = 0.1 V or V <sub>CC</sub> - 0.1 V
		4.5	2.25	3.15	3.15			
		5.5	2.75	3.85	3.85			
V <sub>IL</sub>	Maximum Low Level Input Voltage	3.0	1.5	0.9	0.9		V	V <sub>OUT</sub> = 0.1 V or V <sub>CC</sub> - 0.1 V
		4.5	2.25	1.35	1.35			
		5.5	2.75	1.65	1.65			
V <sub>OH</sub>	Minimum High Level Output Voltage	3.0	2.99	2.9	2.9		V	I <sub>OUT</sub> = -50 μA
		4.5	4.49	4.4	4.4			
		5.5	5.49	5.4	5.4			
	I <sub>OH</sub>	*V <sub>IN</sub> = V <sub>IL</sub> or V <sub>IH</sub> -12 mA	3.0	-	2.56	2.46		V
			4.5	-	3.86	3.76		
			5.5	-	4.86	4.76		
V <sub>OL</sub>	Maximum Low Level Output Voltage	3.0	0.002	0.1	0.1		V	I <sub>OUT</sub> = 50 μA
		4.5	0.001	0.1	0.1			
		5.5	0.001	0.1	0.1			
	I <sub>OL</sub>	*V <sub>IN</sub> = V <sub>IL</sub> or V <sub>IH</sub> 12 mA	3.0	-	0.36	0.44		V
			4.5	-	0.36	0.44		
			5.5	-	0.36	0.44		
I <sub>IN</sub>	Maximum Input Leakage Current	5.5	-	±0.1	±1.0		μA	V <sub>I</sub> = V <sub>CC</sub> , GND
I <sub>OZ</sub>	Maximum 3-State Current	5.5	-	±0.5	±5.0		μA	V <sub>I</sub> (OE) = V <sub>IL</sub> , V <sub>IH</sub> V <sub>I</sub> = V <sub>CC</sub> , GND V <sub>O</sub> = V <sub>CC</sub> , GND
I <sub>OLD</sub>	†Minimum Dynamic Output Current	5.5	-	-	75		mA	V <sub>OLD</sub> = 1.65 V Max
I <sub>OHD</sub>		5.5	-	-	-75		mA	V <sub>OHD</sub> = 3.85 V Min
I <sub>CC</sub>	Maximum Quiescent Supply Current	5.5	-	8.0	80		μA	V <sub>IN</sub> = V <sub>CC</sub> or GND

\*All outputs loaded; thresholds on input associated with output under test.

†Maximum test duration 2.0 ms, one output loaded at a time.

NOTE: I<sub>IN</sub> and I<sub>CC</sub> @ 3.0 V are guaranteed to be less than or equal to the respective limit @ 5.5 V V<sub>CC</sub>.

# MC74AC240, MC74ACT240

**AC CHARACTERISTICS** (For Figures and Waveforms – See AND8277/D at [www.onsemi.com](http://www.onsemi.com))

Symbol	Parameter	V <sub>CC</sub> * (V)	74AC			74AC		Unit	Fig. No.
			T <sub>A</sub> = +25°C C <sub>L</sub> = 50 pF			T <sub>A</sub> = -40°C to +85°C C <sub>L</sub> = 50 pF			
			Min	Typ	Max	Min	Max		
t <sub>PLH</sub>	Propagation Delay Data to Output	3.3 5.0	1.5 1.5	6.0 4.5	8.0 6.5	1.0 1.0	9.0 7.0	ns	3-5
t <sub>PHL</sub>	Propagation Delay Data to Output	3.3 5.0	1.5 1.5	5.5 4.5	8.0 6.0	1.0 1.0	8.5 6.5	ns	3-5
t <sub>PZH</sub>	Output Enable Time	3.3 5.0	1.5 1.5	6.0 5.0	10.5 7.0	1.0 1.0	11.0 8.0	ns	3-7
t <sub>PZL</sub>	Output Enable Time	3.3 5.0	1.5 1.5	7.0 5.5	10.0 8.0	1.0 1.0	11.0 8.5	ns	3-8
t <sub>PHZ</sub>	Output Disable Time	3.3 5.0	1.5 1.5	7.0 6.5	10.0 9.0	1.0 1.0	10.5 9.5	ns	3-7
t <sub>PLZ</sub>	Output Disable Time	3.3 5.0	1.5 1.5	7.5 6.5	10.5 9.0	1.0 1.0	11.5 9.5	ns	3-8

\* Voltage Range 3.3 V is 3.3 V ±0.3 V.  
Voltage Range 5.0 V is 5.0 V ±0.5 V.

## DC CHARACTERISTICS

Symbol	Parameter	V <sub>CC</sub> (V)	74ACT		74ACT		Unit	Conditions
			T <sub>A</sub> = +25°C		T <sub>A</sub> = -40°C to +85°C			
			Typ	Guaranteed Limits				
V <sub>IH</sub>	Minimum High Level Input Voltage	4.5	1.5	2.0	2.0		V	V <sub>OUT</sub> = 0.1 V or V <sub>CC</sub> - 0.1 V
		5.5	1.5	2.0	2.0			
V <sub>IL</sub>	Maximum Low Level Input Voltage	4.5	1.5	0.8	0.8		V	V <sub>OUT</sub> = 0.1 V or V <sub>CC</sub> - 0.1 V
		5.5	1.5	0.8	0.8			
V <sub>OH</sub>	Minimum High Level Output Voltage	4.5	4.49	4.4	4.4		V	I <sub>OUT</sub> = -50 μA
		5.5	5.49	5.4	5.4			
		4.5	-	3.86	3.76		V	*V <sub>IN</sub> = V <sub>IL</sub> or V <sub>IH</sub> I <sub>OH</sub> -24 mA -24 mA
		5.5	-	4.86	4.76			
V <sub>OL</sub>	Maximum Low Level Output Voltage	4.5	0.001	0.1	0.1		V	I <sub>OUT</sub> = 50 μA
		5.5	0.001	0.1	0.1			
		4.5	-	0.36	0.44		V	*V <sub>IN</sub> = V <sub>IL</sub> or V <sub>IH</sub> 24 mA I <sub>OL</sub> 24 mA
		5.5	-	0.36	0.44			
I <sub>IN</sub>	Maximum Input Leakage Current	5.5	-	±0.1	±1.0		μA	V <sub>I</sub> = V <sub>CC</sub> , GND
ΔI <sub>CC</sub> T	Additional Max. I <sub>CC</sub> /Input	5.5	0.6	-	1.5		mA	V <sub>I</sub> = V <sub>CC</sub> - 2.1 V
I <sub>OZ</sub>	Maximum 3-State Current	5.5	-	±0.5	±5.0		μA	V <sub>I</sub> (OE) = V <sub>IL</sub> , V <sub>IH</sub> V <sub>I</sub> = V <sub>CC</sub> , GND V <sub>O</sub> = V <sub>CC</sub> , GND
I <sub>OLD</sub>	†Minimum Dynamic Output Current	5.5	-	-	75		mA	V <sub>OLD</sub> = 1.65 V Max
I <sub>OHD</sub>		5.5	-	-	-75		mA	V <sub>OHD</sub> = 3.85 V Min
I <sub>CC</sub>	Maximum Quiescent Supply Current	5.5	-	8.0	80		μA	V <sub>IN</sub> = V <sub>CC</sub> or GND

\*All outputs loaded; thresholds on input associated with output under test.

†Maximum test duration 2.0 ms, one output loaded at a time.

# MC74AC240, MC74ACT240

**AC CHARACTERISTICS** (For Figures and Waveforms – See Section 3 of the ON Semiconductor FACT Data Book, DL138/D)

Symbol	Parameter	V <sub>CC</sub> * (V)	74ACT			74ACT		Unit	Fig. No.
			T <sub>A</sub> = +25°C C <sub>L</sub> = 50 pF			T <sub>A</sub> = -40°C to +85°C C <sub>L</sub> = 50 pF			
			Min	Typ	Max	Min	Max		
t <sub>PLH</sub>	Propagation Delay Data to Output	5.0	1.5	6.0	8.5	1.5	9.5	ns	3-5
t <sub>PHL</sub>	Propagation Delay Data to Output	5.0	1.5	5.5	7.5	1.5	8.5	ns	3-5
t <sub>pZH</sub>	Output Enable Time	5.0	1.5	7.0	8.5	1.0	9.5	ns	3-7
t <sub>pZL</sub>	Output Enable Time	5.0	2.0	7.0	9.5	1.5	10.5	ns	3-8
t <sub>PHZ</sub>	Output Disable Time	5.0	2.0	8.0	9.5	2.0	10.5	ns	3-7
t <sub>PLZ</sub>	Output Disable Time	5.0	2.5	6.5	10.0	2.0	10.5	ns	3-8

\*Voltage Range 5.0 V is 5.0 V ±0.5 V.

## CAPACITANCE

Symbol	Parameter	Value Typ	Unit	Test Conditions
C <sub>IN</sub>	Input Capacitance	4.5	pF	V <sub>CC</sub> = 5.0 V
C <sub>PD</sub>	Power Dissipation Capacitance	45	pF	V <sub>CC</sub> = 5.0 V

# MC74AC240, MC74ACT240

## ORDERING INFORMATION

Device	Package	Shipping†
MC74AC240DWG	SOIC-20 (Pb-Free)	38 Units / Rail
MC74AC240DWR2G		1000 / Tape & Reel
MC74ACT240DWG		38 Units / Rail
MC74ACT240DWR2G		1000 / Tape & Reel
MC74AC240DTR2G	TSSOP-20 (Pb-Free)	2500 / Tape & Reel
MC74ACT240DTR2G		2500 / Tape & Reel

†For information on tape and reel specifications, including part orientation and tape sizes, please refer to our Tape and Reel Packaging Specifications Brochure, BRD8011/D.

## MARKING DIAGRAMS

SOIC-20W

TSSOP-20

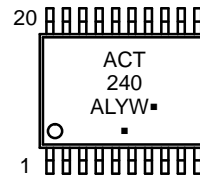
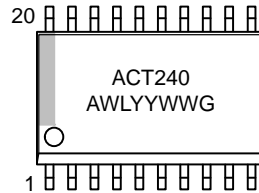
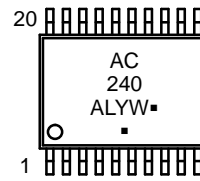
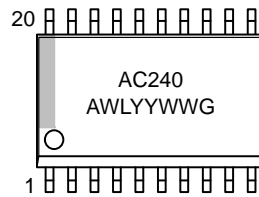

A = Assembly Location  
 WL, L = Wafer Lot  
 YY, Y = Year  
 WW, W = Work Week  
 G or ■ = Pb-Free Package  
 (Note: Microdot may be in either location)

# MECHANICAL CASE OUTLINE

## PACKAGE DIMENSIONS

ON Semiconductor®



SCALE 1:1

SOIC-20 WB  
CASE 751D-05  
ISSUE H

DATE 22 APR 2015



NOTES:

1. DIMENSIONS ARE IN MILLIMETERS.
2. INTERPRET DIMENSIONS AND TOLERANCES PER ASME Y14.5M, 1994.
3. DIMENSIONS D AND E DO NOT INCLUDE MOLD PROTRUSION.
4. MAXIMUM MOLD PROTRUSION 0.15 PER SIDE.
5. DIMENSION B DOES NOT INCLUDE DAMBAR PROTRUSION. ALLOWABLE PROTRUSION SHALL BE 0.13 TOTAL IN EXCESS OF B DIMENSION AT MAXIMUM MATERIAL CONDITION.

DIM	MILLIMETERS	
	MIN	MAX
A	2.35	2.65
A1	0.10	0.25
b	0.35	0.49
c	0.23	0.32
D	12.65	12.95
E	7.40	7.60
e	1.27 BSC	
H	10.05	10.55
h	0.25	0.75
L	0.50	0.90
θ	0°	7°

RECOMMENDED  
SOLDERING FOOTPRINT\*

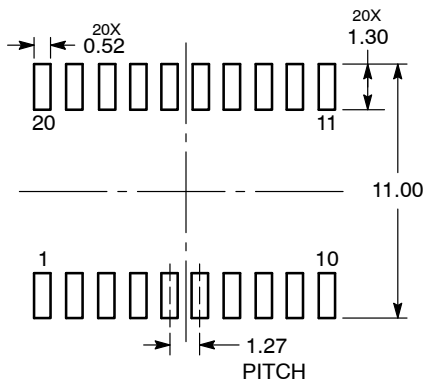

DIMENSIONS: MILLIMETERS

\*For additional information on our Pb-Free strategy and soldering details, please download the ON Semiconductor Soldering and Mounting Techniques Reference Manual, SOLDERRM/D.

GENERIC  
MARKING DIAGRAM\*

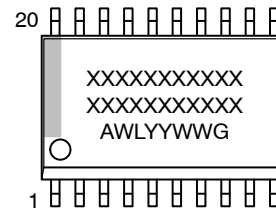

- XXXXXX = Specific Device Code
- A = Assembly Location
- WL = Wafer Lot
- YY = Year
- WW = Work Week
- G = Pb-Free Package

\*This information is generic. Please refer to device data sheet for actual part marking. Pb-Free indicator, "G" or microdot "▪", may or may not be present.

DOCUMENT NUMBER:	98ASB42343B	Electronic versions are uncontrolled except when accessed directly from the Document Repository. Printed versions are uncontrolled except when stamped "CONTROLLED COPY" in red.
DESCRIPTION:	SOIC-20 WB	PAGE 1 OF 1

ON Semiconductor and are trademarks of Semiconductor Components Industries, LLC dba ON Semiconductor or its subsidiaries in the United States and/or other countries. ON Semiconductor reserves the right to make changes without further notice to any products herein. ON Semiconductor makes no warranty, representation or guarantee regarding the suitability of its products for any particular purpose, nor does ON Semiconductor assume any liability arising out of the application or use of any product or circuit, and specifically disclaims any and all liability, including without limitation special, consequential or incidental damages. ON Semiconductor does not convey any license under its patent rights nor the rights of others.

# MECHANICAL CASE OUTLINE

## PACKAGE DIMENSIONS

ON Semiconductor®



TSSOP-20 WB  
CASE 948E  
ISSUE D

DATE 17 FEB 2016

SCALE 2:1



NOTES:

1. DIMENSIONING AND TOLERANCING PER ANSI Y14.5M, 1982.
2. CONTROLLING DIMENSION: MILLIMETER.
3. DIMENSION A DOES NOT INCLUDE MOLD FLASH, PROTRUSIONS OR GATE BURRS. MOLD FLASH OR GATE BURRS SHALL NOT EXCEED 0.15 (0.006) PER SIDE.
4. DIMENSION B DOES NOT INCLUDE INTERLEAD FLASH OR PROTRUSION. INTERLEAD FLASH OR PROTRUSION SHALL NOT EXCEED 0.25 (0.010) PER SIDE.
5. DIMENSION K DOES NOT INCLUDE DAMBAR PROTRUSION. ALLOWABLE DAMBAR PROTRUSION SHALL BE 0.08 (0.003) TOTAL IN EXCESS OF THE K DIMENSION AT MAXIMUM MATERIAL CONDITION.
6. TERMINAL NUMBERS ARE SHOWN FOR REFERENCE ONLY.
7. DIMENSION A AND B ARE TO BE DETERMINED AT DATUM PLANE -W-.

DIM	MILLIMETERS		INCHES	
	MIN	MAX	MIN	MAX
A	6.40	6.60	0.252	0.260
B	4.30	4.50	0.169	0.177
C	---	1.20	---	0.047
D	0.05	0.15	0.002	0.006
F	0.50	0.75	0.020	0.030
G	0.65 BSC		0.026 BSC	
H	0.27	0.37	0.011	0.015
J	0.09	0.20	0.004	0.008
J1	0.09	0.16	0.004	0.006
K	0.19	0.30	0.007	0.012
K1	0.19	0.25	0.007	0.010
L	6.40 BSC		0.252 BSC	
M	0°	8°	0°	8°



SOLDERING FOOTPRINT



GENERIC MARKING DIAGRAM\*



- A = Assembly Location
- L = Wafer Lot
- Y = Year
- W = Work Week
- = Pb-Free Package

(Note: Microdot may be in either location)

\*This information is generic. Please refer to device data sheet for actual part marking. Pb-Free indicator, "G" or microdot "▪", may or may not be present.

DOCUMENT NUMBER:	98ASH70169A	Electronic versions are uncontrolled except when accessed directly from the Document Repository. Printed versions are uncontrolled except when stamped "CONTROLLED COPY" in red.
DESCRIPTION:	TSSOP-20 WB	PAGE 1 OF 1

ON Semiconductor and ON are trademarks of Semiconductor Components Industries, LLC dba ON Semiconductor or its subsidiaries in the United States and/or other countries. ON Semiconductor reserves the right to make changes without further notice to any products herein. ON Semiconductor makes no warranty, representation or guarantee regarding the suitability of its products for any particular purpose, nor does ON Semiconductor assume any liability arising out of the application or use of any product or circuit, and specifically disclaims any and all liability, including without limitation special, consequential or incidental damages. ON Semiconductor does not convey any license under its patent rights nor the rights of others.



**onsemi**, **Onsemi**, and other names, marks, and brands are registered and/or common law trademarks of Semiconductor Components Industries, LLC dba "**onsemi**" or its affiliates and/or subsidiaries in the United States and/or other countries. **onsemi** owns the rights to a number of patents, trademarks, copyrights, trade secrets, and other intellectual property. A listing of **onsemi**'s product/patent coverage may be accessed at [www.onsemi.com/site/pdf/Patent-Marking.pdf](http://www.onsemi.com/site/pdf/Patent-Marking.pdf). **onsemi** reserves the right to make changes at any time to any products or information herein, without notice. The information herein is provided "as-is" and **onsemi** makes no warranty, representation or guarantee regarding the accuracy of the information, product features, availability, functionality, or suitability of its products for any particular purpose, nor does **onsemi** assume any liability arising out of the application or use of any product or circuit, and specifically disclaims any and all liability, including without limitation special, consequential or incidental damages. Buyer is responsible for its products and applications using **onsemi** products, including compliance with all laws, regulations and safety requirements or standards, regardless of any support or applications information provided by **onsemi**. "Typical" parameters which may be provided in **onsemi** data sheets and/or specifications can and do vary in different applications and actual performance may vary over time. All operating parameters, including "Typicals" must be validated for each customer application by customer's technical experts. **onsemi** does not convey any license under any of its intellectual property rights nor the rights of others. **onsemi** products are not designed, intended, or authorized for use as a critical component in life support systems or any FDA Class 3 medical devices or medical devices with a same or similar classification in a foreign jurisdiction or any devices intended for implantation in the human body. Should Buyer purchase or use **onsemi** products for any such unintended or unauthorized application, Buyer shall indemnify and hold **onsemi** and its officers, employees, subsidiaries, affiliates, and distributors harmless against all claims, costs, damages, and expenses, and reasonable attorney fees arising out of, directly or indirectly, any claim of personal injury or death associated with such unintended or unauthorized use, even if such claim alleges that **onsemi** was negligent regarding the design or manufacture of the part. **onsemi** is an Equal Opportunity/Affirmative Action Employer. This literature is subject to all applicable copyright laws and is not for resale in any manner.

## PUBLICATION ORDERING INFORMATION

### LITERATURE FULFILLMENT:

Email Requests to: [orderlit@onsemi.com](mailto:orderlit@onsemi.com)

**onsemi Website:** [www.onsemi.com](http://www.onsemi.com)

### TECHNICAL SUPPORT

**North American Technical Support:**

Voice Mail: 1 800-282-9855 Toll Free USA/Canada

Phone: 011 421 33 790 2910

**Europe, Middle East and Africa Technical Support:**

Phone: 00421 33 790 2910

For additional information, please contact your local Sales Representative