

ON Semiconductor

Is Now

The logo for onsemi, featuring the word "onsemi" in a dark teal, lowercase, sans-serif font. The letter "i" is stylized with a white dot and a teal vertical bar. A small orange triangle is positioned above the top right of the "i". A trademark symbol (TM) is located to the right of the logo.

To learn more about onsemi™, please visit our website at
www.onsemi.com

onsemi and **onsemi** and other names, marks, and brands are registered and/or common law trademarks of Semiconductor Components Industries, LLC dba "**onsemi**" or its affiliates and/or subsidiaries in the United States and/or other countries. **onsemi** owns the rights to a number of patents, trademarks, copyrights, trade secrets, and other intellectual property. A listing of **onsemi** product/patent coverage may be accessed at www.onsemi.com/site/pdf/Patent-Marking.pdf. **onsemi** reserves the right to make changes at any time to any products or information herein, without notice. The information herein is provided "as-is" and **onsemi** makes no warranty, representation or guarantee regarding the accuracy of the information, product features, availability, functionality, or suitability of its products for any particular purpose, nor does **onsemi** assume any liability arising out of the application or use of any product or circuit, and specifically disclaims any and all liability, including without limitation special, consequential or incidental damages. Buyer is responsible for its products and applications using **onsemi** products, including compliance with all laws, regulations and safety requirements or standards, regardless of any support or applications information provided by **onsemi**. "Typical" parameters which may be provided in **onsemi** data sheets and/or specifications can and do vary in different applications and actual performance may vary over time. All operating parameters, including "Typicals" must be validated for each customer application by customer's technical experts. **onsemi** does not convey any license under any of its intellectual property rights nor the rights of others. **onsemi** products are not designed, intended, or authorized for use as a critical component in life support systems or any FDA Class 3 medical devices or medical devices with a same or similar classification in a foreign jurisdiction or any devices intended for implantation in the human body. Should Buyer purchase or use **onsemi** products for any such unintended or unauthorized application, Buyer shall indemnify and hold **onsemi** and its officers, employees, subsidiaries, affiliates, and distributors harmless against all claims, costs, damages, and expenses, and reasonable attorney fees arising out of, directly or indirectly, any claim of personal injury or death associated with such unintended or unauthorized use, even if such claim alleges that **onsemi** was negligent regarding the design or manufacture of the part. **onsemi** is an Equal Opportunity/Affirmative Action Employer. This literature is subject to all applicable copyright laws and is not for resale in any manner. Other names and brands may be claimed as the property of others.

MC74AC646, MC74ACT646

Octal Transceiver/Register with 3-State Outputs (Non-inverting)

The MC74AC646/74ACT646 consist of registered bus transceiver circuits, with outputs, D-type flip-flops and control circuitry providing multiplexed transmission of data directly from the input bus or from the internal storage registers. Data on the A or B bus will be loaded into the respective registers on the LOW-to-HIGH transition of the appropriate clock pin (CAB or CBA). The four fundamental data handling functions available are illustrated Figures 1 to 4.

Features

- Independent Registers for A and B Buses
- Multiplexed Real-Time and Stored Data Transfers
- Choice of True and Inverting Data Paths
- 3-State Outputs
- 300 mil Slim Dual In-Line Package
- Outputs Source/Sink 24 mA
- 'ACT646 Has TTL Compatible Inputs
- These are Pb-Free Devices

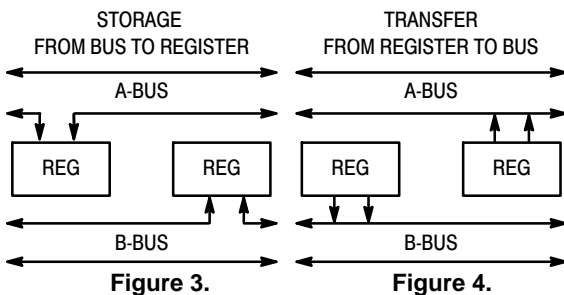
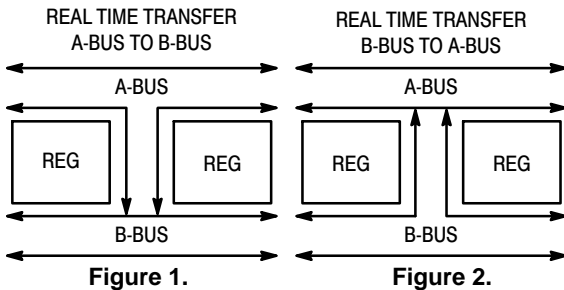

ON Semiconductor™

www.onsemi.com

MARKING DIAGRAMS

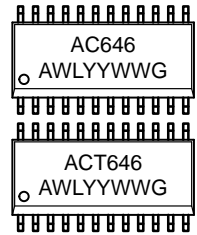

A = Assembly Location
WL = Wafer Lot
YY = Year
WW = Work Week
G = Pb-Free Package

ORDERING INFORMATION

See detailed ordering and shipping information in the package dimensions section on page 9 of this data sheet.

MC74AC646, MC74ACT646

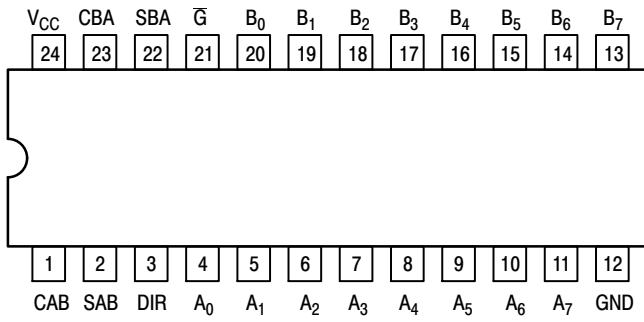

PIN ASSIGNMENT

PIN	FUNCTION
A ₀ –A ₇	Data Register Inputs Data Register A Outputs
B ₀ –B ₇	Data Register B Inputs Data Register B Outputs
CAB, CBA	Clock Pulse Inputs
SAB, SBA	Transmit/Receive Inputs
DIR, \bar{G}	Output Enable Inputs

Figure 5. Pinout: 24-Lead Packages Conductors
(Top View)

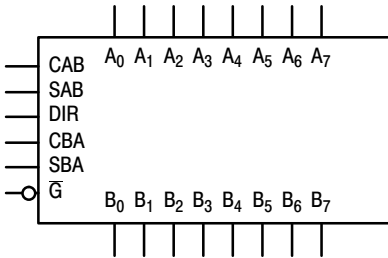
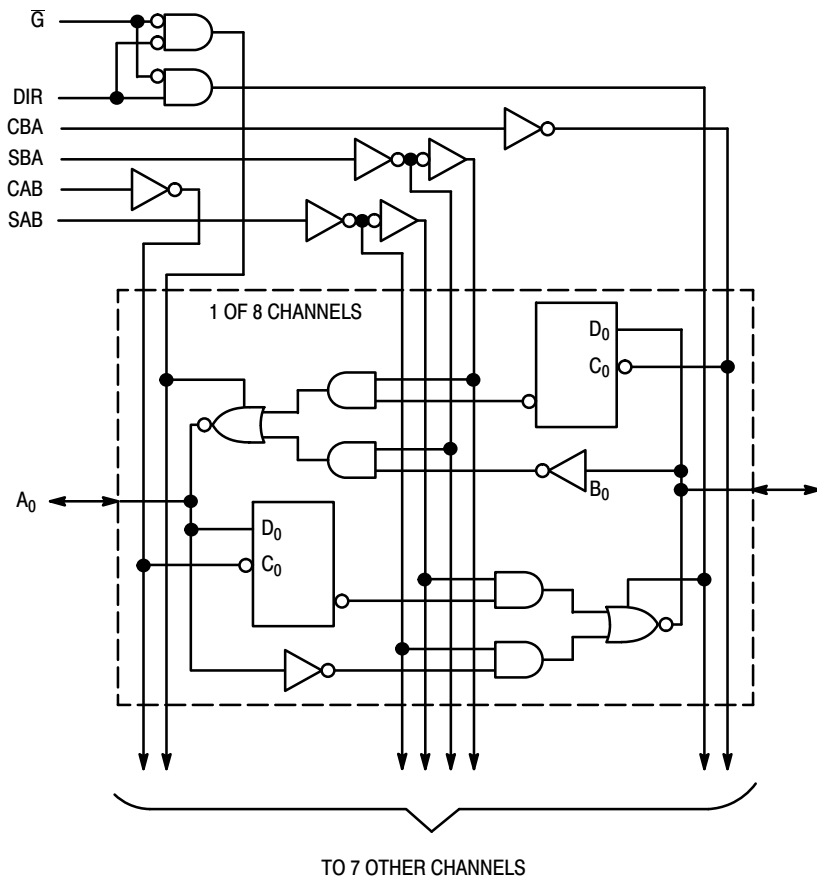

Figure 6. Logic Symbol



NOTE: This diagram is provided only for the understanding of logic operations and should not be used to estimate propagation delays.

Figure 7. Logic Diagram

MC74AC646, MC74ACT646

FUNCTION TABLE

Inputs						Data I/O*		Operation or Function
\overline{G}	DIR	CAB	CBA	SAB	SBA	A ₀ -A ₇	B ₀ -B ₇	
H	X	H or L	H or L	X	X	Input	Input	Isolation Store A and B Data
H	X	┐	┐	X	X			
L	L	X	X	X	L	Output	Input	Real Time B Data to A Bus Stored B Data to A Bus
L	L	X	X	X	H			
L	H	X	X	L	X	Input	Output	Real Time A Data to B Bus Stored A Data to B Bus
L	H	H or L	X	H	X			

*The data output functions may be enabled or disabled by various signals at the \overline{G} and DIR inputs. Data input functions are always enabled; i.e., data at the bus pins will be stored on every LOW-to-HIGH transition of the appropriate clock inputs.

NOTE: H = HIGH Voltage Level; L = LOW Voltage Level; X = Immaterial; ┐ = LOW-to-HIGH Transition

MC74AC646, MC74ACT646

MAXIMUM RATINGS

Symbol	Parameter	Value	Unit	
V _{CC}	DC Supply Voltage (Referenced to GND)	-0.5 to +7.0	V	
V _{IN}	DC Input Voltage (Referenced to GND)	-0.5 to V _{CC} +0.5	V	
V _{OUT}	DC Output Voltage (Referenced to GND) (Note 1)	-0.5 to V _{CC} +0.5	V	
I _{IK}	DC Input Diode Current	±20	mA	
I _{OK}	DC Output Diode Current	±50	mA	
I _{OUT}	DC Output Sink/Source Current	±50	mA	
I _{CC}	DC Supply Current, per Output Pin	±50	mA	
I _{GND}	DC Ground Current, per Output Pin	±100	mA	
T _{STG}	Storage Temperature Range	-65 to +150	°C	
T _L	Lead temperature, 1 mm from Case for 10 Seconds	260	°C	
T _J	Junction Temperature Under Bias	140	°C	
θ _{JA}	Thermal Resistance (Note 2)	59.8	°C/W	
MSL	Moisture Sensitivity	Level 1		
F _R	Flammability Rating	Oxygen Index: 30% – 35% UL 94 V-0 @ 0.125 in		
V _{ESD}	ESD Withstand Voltage	Human Body Model (Note 3) Machine Model (Note 4) Charged Device Model (Note 5)	> 2000 > 200 > 1000	V
I _{Latchup}	Latchup Performance	Above V _{CC} and Below GND at 85°C (Note 6)	±100	mA

Stresses exceeding those listed in the Maximum Ratings table may damage the device. If any of these limits are exceeded, device functionality should not be assumed, damage may occur and reliability may be affected.

1. I_{OUT} absolute maximum rating must be observed.
2. The package thermal impedance is calculated in accordance with JESD 51-7.
3. Tested to EIA/JESD22-A114-A.
4. Tested to EIA/JESD22-A115-A.
5. Tested to JESD22-C101-A.
6. Tested to EIA/JESD78.

RECOMMENDED OPERATING CONDITIONS

Symbol	Parameter	Min	Typ	Max	Unit	
V _{CC}	Supply Voltage	'AC	2.0	5.0	6.0	V
		'ACT	4.5	5.0	5.5	
V _{in} , V _{out}	DC Input Voltage, Output Voltage (Ref. to GND)	0	-	V _{CC}	V	
t _r , t _f	Input Rise and Fall Time (Note 1) 'AC Devices except Schmitt Inputs	V _{CC} @ 3.0 V	-	150	-	ns/V
		V _{CC} @ 4.5 V	-	40	-	
		V _{CC} @ 5.5 V	-	25	-	
t _r , t _f	Input Rise and Fall Time (Note 2) 'ACT Devices except Schmitt Inputs	V _{CC} @ 4.5 V	-	10	-	ns/V
		V _{CC} @ 5.5 V	-	8.0	-	
T _A	Operating Ambient Temperature Range	-40	25	85	°C	
I _{OH}	Output Current – High	-	-	-24	mA	
I _{OL}	Output Current – Low	-	-	24	mA	

Functional operation above the stresses listed in the Recommended Operating Ranges is not implied. Extended exposure to stresses beyond the Recommended Operating Ranges limits may affect device reliability.

1. V_{in} from 30% to 70% V_{CC}; see individual Data Sheets for devices that differ from the typical input rise and fall times.
2. V_{in} from 0.8 V to 2.0 V; see individual Data Sheets for devices that differ from the typical input rise and fall times.

MC74AC646, MC74ACT646

DC CHARACTERISTICS

Symbol	Parameter	V _{CC} (V)	74AC		74AC	Unit	Conditions
			T _A = +25°C		T _A = -40°C to +85°C		
			Typ	Guaranteed Limits			
V _{IH}	Minimum High Level Input Voltage	3.0	1.5	2.1	2.1	V	V _{OUT} = 0.1 V or V _{CC} - 0.1 V
		4.5	2.25	3.15	3.15		
		5.5	2.75	3.85	3.85		
V _{IL}	Maximum Low Level Input Voltage	3.0	1.5	0.9	0.9	V	V _{OUT} = 0.1 V or V _{CC} - 0.1 V
		4.5	2.25	1.35	1.35		
		5.5	2.75	1.65	1.65		
V _{OH}	Minimum High Level Output Voltage	3.0	2.99	2.9	2.9	V	I _{OUT} = -50 μA
		4.5	4.49	4.4	4.4		
		5.5	5.49	5.4	5.4		
		3.0	-	2.56	2.46	V	*V _{IN} = V _{IL} or V _{IH} -12 mA I _{OH} -24 mA -24 mA
		4.5	-	3.86	3.76		
		5.5	-	4.86	4.76		
V _{OL}	Maximum Low Level Output Voltage	3.0	0.002	0.1	0.1	V	I _{OUT} = 50 μA
		4.5	0.001	0.1	0.1		
		5.5	0.001	0.1	0.1		
		3.0	-	0.36	0.44	V	*V _{IN} = V _{IL} or V _{IH} 12 mA I _{OL} 24 mA 24 mA
		4.5	-	0.36	0.44		
		5.5	-	0.36	0.44		
I _{IN}	Maximum Input Leakage Current	5.5	-	±0.1	±1.0	μA	V _I = V _{CC} , GND
I _{OZT}	Maximum 3-State Current	5.5	-	±0.6	±6.0	μA	V _I (OE) = V _{IL} , V _{IH} V _I = V _{CC} , GND V _O = V _{CC} , GND
I _{OLD}	†Minimum Dynamic Output Current	5.5	-	-	75	mA	V _{OLD} = 1.65 V Max
I _{OHD}		5.5	-	-	-75	mA	V _{OHD} = 3.85 V Min
I _{CC}	Maximum Quiescent Supply Current	5.5	-	8.0	80	μA	V _{IN} = V _{CC} or GND

*All outputs loaded; thresholds on input associated with output under test.

†Maximum test duration 2.0 ms, one output loaded at a time.

NOTE: I_{IN} and I_{CC} @ 3.0 V are guaranteed to be less than or equal to the respective limit @ 5.5 V V_{CC}.

MC74AC646, MC74ACT646

AC CHARACTERISTICS (For Figures and Waveforms – See Section 3 of the ON Semiconductor FACT Data Book, DL138/D)

Symbol	Parameter	V _{CC} * (V)	74AC			74AC		Unit	Fig. No.
			T _A = +25°C C _L = 50 pF			T _A = -40°C to +85°C C _L = 50 pF			
			Min	Typ	Max	Min	Max		
t _{PLH}	Propagation Delay Clock to Bus	3.3 5.0	4.0 2.5	10.5 7.5	16.5 12	3.0 2.0	18.5 13	ns	3-6
t _{PHL}	Propagation Delay Clock to Bus	3.3 5.0	3.0 2.0	9.5 6.5	14.5 10.5	2.5 1.5	16 11.5	ns	3-6
t _{PLH}	Propagation Delay Bus to Bus	3.3 5.0	2.5 1.5	7.5 5.0	12 8.0	2.0 1.0	13.5 9.0	ns	3-5
t _{PHL}	Propagation Delay Bus to Bus	3.3 5.0	1.5 1.5	7.5 5.0	12.5 9.0	1.5 1.0	13.5 9.5	ns	3-5
t _{PLH}	Propagation Delay SBA or SAB to A _n or B _n (w/A _n or B _n HIGH or LOW)	3.3 5.0	2.0 1.5	8.5 6.0	13.5 10	1.5 1.5	15.5 11	ns	3-6
t _{PHL}	Propagation Delay SBA or SAB to A _n or B _n (w/A _n or B _n HIGH or LOW)	3.3 5.0	1.5 1.5	8.5 6.0	13.5 10	1.5 1.5	15 11	ns	3-6
t _{PZH}	Enable Time G to A _n or B _n	3.3 5.0	2.5 1.5	7.0 5.0	11.5 8.5	2.0 1.5	12.5 9.0	ns	3-7
t _{PZL}	Enable Time Ḡ to A _n or B _n	3.3 5.0	2.5 1.5	7.5 5.5	12.5 9.0	2.0 1.5	14 10	ns	3-8
t _{PHZ}	Disable Time Ḡ to A _n or B _n	3.3 5.0	3.0 2.0	8.0 6.5	12.5 10	2.5 2.0	13.5 11	ns	3-7
t _{PLZ}	Disable Time G to A _n or B _n	3.3 5.0	2.0 1.5	7.5 6.0	12 9.5	2.0 1.5	13.5 10.5	ns	3-8
t _{PZH}	Enable Time DIR to A _n or B _n	3.3 5.0	2.0 1.5	6.5 5.0	11 7.5	1.5 1.0	12 8.5	ns	3-7
t _{PZL}	Enable Time DIR to A _n or B _n	3.3 5.0	2.5 1.5	7.0 5.0	11.5 8.0	2.0 1.0	13 9.0	ns	3-8
t _{PHZ}	Disable Time DIR to A _n or B _n	3.3 5.0	2.5 1.5	7.5 5.5	11.5 9.5	1.5 1.5	12.5 10	ns	3-7
t _{PLZ}	Disable Time DIR to A _n or B _n	3.3 5.0	1.5 1.5	7.5 5.5	12 9.5	1.5 1.5	13.5 10.5	ns	3-8

*Voltage Range 3.3 V is 3.3 V ±0.3 V.
Voltage Range 5.0 V is 5.0 V ±0.5 V.

MC74AC646, MC74ACT646

AC OPERATING REQUIREMENTS

Symbol	Parameter	V _{CC} * (V)	74AC		74AC		Unit	Fig. No.
			T _A = +25°C C _L = 50 pF		T _A = -40°C to +85°C C _L = 50 pF			
			Typ	Guaranteed Minimum				
t _s	Setup Time, HIGH or LOW Bus to Clock	3.3	2.0	5.0	5.5	ns	3-9	
		5.0	1.5	4.0	4.5			
t _h	Hold Time, HIGH or LOW Bus to Clock	3.3	-1.5	0	0	ns	3-9	
		5.0	-0.5	0.5	1.0			
t _w	Clock Pulse Width HIGH or LOW	3.3	2.0	3.5	4.5	ns	3-6	
		5.0	2.0	3.5	3.5			

*Voltage Range 3.3 V is 3.3 V ±0.3 V.
Voltage Range 5.0 V is 5.0 V ±0.5 V.

DC CHARACTERISTICS

Symbol	Parameter	V _{CC} (V)	74ACT		74ACT		Unit	Conditions
			T _A = +25°C		T _A = -40°C to +85°C			
			Typ	Guaranteed Limits				
V _{IH}	Minimum High Level Input Voltage	4.5	1.5	2.0	2.0	V	V _{OUT} = 0.1 V or V _{CC} - 0.1 V	
		5.5	1.5	2.0	2.0			
V _{IL}	Maximum Low Level Input Voltage	4.5	1.5	0.8	0.8	V	V _{OUT} = 0.1 V or V _{CC} - 0.1 V	
		5.5	1.5	0.8	0.8			
V _{OH}	Minimum High Level Output Voltage	4.5	4.49	4.4	4.4	V	I _{OUT} = -50 μA	
		5.5	5.49	5.4	5.4			
		4.5	-	3.86	3.76	V	*V _{IN} = V _{IL} or V _{IH} -24 mA I _{OH} -24 mA	
		5.5	-	4.86	4.76			
V _{OL}	Maximum Low Level Output Voltage	4.5	0.001	0.1	0.1	V	I _{OUT} = 50 μA	
		5.5	0.001	0.1	0.1			
		4.5	-	0.36	0.44	V	*V _{IN} = V _{IL} or V _{IH} 24 mA I _{OL} 24 mA	
		5.5	-	0.36	0.44			
I _{IN}	Maximum Input Leakage Current	5.5	-	±0.1	±1.0	μA	V _I = V _{CC} , GND	
ΔI _{CCT}	Additional Max. I _{CC} /Input	5.5	0.6	-	1.5	mA	V _I = V _{CC} - 2.1 V	
I _{OZT}	Maximum 3-State Current	5.5	-	±0.6	±6.0	μA	V _I (OE) = V _{IL} , V _{IH} V _I = V _{CC} , GND V _O = V _{CC} , GND	
I _{OLD}	†Minimum Dynamic Output Current	5.5	-	-	75	mA	V _{OLD} = 1.65 V Max	
I _{OHD}		5.5	-	-	-75	mA	V _{OHD} = 3.85 V Min	
I _{CC}	Maximum Quiescent Supply Current	5.5	-	8.0	80	μA	V _{IN} = V _{CC} or GND	

*All outputs loaded; thresholds on input associated with output under test.
†Maximum test duration 2.0 ms, one output loaded at a time.

MC74AC646, MC74ACT646

AC CHARACTERISTICS (For Figures and Waveforms – See Section 3 of the ON Semiconductor FACT Data Book, DL138/D)

Symbol	Parameter	V _{CC} * (V)	74ACT			74ACT		Unit	Fig. No.
			T _A = +25°C C _L = 50 pF			T _A = -40°C to +85°C C _L = 50 pF			
			Min	Typ	Max	Min	Max		
t _{PLH}	Propagation Delay Clock to Bus	5.0	3.5	12.0	14.5	3.0	16.0	ns	3-6
t _{PHL}	Propagation Delay Clock to Bus	5.0	4.0	12.0	14.5	3.5	16.0	ns	3-6
t _{PLH}	Propagation Delay Bus to Bus	5.0	3.0	8.5	11.0	2.5	12.0	ns	3-5
t _{PHL}	Propagation Delay Bus to Bus	5.0	2.5	8.5	11.0	2.0	12.0	ns	3-5
t _{PLH}	Propagation Delay SBA or SAB to A _n or B _n (w/A _n or B _n HIGH or LOW)	5.0	3.0	9.5	12.0	2.5	13.0	ns	3-6
t _{PHL}	Propagation Delay SBA or SAB to A _n or B _n (w/A _n or B _n HIGH or LOW)	5.0	3.0	9.5	12.0	2.5	13.0	ns	3-6
t _{PZH}	Enable Time G̅ to A _n or B _n	5.0	2.0	9.0	11.0	1.5	12.0	ns	3-7
t _{PZL}	Enable Time G̅ to A _n or B _n	5.0	3.5	9.0	11.0	3.0	12.0	ns	3-8
t _{PHZ}	Disable Time G̅ to A _n or B _n	5.0	5.0	10.5	13.0	4.5	14.5	ns	3-7
t _{PLZ}	Disable Time G̅ to A _n or B _n	5.0	3.5	10.0	12.5	3.0	14.0	ns	3-8
t _{PZH}	Enable Time DIR to A _n or B _n	5.0	2.0	6.5	12.5	1.5	13.5	ns	3-7
t _{PZL}	Enable Time DIR to A _n or B _n	5.0	3.5	6.5	12.5	3.0	13.5	ns	3-8
t _{PHZ}	Disable Time DIR to A _n or B _n	5.0	5.0	8.5	12.5	4.5	13.5	ns	3-7
t _{PLZ}	Disable Time DIR to A _n or B _n	5.0	3.5	8.5	12.5	3.0	13.5	ns	3-8

*Voltage Range 5.0 V is 5.0 V ±0.5 V.

MC74AC646, MC74ACT646

AC OPERATING REQUIREMENTS

Symbol	Parameter	V _{CC} * (V)	74ACT		74ACT	Unit	Fig. No.
			T _A = +25°C C _L = 50 pF		T _A = -40°C to +85°C C _L = 50 pF		
			Typ	Guaranteed Minimum			
t _s	Setup Time, HIGH or LOW Bus to Clock	5.0	-	7.0	8.0	ns	3-9
t _h	Hold Time, HIGH or LOW Bus to Clock	5.0	-	2.5	2.5	ns	3-9
t _w	Clock Pulse Width HIGH or LOW	5.0	-	7.0	8.0	ns	3-6

*Voltage Range 5.0 V is 5.0 V ±0.5 V.

CAPACITANCE

Symbol	Parameter	Value Typ	Unit	Test Conditions
C _{IN}	Input Capacitance	4.5	pF	V _{CC} = 5.0 V
C _{I/O}	Input/Output Capacitance	15	pF	V _{CC} = 5.0 V
C _{PD}	Power Dissipation Capacitance	60	pF	V _{CC} = 5.0 V

ORDERING INFORMATION

Device	Package	Shipping†
MC74AC646DWR2G	SOIC-24 (Pb-Free)	1000 / Tape & Reel
MC74ACT646DWG		30 Units / Rail
MC74ACT646DWR2G		1000 / Tape & Reel

†For information on tape and reel specifications, including part orientation and tape sizes, please refer to our Tape and Reel Packaging Specifications Brochure, BRD8011/D.

MC74AC646, MC74ACT646

PACKAGE DIMENSIONS

SOIC-24 WB
DW SUFFIX
CASE 751E-04
ISSUE F

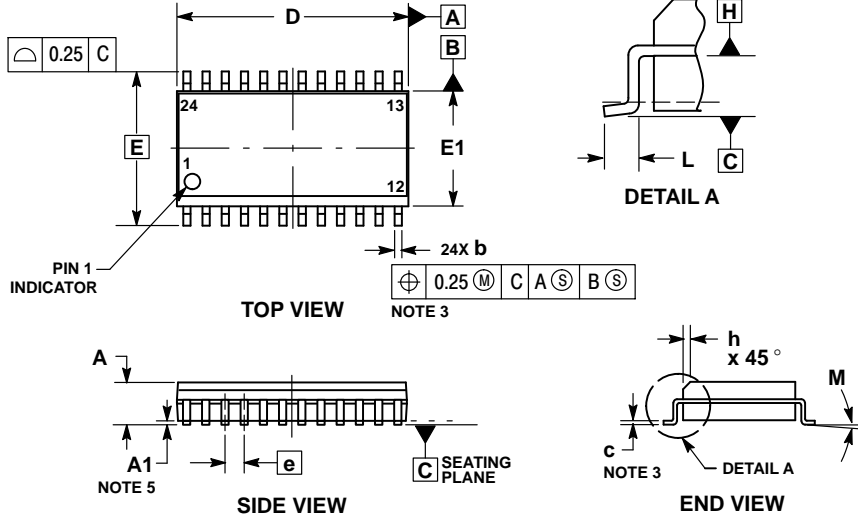

NOTES:

1. DIMENSIONING AND TOLERANCING PER ASME Y14.5M, 1994.
2. CONTROLLING DIMENSION: MILLIMETERS.
3. DIMENSIONS b AND c APPLY TO THE FLAT SECTION OF THE LEAD AND ARE MEASURED BETWEEN 0.10 AND 0.25 FROM THE LEAD TIP.
4. DIMENSIONS D AND E1 DO NOT INCLUDE MOLD FLASH, PROTRUSIONS OR GATE BURRS. MOLD FLASH, PROTRUSIONS OR GATE BURRS SHALL NOT EXCEED 0.15 mm PER SIDE. INTERLEAD FLASH OR PROTRUSION SHALL NOT EXCEED 0.25 PER SIDE. DIMENSIONS D AND E1 ARE DETERMINED AT DATUM H.
5. A1 IS DEFINED AS THE VERTICAL DISTANCE FROM THE SEATING PLANE TO THE LOWEST POINT ON THE PACKAGE BODY.

RECOMMENDED SOLDERING FOOTPRINT*

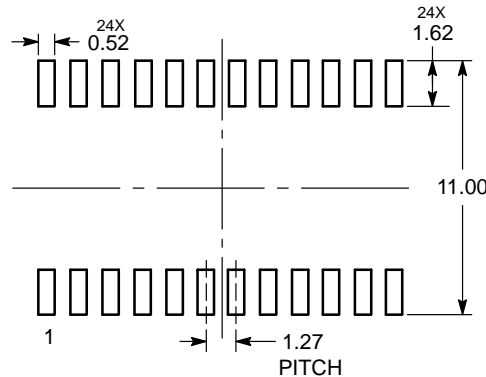

*For additional information on our Pb-Free strategy and soldering details, please download the ON Semiconductor Soldering and Mounting Techniques Reference Manual, SOLDERRM/D.

ON Semiconductor and the are registered trademarks of Semiconductor Components Industries, LLC (SCILLC) or its subsidiaries in the United States and/or other countries. SCILLC owns the rights to a number of patents, trademarks, copyrights, trade secrets, and other intellectual property. A listing of SCILLC's product/patent coverage may be accessed at www.onsemi.com/site/pdf/Patent-Marking.pdf. SCILLC reserves the right to make changes without further notice to any products herein. SCILLC makes no warranty, representation or guarantee regarding the suitability of its products for any particular purpose, nor does SCILLC assume any liability arising out of the application or use of any product or circuit, and specifically disclaims any and all liability, including without limitation special, consequential or incidental damages. "Typical" parameters which may be provided in SCILLC data sheets and/or specifications can and do vary in different applications and actual performance may vary over time. All operating parameters, including "Typicals" must be validated for each customer application by customer's technical experts. SCILLC does not convey any license under its patent rights nor the rights of others. SCILLC products are not designed, intended, or authorized for use as components in systems intended for surgical implant into the body, or other applications intended to support or sustain life, or for any other application in which the failure of the SCILLC product could create a situation where personal injury or death may occur. Should Buyer purchase or use SCILLC products for any such unintended or unauthorized application, Buyer shall indemnify and hold SCILLC and its officers, employees, subsidiaries, affiliates, and distributors harmless against all claims, costs, damages, and expenses, and reasonable attorney fees arising out of, directly or indirectly, any claim of personal injury or death associated with such unintended or unauthorized use, even if such claim alleges that SCILLC was negligent regarding the design or manufacture of the part. SCILLC is an Equal Opportunity/Affirmative Action Employer. This literature is subject to all applicable copyright laws and is not for resale in any manner.

PUBLICATION ORDERING INFORMATION

LITERATURE FULFILLMENT:
Literature Distribution Center for ON Semiconductor
P.O. Box 5163, Denver, Colorado 80217 USA
Phone: 303-675-2175 or 800-344-3860 Toll Free USA/Canada
Fax: 303-675-2176 or 800-344-3867 Toll Free USA/Canada
Email: orderlit@onsemi.com

N. American Technical Support: 800-282-9855 Toll Free
USA/Canada
Europe, Middle East and Africa Technical Support:
Phone: 421 33 790 2910
Japan Customer Focus Center
Phone: 81-3-5817-1050

ON Semiconductor Website: www.onsemi.com
Order Literature: <http://www.onsemi.com/orderlit>

For additional information, please contact your local Sales Representative