

MBR150, MBR160

MBR160 is a Preferred Device

Axial Lead Rectifiers

The MBR150/160 series employs the Schottky Barrier principle in a large area metal-to-silicon power diode. State-of-the-art geometry features epitaxial construction with oxide passivation and metal overlap contact. Ideally suited for use as rectifiers in low-voltage, high-frequency inverters, free wheeling diodes, and polarity protection diodes.

Features

- Low Reverse Current
- Low Stored Charge, Majority Carrier Conduction
- Low Power Loss/High Efficiency
- Highly Stable Oxide Passivated Junction
- These are Pb-Free Devices*

Mechanical Characteristics:

- Case: Epoxy, Molded
- Weight: 0.4 Gram (Approximately)
- Finish: All External Surfaces Corrosion Resistant and Terminal Leads are Readily Solderable
- Lead Temperature for Soldering Purposes: 260°C Max. for 10 Seconds
- Polarity: Cathode Indicated by Polarity Band

MAXIMUM RATINGS

Rating	Symbol	Value	Unit
Peak Repetitive Reverse Voltage MBR150 MBR160	V_{RRM}	50 60	V
Working Peak Reverse Voltage DC Blocking Voltage	V_{RWM} V_R		
RMS Reverse Voltage MBR150 MBR160	$V_{R(RMS)}$	35 42	V
Average Rectified Forward Current (Note 1) ($V_{R(equiv)} \leq 0.2 V_R(dc)$, $T_L = 90^\circ C$, $R_{\theta JA} = 80^\circ C/W$, P.C. Board Mounting, $T_A = 55^\circ C$)	I_O	1.0	A
Nonrepetitive Peak Surge Current (Surge applied at rated load conditions, halfwave, single phase, 60 Hz, $T_L = 70^\circ C$)	I_{FSM}	25 (for one cycle)	A
Operating and Storage Junction Temperature Range (Reverse Voltage Applied)	T_J , T_{stg}	- 65 to +150	°C

THERMAL CHARACTERISTICS (Notes 1 and 2)

Characteristic	Symbol	Max	Unit
Thermal Resistance, Junction-to-Ambient	$R_{\theta JA}$	80	°C/W

Stresses exceeding Maximum Ratings may damage the device. Maximum Ratings are stress ratings only. Functional operation above the Recommended Operating Conditions is not implied. Extended exposure to stresses above the Recommended Operating Conditions may affect device reliability.

1. Lead Temperature reference is cathode lead 1/32" from case.
2. Pulse Test: Pulse Width = 300 μs , Duty Cycle $\leq 2.0\%$.

*For additional information on our Pb-Free strategy and soldering details, please download the ON Semiconductor Soldering and Mounting Techniques Reference Manual, SOLDERRM/D.



ON Semiconductor®

<http://onsemi.com>

SCHOTTKY BARRIER RECTIFIERS 1.0 AMPERE – 50 AND 60 VOLTS

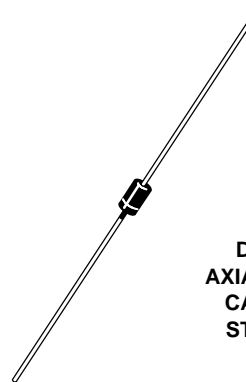

DO-41
AXIAL LEAD
CASE 59
STYLE 1

MARKING DIAGRAM

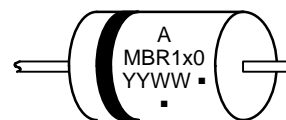

- A = Assembly Location
- MBR1x0 = Device Code
x = 5 or 6
- Y = Year
- WW = Work Week
- = Pb-Free Package

(Note: Microdot may be in either location)

ORDERING INFORMATION

See detailed ordering and shipping information in the package dimensions section on page 4 of this data sheet.

Preferred devices are recommended choices for future use and best overall value.

MBR150, MBR160

ELECTRICAL CHARACTERISTICS ($T_L = 25^\circ\text{C}$ unless otherwise noted) (Note 1)

Characteristic	Symbol	Max	Unit
Maximum Instantaneous Forward Voltage (Note 2) ($i_F = 0.1\text{ A}$) ($i_F = 1.0\text{ A}$) ($i_F = 3.0\text{ A}$)	V_F	0.550 0.750 1.000	V
Maximum Instantaneous Reverse Current @ Rated dc Voltage (Note 2) ($T_L = 25^\circ\text{C}$) ($T_L = 100^\circ\text{C}$)	i_R	0.5 5.0	mA

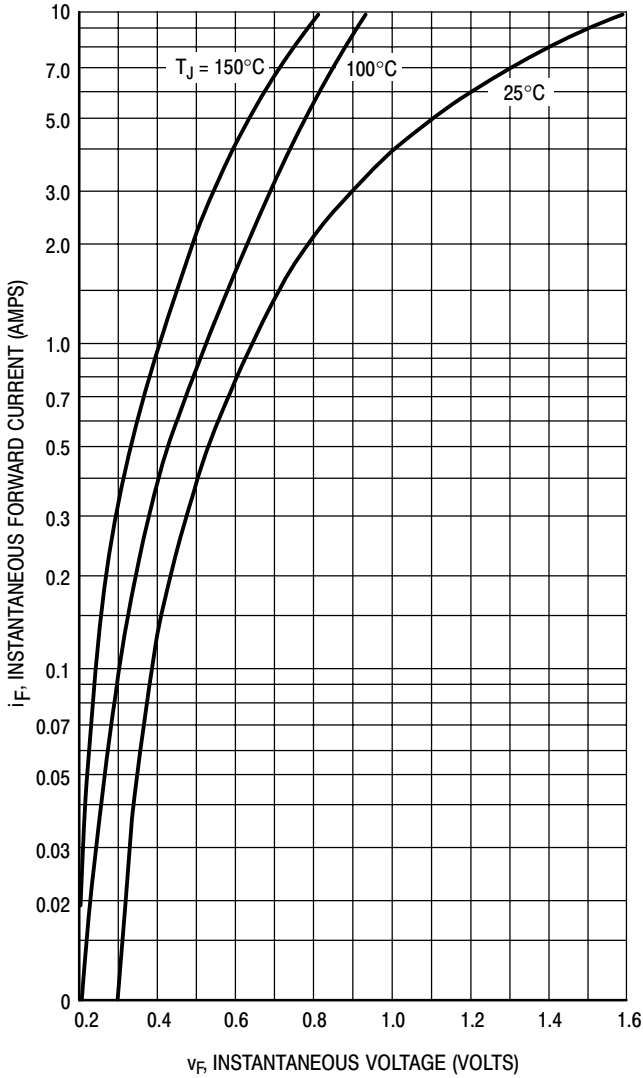

Figure 1. Typical Forward Voltage

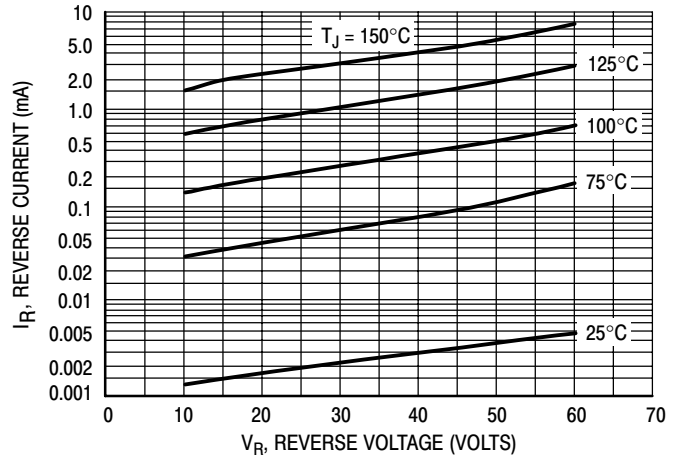

Figure 2. Typical Reverse Current*

*The curves shown are typical for the highest voltage device in the voltage grouping. Typical reverse current for lower voltage selections can be estimated from these same curves if V_R is sufficiently below rated V_R .

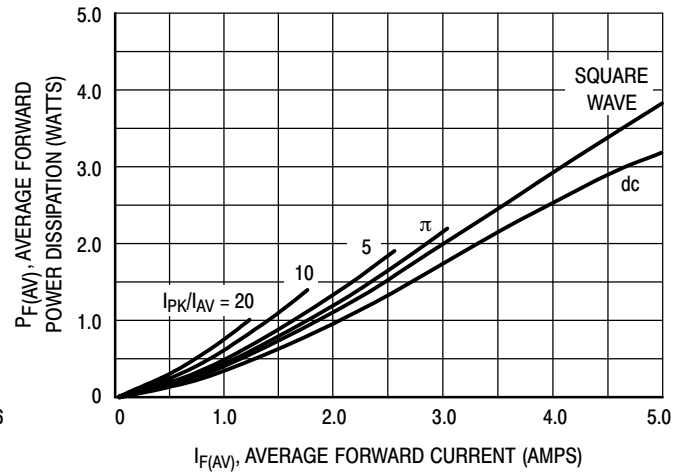

Figure 3. Forward Power Dissipation

MBR150, MBR160

THERMAL CHARACTERISTICS

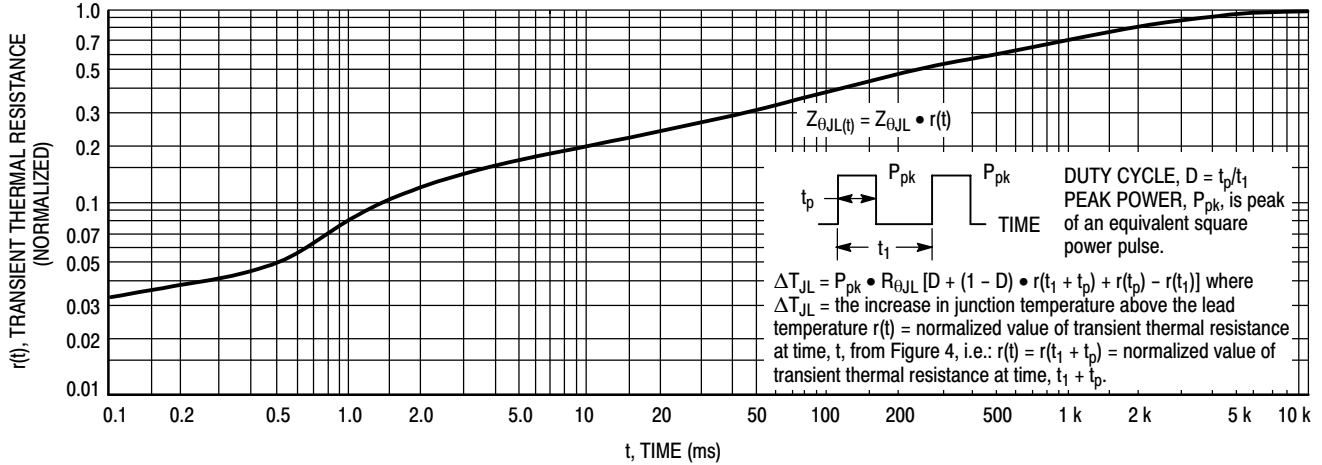

Figure 4. Thermal Response

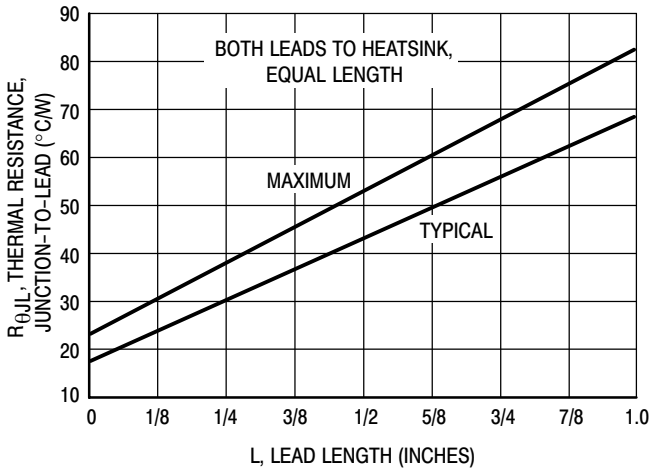

Figure 5. Steady-State Thermal Resistance

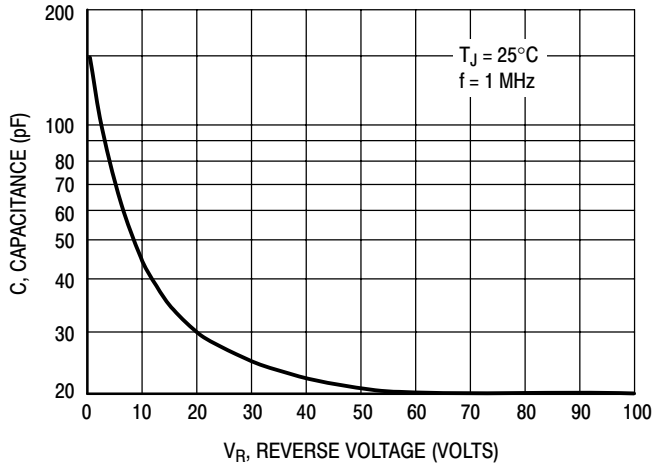

Figure 6. Typical Capacitance

NOTE 1. — MOUNTING DATA:

Data shown for thermal resistance junction-to-ambient ($R_{\theta JA}$) for the mounting shown is to be used as a typical guideline values for preliminary engineering or in case the tie point temperature cannot be measured.

Typical Values for $R_{\theta JA}$ in Still Air

Mounting Method	Lead Length, L (in)				$R_{\theta JA}$
	1/8	1/4	1/2	3/4	
1	52	65	72	85	$^\circ\text{C/W}$
2	67	80	87	100	$^\circ\text{C/W}$
3	—	50			$^\circ\text{C/W}$

NOTE 2. — THERMAL CIRCUIT MODEL:
 (For heat conduction through the leads)

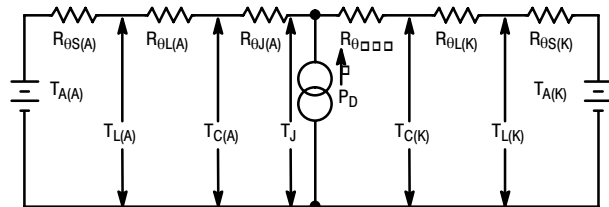

MBR150, MBR160

Use of the above model permits junction to lead thermal resistance for any mounting configuration to be found. For a given total lead length, lowest values occur when one side of the rectifier is brought as close as possible to the heatsink. Terms in the model signify:

T_A = Ambient Temperature T_C = Case Temperature
 T_L = Lead Temperature T_J = Junction Temperature
 $R_{\theta S}$ = Thermal Resistance, Heatsink-to-Ambient
 $R_{\theta L}$ = Thermal Resistance, Lead-to-Heatsink
 $R_{\theta J}$ = Thermal Resistance, Junction-to-Case
 P_D = Power Dissipation

Mounting Method 1

P.C. Board with
 1-1/2" x 1-1/2"
 copper surface.

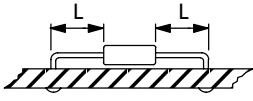

Mounting Method 2

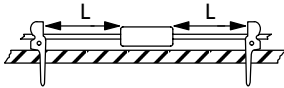

VECTOR PIN MOUNTING

Mounting Method 3

P.C. Board with
 1-1/2" x 1-1/2"
 copper surface.

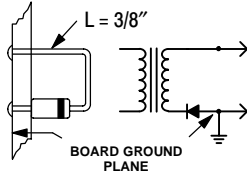

(Subscripts A and K refer to anode and cathode sides, respectively.) Values for thermal resistance components are: $R_{\theta L} = 100^\circ\text{C/W/in}$ typically and 120°C/W/in maximum. $R_{\theta J} = 36^\circ\text{C/W}$ typically and 46°C/W maximum.

NOTE 3. — HIGH FREQUENCY OPERATION:

Since current flow in a Schottky rectifier is the result of majority carrier conduction, it is not subject to junction diode forward and reverse recovery transients due to minority carrier injection and stored charge. Satisfactory circuit analysis work may be performed by using a model consisting of an ideal diode in parallel with a variable capacitance. (See Figure 6)

Rectification efficiency measurements show that operation will be satisfactory up to several megahertz. For example, relative waveform rectification efficiency is approximately 70 percent at 2 MHz, e.g., the ratio of dc power to RMS power in the load is 0.28 at this frequency, whereas perfect rectification would yield 0.406 for sine wave inputs. However, in contrast to ordinary junction diodes, the loss in waveform efficiency is not indicative of power loss: it is simply a result of reverse current flow through the diode capacitance, which lowers the dc output voltage.

ORDERING INFORMATION

Device	Package	Shipping [†]
MBR150	Axial Lead*	1000 Units / Bag
MBR150G	Axial Lead*	1000 Units / Bag
MBR150RL	Axial Lead*	5000 / Tape & Reel
MBR150RLG	Axial Lead*	5000 / Tape & Reel
MBR160	Axial Lead*	1000 Units / Bag
MBR160G	Axial Lead*	1000 Units / Bag
MBR160RL	Axial Lead*	5000 / Tape & Reel
MBR160RLG	Axial Lead*	5000 / Tape & Reel

[†]For information on tape and reel specifications, including part orientation and tape sizes, please refer to our Tape and Reel Packaging Specifications Brochure, BRD8011/D.

*This package is inherently Pb-Free.

MECHANICAL CASE OUTLINE

PACKAGE DIMENSIONS

ON Semiconductor®



AXIAL LEAD CASE 59-10 ISSUE U

DATE 15 FEB 2005

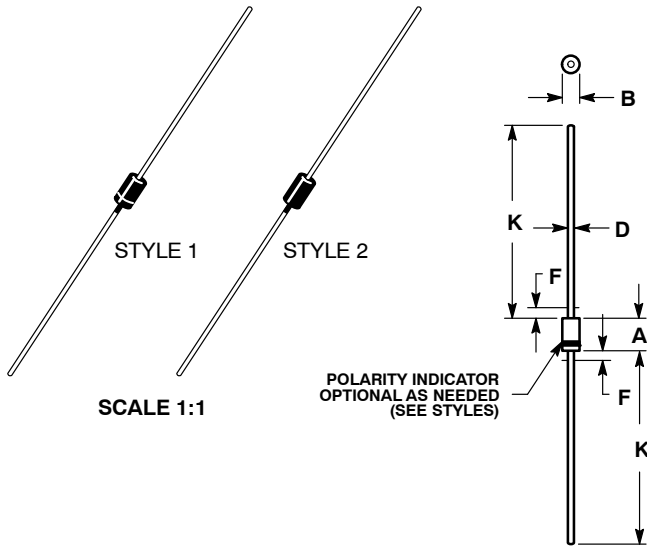

SCALE 1:1

POLARITY INDICATOR
OPTIONAL AS NEEDED
(SEE STYLES)

STYLE 1:
PIN 1. CATHODE (POLARITY BAND)
2. ANODE

STYLE 2:
NO POLARITY

NOTES:

1. DIMENSIONING AND TOLERANCING PER ANSI Y14.5M, 1982.
2. CONTROLLING DIMENSION: INCH.
3. ALL RULES AND NOTES ASSOCIATED WITH JEDEC DO-41 OUTLINE SHALL APPLY
4. POLARITY DENOTED BY CATHODE BAND.
5. LEAD DIAMETER NOT CONTROLLED WITHIN F DIMENSION.

DIM	INCHES		MILLIMETERS	
	MIN	MAX	MIN	MAX
A	0.161	0.205	4.10	5.20
B	0.079	0.106	2.00	2.70
D	0.028	0.034	0.71	0.86
F	---	0.050	---	1.27
K	1.000	---	25.40	---

GENERIC MARKING DIAGRAM*

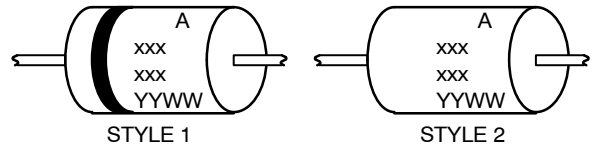

- xxx = Specific Device Code
- A = Assembly Location
- YY = Year
- WW = Work Week

*This information is generic. Please refer to device data sheet for actual part marking. Pb-Free indicator, "G" or microdot "▪", may or may not be present.

DOCUMENT NUMBER:	98ASB42045B	Electronic versions are uncontrolled except when accessed directly from the Document Repository. Printed versions are uncontrolled except when stamped "CONTROLLED COPY" in red.
DESCRIPTION:	AXIAL LEAD	PAGE 1 OF 1

ON Semiconductor and are trademarks of Semiconductor Components Industries, LLC dba ON Semiconductor or its subsidiaries in the United States and/or other countries. ON Semiconductor reserves the right to make changes without further notice to any products herein. ON Semiconductor makes no warranty, representation or guarantee regarding the suitability of its products for any particular purpose, nor does ON Semiconductor assume any liability arising out of the application or use of any product or circuit, and specifically disclaims any and all liability, including without limitation special, consequential or incidental damages. ON Semiconductor does not convey any license under its patent rights nor the rights of others.

onsemi, **Onsemi**, and other names, marks, and brands are registered and/or common law trademarks of Semiconductor Components Industries, LLC dba "**onsemi**" or its affiliates and/or subsidiaries in the United States and/or other countries. **onsemi** owns the rights to a number of patents, trademarks, copyrights, trade secrets, and other intellectual property. A listing of **onsemi**'s product/patent coverage may be accessed at www.onsemi.com/site/pdf/Patent-Marking.pdf. **onsemi** reserves the right to make changes at any time to any products or information herein, without notice. The information herein is provided "as-is" and **onsemi** makes no warranty, representation or guarantee regarding the accuracy of the information, product features, availability, functionality, or suitability of its products for any particular purpose, nor does **onsemi** assume any liability arising out of the application or use of any product or circuit, and specifically disclaims any and all liability, including without limitation special, consequential or incidental damages. Buyer is responsible for its products and applications using **onsemi** products, including compliance with all laws, regulations and safety requirements or standards, regardless of any support or applications information provided by **onsemi**. "Typical" parameters which may be provided in **onsemi** data sheets and/or specifications can and do vary in different applications and actual performance may vary over time. All operating parameters, including "Typicals" must be validated for each customer application by customer's technical experts. **onsemi** does not convey any license under any of its intellectual property rights nor the rights of others. **onsemi** products are not designed, intended, or authorized for use as a critical component in life support systems or any FDA Class 3 medical devices or medical devices with a same or similar classification in a foreign jurisdiction or any devices intended for implantation in the human body. Should Buyer purchase or use **onsemi** products for any such unintended or unauthorized application, Buyer shall indemnify and hold **onsemi** and its officers, employees, subsidiaries, affiliates, and distributors harmless against all claims, costs, damages, and expenses, and reasonable attorney fees arising out of, directly or indirectly, any claim of personal injury or death associated with such unintended or unauthorized use, even if such claim alleges that **onsemi** was negligent regarding the design or manufacture of the part. **onsemi** is an Equal Opportunity/Affirmative Action Employer. This literature is subject to all applicable copyright laws and is not for resale in any manner.

PUBLICATION ORDERING INFORMATION

LITERATURE FULFILLMENT:

Email Requests to: orderlit@onsemi.com

onsemi Website: www.onsemi.com

TECHNICAL SUPPORT

North American Technical Support:

Voice Mail: 1 800-282-9855 Toll Free USA/Canada

Phone: 011 421 33 790 2910

Europe, Middle East and Africa Technical Support:

Phone: 00421 33 790 2910

For additional information, please contact your local Sales Representative