

EFC4K110NUZ

MOSFET – Power, Dual, N-Channel, for 1-2 Cells Lithium-ion Battery Protection 24 V, 2.95 mΩ, 25 A



ON Semiconductor®

www.onsemi.com

Introduction

This Power MOSFET features a low on-state resistance. This device is suitable for applications such as power switches of portable machines. Best suited for 1-2 cells lithium-ion battery applications.

Features

- 2.5 V Drive
- 2 kV ESD HBM
- Common-Drain Type
- ESD Diode-Protected Gate
- This Device is Pb-Free, Halogen Free/BFR Free and is RoHS Compliant

Applications

- 1-2 Cells Lithium-ion Battery Charging and Discharging Switch

Specifications

ABSOLUTE MAXIMUM RATINGS (T_A = 25°C) (Note 1)

Parameter	Symbol	Value	Unit
Source to Source Voltage	V _{SSS}	24	V
Gate to Source Voltage	V _{GSS}	±12	V
Source Current (DC)	I _S	25	A
Source Current (Pulse) PW ≤ 10 μs, duty cycle ≤ 1%	I _{SP}	100	A
Total Dissipation (Note 1)	P _T	2.5	W
Junction Temperature	T _j	150	°C
Storage Temperature	T _{stg}	-55 to +150	°C

Stresses exceeding those listed in the Maximum Ratings table may damage the device. If any of these limits are exceeded, device functionality should not be assumed, damage may occur and reliability may be affected.

THERMAL RESISTANCE RATINGS

Parameter	Symbol	Value	Unit
Junction to Ambient (Note 1)	R _{θJA}	50	°C/W

1. Surface mounted on ceramic substrate (5000 mm² × 0.8 mm).

V _{SSS}	R _{SS(ON)} MAX	I _S MAX
24 V	2.95 mΩ @ 4.5 V	25 A
	3.0 mΩ @ 3.8 V	
	4.7 mΩ @ 3.1 V	
	7.4 mΩ @ 2.5 V	

ELECTRICAL CONNECTION

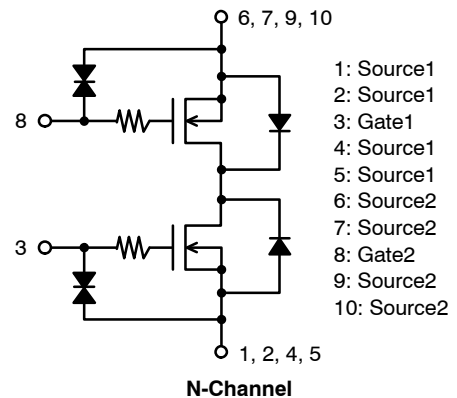

N-Channel

PIN ASSIGNMENT



WLCSP10
(3.20 x 2.10 x 0.14)
CASE 567XT

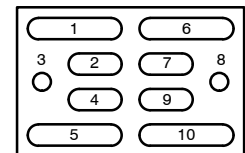

(Bottom View)

MARKING DIAGRAM

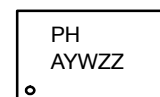

- PH = Specific Device Code
- A = Assembly Location
- Y = Year
- W = Work Week
- ZZ = Assembly Lot

ORDERING INFORMATION

See detailed ordering and shipping information on page 5 of this data sheet.

EFC4K110NUZ

ELECTRICAL CHARACTERISTICS ($T_A = 25^\circ\text{C}$)

Parameter	Symbol	Conditions	Min	Typ	Max	Unit
Source to Source Breakdown Voltage	$V_{(BR)SSS}$	$I_S = 1 \text{ mA}, V_{GS} = 0 \text{ V}$	24			V
Zero-Gate Voltage Source Current	I_{SSS}	$V_{SS} = 19.2 \text{ V}, V_{GS} = 0 \text{ V}$			1	μA
Gate to Source Leakage Current	I_{GSS}	$V_{GS} = \pm 8 \text{ V}, V_{SS} = 0 \text{ V}$			± 10	μA
Gate Threshold Voltage	$V_{GS(th)}$	$V_{SS} = 10 \text{ V}, I_S = 1 \text{ mA}$	0.4		1.3	V
Static Source to Source On-State Resistance	$R_{SS(on)}$	$I_S = 5 \text{ A}, V_{GS} = 4.5 \text{ V}$	1.6	2.4	2.95	$\text{m}\Omega$
		$I_S = 5 \text{ A}, V_{GS} = 3.8 \text{ V}$	1.7	2.5	3.0	$\text{m}\Omega$
		$I_S = 5 \text{ A}, V_{GS} = 3.1 \text{ V}$	2.0	2.9	4.7	$\text{m}\Omega$
		$I_S = 5 \text{ A}, V_{GS} = 2.5 \text{ V}$	2.2	3.6	7.4	$\text{m}\Omega$
Gate Resistance	R_g	$f = 1 \text{ MHz}$		310		Ω
Total Gate Charge	Q_g	$V_{SS} = 11.5 \text{ V}, V_{GS} = 4.5 \text{ V}, I_S = 5 \text{ A}$		49		nC
Turn-ON Delay Time	$t_{d(on)}$	$V_{SS} = 11.5 \text{ V}, V_{GS} = 4.5 \text{ V}, R_L = 2.3 \Omega$ $R_G = 0 \Omega$ Switching Test Circuit		0.6		μs
Rise Time	t_r			1.6		μs
Turn-OFF Delay Time	$t_{d(off)}$			7.3		μs
Fall Time	t_f			3.2		μs
Forward Source to Source Voltage	$V_{F(S-S)}$		$I_S = 3 \text{ A}, V_{GS} = 0 \text{ V}$		0.75	1.2

Product parametric performance is indicated in the Electrical Characteristics for the listed test conditions, unless otherwise noted. Product performance may not be indicated by the Electrical Characteristics if operated under different conditions.

SWITCHING TEST CIRCUIT

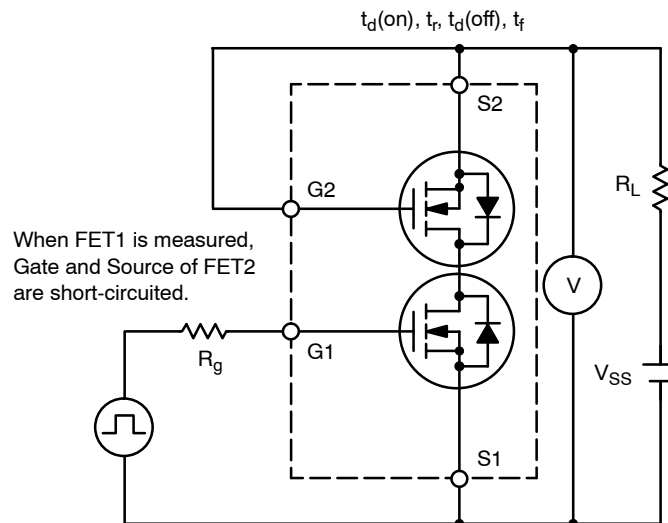

Figure 1. Switching Test Circuit

DEPENDENCY FIGURES

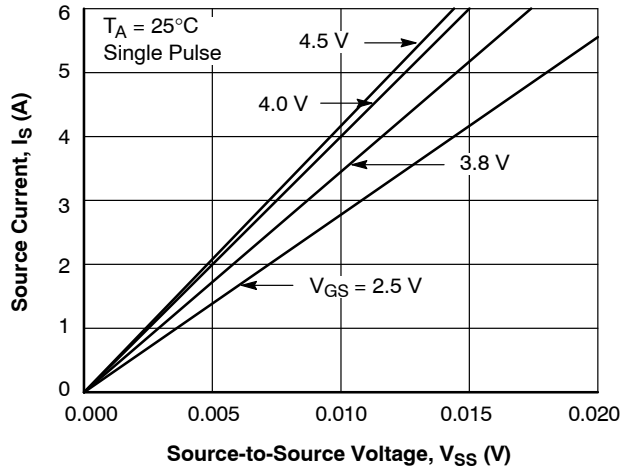

Figure 2. On-Region Characteristics

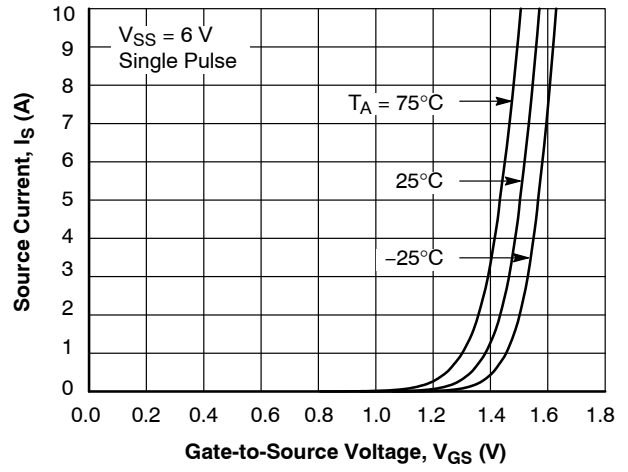

Figure 3. Transfer Characteristics

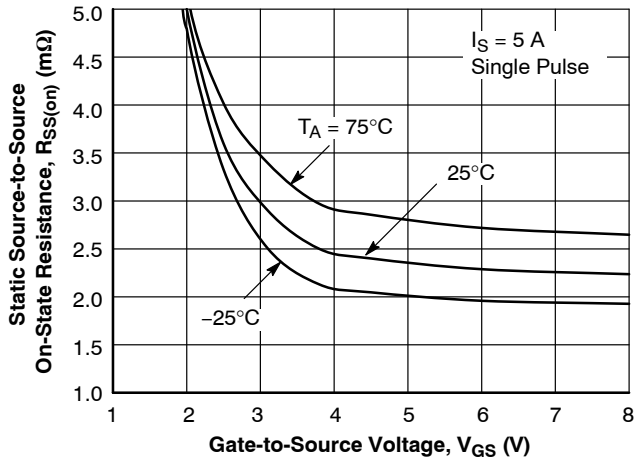

Figure 4. On-Resistance vs. Gate-to-Source Voltage

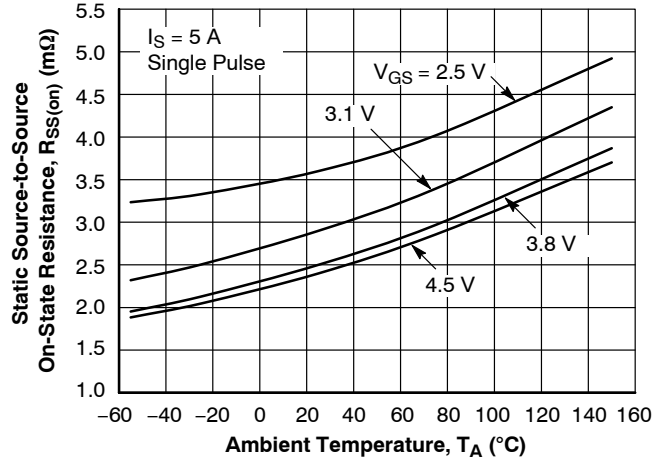

Figure 5. On-Resistance vs. Temperature

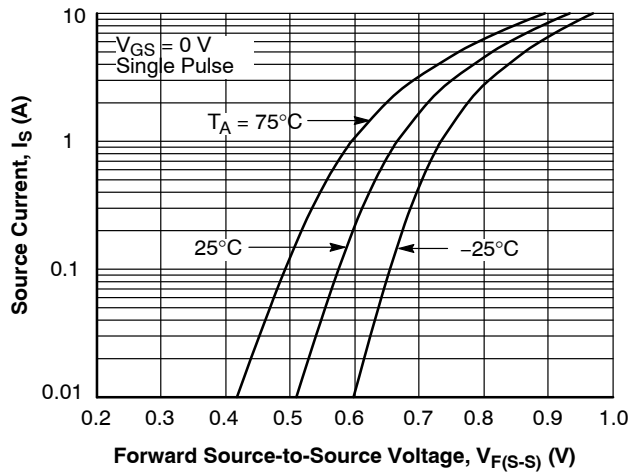

Figure 6. Forward Source-to-Source Voltage vs. Current

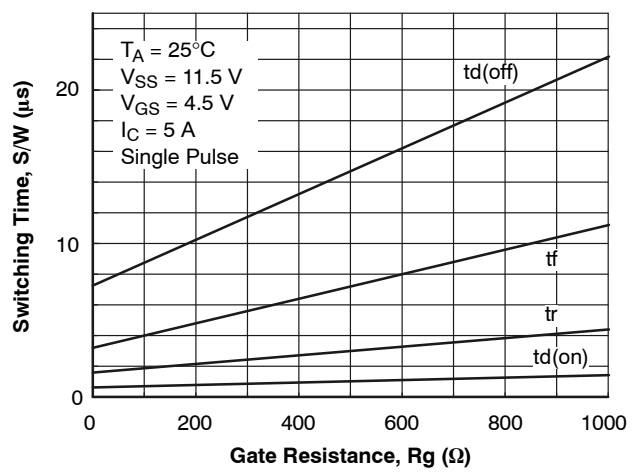

Figure 7. Switching Time vs. Gate Resistance (1)

EFC4K110NUZ

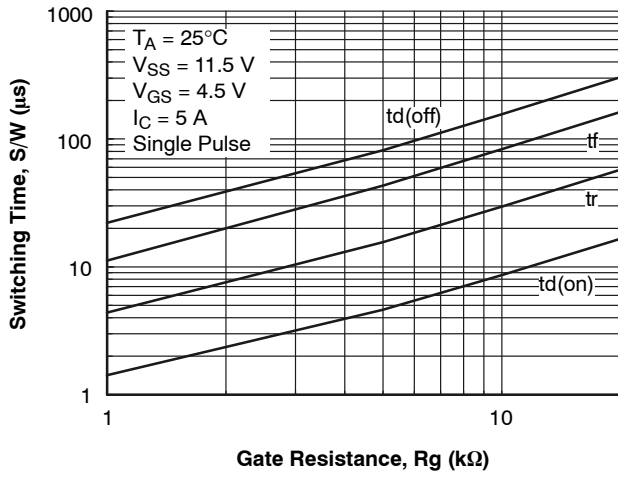

Figure 8. Switching Time vs. Gate Resistance (2)

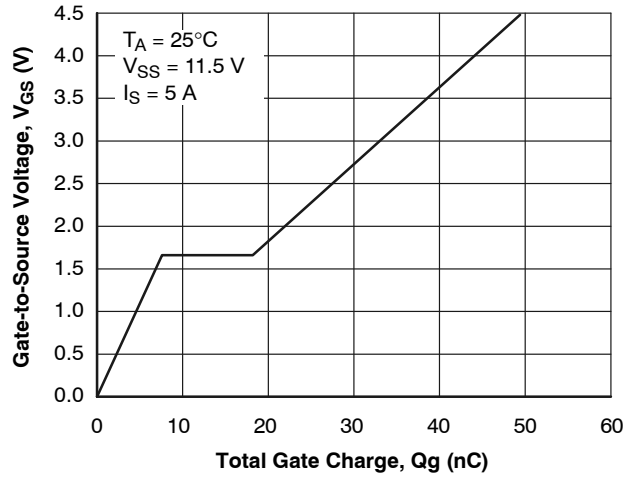

Figure 9. Gate-to-Source Voltage vs. Total Charge

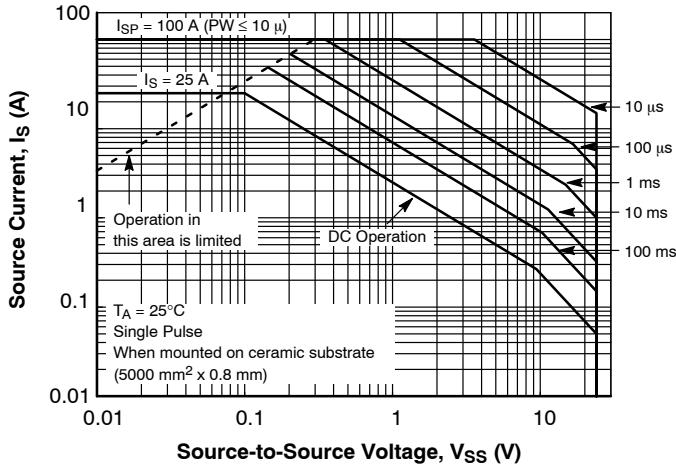

Figure 10. Safe Operating Area

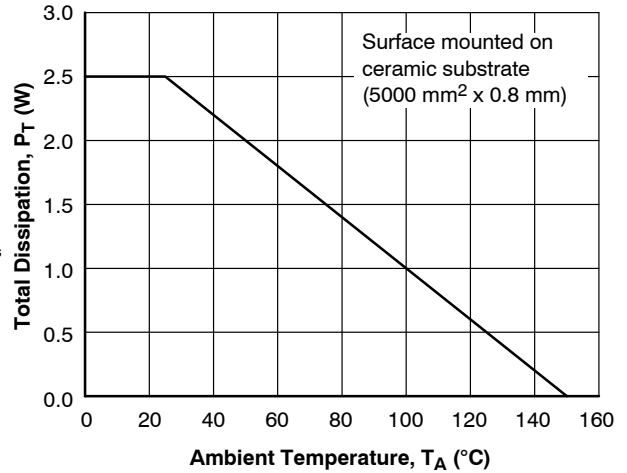

Figure 11. Total Dissipation vs. Temperature

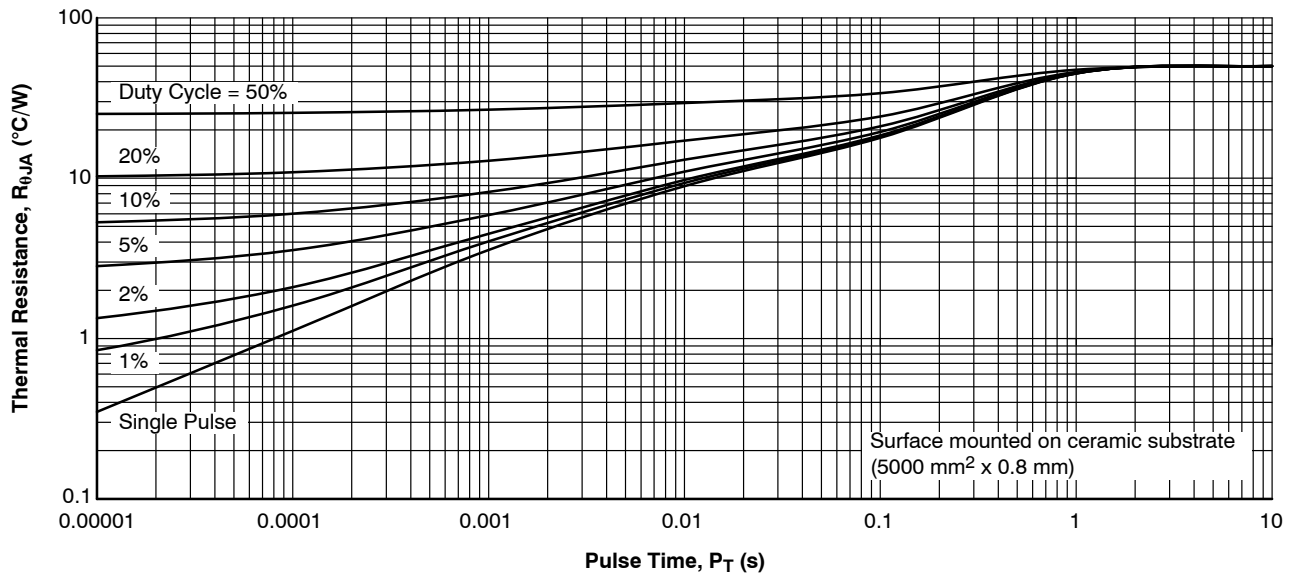

Figure 12. Thermal Response

EFC4K110NUZ

ORDERING INFORMATION

Device	Marking	Package	Shipping [†] (Qty / Packing)
EFC4K110NUZTDG	PH	WLCSP10, 3.20 x 2.10 x 0.14 (Pb-Free / Halogen Free)	5000 / Tape & Reel

[†]For information on tape and reel specifications, including part orientation and tape sizes, please refer to our Tape and Reel Packaging Specifications Brochure, BRD8011/D.

Note on usage: Since the EFC4K110NUZ is a MOSFET product, please avoid using this device in the vicinity of highly charged objects.



WLCSP10 3.2x2.1x0.14
CASE 567XT
ISSUE O

DATE 02 APR 2019

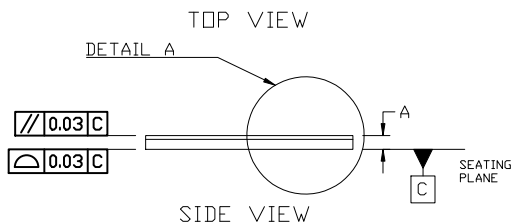
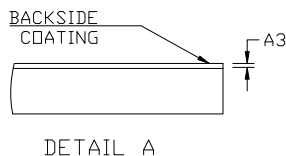
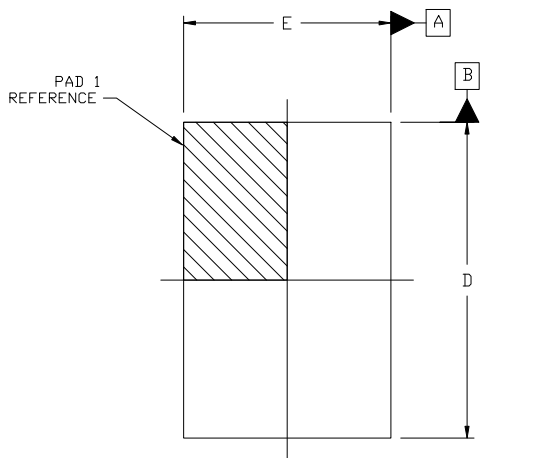

NOTES:

1. DIMENSIONING AND TOLERANCING PER ASME Y14.5M, 2009.
2. CONTROLLING DIMENSION: MILLIMETERS
3. POSITIONAL TOLERANCE APPLIES TO ALL PADS.

DIM	MILLIMETERS		
	MIN.	NOM.	MAX.
A	0.11	0.14	0.17
A3	0.04 REF		
b	0.22	0.25	0.28
b1	0.27	0.30	0.33
b2	0.72	0.75	0.78
b3	1.295	1.325	1.355
D	3.17	3.20	3.23
e	0.50 BSC		
e1	1.0 BSC		
e2	1.575 BSC		
e3	2.50 BSC		

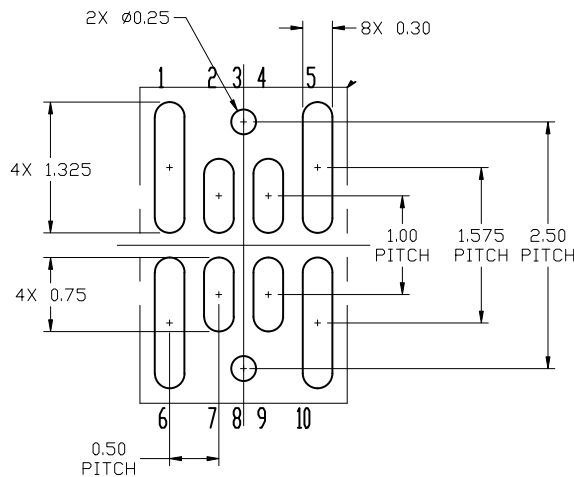
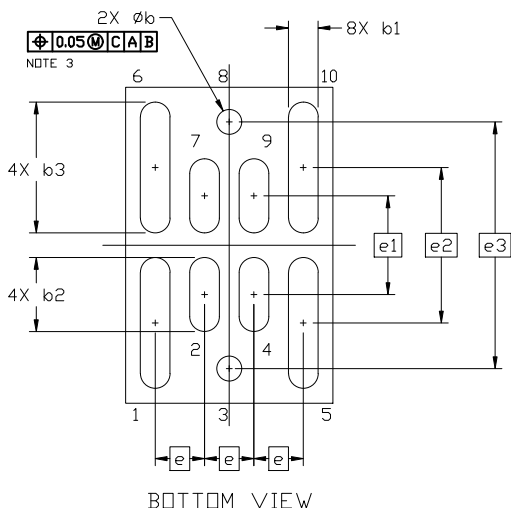

GENERIC MARKING DIAGRAM*

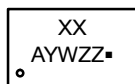

- XX = Specific Device Code
- A = Assembly Location
- Y = Year
- W = Work Week
- ZZ = Assembly Lot Code
- = Pb-Free Package

RECOMMENDED MOUNTING FOOTPRINT*

* For additional information on our Pb-Free strategy and soldering details, please download the ON Semiconductor Soldering and Mounting Techniques Reference Manual, SOLDERRM/D.

*This information is generic. Please refer to device data sheet for actual part marking. Pb-Free indicator, "G" or microdot "▪", may or may not be present. Some products may not follow the Generic Marking.

DOCUMENT NUMBER:	98AON05933H	Electronic versions are uncontrolled except when accessed directly from the Document Repository. Printed versions are uncontrolled except when stamped "CONTROLLED COPY" in red.
DESCRIPTION:	WLCSP10 3.2x2.1x0.14	PAGE 1 OF 1

ON Semiconductor and are trademarks of Semiconductor Components Industries, LLC dba ON Semiconductor or its subsidiaries in the United States and/or other countries. ON Semiconductor reserves the right to make changes without further notice to any products herein. ON Semiconductor makes no warranty, representation or guarantee regarding the suitability of its products for any particular purpose, nor does ON Semiconductor assume any liability arising out of the application or use of any product or circuit, and specifically disclaims any and all liability, including without limitation special, consequential or incidental damages. ON Semiconductor does not convey any license under its patent rights nor the rights of others.

ON Semiconductor and  are trademarks of Semiconductor Components Industries, LLC dba ON Semiconductor or its subsidiaries in the United States and/or other countries. ON Semiconductor owns the rights to a number of patents, trademarks, copyrights, trade secrets, and other intellectual property. A listing of ON Semiconductor's product/patent coverage may be accessed at www.onsemi.com/site/pdf/Patent-Marking.pdf. ON Semiconductor reserves the right to make changes without further notice to any products herein. ON Semiconductor makes no warranty, representation or guarantee regarding the suitability of its products for any particular purpose, nor does ON Semiconductor assume any liability arising out of the application or use of any product or circuit, and specifically disclaims any and all liability, including without limitation special, consequential or incidental damages. Buyer is responsible for its products and applications using ON Semiconductor products, including compliance with all laws, regulations and safety requirements or standards, regardless of any support or applications information provided by ON Semiconductor. "Typical" parameters which may be provided in ON Semiconductor data sheets and/or specifications can and do vary in different applications and actual performance may vary over time. All operating parameters, including "Typicals" must be validated for each customer application by customer's technical experts. ON Semiconductor does not convey any license under its patent rights nor the rights of others. ON Semiconductor products are not designed, intended, or authorized for use as a critical component in life support systems or any FDA Class 3 medical devices or medical devices with a same or similar classification in a foreign jurisdiction or any devices intended for implantation in the human body. Should Buyer purchase or use ON Semiconductor products for any such unintended or unauthorized application, Buyer shall indemnify and hold ON Semiconductor and its officers, employees, subsidiaries, affiliates, and distributors harmless against all claims, costs, damages, and expenses, and reasonable attorney fees arising out of, directly or indirectly, any claim of personal injury or death associated with such unintended or unauthorized use, even if such claim alleges that ON Semiconductor was negligent regarding the design or manufacture of the part. ON Semiconductor is an Equal Opportunity/Affirmative Action Employer. This literature is subject to all applicable copyright laws and is not for resale in any manner.

PUBLICATION ORDERING INFORMATION

LITERATURE FULFILLMENT:

Email Requests to: orderlit@onsemi.com

ON Semiconductor Website: www.onsemi.com

TECHNICAL SUPPORT

North American Technical Support:
Voice Mail: 1 800-282-9855 Toll Free USA/Canada
Phone: 011 421 33 790 2910

Europe, Middle East and Africa Technical Support:

Phone: 00421 33 790 2910

For additional information, please contact your local Sales Representative

Mouser Electronics

Authorized Distributor

Click to View Pricing, Inventory, Delivery & Lifecycle Information:

[ON Semiconductor:](#)

[EFC4K110NUZTDG](#)