

# ON Semiconductor

## Is Now

The logo for onsemi, featuring the word "onsemi" in a dark teal, lowercase, sans-serif font. The letter "i" is stylized with a white dot and a teal vertical bar. A small orange triangle is positioned above the top right of the "i". A trademark symbol (TM) is located to the right of the logo.

To learn more about onsemi™, please visit our website at  
[www.onsemi.com](http://www.onsemi.com)

---

**onsemi** and **onsemi** and other names, marks, and brands are registered and/or common law trademarks of Semiconductor Components Industries, LLC dba "**onsemi**" or its affiliates and/or subsidiaries in the United States and/or other countries. **onsemi** owns the rights to a number of patents, trademarks, copyrights, trade secrets, and other intellectual property. A listing of **onsemi** product/patent coverage may be accessed at [www.onsemi.com/site/pdf/Patent-Marking.pdf](http://www.onsemi.com/site/pdf/Patent-Marking.pdf). **onsemi** reserves the right to make changes at any time to any products or information herein, without notice. The information herein is provided "as-is" and **onsemi** makes no warranty, representation or guarantee regarding the accuracy of the information, product features, availability, functionality, or suitability of its products for any particular purpose, nor does **onsemi** assume any liability arising out of the application or use of any product or circuit, and specifically disclaims any and all liability, including without limitation special, consequential or incidental damages. Buyer is responsible for its products and applications using **onsemi** products, including compliance with all laws, regulations and safety requirements or standards, regardless of any support or applications information provided by **onsemi**. "Typical" parameters which may be provided in **onsemi** data sheets and/or specifications can and do vary in different applications and actual performance may vary over time. All operating parameters, including "Typicals" must be validated for each customer application by customer's technical experts. **onsemi** does not convey any license under any of its intellectual property rights nor the rights of others. **onsemi** products are not designed, intended, or authorized for use as a critical component in life support systems or any FDA Class 3 medical devices or medical devices with a same or similar classification in a foreign jurisdiction or any devices intended for implantation in the human body. Should Buyer purchase or use **onsemi** products for any such unintended or unauthorized application, Buyer shall indemnify and hold **onsemi** and its officers, employees, subsidiaries, affiliates, and distributors harmless against all claims, costs, damages, and expenses, and reasonable attorney fees arising out of, directly or indirectly, any claim of personal injury or death associated with such unintended or unauthorized use, even if such claim alleges that **onsemi** was negligent regarding the design or manufacture of the part. **onsemi** is an Equal Opportunity/Affirmative Action Employer. This literature is subject to all applicable copyright laws and is not for resale in any manner. Other names and brands may be claimed as the property of others.

# EMC2DXV5T1G, EMC3DXV5T1G, EMC4DXV5T1G, EMC5DXV5T1G



ON Semiconductor®

<http://onsemi.com>

## Dual Common Base-Collector Bias Resistor Transistors

### NPN and PNP Silicon Surface Mount Transistors with Monolithic Bias Resistor Network

The BRT (Bias Resistor Transistor) contains a single transistor with a monolithic bias network consisting of two resistors; a series base resistor and a base-emitter resistor. These digital transistors are designed to replace a single device and its external resistor bias network. The BRT eliminates these individual components by integrating them into a single device. In the EMC2DXV5T1G series, two complementary BRT devices are housed in the SOT-553 package which is ideal for low power surface mount applications where board space is at a premium.

#### Features

- Simplifies Circuit Design
- Reduces Board Space
- Reduces Component Count
- NSV Prefix for Automotive and Other Applications Requiring Unique Site and Control Change Requirements; AEC-Q101 Qualified and PPAP Capable
- These are Pb-Free Devices

**MAXIMUM RATINGS** ( $T_A = 25^\circ\text{C}$  unless otherwise noted, common for  $Q_1$  and  $Q_2$ , - minus sign for  $Q_1$  (PNP) omitted)

Rating	Symbol	Value	Unit
Collector-Base Voltage	$V_{CBO}$	50	Vdc
Collector-Emitter Voltage	$V_{CEO}$	50	Vdc
Collector Current	$I_C$	100	mAdc

Stresses exceeding those listed in the Maximum Ratings table may damage the device. If any of these limits are exceeded, device functionality should not be assumed, damage may occur and reliability may be affected.

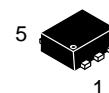
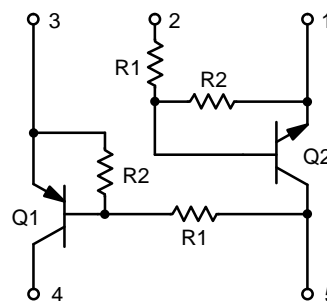

SOT-553  
CASE 463B

#### MARKING DIAGRAM

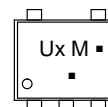

Ux = Specific Device Code  
x = C, 3, E, or 5

M = Date Code

▪ = Pb-Free Package

(Note: Microdot may be in either location)

#### ORDERING INFORMATION

See detailed ordering and shipping information in the package dimensions section on page 2 of this data sheet.

# EMC2DXV5T1G, EMC3DXV5T1G, EMC4DXV5T1G, EMC5DXV5T1G

## THERMAL CHARACTERISTICS

Characteristic	Symbol	Max	Unit
<b>ONE JUNCTION HEATED</b>			
Total Device Dissipation $T_A = 25^\circ\text{C}$ Derate above $25^\circ\text{C}$	$P_D$	357 (Note 1) 2.9 (Note 1)	mW mW/ $^\circ\text{C}$
Thermal Resistance, Junction-to-Ambient	$R_{\theta JA}$	350 (Note 1)	$^\circ\text{C}/\text{W}$
<b>BOTH JUNCTIONS HEATED</b>			
Total Device Dissipation $T_A = 25^\circ\text{C}$ Derate above $25^\circ\text{C}$	$P_D$	500 (Note 1) 4.0 (Note 1)	mW mW/ $^\circ\text{C}$
Thermal Resistance, Junction-to-Ambient	$R_{\theta JA}$	250 (Note 1)	$^\circ\text{C}/\text{W}$
Junction and Storage Temperature	$T_J, T_{stg}$	-55 to +150	$^\circ\text{C}$

1. FR-4 @ Minimum Pad

## DEVICE ORDERING INFORMATION, MARKING AND RESISTOR VALUES

Device	Marking	Transistor 1 – PNP		Transistor 2 – NPN		Package	Shipping†
		R1 (K)	R2 (K)	R1 (K)	R2 (K)		
EMC2DXV5T1G	UC	22	22	22	22	SOT-553 (Pb-Free)	4000 / Tape & Reel
NSVEMC2DXV5T1G*	UC	22	22	22	22		4000 / Tape & Reel
EMC3DXV5T1G	U3	10	10	10	10		4000 / Tape & Reel
EMC3DXV5T5G							8000 / Tape & Reel
EMC4DXV5T1G	UE	10	47	47	47		4000 / Tape & Reel
EMC5DXV5T1G	U5	4.7	10	47	47		4000 / Tape & Reel

†For information on tape and reel specifications, including part orientation and tape sizes, please refer to our Tape and Reel Packaging Specifications Brochure, BRD8011/D.

\*NSV Prefix for Automotive and Other Applications Requiring Unique Site and Control Change Requirements; AEC-Q101 Qualified and PPAP Capable.

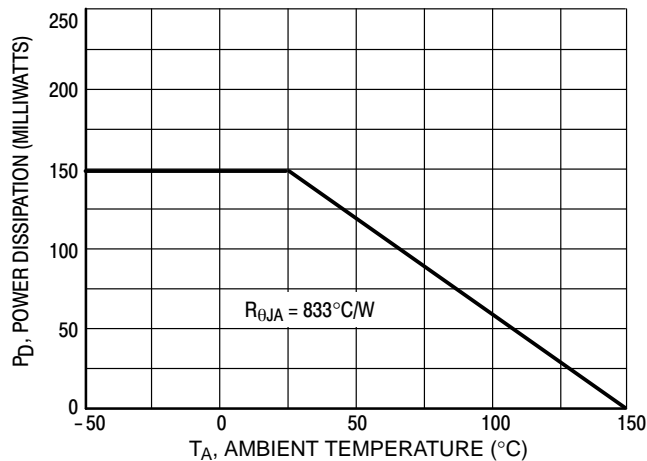

Figure 1. Derating Curve

# EMC2DXV5T1G, EMC3DXV5T1G, EMC4DXV5T1G, EMC5DXV5T1G

## ELECTRICAL CHARACTERISTICS ( $T_A = 25^\circ\text{C}$ unless otherwise noted)

Characteristic	Symbol	Min	Typ	Max	Unit
<b>Q1 TRANSISTOR: PNP OFF CHARACTERISTICS</b>					
Collector-Base Cutoff Current ( $V_{CB} = 50\text{ V}$ , $I_E = 0$ )	$I_{CBO}$	–	–	100	nAdc
Collector-Emitter Cutoff Current ( $V_{CB} = 50\text{ V}$ , $I_B = 0$ )	$I_{CEO}$	–	–	500	nAdc
Emitter-Base Cutoff Current ( $V_{EB} = 6.0\text{ V}$ , $I_C = 0$ )	$I_{EBO}$	–	–	0.2	mAdc
	EMC2DXV5T1G	–	–	0.5	
	EMC3DXV5T1G	–	–	0.2	
	EMC4DXV5T1G	–	–	1.0	
	EMC5DXV5T1G	–	–	–	

## ON CHARACTERISTICS

Collector-Base Breakdown Voltage ( $I_C = 10\ \mu\text{A}$ , $I_E = 0$ )	$V_{(BR)CBO}$	50	–	–	Vdc
Collector-Emitter Breakdown Voltage ( $I_C = 2.0\text{ mA}$ , $I_B = 0$ )	$V_{(BR)CEO}$	50	–	–	Vdc
DC Current Gain ( $V_{CE} = 10\text{ V}$ , $I_C = 5.0\text{ mA}$ )	$h_{FE}$	60	100	–	
	EMC2DXV5T1G	35	60	–	
	EMC3DXV5T1G	80	140	–	
	EMC4DXV5T1G	20	35	–	
	EMC5DXV5T1G	–	–	–	
Collector-Emitter Saturation Voltage ( $I_C = 10\text{ mA}$ , $I_B = 0.3\text{ mA}$ )	$V_{CE(SAT)}$	–	–	0.25	Vdc
Output Voltage (on) ( $V_{CC} = 5.0\text{ V}$ , $V_B = 2.5\text{ V}$ , $R_L = 1.0\text{ k}\Omega$ )	$V_{OL}$	–	–	0.2	Vdc
Output Voltage (off) ( $V_{CC} = 5.0\text{ V}$ , $V_B = 0.5\text{ V}$ , $R_L = 1.0\text{ k}\Omega$ )	$V_{OH}$	4.9	–	–	Vdc
Input Resistor	$R_1$	15.4	22	28.6	$\text{k}\Omega$
	EMC2DXV5T1G	7.0	10	13	
	EMC3DXV5T1G, EMC4DXV5T1G	3.3	4.7	6.1	
	EMC5DXV5T1G	–	–	–	
Resistor Ratio	$R_1/R_2$	0.8	1.0	1.2	
	EMC2DXV5T1G	0.8	1.0	1.2	
	EMC3DXV5T1G	0.17	0.21	0.25	
	EMC4DXV5T1G	0.38	0.47	0.56	
	EMC5DXV5T1G	–	–	–	

## Q2 TRANSISTOR: NPN OFF CHARACTERISTICS

Collector-Base Cutoff Current ( $V_{CB} = 50\text{ V}$ , $I_E = 0$ )	$I_{CBO}$	–	–	100	nAdc
Collector-Emitter Cutoff Current ( $V_{CB} = 50\text{ V}$ , $I_B = 0$ )	$I_{CEO}$	–	–	500	nAdc
Emitter-Base Cutoff Current ( $V_{EB} = 6.0\text{ V}$ , $I_C = 0$ )	$I_{EBO}$	–	–	0.2	mAdc
	EMC2DXV5T1G	–	–	0.5	
	EMC3DXV5T1G	–	–	0.1	
	EMC4DXV5T1G, EMC5DXV5T1G	–	–	–	

## ON CHARACTERISTICS

Collector-Base Breakdown Voltage ( $I_C = 10\ \mu\text{A}$ , $I_E = 0$ )	$V_{(BR)CBO}$	50	–	–	Vdc
Collector-Emitter Breakdown Voltage ( $I_C = 2.0\text{ mA}$ , $I_B = 0$ )	$V_{(BR)CEO}$	50	–	–	Vdc
DC Current Gain ( $V_{CE} = 10\text{ V}$ , $I_C = 5.0\text{ mA}$ )	$h_{FE}$	60	100	–	
	EMC2DXV5T1G	35	60	–	
	EMC3DXV5T1G	80	140	–	
	EMC4DXV5T1G, EMC5DXV5T1G	–	–	–	
Collector-Emitter Saturation Voltage ( $I_C = 10\text{ mA}$ , $I_B = 0.3\text{ mA}$ )	$V_{CE(SAT)}$	–	–	0.25	Vdc
Output Voltage (on) ( $V_{CC} = 5.0\text{ V}$ , $V_B = 2.5\text{ V}$ , $R_L = 1.0\text{ k}\Omega$ )	$V_{OL}$	–	–	0.2	Vdc
Output Voltage (off) ( $V_{CC} = 5.0\text{ V}$ , $V_B = 0.5\text{ V}$ , $R_L = 1.0\text{ k}\Omega$ )	$V_{OH}$	4.9	–	–	Vdc
Input Resistor	$R_1$	15.4	22	28.6	$\text{k}\Omega$
	EMC2DXV5T1G	7.0	10	13	
	EMC3DXV5T1G	33	47	61	
	EMC4DXV5T1G, EMC5DXV5T1G	–	–	–	
Resistor Ratio	$R_1/R_2$	0.8	1.0	1.2	
	EMC2DXV5T1G	0.8	1.0	1.2	
	EMC3DXV5T1G	0.8	1.0	1.2	
	EMC4DXV5T1G, EMC5DXV5T1G	0.8	1.0	1.2	

Product parametric performance is indicated in the Electrical Characteristics for the listed test conditions, unless otherwise noted. Product performance may not be indicated by the Electrical Characteristics if operated under different conditions.

# EMC2DXV5T1G, EMC3DXV5T1G, EMC4DXV5T1G, EMC5DXV5T1G

## TYPICAL ELECTRICAL CHARACTERISTICS – EMC2DXV5T1 PNP TRANSISTOR

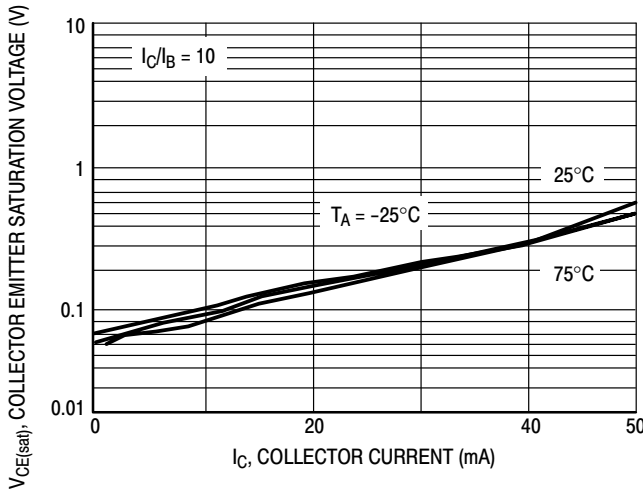

Figure 2.  $V_{CE(sat)}$  versus  $I_C$

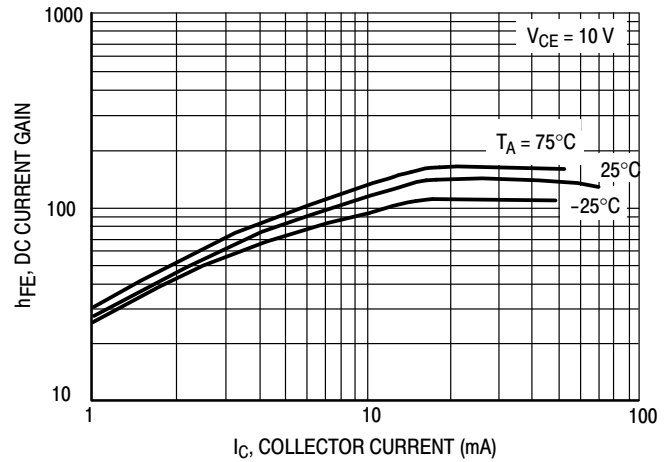

Figure 3. DC Current Gain

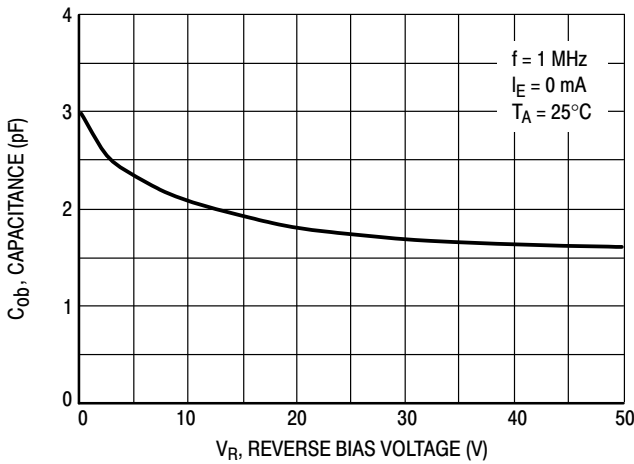

Figure 4. Output Capacitance

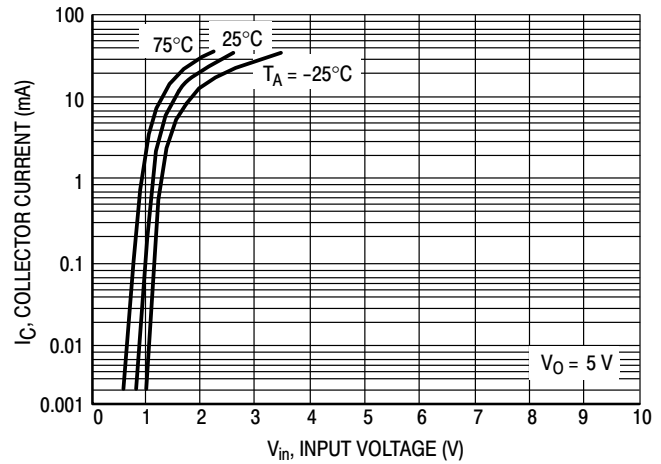

Figure 5. Output Current versus Input Voltage

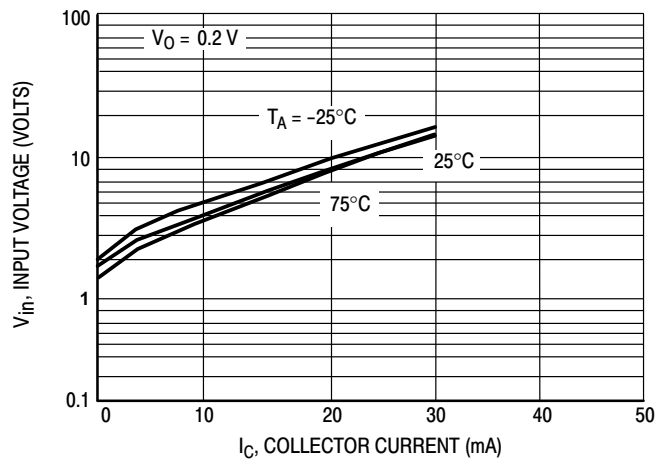

Figure 6. Input Voltage versus Output Current

# EMC2DXV5T1G, EMC3DXV5T1G, EMC4DXV5T1G, EMC5DXV5T1G

## TYPICAL ELECTRICAL CHARACTERISTICS – EMC2DXV5T1 NPN TRANSISTOR

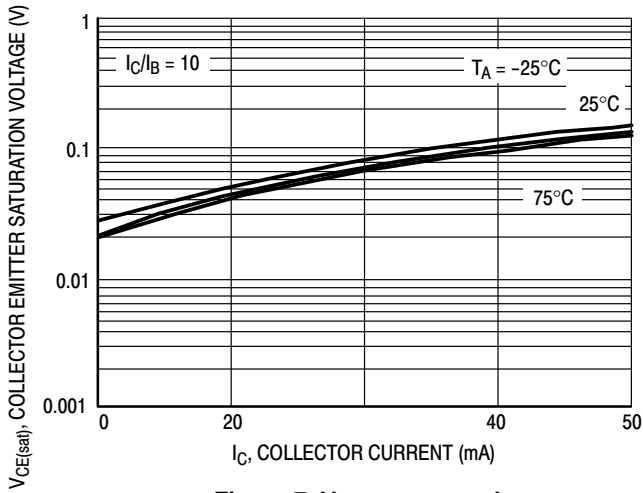

Figure 7.  $V_{CE(sat)}$  versus  $I_C$

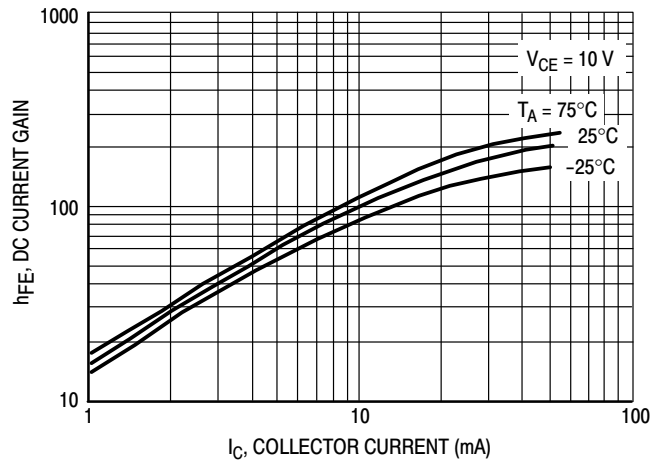

Figure 8. DC Current Gain

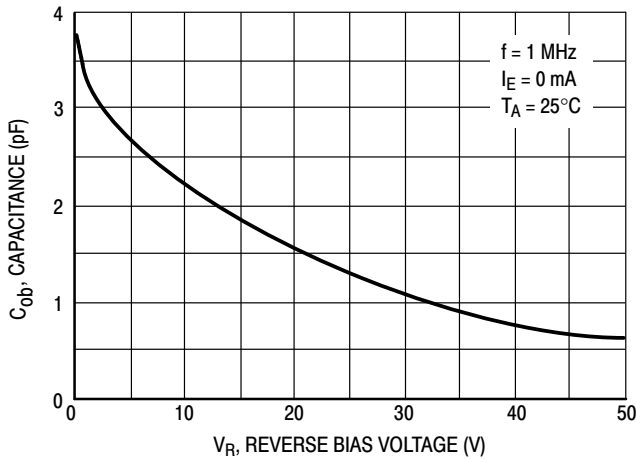

Figure 9. Output Capacitance

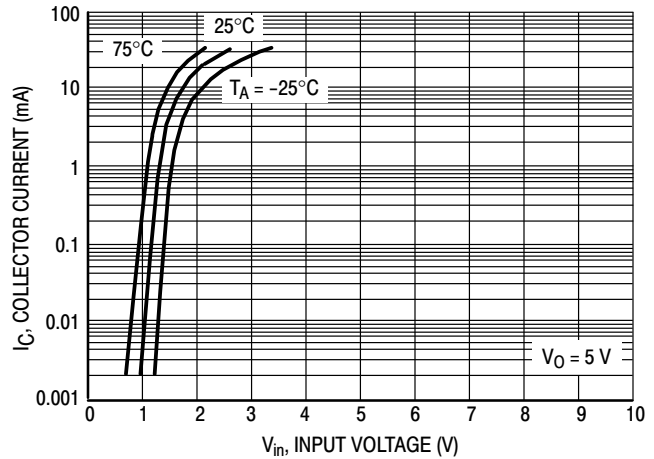

Figure 10. Output Current versus Input Voltage

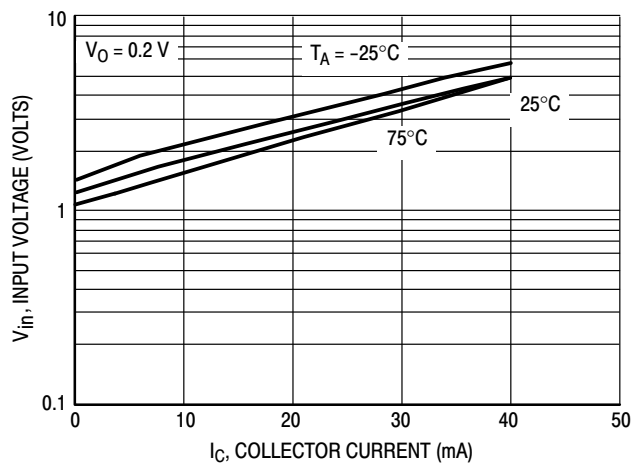

Figure 11. Input Voltage versus Output Current

# EMC2DXV5T1G, EMC3DXV5T1G, EMC4DXV5T1G, EMC5DXV5T1G

## TYPICAL ELECTRICAL CHARACTERISTICS – EMC3DXV5T1 PNP TRANSISTOR

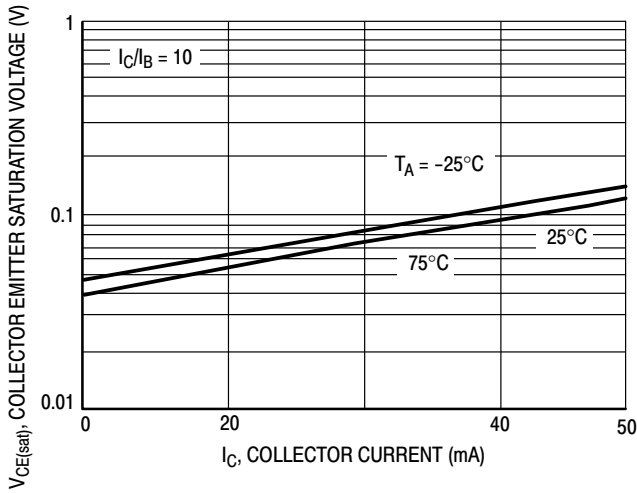

Figure 12.  $V_{CE(sat)}$  versus  $I_C$

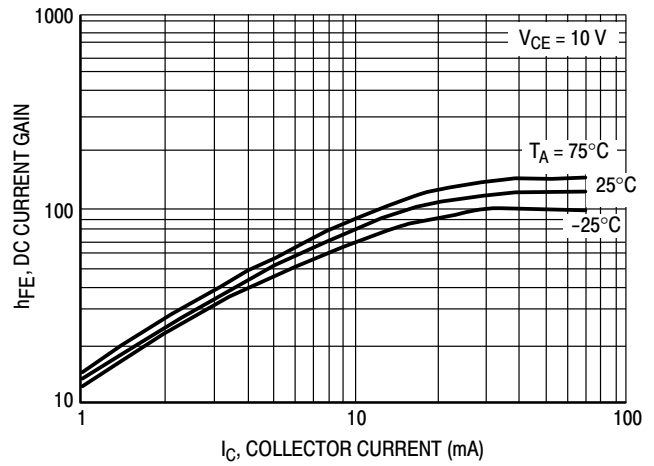

Figure 13. DC Current Gain

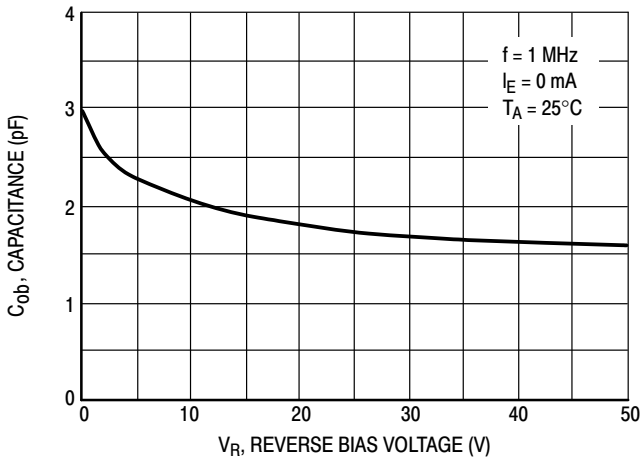

Figure 14. Output Capacitance

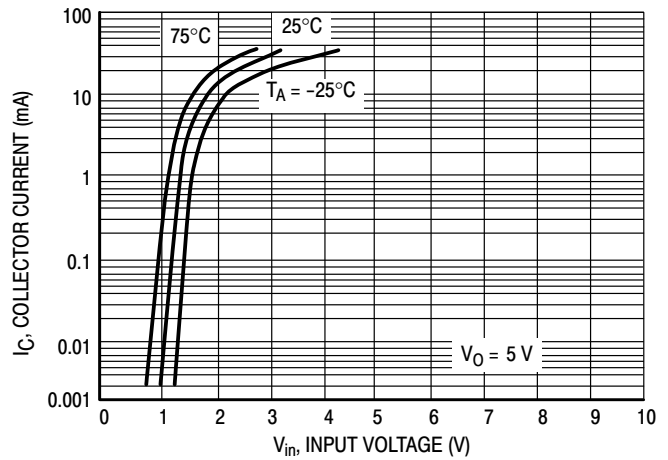

Figure 15. Output Current versus Input Voltage

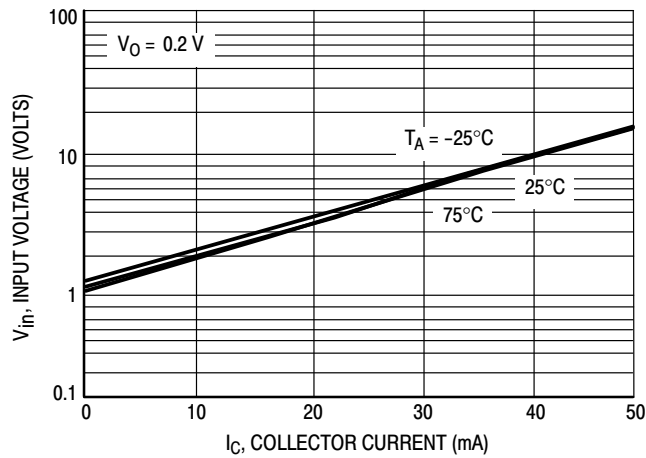

Figure 16. Input Voltage versus Output Current

# EMC2DXV5T1G, EMC3DXV5T1G, EMC4DXV5T1G, EMC5DXV5T1G

## TYPICAL ELECTRICAL CHARACTERISTICS – EMC3DXV5T1 NPN TRANSISTOR

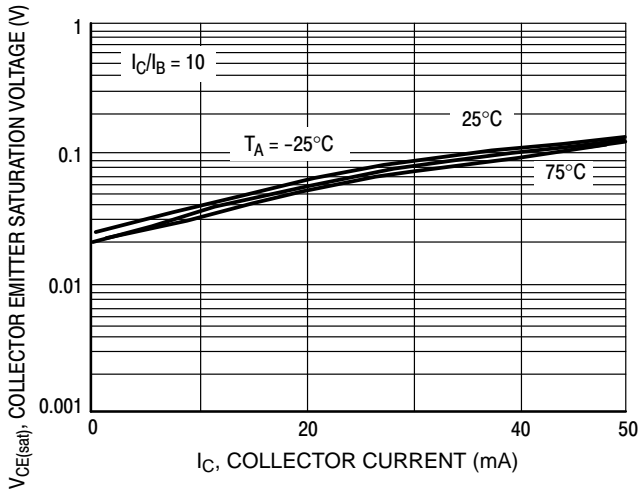

Figure 17.  $V_{CE(sat)}$  versus  $I_C$

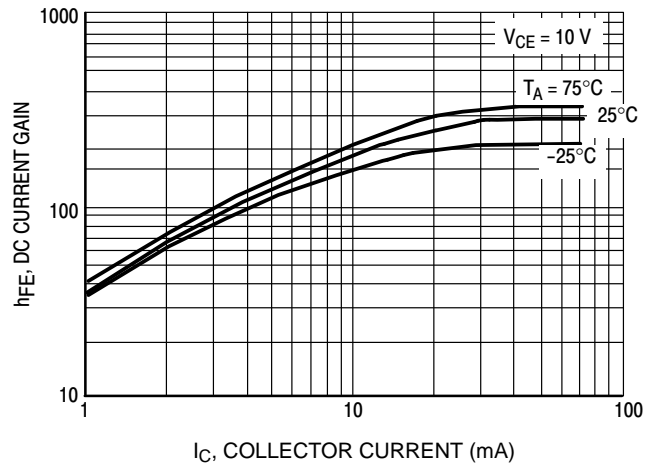

Figure 18. DC Current Gain

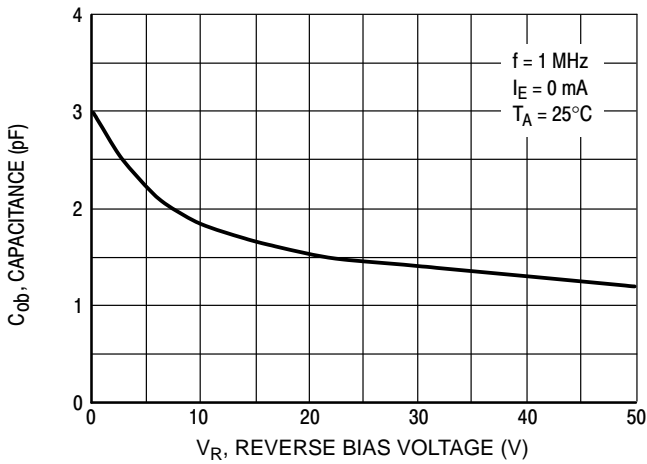

Figure 19. Output Capacitance

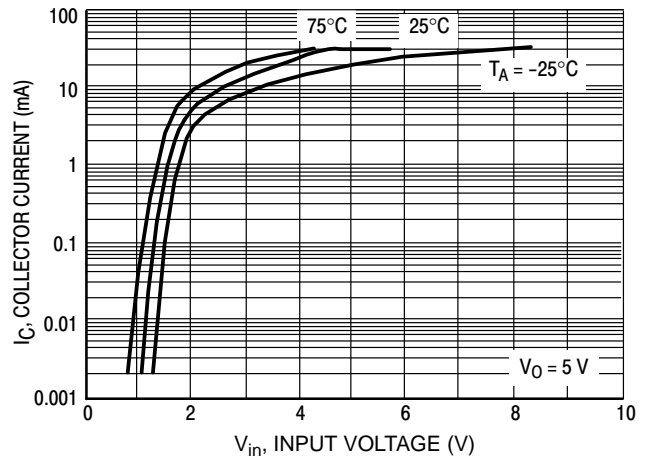

Figure 20. Output Current versus Input Voltage

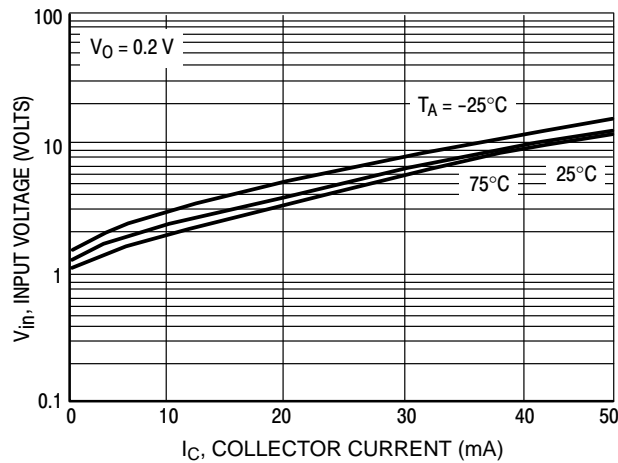

Figure 21. Input Voltage versus Output Current



# EMC2DXV5T1G, EMC3DXV5T1G, EMC4DXV5T1G, EMC5DXV5T1G

## TYPICAL ELECTRICAL CHARACTERISTICS – EMC4DXV5T1 PNP TRANSISTOR

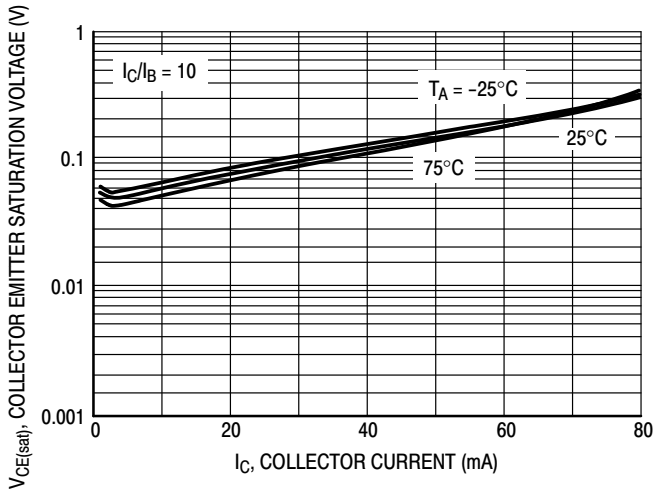

Figure 22.  $V_{CE(sat)}$  versus  $I_C$

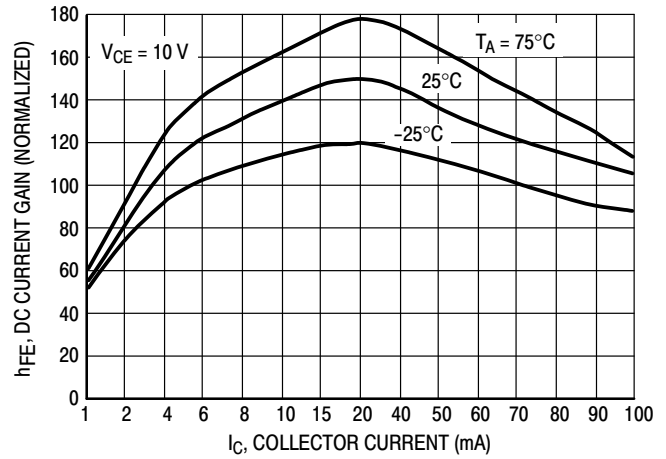

Figure 23. DC Current Gain

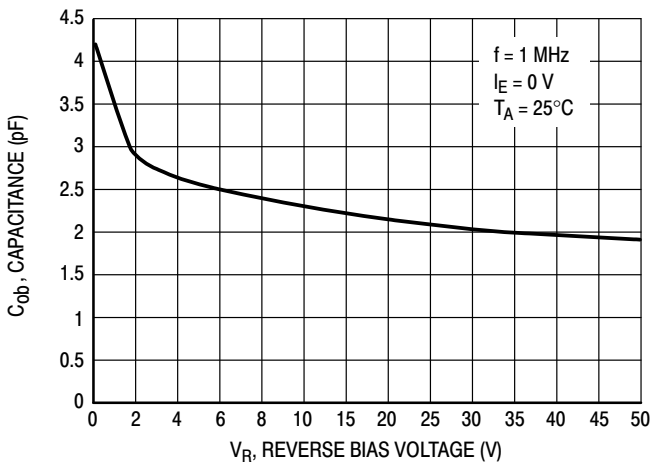

Figure 24. Output Capacitance

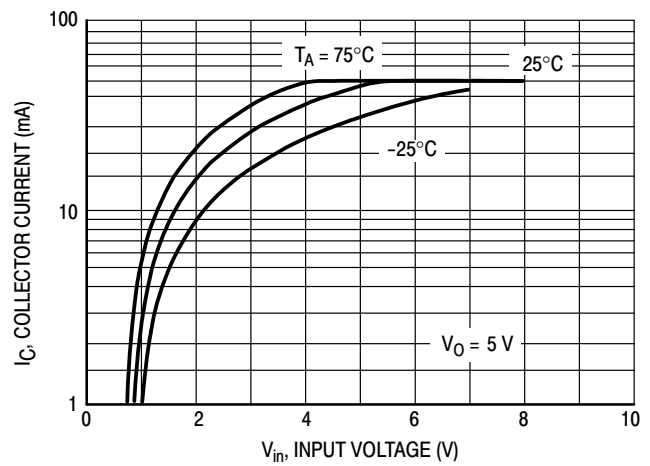

Figure 25. Output Current versus Input Voltage

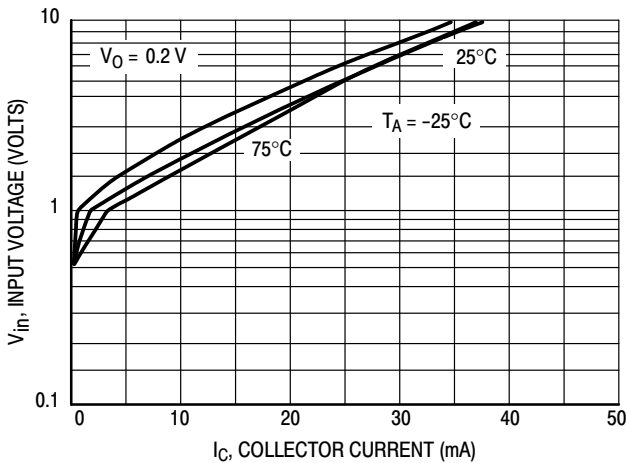

Figure 26. Input Voltage versus Output Current

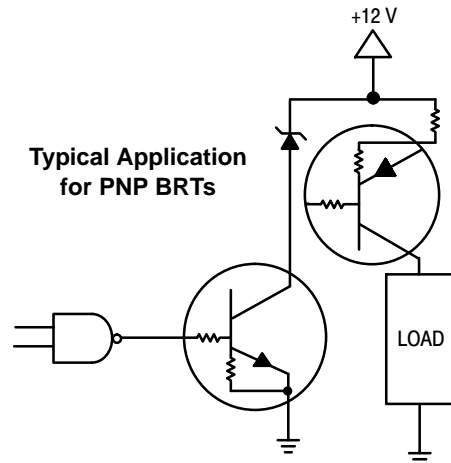

Figure 27. Inexpensive, Unregulated Current Source

# EMC2DXV5T1G, EMC3DXV5T1G, EMC4DXV5T1G, EMC5DXV5T1G

## TYPICAL ELECTRICAL CHARACTERISTICS – EMC5DXV5T1 PNP TRANSISTOR

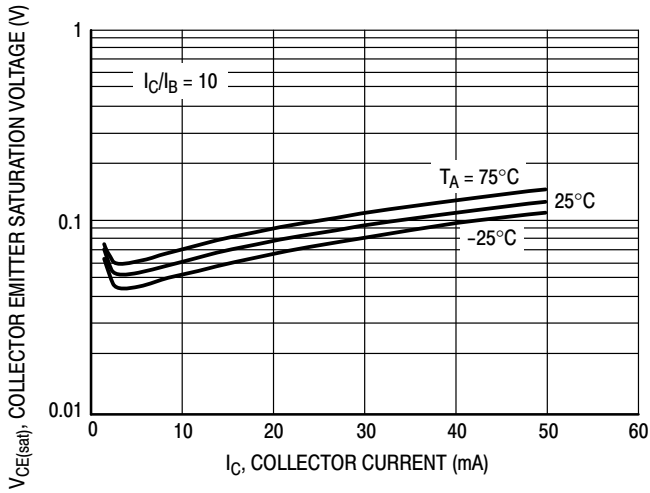

Figure 28.  $V_{CE(sat)}$  versus  $I_C$

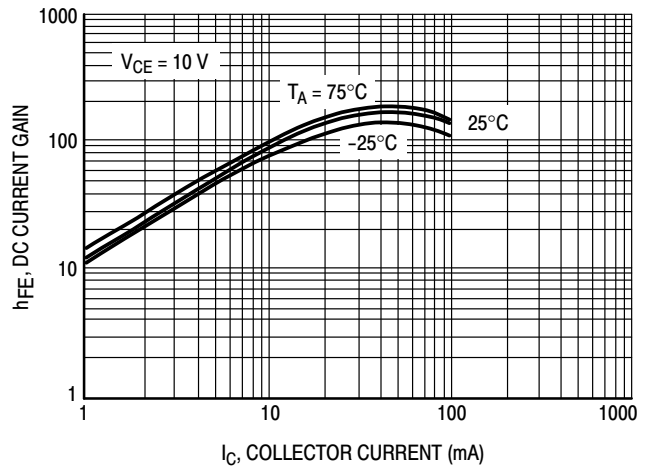

Figure 29. DC Current Gain

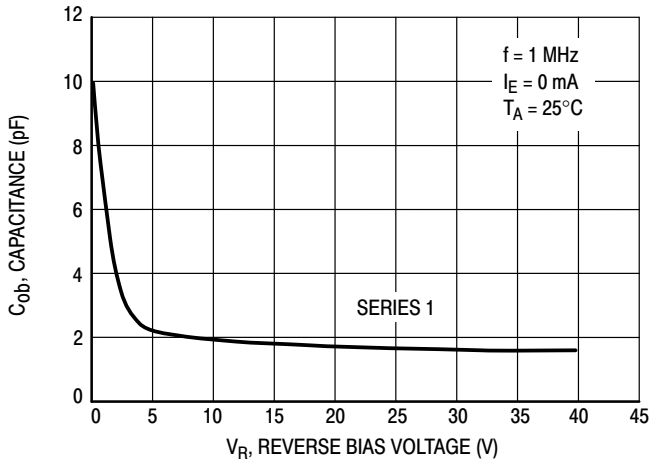

Figure 30. Output Capacitance

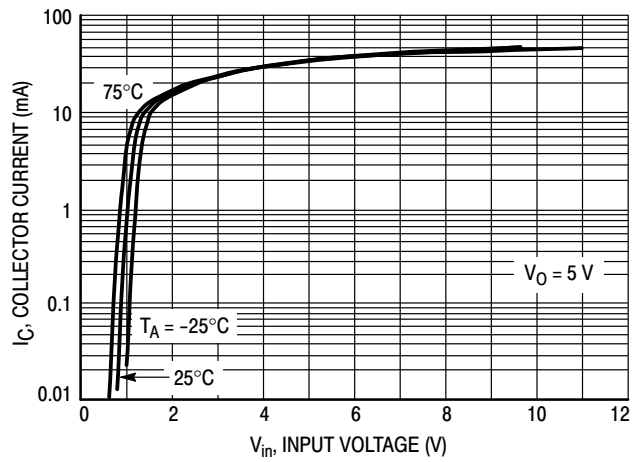

Figure 31. Output Current versus Input Voltage

# EMC2DXV5T1G, EMC3DXV5T1G, EMC4DXV5T1G, EMC5DXV5T1G

## TYPICAL ELECTRICAL CHARACTERISTICS – EMC4DXV5T1, EMC5DXV5T1 NPN TRANSISTOR

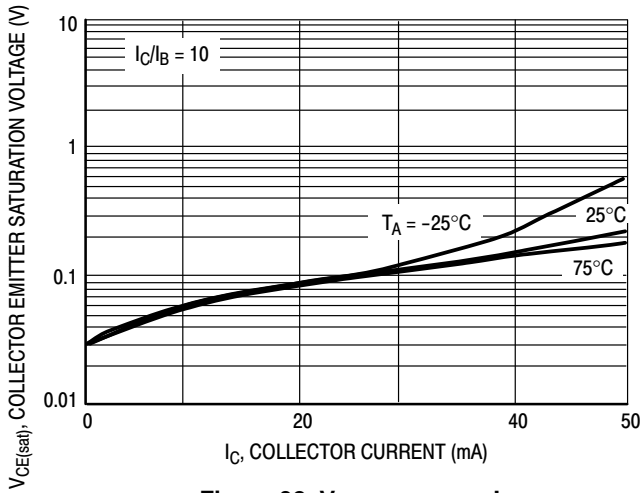

Figure 32.  $V_{CE(sat)}$  versus  $I_C$

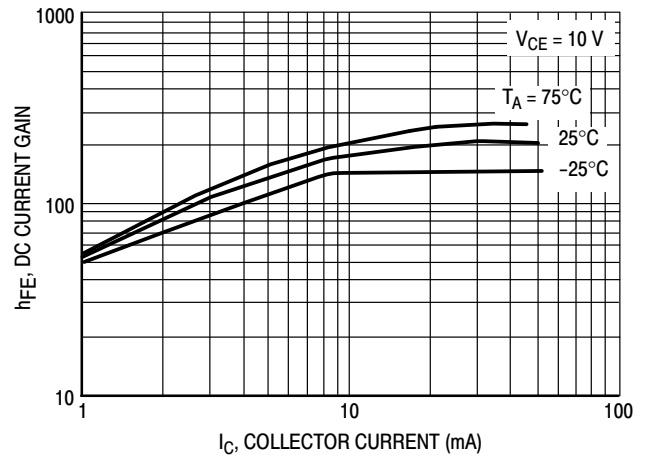

Figure 33. DC Current Gain

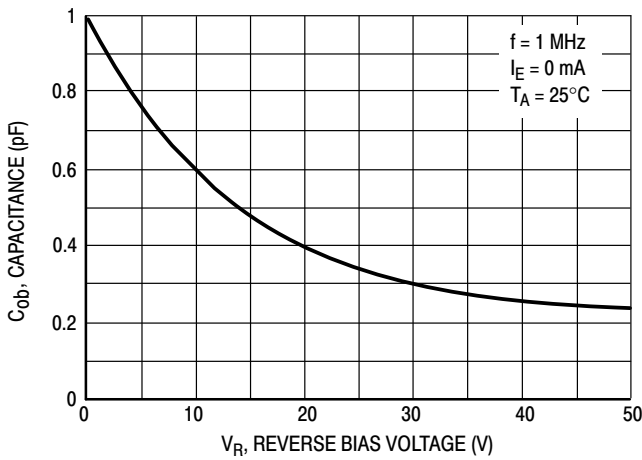

Figure 34. Output Capacitance

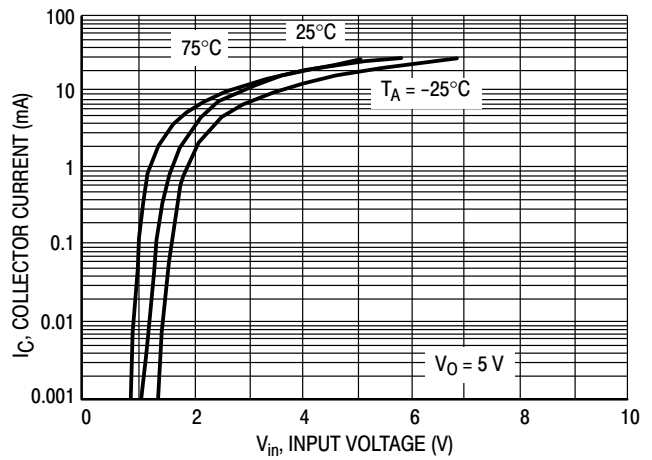

Figure 35. Output Current versus Input Voltage

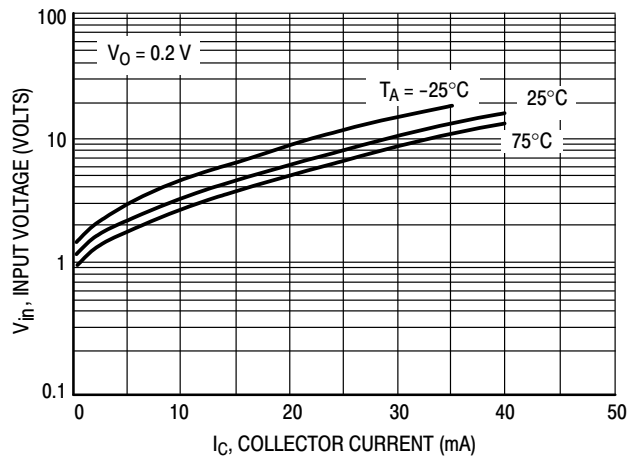

Figure 36. Input Voltage versus Output Current

# MECHANICAL CASE OUTLINE

## PACKAGE DIMENSIONS

ON Semiconductor®



SCALE 4:1

### SOT-553, 5 LEAD CASE 463B ISSUE C

DATE 20 MAR 2013

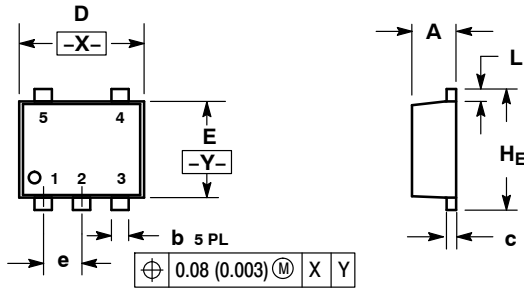

NOTES:

1. DIMENSIONING AND TOLERANCING PER ANSI Y14.5M, 1982.
2. CONTROLLING DIMENSION: MILLIMETERS
3. MAXIMUM LEAD THICKNESS INCLUDES LEAD FINISH THICKNESS. MINIMUM LEAD THICKNESS IS THE MINIMUM THICKNESS OF BASE MATERIAL.

DIM	MILLIMETERS			INCHES		
	MIN	NOM	MAX	MIN	NOM	MAX
A	0.50	0.55	0.60	0.020	0.022	0.024
b	0.17	0.22	0.27	0.007	0.009	0.011
c	0.08	0.13	0.18	0.003	0.005	0.007
D	1.55	1.60	1.65	0.061	0.063	0.065
E	1.15	1.20	1.25	0.045	0.047	0.049
e	0.50 BSC			0.020 BSC		
L	0.10	0.20	0.30	0.004	0.008	0.012
HE	1.55	1.60	1.65	0.061	0.063	0.065

### RECOMMENDED SOLDERING FOOTPRINT\*

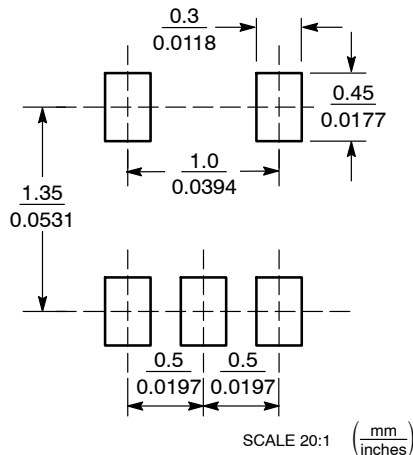

### GENERIC MARKING DIAGRAM\*



- XX = Specific Device Code
- M = Date Code
- = Pb-Free Package

(Note: Microdot may be in either location)

\*This information is generic. Please refer to device data sheet for actual part marking. Pb-Free indicator, "G" or microdot "▪", may or may not be present.

\*For additional information on our Pb-Free strategy and soldering details, please download the ON Semiconductor Soldering and Mounting Techniques Reference Manual, SOLDERRM/D.

STYLE 1:

- PIN 1. BASE
- 2. EMITTER
- 3. BASE
- 4. COLLECTOR
- 5. COLLECTOR

STYLE 2:

- PIN 1. CATHODE
- 2. COMMON ANODE
- 3. CATHODE 2
- 4. CATHODE 3
- 5. CATHODE 4

STYLE 3:

- PIN 1. ANODE 1
- 2. N/C
- 3. ANODE 2
- 4. CATHODE 2
- 5. CATHODE 1

STYLE 4:

- PIN 1. SOURCE 1
- 2. DRAIN 1/2
- 3. SOURCE 1
- 4. GATE 1
- 5. GATE 2

STYLE 5:

- PIN 1. ANODE
- 2. EMITTER
- 3. BASE
- 4. COLLECTOR
- 5. CATHODE

STYLE 6:

- PIN 1. EMITTER 2
- 2. BASE 2
- 3. EMITTER 1
- 4. COLLECTOR 1
- 5. COLLECTOR 2/BASE 1

STYLE 7:

- PIN 1. BASE
- 2. EMITTER
- 3. BASE
- 4. COLLECTOR
- 5. COLLECTOR

STYLE 8:

- PIN 1. CATHODE
- 2. COLLECTOR
- 3. N/C
- 4. BASE
- 5. EMITTER

STYLE 9:

- PIN 1. ANODE
- 2. CATHODE
- 3. ANODE
- 4. ANODE
- 5. ANODE

DOCUMENT NUMBER:	98AON11127D	Electronic versions are uncontrolled except when accessed directly from the Document Repository. Printed versions are uncontrolled except when stamped "CONTROLLED COPY" in red.
STATUS:	ON SEMICONDUCTOR STANDARD	
NEW STANDARD:		
DESCRIPTION:	SOT-553, 5 LEAD	PAGE 1 OF 2



ISSUE	REVISION	DATE
A	ADDED STYLES 3-9. REQ. BY D. BARLOW	11 NOV 2003
B	ADDED NOMINAL VALUES AND UPDATED GENERIC MARKING DIAGRAM. REQ. BY HONG XIAO	27 MAY 2005
C	UPDATED DIMENSIONS D, E, AND HE. REQ. BY J. LETTERMAN.	20 MAR 2013

ON Semiconductor and  are registered trademarks of Semiconductor Components Industries, LLC (SCILLC). SCILLC reserves the right to make changes without further notice to any products herein. SCILLC makes no warranty, representation or guarantee regarding the suitability of its products for any particular purpose, nor does SCILLC assume any liability arising out of the application or use of any product or circuit, and specifically disclaims any and all liability, including without limitation special, consequential or incidental damages. "Typical" parameters which may be provided in SCILLC data sheets and/or specifications can and do vary in different applications and actual performance may vary over time. All operating parameters, including "Typicals" must be validated for each customer application by customer's technical experts. SCILLC does not convey any license under its patent rights nor the rights of others. SCILLC products are not designed, intended, or authorized for use as components in systems intended for surgical implant into the body, or other applications intended to support or sustain life, or for any other application in which the failure of the SCILLC product could create a situation where personal injury or death may occur. Should Buyer purchase or use SCILLC products for any such unintended or unauthorized application, Buyer shall indemnify and hold SCILLC and its officers, employees, subsidiaries, affiliates, and distributors harmless against all claims, costs, damages, and expenses, and reasonable attorney fees arising out of, directly or indirectly, any claim of personal injury or death associated with such unintended or unauthorized use, even if such claim alleges that SCILLC was negligent regarding the design or manufacture of the part. SCILLC is an Equal Opportunity/Affirmative Action Employer. This literature is subject to all applicable copyright laws and is not for resale in any manner.

ON Semiconductor and  are trademarks of Semiconductor Components Industries, LLC dba ON Semiconductor or its subsidiaries in the United States and/or other countries. ON Semiconductor owns the rights to a number of patents, trademarks, copyrights, trade secrets, and other intellectual property. A listing of ON Semiconductor's product/patent coverage may be accessed at [www.onsemi.com/site/pdf/Patent-Marking.pdf](http://www.onsemi.com/site/pdf/Patent-Marking.pdf). ON Semiconductor reserves the right to make changes without further notice to any products herein. ON Semiconductor makes no warranty, representation or guarantee regarding the suitability of its products for any particular purpose, nor does ON Semiconductor assume any liability arising out of the application or use of any product or circuit, and specifically disclaims any and all liability, including without limitation special, consequential or incidental damages. Buyer is responsible for its products and applications using ON Semiconductor products, including compliance with all laws, regulations and safety requirements or standards, regardless of any support or applications information provided by ON Semiconductor. "Typical" parameters which may be provided in ON Semiconductor data sheets and/or specifications can and do vary in different applications and actual performance may vary over time. All operating parameters, including "Typicals" must be validated for each customer application by customer's technical experts. ON Semiconductor does not convey any license under its patent rights nor the rights of others. ON Semiconductor products are not designed, intended, or authorized for use as a critical component in life support systems or any FDA Class 3 medical devices or medical devices with a same or similar classification in a foreign jurisdiction or any devices intended for implantation in the human body. Should Buyer purchase or use ON Semiconductor products for any such unintended or unauthorized application, Buyer shall indemnify and hold ON Semiconductor and its officers, employees, subsidiaries, affiliates, and distributors harmless against all claims, costs, damages, and expenses, and reasonable attorney fees arising out of, directly or indirectly, any claim of personal injury or death associated with such unintended or unauthorized use, even if such claim alleges that ON Semiconductor was negligent regarding the design or manufacture of the part. ON Semiconductor is an Equal Opportunity/Affirmative Action Employer. This literature is subject to all applicable copyright laws and is not for resale in any manner.

## PUBLICATION ORDERING INFORMATION

### LITERATURE FULFILLMENT:

Email Requests to: [orderlit@onsemi.com](mailto:orderlit@onsemi.com)

ON Semiconductor Website: [www.onsemi.com](http://www.onsemi.com)

### TECHNICAL SUPPORT

North American Technical Support:  
Voice Mail: 1 800-282-9855 Toll Free USA/Canada  
Phone: 011 421 33 790 2910

### Europe, Middle East and Africa Technical Support:

Phone: 00421 33 790 2910

For additional information, please contact your local Sales Representative