

ON Semiconductor

Is Now

onsemi™

To learn more about onsemi™, please visit our website at
www.onsemi.com

onsemi and **onsemi** and other names, marks, and brands are registered and/or common law trademarks of Semiconductor Components Industries, LLC dba "**onsemi**" or its affiliates and/or subsidiaries in the United States and/or other countries. **onsemi** owns the rights to a number of patents, trademarks, copyrights, trade secrets, and other intellectual property. A listing of **onsemi** product/patent coverage may be accessed at www.onsemi.com/site/pdf/Patent-Marking.pdf. **onsemi** reserves the right to make changes at any time to any products or information herein, without notice. The information herein is provided "as-is" and **onsemi** makes no warranty, representation or guarantee regarding the accuracy of the information, product features, availability, functionality, or suitability of its products for any particular purpose, nor does **onsemi** assume any liability arising out of the application or use of any product or circuit, and specifically disclaims any and all liability, including without limitation special, consequential or incidental damages. Buyer is responsible for its products and applications using **onsemi** products, including compliance with all laws, regulations and safety requirements or standards, regardless of any support or applications information provided by **onsemi**. "Typical" parameters which may be provided in **onsemi** data sheets and/or specifications can and do vary in different applications and actual performance may vary over time. All operating parameters, including "Typicals" must be validated for each customer application by customer's technical experts. **onsemi** does not convey any license under any of its intellectual property rights nor the rights of others. **onsemi** products are not designed, intended, or authorized for use as a critical component in life support systems or any FDA Class 3 medical devices or medical devices with a same or similar classification in a foreign jurisdiction or any devices intended for implantation in the human body. Should Buyer purchase or use **onsemi** products for any such unintended or unauthorized application, Buyer shall indemnify and hold **onsemi** and its officers, employees, subsidiaries, affiliates, and distributors harmless against all claims, costs, damages, and expenses, and reasonable attorney fees arising out of, directly or indirectly, any claim of personal injury or death associated with such unintended or unauthorized use, even if such claim alleges that **onsemi** was negligent regarding the design or manufacture of the part. **onsemi** is an Equal Opportunity/Affirmative Action Employer. This literature is subject to all applicable copyright laws and is not for resale in any manner. Other names and brands may be claimed as the property of others.

High Efficiency Rectifiers 2.0 A Glass Passivated



EGP20A - EGP20K

Features

- Glass–Passivated Cavity–Free Junction
- High Surge Current Capability
- Low Leakage Current
- Super–Fast Recovery Time for High Efficiency
- Low Forward Voltage, High Current Capability

ON Semiconductor®

www.onsemi.com



AXIAL LEAD DO 204
CASE 017AJ

MARKING DIAGRAM



EGP20K = Specific Device Code
 \$Y = ON Semiconductor Logo
 &Z = Assembly Code
 &3 = Date Code

ABSOLUTE MAXIMUM RATINGS $T_A = 25^\circ\text{C}$ unless otherwise noted

Symbol	Parameter	Value	Units
$I_{F(AV)}$	Average Rectified Current 0.375 inch lead length at $T_A = 55^\circ\text{C}$	2.0	A
I_{FSM}	Peak Forward Surge Current 8.3 ms single half–sine–wave Superimposed on rated load (JEDEC method)	75	A
T_J, T_{STG}	Junction and Storage Temperature Range	–65 to 150	$^\circ\text{C}$

Stresses exceeding those listed in the Maximum Ratings table may damage the device. If any of these limits are exceeded, device functionality should not be assumed, damage may occur and reliability may be affected.

THERMAL CHARACTERISTICS

Symbol	Parameter	Value	Units
P_D	Total Device Dissipation	3.13	W
	Derate above 25°C	25	mW°C
$R_{\theta JA}$	Thermal Resistance, Junction to Ambient	40	$^\circ\text{C}/\text{W}$
$R_{\theta JL}$	Thermal Resistance, Junction to Lead	15	$^\circ\text{C}/\text{W}$

ELECTRICAL CHARACTERISTICS $T_A = 25^\circ\text{C}$ unless otherwise noted

Parameter	Device								Units
	20A	20B	20C	20D	20F	20G	20J	20K	
Peak Repetitive Reverse Voltage	50	100	150	200	300	400	600	800	V
Maximum RMS Voltage	35	70	105	140	210	280	420	560	V
DC Reverse Voltage (Rated V_R)	50	100	150	200	300	400	600	800	V
Maximum Reverse Current at Rated V_R	$T_A = 25^\circ\text{C}$	5.0							μA
	$T_A = 125^\circ\text{C}$	100							μA
Maximum Reverse Recovery Time $I_F = 0.5\text{ A}, I_R = 1.0\text{ A}, I_{rr} = 0.25\text{ A}$	50						75		nS
Maximum Forward Voltage @ 2.0 A	0.95			1.25		1.7			V
Typical Junction Capacitance $V_R = 4.0\text{ V}, f = 1.0\text{ MHz}$	70			45					pF

Product parametric performance is indicated in the Electrical Characteristics for the listed test conditions, unless otherwise noted. Product performance may not be indicated by the Electrical Characteristics if operated under different conditions.

*Pulse Test: Pulse Width $\leq 300\ \mu\text{s}$, Duty Cycle $\leq 2\%$.

EGP20A – EGP20K

TYPICAL PERFORMANCE CHARACTERISTICS

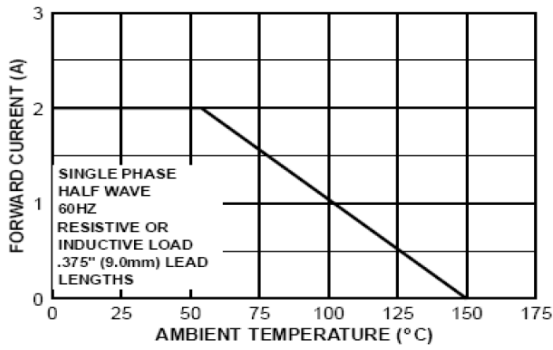

Figure 1. Forward Current Derating Curve

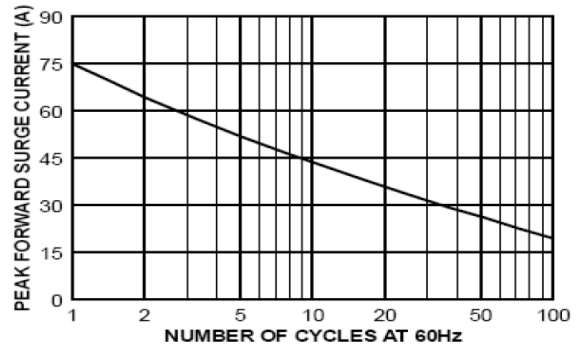

Figure 2. Non-Repetitive Surge Current

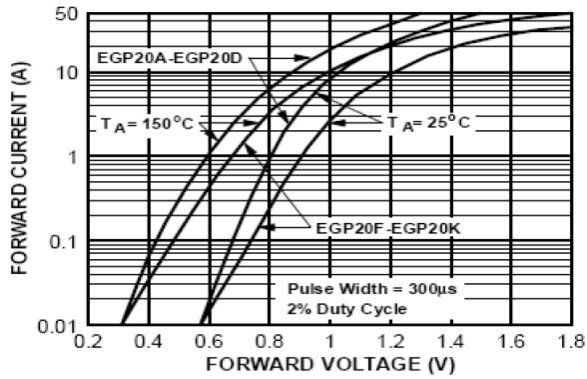

Figure 3. Forward Characteristics

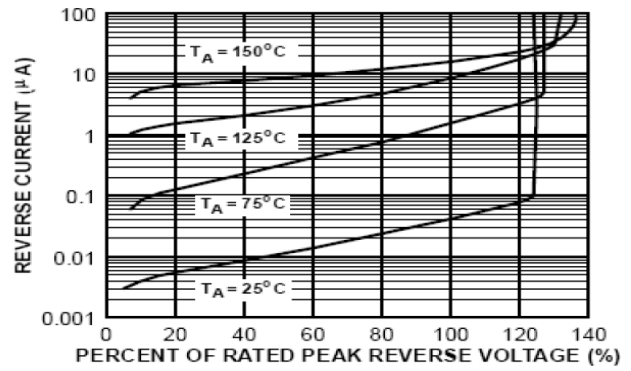

Figure 4. Reverse Characteristics

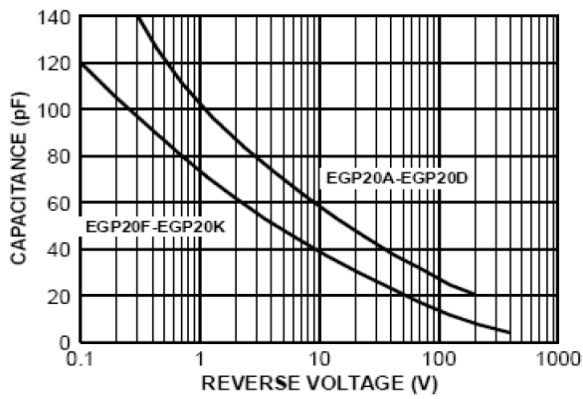
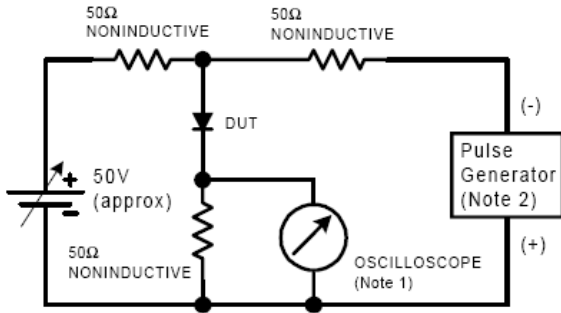

Figure 5. Junction Capacitance

EGP20A – EGP20K

Reverse Recovery Time Characteristic and Test Circuit Diagram



NOTES:

1. Rise time = 7.0 ns max; Input impedance = 1.0 megaohm 22 pf.
2. Rise time = 10 ns max; Source impedance = 50 ohms.

Figure 6.

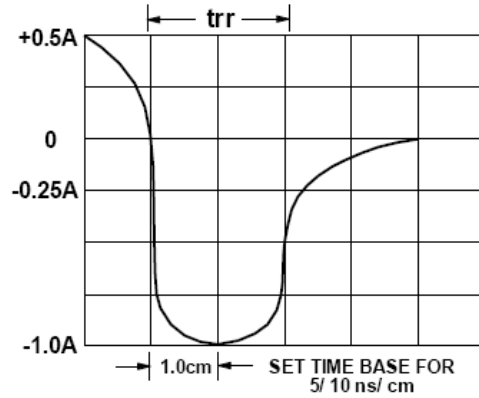

Figure 7.

ORDERING INFORMATION

Device	Package	Shipping
EGP20K	Axial Lead / DO-204 CASE 017AJ	4000 / Tape & Reel

†For information on tape and reel specifications, including part orientation and tape sizes, please refer to our Tape and Reel Packaging Specifications Brochure, BRD8011/D.

AXIAL LEAD DO 204
CASE 017AJ
ISSUE O

DATE 30 NOV 2016

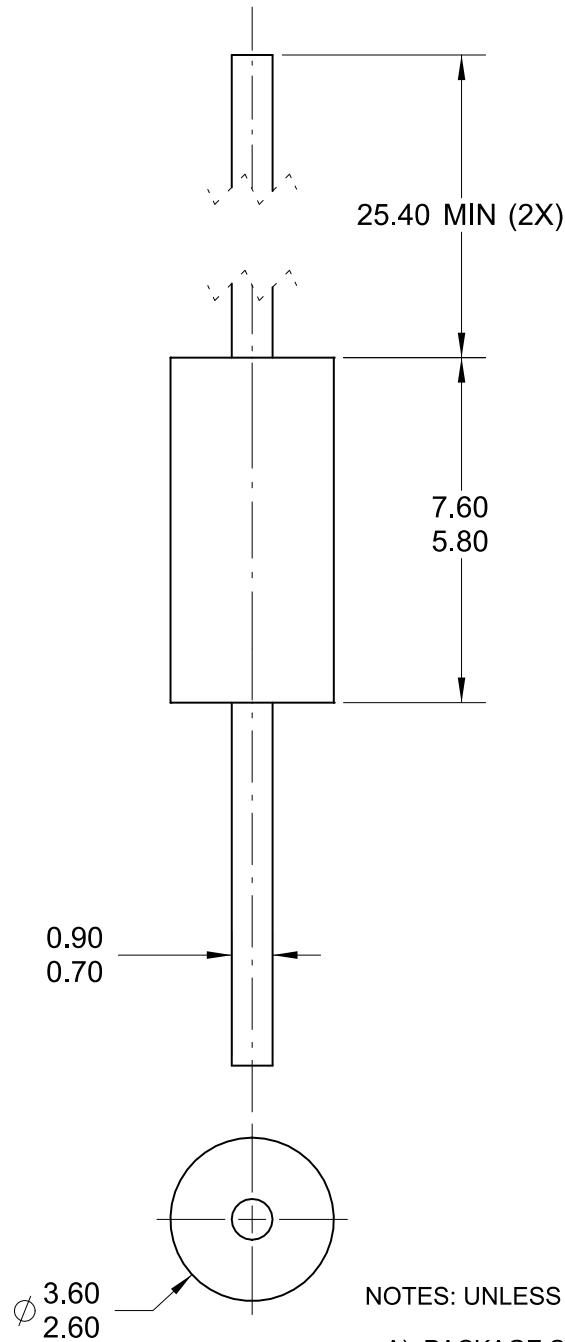

NOTES: UNLESS OTHERWISE SPECIFIED

- A) PACKAGE STANDARD REFERENCE:
JEDEC DO-204 VARIATION AC.
- B) PLASTIC PACKAGE BODY.
- D) ALL DIMENSIONS ARE IN MILLIMETERS.

DOCUMENT NUMBER:	98AON13437G	Electronic versions are uncontrolled except when accessed directly from the Document Repository. Printed versions are uncontrolled except when stamped "CONTROLLED COPY" in red.
DESCRIPTION:	AXIAL LEAD DO 204	PAGE 1 OF 1

ON Semiconductor and  are trademarks of Semiconductor Components Industries, LLC dba ON Semiconductor or its subsidiaries in the United States and/or other countries. ON Semiconductor reserves the right to make changes without further notice to any products herein. ON Semiconductor makes no warranty, representation or guarantee regarding the suitability of its products for any particular purpose, nor does ON Semiconductor assume any liability arising out of the application or use of any product or circuit, and specifically disclaims any and all liability, including without limitation special, consequential or incidental damages. ON Semiconductor does not convey any license under its patent rights nor the rights of others.

ON Semiconductor and  are trademarks of Semiconductor Components Industries, LLC dba ON Semiconductor or its subsidiaries in the United States and/or other countries. ON Semiconductor owns the rights to a number of patents, trademarks, copyrights, trade secrets, and other intellectual property. A listing of ON Semiconductor's product/patent coverage may be accessed at www.onsemi.com/site/pdf/Patent-Marking.pdf. ON Semiconductor reserves the right to make changes without further notice to any products herein. ON Semiconductor makes no warranty, representation or guarantee regarding the suitability of its products for any particular purpose, nor does ON Semiconductor assume any liability arising out of the application or use of any product or circuit, and specifically disclaims any and all liability, including without limitation special, consequential or incidental damages. Buyer is responsible for its products and applications using ON Semiconductor products, including compliance with all laws, regulations and safety requirements or standards, regardless of any support or applications information provided by ON Semiconductor. "Typical" parameters which may be provided in ON Semiconductor data sheets and/or specifications can and do vary in different applications and actual performance may vary over time. All operating parameters, including "Typicals" must be validated for each customer application by customer's technical experts. ON Semiconductor does not convey any license under its patent rights nor the rights of others. ON Semiconductor products are not designed, intended, or authorized for use as a critical component in life support systems or any FDA Class 3 medical devices or medical devices with a same or similar classification in a foreign jurisdiction or any devices intended for implantation in the human body. Should Buyer purchase or use ON Semiconductor products for any such unintended or unauthorized application, Buyer shall indemnify and hold ON Semiconductor and its officers, employees, subsidiaries, affiliates, and distributors harmless against all claims, costs, damages, and expenses, and reasonable attorney fees arising out of, directly or indirectly, any claim of personal injury or death associated with such unintended or unauthorized use, even if such claim alleges that ON Semiconductor was negligent regarding the design or manufacture of the part. ON Semiconductor is an Equal Opportunity/Affirmative Action Employer. This literature is subject to all applicable copyright laws and is not for resale in any manner.

PUBLICATION ORDERING INFORMATION

LITERATURE FULFILLMENT:

Email Requests to: orderlit@onsemi.com

ON Semiconductor Website: www.onsemi.com

TECHNICAL SUPPORT

North American Technical Support:
Voice Mail: 1 800-282-9855 Toll Free USA/Canada
Phone: 011 421 33 790 2910

Europe, Middle East and Africa Technical Support:

Phone: 00421 33 790 2910

For additional information, please contact your local Sales Representative