

Automotive Logic Gates

NLV18VHC1Gxx, NLV18VHC1GTxx

The NLV18VHC1Gxx and NLV18VHC1GTxx are automotive-grade CMOS logic gates.

The NLV18VHC1Gxx devices have CMOS input voltage levels while the NLV18VHC1GTxx devices have TTL input voltage levels.

Features

- High Speed: $t_{PD} = 7$ ns (Typ) at $V_{CC} = 5.5$ V
- Low Power Dissipation: $I_{CC} = 1$ μ A (Max) at $T_A = 25^\circ$ C
- High Noise Immunity
- Balanced Propagation Delays ($t_{PLH} = t_{PHL}$)
- Symmetrical Output Impedance ($I_{OH} = I_{OL} = 8$ mA)
- Operating Temperature: -55° C to $+125^\circ$ C
AEC Grade 1-Compliant: -40° C to $+125^\circ$ C
- Tiny SC-88A Package (other package offerings may be available upon request)
- AEC-Q100 Qualified and PPAP Capable
- These Devices are Pb-Free, Halogen Free/BFR Free and RoHS Compliant

FUNCTION LIST

xx	Function
00	2-Input NAND
02	2-Input NOR
04	Inverter
05	Open-Drain Inverter
07	Open-Drain Buffer
08	2-Input AND
09	2-Input AND Gate with Open-Drain Output
14	Schmitt-Trigger Inverter
17	Schmitt-Trigger Buffer
32	2-Input OR
50	Buffer
86	2-Input XOR
125	Tri-State Buffer
126	Tri-State Buffer
132	2-Input Schmitt-Trigger NAND
U04	Unbuffered Inverter

This document contains information on some products that are still under development. ON Semiconductor reserves the right to change or discontinue these products without notice.



ON Semiconductor®

www.onsemi.com



**SC-88A
DF SUFFIX
CASE 419A**

MARKING DIAGRAM

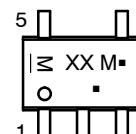

XX = Device Code
M = Date Code*
▪ = Pb-Free Package

(Note: Microdot may be in either location)

*Date Code orientation and/or position may vary depending upon manufacturing location.

ORDERING INFORMATION

See detailed ordering and shipping information on page 11 of this data sheet.

NLV18VHC1Gxx, NLV18VHC1GTxx

FUNCTIONS AND FUNCTION TABLES – BUFFERS AND INVERTERS

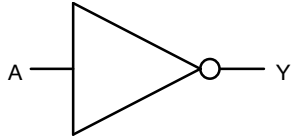

04 – Inverter
U04 – Unbuffered Inverter

A	Y
0	1
1	0

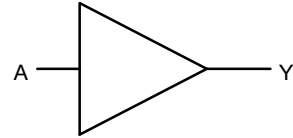

50 – Buffer

A	Y
0	0
1	1

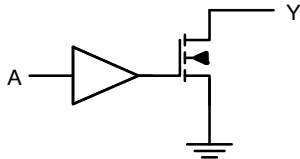

05 – Open-Drain Inverter

A	Y
0	Hi-Z
1	0

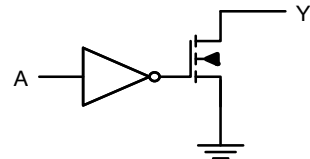

07 – Open-Drain Buffer

A	Y
0	0
1	Hi-Z

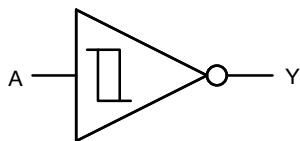

14 – Schmitt-Trigger Inverter

A	Y
0	1
1	0

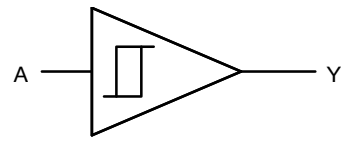

17 – Schmitt-Trigger Buffer

A	Y
0	0
1	1

Pin Assignment

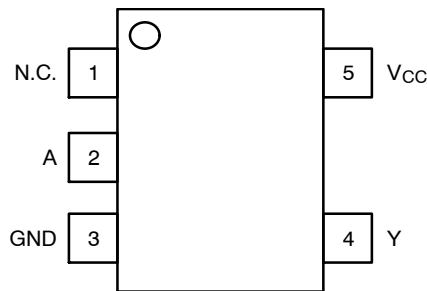

Pinout (Buffers and Inverters)

Pin	Name	Description
1	N.C.	No Connection
2	A	Input
3	GND	Ground
4	Y	Output
5	V _{CC}	Supply

NLV18VHC1Gxx, NLV18VHC1GTxx

FUNCTIONS AND FUNCTION TABLES – TRI-STATE BUFFERS AND BUS DRIVERS

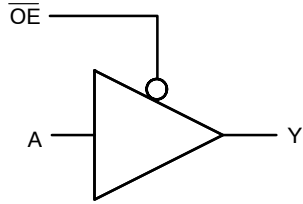

125 - Tri-State Buffer

OE	A	Y
0	0	0
0	1	1
1	X	Hi-Z

X = Don't Care

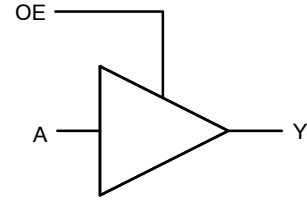

126 - Tri-State Buffer

OE	A	Y
0	X	Hi-Z
1	0	0
1	1	1

X = Don't Care

Pin Assignments

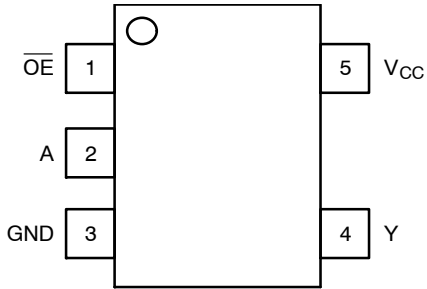

Pinout (125)

Pin	Name	Description
1	OE	Enable (Active-Low)
2	A	Input
3	GND	Ground
4	Y	Output
5	V _{CC}	Supply

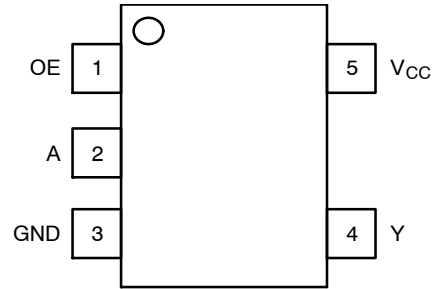

Pinout (126)

Pin	Name	Description
1	OE	Enable (Active-High)
2	A	Input
3	GND	Ground
4	Y	Output
5	V _{CC}	Supply

NLV18VHC1Gxx, NLV18VHC1GTxx

FUNCTIONS AND FUNCTION TABLES - GATES

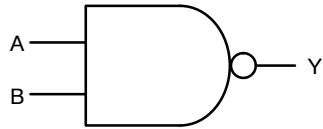

00 - NAND

A	B	Y
0	0	1
0	1	1
1	0	1
1	1	0

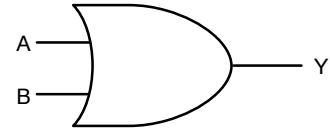

32 - OR

A	B	Y
0	0	0
0	1	1
1	0	1
1	1	1

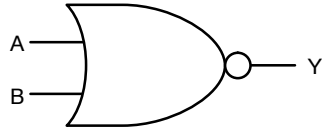

02 - NOR

A	B	Y
0	0	1
0	1	0
1	0	0
1	1	0

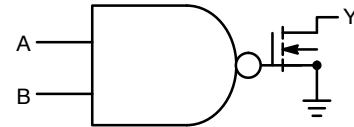

09 - AND with Open-Drain Output

A	B	Y
0	0	0
0	1	0
1	0	0
1	1	Hi-Z

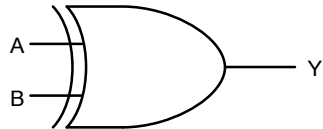

86 - XOR

A	B	Y
0	0	0
0	1	1
1	0	1
1	1	0

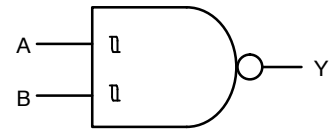

132 - NAND, Schmitt-Trigger

A	B	Y
0	0	1
0	1	1
1	0	1
1	1	0

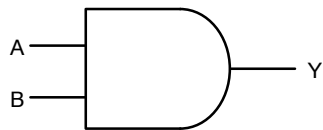

08 - AND

A	B	Y
0	0	0
0	1	0
1	0	0
1	1	1

NLV18VHC1Gxx, NLV18VHC1GTxx

Pin Assignment

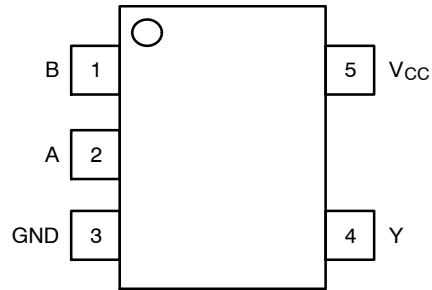

Pinout (Gates)

Pin	Name	Description
1	B	Input
2	A	Input
3	GND	Ground
4	Y	Output
5	Vcc	Supply

NLV18VHC1Gxx, NLV18VHC1GTxx

Table 1. MAXIMUM RATINGS

Symbol	Parameter	Value	Unit	
V _{CC}	DC Supply Voltage	-0.5 to +6.5	V	
V _{IN}	DC Input Voltage	-0.5 to +6.5	V	
V _{OUT}	DC Output Voltage (U04)	-0.5 to V _{CC} +0.5	V	
	DC Output Voltage (Other functions)	Active-Mode (High or Low State)		-0.5 to V _{CC} +0.5
		Tri-State Mode (Note 1)		-0.5 to +6.5
Power-Down Mode (V _{CC} = 0 V)		-0.5 to +6.5		
I _{IK}	DC Input Diode Current	-20	mA	
I _{OK}	DC Output Diode Current (U04)	±20	mA	
	DC Output Diode Current (Other functions)	-20		
I _{OUT}	DC Output Source/Sink Current	±25	mA	
I _{CC} or I _{GND}	DC Supply Current Per Supply Pin or Ground Pin	±50	mA	
T _{STG}	Storage Temperature Range	-65 to +150	°C	
T _L	Lead Temperature, 1 mm from Case for 10 Seconds	260	°C	
T _J	Junction Temperature Under Bias	+150	°C	
θ _{JA}	Thermal Resistance (Note 2)	659	°C/W	
P _D	Power Dissipation in Still Air at 85°C	190	mW	
MSL	Moisture Sensitivity	Level 1		
F _R	Flammability Rating	Oxygen Index: 28 to 34	UL 94 V-0 @ 0.125 in	
V _{ESD}	ESD Withstand Voltage (Note 3)	Human Body Model	2000	V
		Charged Device Model	1000	
I _{LATCHUP}	Latchup Performance (Note 4)	±100	mA	

Stresses exceeding those listed in the Maximum Ratings table may damage the device. If any of these limits are exceeded, device functionality should not be assumed, damage may occur and reliability may be affected.

1. Applicable to devices with outputs that may be tri-stated.
2. Measured with minimum pad spacing on an FR4 board, using 10 mm-by-1 inch, 20 ounce copper trace with no air flow.
3. HBM tested to EIA / JESD22-A114-A. CDM tested to JESD22-C101-A. JEDEC recommends that ESD qualification to EIA/JESD22-A115A (Machine Model) be discontinued.
4. Tested to EIA/JESD78 Class II.

Table 2. RECOMMENDED OPERATING CONDITIONS

Symbol	Parameter	Min	Max	Unit	
V _{CC}	Positive DC Supply Voltage	NLV18VHC1Gxx	2.0	5.5	V
		NLV18VHC1GTxx	4.5	5.5	
V _{IN}	Digital Input Voltage	0	5.5	V	
V _{OUT}	DC Output Voltage (U04)	0	V _{CC}	V	
	DC Output Voltage (Other functions)	Active-Mode (High or Low State)	0		V _{CC}
		Tri-State Mode (Note 1)	0		5.5
		Power-Down Mode (V _{CC} = 0 V)	0		5.5
T _A	Operating Free-Air Temperature	-55	+125	°C	
t _r , t _f	Input Transition Rise or Fall Rate			ns/V	
	Functions 14 and 17	0	No Limit		
	All Other Functions	V _{CC} = 2.0 V	0		20
		V _{CC} = 2.3 V to 2.7 V	0		20
		V _{CC} = 3.0 V to 3.6 V	0		10
V _{CC} = 4.5 V to 5.5 V		0	5		

Functional operation above the stresses listed in the Recommended Operating Ranges is not implied. Extended exposure to stresses beyond the Recommended Operating Ranges limits may affect device reliability.

NLV18VHC1Gxx, NLV18VHC1GTxx

Table 3. DC ELECTRICAL CHARACTERISTICS (NLV18VHC1Gxx)

Symbol	Parameter	Conditions	V _{CC} (V)	T _A = 25°C			T _A = -40°C to 85°C		T _A = -55°C to +125°C		Unit
				Min	Typ	Max	Min	Max	Min	Max	
NLV18VHC1G14, NLV18VHC1G17 and NLV18VHC1G132											
V _{T+}	Positive-Going Threshold		2.0	-	1.3	1.5	-	1.5	-	1.5	V
			3.0	-	2.0	2.20	-	2.20	-	2.20	
			4.5	-	3.0	3.15	-	3.15	-	3.15	
			5.5	-	3.6	3.85	-	3.85	-	3.85	
V _{T-}	Negative-Going Threshold		2.0	0.5	0.75	-	0.5	-	0.5	-	V
			3.0	0.9	1.5	-	0.9	-	0.9	-	
			4.5	1.35	2.3	-	1.35	-	1.35	-	
			5.5	1.65	2.9	-	1.65	-	1.65	-	
V _H	Hysteresis Voltage		2.0	0.2	0.56	1.0	0.2	1.0	0.2	1.0	V
			3.0	0.3	0.57	1.2	0.3	1.2	0.3	1.2	
			4.5	0.4	0.67	1.4	0.4	1.4	0.4	1.4	
			5.5	0.5	0.74	1.6	0.5	1.6	0.5	1.6	
NLV18VHC1GU04 (Under Development)											
V _{IH}	High- Level Input Voltage		2.0	1.7	-	-	1.7	-	1.7	-	V
			3.0	2.4	-	-	2.4	-	2.4	-	
			4.5	3.6	-	-	3.6	-	3.6	-	
			5.5	4.4	-	-	4.4	-	4.4	-	
V _{IL}	Low- Level Input Voltage		2.0	-	-	0.3	-	0.3	-	0.3	V
			3.0	-	-	0.6	-	0.6	-	0.6	
			4.5	-	-	0.9	-	0.9	-	0.9	
			5.5	-	-	1.1	-	1.1	-	1.1	
ALL OTHER PARTS											
V _{IH}	High- Level Input Voltage		2.0	1.5	-	-	1.5	-	1.5	-	V
			3.0	2.1	-	-	2.1	-	2.1	-	
			4.5	3.15	-	-	3.15	-	3.15	-	
			5.5	3.85	-	-	3.85	-	3.85	-	
V _{IL}	Low- Level Input Voltage		2.0	-	-	0.5	-	0.5	-	0.5	V
			3.0	-	-	0.9	-	0.9	-	0.9	
			4.5	-	-	1.35	-	1.35	-	1.35	
			5.5	-	-	1.65	-	1.65	-	1.65	
ALL PARTS											
V _{OH} (Note 5)	High- Level Output Voltage	V _{IN} = V _{IH} (V _{T+}) or V _{IL} (V _{T-}) I _{OH} = -50 μA	2.0	1.9	2.0	-	1.9	-	1.9	-	V
			3.0	2.9	3.0	-	2.9	-	2.9	-	
			4.5	4.4	4.5	-	4.4	-	4.4	-	
		V _{IN} = V _{IH} (V _{T+}) or V _{IL} (V _{T-}) I _{OH} = -4 mA	3.0	2.58	-	-	2.48	-	2.34	-	
			4.5	3.94	-	-	3.8	-	3.66	-	
			I _{OH} = -8 mA								

NLV18VHC1Gxx, NLV18VHC1GTxx

Table 3. DC ELECTRICAL CHARACTERISTICS (NLV18VHC1Gxx)

Symbol	Parameter	Conditions	V _{CC} (V)	T _A = 25°C			T _A = -40°C to 85°C		T _A = -55°C to +125°C		Unit
				Min	Typ	Max	Min	Max	Min	Max	
ALL PARTS											
V _{OL}	Low-Level Output Voltage	V _{IN} = V _{IH} (V _{T+}) or V _{IL} (V _{T-}) I _{OL} = 50 μA	2.0	-	0.0	0.1	-	0.1	-	0.1	V
			3.0	-	0.0	0.1	-	0.1	-	0.1	
			4.5	-	0.0	0.1	-	0.1	-	0.1	
		V _{IN} = V _{IH} (V _{T+}) or V _{IL} (V _{T-}) I _{OL} = 4 mA I _{OL} = 8 mA	3.0	-	-	0.36	-	0.44	-	0.52	
			4.5	-	-	0.36	-	0.44	-	0.52	
			4.5	-	-	0.36	-	0.44	-	0.52	
I _{IN}	Input Leakage Current	V _{IN} = 5.5 V or GND	5.5	-	-	±0.1	-	±1.0	-	±1.0	μA
I _{CC}	Quiescent Supply Current	V _{IN} = V _{CC} or GND	5.5	-	-	1.0	-	20	-	40	μA

Product parametric performance is indicated in the Electrical Characteristics for the listed test conditions, unless otherwise noted. Product performance may not be indicated by the Electrical Characteristics if operated under different conditions.

5. The V_{OH} parameter does not apply to devices with open-drain output, NLV18VHC1G05, NLV18VHC1G07, NLV18VHC1GT05 and NLV18VHC1GT07.

Table 4. DC ELECTRICAL CHARACTERISTICS (NLV18VHC1GTxx)

Symbol	Parameter	Conditions	V _{CC} (V)	T _A = 25°C			T _A = -40°C to 85°C		T _A = -55°C to +125°C		Unit
				Min	Typ	Max	Min	Max	Min	Max	
NLV18VHC1GT14 and NLV18VHC1GT17											
V _{T+}	Positive-Going Threshold		4.5	-	1.74	2.0	-	2.0	-	2.0	V
			5.5	-	1.94	2.1	-	2.1	-	2.1	
V _{T-}	Negative-Going Threshold		4.5	0.5	1.01	-	0.5	-	0.5	-	V
			5.5	0.6	1.13	-	0.6	-	0.6	-	
V _H	Hysteresis Voltage		4.5	0.4	0.73	1.4	0.4	1.4	0.4	1.4	V
			5.5	0.5	0.81	1.6	0.5	1.6	0.5	1.6	
ALL OTHER PARTS											
V _{IH}	High-Level Input Voltage		4.5 – 5.5	2.0	-	-	2.0	-	2.0	-	V
V _{IL}	Low-Level Input Voltage		4.5 – 5.5	-	-	0.8	-	0.8	-	0.8	V

ALL PARTS

V _{OH} (Note 4)	High-Level Output Voltage	V _{IN} = V _{IH} (V _{T+}) or V _{IL} (V _{T-}) I _{OH} = -50 μA I _{OH} = -8 mA									V
			4.5	4.4	4.5	-	4.4	-	4.4	-	
			4.5	3.94	-	-	3.80	-	3.66	-	
V _{OL}	Low-Level Output Voltage	V _{IN} = V _{IH} (V _{T+}) or V _{IL} (V _{T-}) I _{OL} = 50 μA I _{OL} = 8 mA									V
			4.5	-	0.0	0.1	-	0.1	-	0.1	
			4.5	-	-	0.36	-	0.44	-	0.52	
I _{IN}	Input Leakage Current	V _{IN} = V _{CC} or GND	5.5	-	-	±0.1	-	±1.0	-	±1.0	μA
I _{CC}	Quiescent Supply Current	V _{IN} = V _{CC} or GND; I _O = 0 A	5.5	-	-	1.0	-	20	-	40	μA
ΔI _{CC}	Additional Supply Current per Input	V _{IN} = 3.4 V; I _O = 0 A; Other input at V _{CC} or GND	5.5	-	-	1.35	-	1.5	-	1.65	mA

NLV18VHC1Gxx, NLV18VHC1GTxx

Table 5. AC ELECTRICAL CHARACTERISTICS (Input $t_r = t_f = 3.0$ ns)

Symbol	Parameter	Conditions	V _{CC} (V)	T _A = 25°C			-40°C ≤ T _A ≤ 85°C		-55°C ≤ T _A ≤ 125°C		Unit
				Min	Typ	Max	Min	Max	Min	Max	
t _{PLH} , t _{PHL}	Propagation Delay, A to Y (Figures 1 and 2)	C _L = 15 pF	3.0 to 3.6	-	7.0	12.8	-	15.0	-	17.0	ns
		C _L = 50 pF		-	8.5	16.3	-	18.5	-	20.5	
		C _L = 15 pF	4.5 to 5.5	-	4.0	8.6	-	10.0	-	11.5	
		C _L = 50 pF		-	5.5	10.6	-	12.0	-	13.5	
t _{PZL} , t _{PZH}	Output Enable Time, (A or \overline{OE} or OE) to Y (Figures 1 and 2)	C _L = 15 pF	3.0 to 3.6	-	4.5	8.0	-	9.5	-	11.5	ns
		C _L = 50 pF		-	6.4	11.5	-	13.0	-	15.0	
		C _L = 15 pF	4.5 to 5.5	-	3.5	5.1	-	6.0	-	8.5	
		C _L = 50 pF		-	4.5	7.1	-	8.0	-	10.5	
t _{PLZ} , t _{PHZ}	Output Disable Time, (A or \overline{OE} or OE) to Y (Figures 1 and 2)	C _L = 15 pF	3.0 to 3.6	-	6.5	9.7	-	11.5	-	14.5	ns
		C _L = 50 pF		-	8.0	13.2	-	15.0	-	18.0	
		C _L = 15 pF	4.5 to 5.5	-	4.8	6.8	-	8.0	-	10.0	
		C _L = 50 pF		-	7.0	8.8	-	10.0	-	12.0	
C _{IN}	Input Capacitance			-	4.0	10	-	10	-	10	pF
C _{OUT}	Output Capacitance	Output in High Impedance State		-	6.0	-	-	-	-	-	pF

C _{PD}	Power Dissipation Capacitance (Note 6)	Typical @ 25°C, V_{CC} = 5.0 V	pF
		8.0	

6. C_{PD} is defined as the value of the internal equivalent capacitance which is calculated from the operating current consumption without load. Average operating current can be obtained by the equation: $I_{CC(OPR)} = C_{PD} \cdot V_{CC} \cdot f_{in} + I_{CC}$. C_{PD} is used to determine the no-load dynamic power consumption; $P_D = C_{PD} \cdot V_{CC}^2 \cdot f_{in} + I_{CC} \cdot V_{CC}$.

NLV18VHC1Gxx, NLV18VHC1GTxx

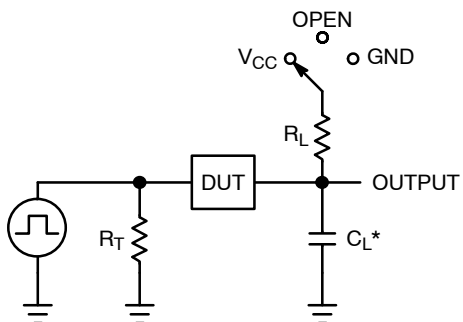

C_L includes probe and jig capacitance
 R_T is Z_{OUT} of pulse generator (typically 50 Ω)
 $f = 1$ MHz

Figure 1. Test Circuit

Test	Switch Position	C_L , pF	R_L , Ω
t_{PLH} / t_{PHL}	Open	See AC Characteristics Table	X
t_{PLZ} / t_{PZL}	V_{CC}		1 k
t_{PHZ} / t_{PZH}	GND		1 k

X = Don't Care

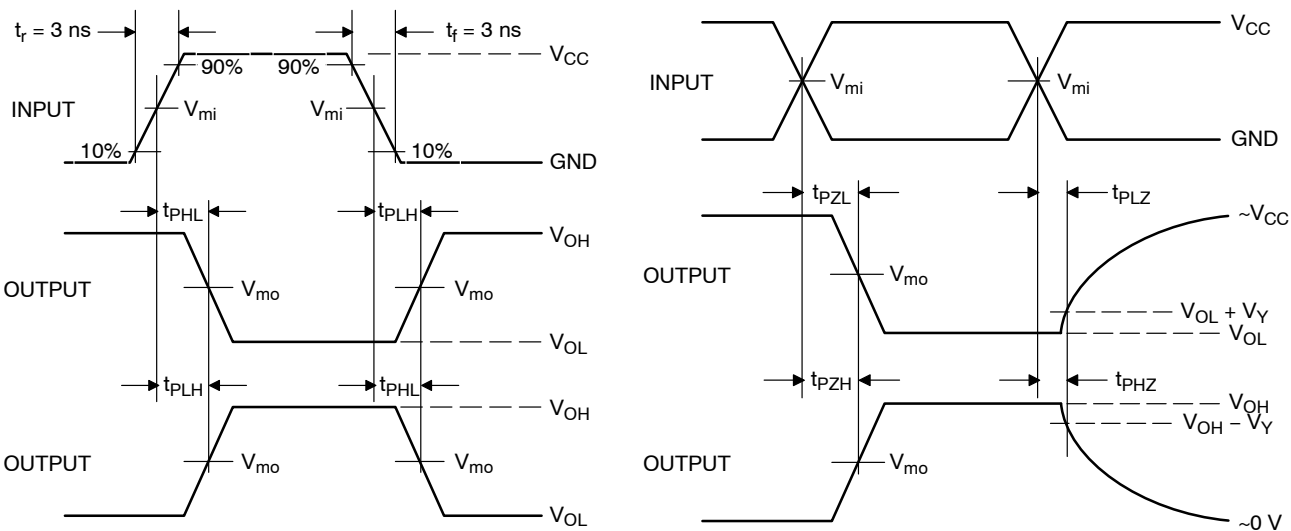

Figure 2. Switching Waveforms

V_{CC} , V	V_{mi} , V	V_{mo} , V		V_Y , V
		t_{PLH} , t_{PHL}	t_{PZL} , t_{PLZ} , t_{PZH} , t_{PHZ}	
3.0 to 3.6	$V_{CC}/2$	$(V_{OH} - V_{OL})/2$	$V_{CC}/2$	0.3
4.5 to 5.5	$V_{CC}/2$	$(V_{OH} - V_{OL})/2$	$V_{CC}/2$	0.3

NLV18VHC1Gxx, NLV18VHC1GTxx

ORDERING INFORMATION

Device	Package	Marking	Pin 1 Orientation (See below)	Shipping†
NLV18VHC1G00DFT2G	SC-88A	V1	Q4	3000 / Tape & Reel
NLV18VHC1G02DFT2G	SC-88A	V3	Q4	3000 / Tape & Reel
NLV18VHC1G04DFT2G	SC-88A	V5	Q4	3000 / Tape & Reel
NLV18VHC1G05DFT2G (in development)	SC-88A	VF	Q4	3000 / Tape & Reel
NLV18VHC1G07DFT2G (in development)	SC-88A	V7	Q4	3000 / Tape & Reel
NLV18VHC1G08DFT2G	SC-88A	V2	Q4	3000 / Tape & Reel
NLV18VHC1G09DFT2G	SC-88A	VX	Q4	3000 / Tape & Reel
NLV18VHC1G14DFT2G	SC-88A	VA	Q4	3000 / Tape & Reel
NLV18VHC1G17DFT2G (in development)	SC-88A	TBD	Q4	3000 / Tape & Reel
NLV18VHC1G32DFT2G	SC-88A	V4	Q4	3000 / Tape & Reel
NLV18VHC1G32DFT1G	SC-88A	V4	Q2	3000 / Tape & Reel
NLV18VHC1G50DFT2G (in development)	SC-88A	VR	Q4	3000 / Tape & Reel
NLV18VHC1G86DFT2G (in development)	SC-88A	V8	Q4	3000 / Tape & Reel
NLV18VHC1G125DFT2G	SC-88A	W0	Q4	3000 / Tape & Reel
NLV18VHC1G126DFT2G (in development)	SC-88A	W2	Q4	3000 / Tape & Reel
NLV18VHC1G132DFT2G	SC-88A	VD	Q4	3000 / Tape & Reel
NLV18VHC1GU04DFT2G (in development)	SC-88A	V6	Q4	3000 / Tape & Reel
NLV18VHC1GT00DFT2G (in development)	SC-88A	VH	Q4	3000 / Tape & Reel
NLV18VHC1GT02DFT2G (in development)	SC-88A	VJ	Q4	3000 / Tape & Reel
NLV18VHC1GT04DFT2G	SC-88A	VK	Q4	3000 / Tape & Reel
NLV18VHC1GT05DFT2G (in development)	SC-88A	TBD	Q4	3000 / Tape & Reel
NLV18VHC1GT07DFT2G (in development)	SC-88A	TBD	Q4	3000 / Tape & Reel
NLV18VHC1GT08DFT2G	SC-88A	VT	Q4	3000 / Tape & Reel
NLV18VHC1GT14DFT2G (in development)	SC-88A	VC	Q4	3000 / Tape & Reel
NLV18VHC1GT17DFT2G (in development)	SC-88A	TBD	Q4	3000 / Tape & Reel
NLV18VHC1GT32DFT2G (in development)	SC-88A	VN	Q4	3000 / Tape & Reel
NLV18VHC1GT50DFT2G (in development)	SC-88A	VL	Q4	3000 / Tape & Reel
NLV18VHC1GT86DFT2G (in development)	SC-88A	VM	Q4	3000 / Tape & Reel
NLV18VHC1GT125DFT2G	SC-88A	W1	Q4	3000 / Tape & Reel
NLV18VHC1GT126DFT2G (in development)	SC-88A	W3	Q4	3000 / Tape & Reel

†For information on tape and reel specifications, including part orientation and tape sizes, please refer to our Tape and Reel Packaging Specifications Brochure, BRD8011/D.

*NLV Prefix for Automotive and Other Applications Requiring Unique Site and Control Change Requirements; AEC-Q100 Qualified and PPAP Capable.

Pin 1 Orientation in Tape and Reel

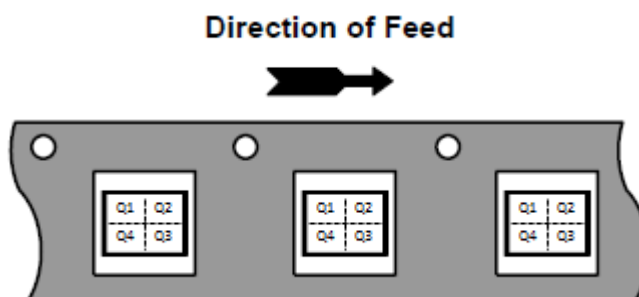

NLV18VHC1Gxx, NLV18VHC1GTxx

PACKAGE DIMENSIONS

SC-88A (SC-70-5/SOT-353)
CASE 419A-02
ISSUE L

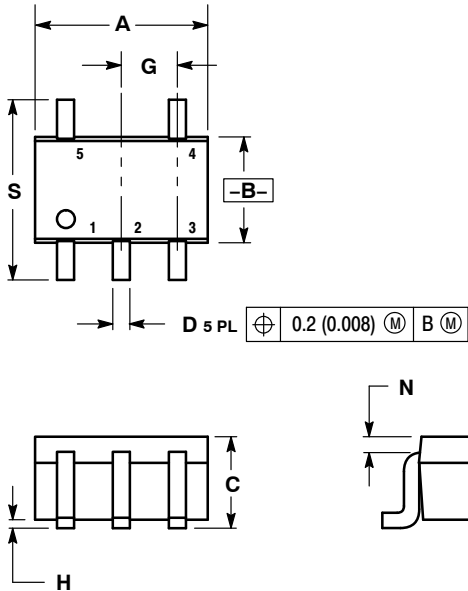

NOTES:

1. DIMENSIONING AND TOLERANCING PER ANSI Y14.5M, 1982.
2. CONTROLLING DIMENSION: INCH.
3. 419A-01 OBSOLETE. NEW STANDARD 419A-02.
4. DIMENSIONS A AND B DO NOT INCLUDE MOLD FLASH, PROTRUSIONS, OR GATE BURRS.

DIM	INCHES		MILLIMETERS	
	MIN	MAX	MIN	MAX
A	0.071	0.087	1.80	2.20
B	0.045	0.053	1.15	1.35
C	0.031	0.043	0.80	1.10
D	0.004	0.012	0.10	0.30
G	0.026 BSC		0.65 BSC	
H	---	0.004	---	0.10
J	0.004	0.010	0.10	0.25
K	0.004	0.012	0.10	0.30
N	0.008 REF		0.20 REF	
S	0.079	0.087	2.00	2.20

SOLDER FOOTPRINT*

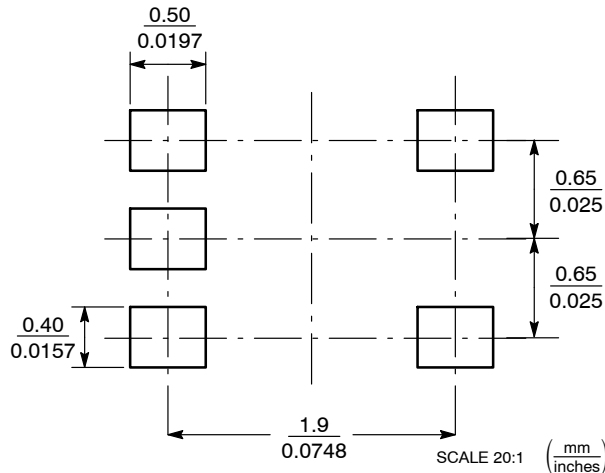

*For additional information on our Pb-Free strategy and soldering details, please download the ON Semiconductor Soldering and Mounting Techniques Reference Manual, SOLDERRM/D.

ON Semiconductor and are trademarks of Semiconductor Components Industries, LLC dba ON Semiconductor or its subsidiaries in the United States and/or other countries. ON Semiconductor owns the rights to a number of patents, trademarks, copyrights, trade secrets, and other intellectual property. A listing of ON Semiconductor's product/patent coverage may be accessed at www.onsemi.com/site/pdf/Patent-Marketing.pdf. ON Semiconductor reserves the right to make changes without further notice to any products herein. ON Semiconductor makes no warranty, representation or guarantee regarding the suitability of its products for any particular purpose, nor does ON Semiconductor assume any liability arising out of the application or use of any product or circuit, and specifically disclaims any and all liability, including without limitation special, consequential or incidental damages. Buyer is responsible for its products and applications using ON Semiconductor products, including compliance with all laws, regulations and safety requirements or standards, regardless of any support or applications information provided by ON Semiconductor. "Typical" parameters which may be provided in ON Semiconductor data sheets and/or specifications can and do vary in different applications and actual performance may vary over time. All operating parameters, including "Typicals" must be validated for each customer application by customer's technical experts. ON Semiconductor does not convey any license under its patent rights nor the rights of others. ON Semiconductor products are not designed, intended, or authorized for use as a critical component in life support systems or any FDA Class 3 medical devices or medical devices with a same or similar classification in a foreign jurisdiction or any devices intended for implantation in the human body. Should Buyer purchase or use ON Semiconductor products for any such unintended or unauthorized application, Buyer shall indemnify and hold ON Semiconductor and its officers, employees, subsidiaries, affiliates, and distributors harmless against all claims, costs, damages, and expenses, and reasonable attorney fees arising out of, directly or indirectly, any claim of personal injury or death associated with such unintended or unauthorized use, even if such claim alleges that ON Semiconductor was negligent regarding the design or manufacture of the part. ON Semiconductor is an Equal Opportunity/Affirmative Action Employer. This literature is subject to all applicable copyright laws and is not for resale in any manner.

PUBLICATION ORDERING INFORMATION

LITERATURE FULFILLMENT:
Email Requests to: orderlit@onsemi.com

TECHNICAL SUPPORT
North American Technical Support:
Voice Mail: 1 800-282-9855 Toll Free USA/Canada
Phone: 011 421 33 790 2910

Europe, Middle East and Africa Technical Support:
Phone: 00421 33 790 2910
For additional information, please contact your local Sales Representative