

# Voltage Regulator - Low Iq, Low Dropout, Power Good Output

## 1.2 A

## NCV8187

The NCV8187 is 1.2 A LDO Linear Voltage Regulator. It is a very stable and accurate device with low quiescent current consumption (typ. 30  $\mu$ A over the full temperature range), low dropout, low output noise and very good PSRR. The regulator incorporates several protection features such as Thermal Shutdown, Soft Start, Current Limiting and also Power Good Output signal for easy MCU interfacing.

### Features

- Operating Input Voltage Range: 1.5 V to 5.5 V
- Adjustable and Fixed Voltage Options Available: 0.8 V to 5.2 V
- Low Quiescent Current: typ. 30  $\mu$ A over Temperature
- $\pm 2\%$  Accuracy Over Full Load, Line and Temperature variations
- PSRR: 75 dB at 1 kHz
- Low Noise: typ. 15  $\mu$ V<sub>RMS</sub> from 10 Hz to 100 kHz
- Stable With Small 10  $\mu$ F Ceramic Capacitor
- Soft-start to Reduce Inrush Current and Overshoots
- Thermal Shutdown and Current Limit Protection
- Power Good Signal Extends Application Range
- Available in WDFN6 and WDFNW6 2x2, DFN6 3x3, DFNW6 3x3, DFNW8 3x3 and DPAK-5 with Wettable Flank (pin edge plating)
- NCV Prefix for Automotive and Other Applications Requiring Unique Site and Control Change Requirements; AEC-Q100 Qualified and PPAP Capable
- These Devices are Pb-Free, Halogen Free/BFR Free and are RoHS Compliant

### Typical Applications

- Wireless Chargers and Portable Equipment
- Smart Camera and Robotic Vision Systems
- Telecommunication and Networking Systems
- Infotainment and Cluster
- Modular Platforms for Dashboard Display
- Internet Connection Sharing (ICS) Gateway Server Applications
- General Purpose Automotive

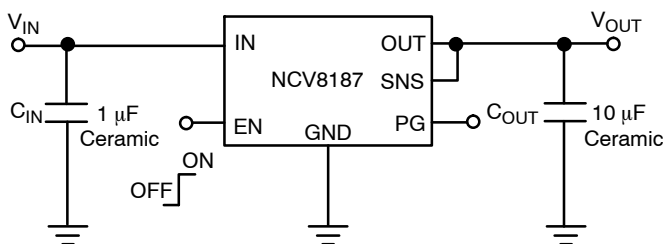

Figure 1. Typical Application Schematic



ON Semiconductor®

[www.onsemi.com](http://www.onsemi.com)

### GENERIC MARKING DIAGRAMS

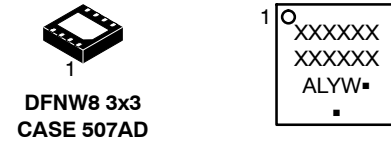

XXXXXX = Specific Device Code  
A = Assembly Location  
L = Wafer Lot  
Y = Year  
W/WW = Work Week  
D = Date Code  
#/G = Pb-Free Package

(Note: Microdot may be in either location)

### ORDERING INFORMATION

See detailed ordering and shipping information in the package dimensions section on page 10 of this data sheet.

# NCV8187

## PIN FUNCTION CONNECTION

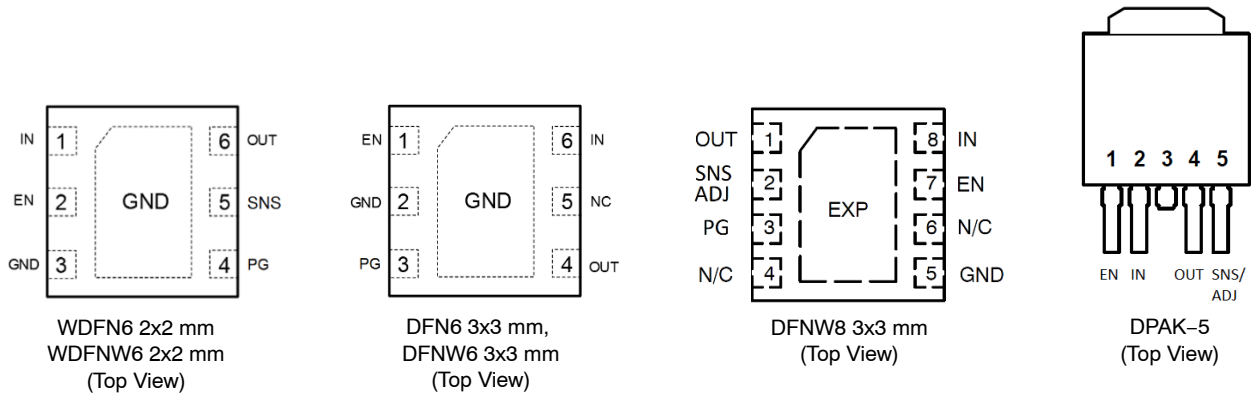

Figure 2. Pin Function Connection

### PIN FUNCTION DESCRIPTION

Pin No. WDFN6 & WDFNW6 2x2	Pin No. DFN6 & DFNW6 3x3	Pin No. DFNW8 3x3	Pin No. DPAK-5	Pin Name	Description
1	6	8	2	IN	Input pin. A small capacitor is needed from this pin to ground to assure stability
6	4	1	4	OUT	Regulated output voltage pin. A small 10 $\mu$ F ceramic capacitor is needed from this pin to ground to assure stability
3, EXP	2, EXP	5, EXP	TAB	GND	Power supply ground
2	1	7	1	EN	Enable pin. Driving this pin high turns on the regulator. Driving EN pin low puts the regulator into shutdown mode
5	-	2 / -	5 / -	SNS	Sense pin. Connect this pin to regulated output voltage
-	-	- / 2	- / 5	ADJ	Adjustable feedback voltage input. Connect this pin to external resistor divider for desired voltage output
4	3	3	-	PG	Power Good, open collector. Use 10 k $\Omega$ to 100 k $\Omega$ pull-up resistor connected to output or input voltage
-	5	4, 6	-	NC	No connection. This pin can be tied to ground to improve thermal dissipation or left disconnected

**ABSOLUTE MAXIMUM RATINGS**

Ratings	Symbol	Value	Unit
Input Voltage (Note 1)	$V_{IN}$	-0.3 to 6	V
Enable Voltage	$V_{EN}$	-0.3 to 6	V
Power Good Current	$I_{PG}$	30	mA
Power Good Voltage	$V_{PG}$	-0.3 to 6	V
Output Voltage	$V_{OUT}$	-0.3 to $V_{IN} + 0.3$ (max. 5.5)	V
Output Short Circuit Duration	$t_{SC}$	Indefinite	s
Maximum Junction Temperature	$T_{J(MAX)}$	150	°C
Storage Temperature	$T_{STG}$	-55 to 150	°C
ESD Capability, Human Body Model (Note 2)	$ESD_{HBM}$	2000	V
ESD Capability, Machine Model (Note 2)	$ESD_{MM}$	200	V

Stresses exceeding those listed in the Maximum Ratings table may damage the device. If any of these limits are exceeded, device functionality should not be assumed, damage may occur and reliability may be affected.

1. Refer to ELECTRICAL CHARACTERISTICS and APPLICATION INFORMATION for Safe Operating Area.

2. This device series incorporates ESD protection and is tested by the following methods:

ESD Human Body Model tested per AEC-Q100-002 (EIA/JESD22-A114)

ESD Machine Model tested per AEC-Q100-003 (EIA/JESD22-A115)

**THERMAL CHARACTERISTICS**

Rating	Symbol	Value	Unit
--------	--------	-------	------

**THERMAL CHARACTERISTICS, WDFN6, 2x2, 0.65 PITCH PACKAGE**

Thermal Resistance, Junction-to-Ambient (Note 3)	$R_{\theta JA}$	51	°C/W
Thermal Resistance, Junction-to-Case (top)	$R_{\theta JC(top)}$	142	°C/W
Thermal Resistance, Junction-to-Case (bottom) (Note 4)	$R_{\theta JC(bot)}$	7.8	°C/W
Thermal Resistance, Junction-to-Board	$R_{\theta JB}$	125	°C/W
Characterization Parameter, Junction-to-Top	$\Psi_{JT}$	2.0	°C/W
Characterization Parameter, Junction-to-Board	$\Psi_{JB}$	7.7	°C/W

**THERMAL CHARACTERISTICS, DFN6 / DFNW6, 3x3, 0.95 PITCH PACKAGES**

Thermal Resistance, Junction-to-Ambient (Note 3)	$R_{\theta JA}$	50	°C/W
Thermal Resistance, Junction-to-Case (top)	$R_{\theta JC(top)}$	142	°C/W
Thermal Resistance, Junction-to-Case (bottom) (Note 4)	$R_{\theta JC(bot)}$	7.9	°C/W
Thermal Resistance, Junction-to-Board	$R_{\theta JB}$	125	°C/W
Characterization Parameter, Junction-to-Top	$\Psi_{JT}$	2.0	°C/W
Characterization Parameter, Junction-to-Board	$\Psi_{JB}$	7.5	°C/W

3. The junction-to-ambient thermal resistance under natural convection is obtained in a simulation on a high-K board, following the JEDEC51.7 guidelines with assumptions as above, in an environment described in JESD51-2a.

4. The junction-to-case (bottom) thermal resistance is obtained by simulating a cold plate test on the IC exposed pad. Test description can be found in the ANSI SEMI standard G30-88.

# NCV8187

## ELECTRICAL CHARACTERISTICS – WDFN6 2x2, WDFNW6 2x2, DFN6 3x3 AND DFNW6 3x3 ( $-40^{\circ}\text{C} \leq T_J \leq 150^{\circ}\text{C}$ ;

$V_{IN} = V_{OUT} + 1.0\text{ V}$ ;  $I_{OUT} = 10\text{ mA}$ ,  $C_{IN} = 1\text{ }\mu\text{F}$ ,  $C_{OUT} = 10\text{ }\mu\text{F}$ , unless otherwise noted. Typical values are at  $T_J = +25^{\circ}\text{C}$ . (Note 6))

Parameter	Test Conditions		Symbol	Min	Typ	Max	Unit
Operating Input Voltage			$V_{IN}$	1.5	–	5.5	V
Output Voltage Accuracy	$-40^{\circ}\text{C} \leq T_J \leq 150^{\circ}\text{C}$ , $V_{OUT} + 1\text{ V} < V_{IN} < 5.5\text{ V}$ , $0\text{ mA} < I_{OUT} < 1.2\text{ A}$	$V_{OUT} < 1.7\text{ V}$	$V_{OUT}$	-35 mV	–	+35 mV	V
		$V_{OUT} \geq 1.7\text{ V}$		-2%	–	+2%	
Reference Voltage			$V_{REF}$	–	0.8	–	V
Line Regulation	$V_{OUT} + 1\text{ V} \leq V_{IN} \leq 5.5\text{ V}$ , $I_{OUT} = 1\text{ mA}$		$\text{Reg}_{LINE}$	–	40	–	$\mu\text{V/V}$
Load Regulation	$I_{OUT} = 0\text{ mA}$ to $1.2\text{ A}$		$\text{Reg}_{LOAD}$	–	2	–	$\mu\text{V/mA}$
Dropout Voltage	$V_{DO} = V_{IN} - (V_{OUT(NOM)} - 3\%)$ $I_{OUT} = 1.2\text{ A}$	1.2 V – 1.4 V	$V_{DO}$	–	325	495	mV
		1.5 V – 1.7 V		–	240	400	
		1.8 V – 2.7 V		–	200	335	
		2.8 V – 3.2 V		–	165	250	
		3.3 V – 4.9 V		–	150	220	
		5 V		–	120	180	
Maximum Output Current	(Note 7)		$I_{OUT}$	1300	1750	–	mA
Short Circuit Current	(Note 7)		$I_{SC}$	–	1850	–	mA
Disable Current	$V_{EN} = 0\text{ V}$		$I_{DIS}$	–	0.1	5.0	$\mu\text{A}$
Quiescent Current	$I_{OUT} = 0\text{ mA}$		$I_Q$	–	30	45	$\mu\text{A}$
Ground Current	$I_{OUT} = 1.2\text{ A}$		$I_{GND}$	–	2	–	mA
Power Supply Rejection Ratio	$V_{IN} = 3.5\text{ V} + 100\text{ mVpp}$ $V_{OUT} = 2.5\text{ V}$ $I_{OUT} = 10\text{ mA}$ , $C_{OUT} = 1\text{ }\mu\text{F}$	$f = 1\text{ kHz}$	PSRR	–	75	–	dB
Output Noise Voltage	$V_{OUT} = 1.8\text{ V}$ , $I_{OUT} = 10\text{ mA}$ , $f = 10\text{ Hz}$ to $100\text{ kHz}$		$V_N$	–	15	–	$\mu\text{V}_{rms}$
Enable Input Threshold Voltage	Voltage increasing		$V_{EN\_HI}$	0.9	–	–	V
	Voltage decreasing		$V_{EN\_LO}$	–	–	0.3	
EN Pin Current	$V_{EN} = 5.5\text{ V}$			–	100	–	nA
Active Output Discharge Resistance	$V_{IN} = 5.5\text{ V}$ , $V_{EN} = 0\text{ V}$		$R_{DIS}$	–	120	–	$\Omega$
Power Good, Output Voltage Raising			$V_{PGup}$	–	92	–	%
Power Good, Output Voltage Falling			$V_{PGdw}$	–	80	–	%
Power Good Output Voltage Low	$I_{PG} = 6\text{ mA}$ , Open drain		$V_{PGlo}$	–	0.14	0.4	V
Thermal Shutdown Temperature (Note 5)	Temperature increasing from $T_J = +25^{\circ}\text{C}$		$T_{SD}$	–	170	–	$^{\circ}\text{C}$
Thermal Shutdown Hysteresis (Note 5)	Temperature falling from TSD		$T_{SDH}$	–	15	–	$^{\circ}\text{C}$

Product parametric performance is indicated in the Electrical Characteristics for the listed test conditions, unless otherwise noted. Product performance may not be indicated by the Electrical Characteristics if operated under different conditions.

5. Guaranteed by design and characterization.

6. Performance guaranteed over the indicated operating temperature range by design and/or characterization production tested at  $T_J = T_A = 25^{\circ}\text{C}$ . Low duty cycle pulse techniques are used during testing to maintain the junction temperature as close to ambient as possible.

7. Respect SOA.

# NCV8187

**ELECTRICAL CHARACTERISTICS – DFNW8 3x3 AND DPAK-5** ( $-40^{\circ}\text{C} \leq T_J \leq 150^{\circ}\text{C}$ ;  $V_{\text{IN}} = V_{\text{OUT}} + 1.0 \text{ V}$ ;  $I_{\text{OUT}} = 10 \text{ mA}$ ,  $C_{\text{IN}} = 1 \mu\text{F}$ ,  $C_{\text{OUT}} = 10 \mu\text{F}$ , unless otherwise noted. Typical values are at  $T_J = +25^{\circ}\text{C}$ . (Note 9))

Parameter	Test Conditions	Symbol	Min	Typ	Max	Unit
Operating Input Voltage		$V_{\text{IN}}$	1.5	–	5.5	V
Output Voltage Accuracy	$-40^{\circ}\text{C} \leq T_J \leq 150^{\circ}\text{C}$ , $V_{\text{OUT}} + 1 \text{ V} < V_{\text{IN}} < 5.5 \text{ V}$ , $0 \text{ mA} < I_{\text{OUT}} < 1 \text{ A}$	$V_{\text{OUT}} < 1.7 \text{ V}$	-35 mV	–	+35 mV	V
		$V_{\text{OUT}} \geq 1.7 \text{ V}$	-2%	–	+2%	
Reference Voltage		$V_{\text{REF}}$	–	1.2	–	V
Line Regulation	$V_{\text{OUT}} + 1 \text{ V} \leq V_{\text{IN}} \leq 5.5 \text{ V}$ , $I_{\text{OUT}} = 1 \text{ mA}$	$\text{Reg}_{\text{LINE}}$	–	40	–	$\mu\text{V}/\text{V}$
Load Regulation	$I_{\text{OUT}} = 0 \text{ mA}$ to $1 \text{ A}$	$\text{Reg}_{\text{LOAD}}$	–	2	–	$\mu\text{V}/\text{mA}$
Dropout Voltage	$V_{\text{DO}} = V_{\text{IN}} - (V_{\text{OUT(NOM)}} - 3\%)$ $I_{\text{OUT}} = 1 \text{ A}$	1.2 V – 1.4 V	–	295	450	mV
		1.5 V – 1.7 V	–	220	360	
		1.8 V – 2.7 V	–	180	305	
		2.8 V – 3.2 V	–	150	225	
		3.3 V – 4.9 V	–	135	200	
		5 V	–	110	165	
Maximum Output Current	(Note 10), $T_J = 25^{\circ}\text{C}$	$I_{\text{OUT}}$	1025	1500	1750	mA
Maximum Output Current	(Note 10)	$I_{\text{OUT}}$	1025	1500	1950	mA
Short Circuit Current	(Note 10)	$I_{\text{SC}}$	–	1550	–	mA
Disable Current	$V_{\text{EN}} = 0 \text{ V}$	$I_{\text{DIS}}$	–	0.1	5.0	$\mu\text{A}$
Quiescent Current	$I_{\text{OUT}} = 0 \text{ mA}$	$I_{\text{Q}}$	–	30	45	$\mu\text{A}$
Ground Current	$I_{\text{OUT}} = 1 \text{ A}$	$I_{\text{GND}}$	–	2	–	mA
Power Supply Rejection Ratio	$V_{\text{IN}} = 3.5 \text{ V} + 100 \text{ mVpp}$ $V_{\text{OUT}} = 2.5 \text{ V}$ $I_{\text{OUT}} = 10 \text{ mA}$ , $C_{\text{OUT}} = 1 \mu\text{F}$	$f = 1 \text{ kHz}$ $\text{PSRR}$	–	75	–	dB
Output Noise Voltage	$V_{\text{OUT}} = 1.8 \text{ V}$ , $I_{\text{OUT}} = 10 \text{ mA}$ , $f = 10 \text{ Hz}$ to $100 \text{ kHz}$	$V_{\text{N}}$	–	15	–	$\mu\text{V}_{\text{rms}}$
Enable Input Threshold Voltage	Voltage increasing	$V_{\text{EN\_HI}}$	0.9	–	–	V
	Voltage decreasing	$V_{\text{EN\_LO}}$	–	–	0.3	
EN Pin Current	$V_{\text{EN}} = 5.5 \text{ V}$		–	100	–	nA
Active Output Discharge Resistance	$V_{\text{IN}} = 5.5 \text{ V}$ , $V_{\text{EN}} = 0 \text{ V}$	$R_{\text{DIS}}$	–	120	–	$\Omega$
Power Good, Output Voltage Raising		$V_{\text{PGup}}$	–	92	–	%
Power Good, Output Voltage Falling		$V_{\text{PGdw}}$	–	80	–	%
Power Good Output Voltage Low	$I_{\text{PG}} = 6 \text{ mA}$ , Open drain	$V_{\text{PGlo}}$	–	0.14	0.4	V
Thermal Shutdown Temperature (Note 8)	Temperature increasing from $T_J = +25^{\circ}\text{C}$	$T_{\text{SD}}$	–	170	–	$^{\circ}\text{C}$
Thermal Shutdown Hysteresis (Note 8)	Temperature falling from TSD	$T_{\text{SDH}}$	–	15	–	$^{\circ}\text{C}$

Product parametric performance is indicated in the Electrical Characteristics for the listed test conditions, unless otherwise noted. Product performance may not be indicated by the Electrical Characteristics if operated under different conditions.

8. Guaranteed by design and characterization.

9. Performance guaranteed over the indicated operating temperature range by design and/or characterization production tested at  $T_J = T_A = 25^{\circ}\text{C}$ . Low duty cycle pulse techniques are used during testing to maintain the junction temperature as close to ambient as possible.

10. Respect SOA.

TYPICAL CHARACTERISTICS

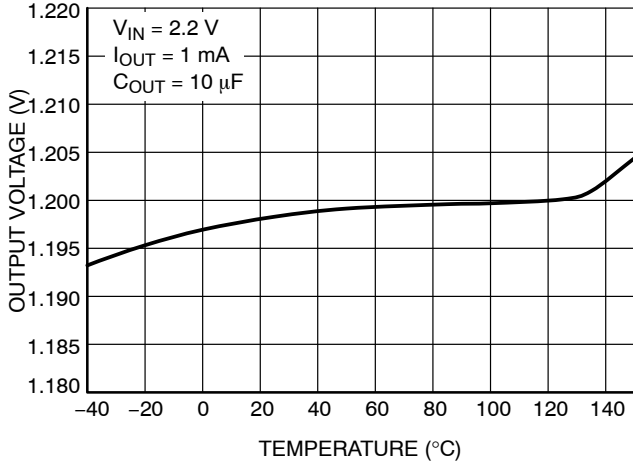

Figure 3. Output Voltage vs. Temperature –  $V_{OUT} = 1.2\text{ V}$

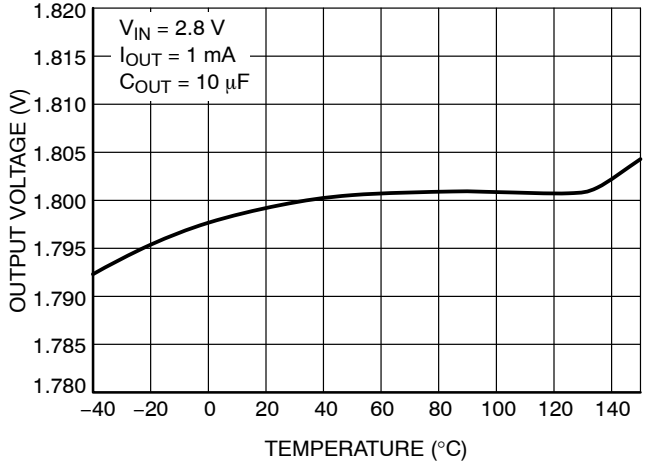

Figure 4. Output Voltage vs. Temperature –  $V_{OUT} = 1.8\text{ V}$

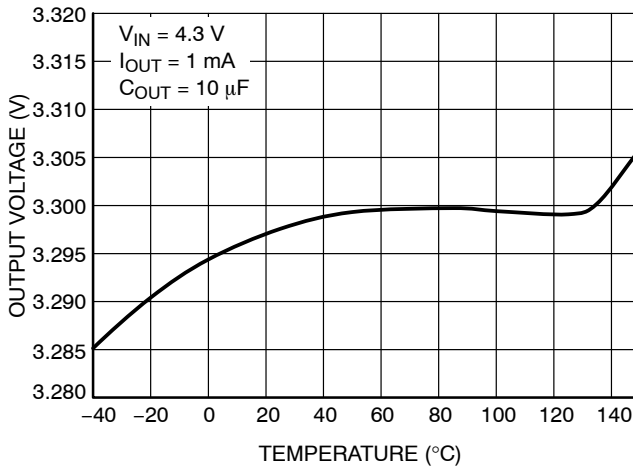

Figure 5. Output Voltage vs. Temperature –  $V_{OUT} = 3.3\text{ V}$

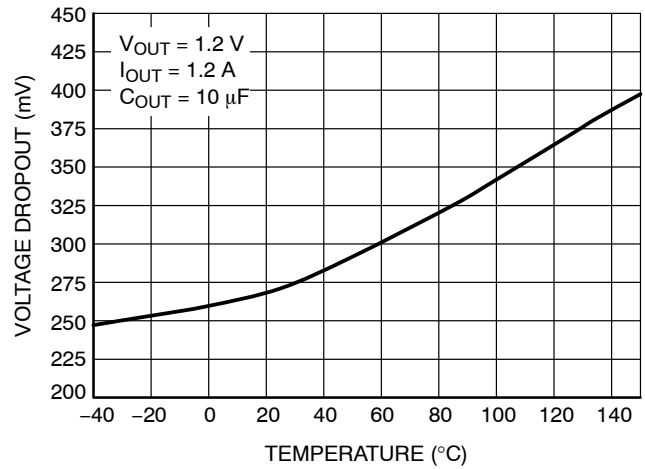

Figure 6. Dropout Voltage vs. Temperature –  $V_{OUT} = 1.2\text{ V}$

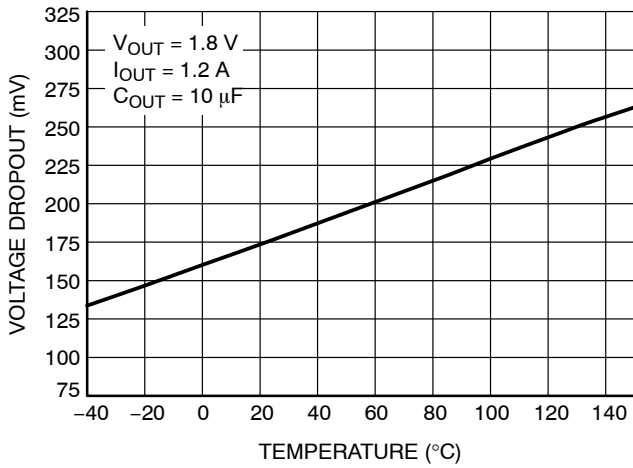

Figure 7. Dropout Voltage vs. Temperature –  $V_{OUT} = 1.8\text{ V}$

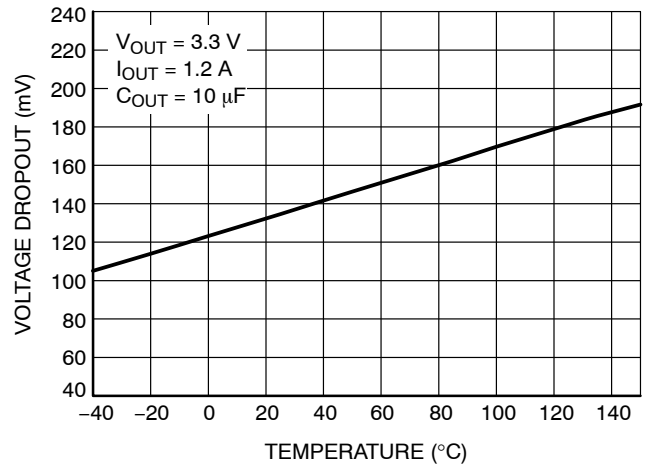

Figure 8. Dropout Voltage vs. Temperature –  $V_{OUT} = 3.3\text{ V}$

TYPICAL CHARACTERISTICS

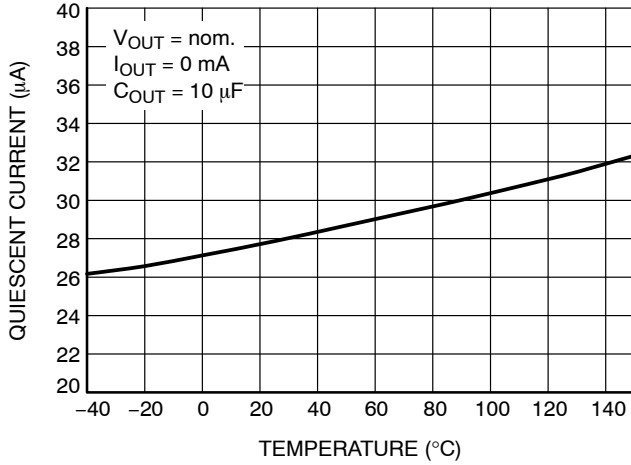

Figure 9. Quiescent Current vs. Temperature

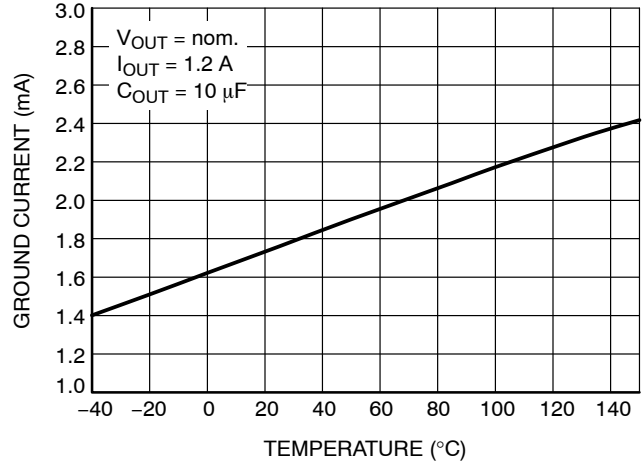

Figure 10. Ground Current vs. Temperature

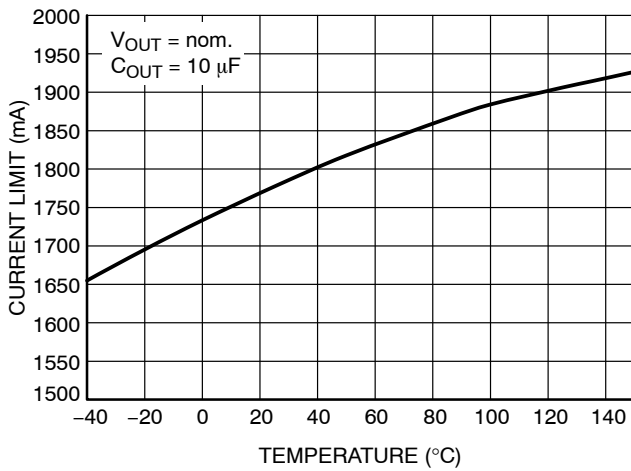

Figure 11. Current Limit vs. Temperature

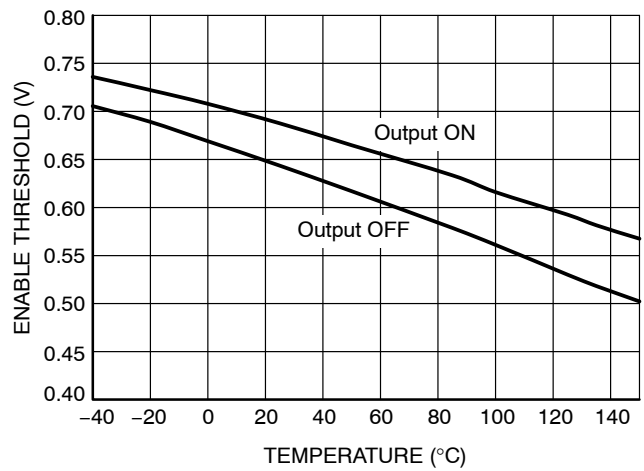

Figure 12. Enable Thresholds vs. Temperature

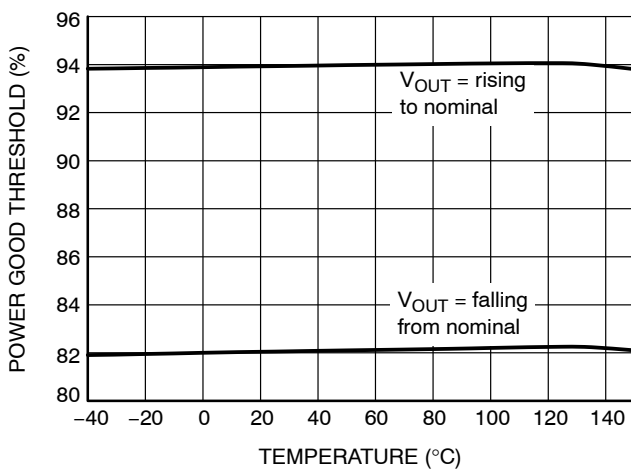

Figure 13. Power Good Thresholds vs. Temperature

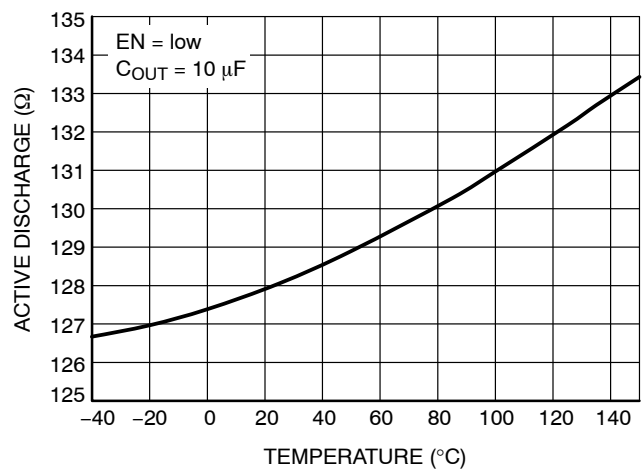

Figure 14. Active Discharge Resistance vs. Temperature

TYPICAL CHARACTERISTICS

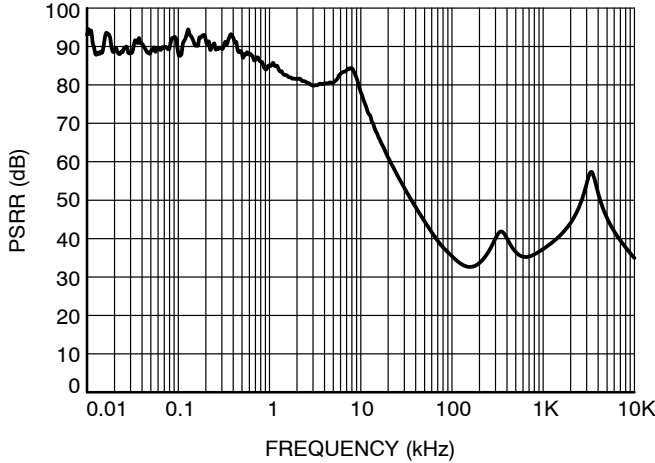

Figure 15. Power Supply Rejection Ratio for  $V_{OUT} = 1.8\text{ V}$ ,  $I_{OUT} = 10\text{ mA}$ ,  $C_{OUT} = 10\text{ }\mu\text{F}$

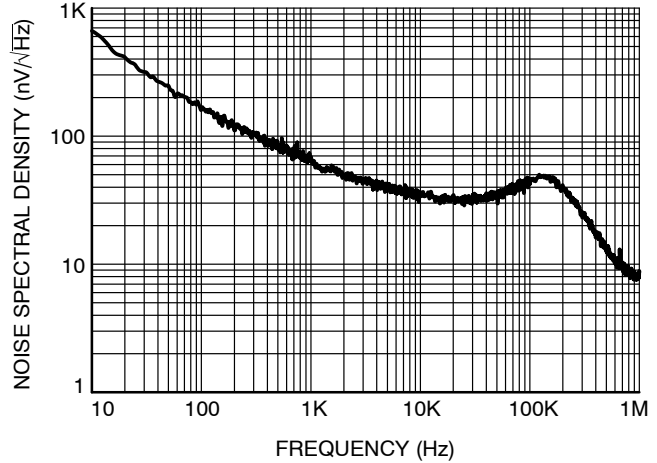

Figure 16. Output Voltage Noise Spectral Density for  $V_{OUT} = 1.8\text{ V}$ ,  $I_{OUT} = 10\text{ mA}$ ,  $C_{OUT} = 10\text{ }\mu\text{F}$

APPLICATIONS INFORMATION

The NCV8187 is the member of new family of high output current and low dropout regulators which delivers low quiescent and ground current consumption, good noise and power supply ripple rejection ratio performance. The NCV8187 incorporates EN pin and power good output for simple controlling by MCU or logic. Standard features include current limiting, soft-start feature and thermal protection.

**Input Decoupling (C<sub>IN</sub>)**

It is recommended to connect at least 1  $\mu\text{F}$  ceramic X5R or X7R capacitor between IN and GND pin of the device. This capacitor will provide a low impedance path for any unwanted AC signals or noise superimposed onto constant input voltage. The good input capacitor will limit the influence of input trace inductances and source resistance during sudden load current changes. Higher capacitance and lower ESR capacitors will improve the overall line transient response.

**Output Decoupling (C<sub>OUT</sub>)**

The NCV8187 does not require a minimum Equivalent Series Resistance (ESR) for the output capacitor. The device is designed to be stable with standard ceramics capacitors with values of 4.7  $\mu\text{F}$  or greater. Recommended capacitor for the best performance is 10  $\mu\text{F}$ . The X5R and X7R types have the lowest capacitance variations over temperature thus they are recommended.

**Power Good Output Connection**

The NCV8187 include Power Good functionality for better interfacing to MCU system. Power Good output is open collector type, capable to sink up to 10 mA.

Recommended operating current is between 10  $\mu\text{A}$  and 1 mA to obtain low saturation voltage. External pull-up resistor can be connected to any voltage up to 5.5 V (please see Absolute Maximum Ratings table above).

**Power Dissipation and Heat Sinking**

The maximum power dissipation supported by the device is dependent upon board design and layout. Mounting pad configuration on the PCB, the board material, and the ambient temperature affect the rate of junction temperature rise for the part. For reliable operation junction temperature should be limited to +125°C. The maximum power dissipation the NCV8187 can handle is given by:

$$P_{D(MAX)} = \frac{[T_{J(MAX)} - T_A]}{R_{\theta JA}} \quad (\text{eq. 1})$$

The power dissipated by the NCV8187 for given application conditions can be calculated from the following equations:

$$P_D \approx V_{IN}(I_{GND} + I_{OUT}) + I_{OUT}(V_{IN} - V_{OUT}) \quad (\text{eq. 2})$$

or

$$V_{IN(MAX)} \approx \frac{P_{D(MAX)} + (V_{OUT} \times I_{OUT})}{I_{OUT} + I_{GND}} \quad (\text{eq. 3})$$

**Hints**

$V_{IN}$  and GND printed circuit board traces should be as wide as possible. When the impedance of these traces is high, there is a chance to pick up noise or cause the regulator to malfunction. Place external components, especially the output capacitor, as close as possible to the NCV8187, and make traces as short as possible.



ADJUSTABLE VERSION

Not only adjustable version, but also any fixed version can be used to create adjustable voltage, where original fixed voltage becomes reference voltage for resistor divider and feedback loop. Output voltage can be equal or higher than original fixed option, while possible range is from 0.8 V up to 5.2 V. Picture below shows how to add external resistors to increase output voltage above fixed value.

Output voltage is then given by equation:

$$V_{OUT} = V_{FIX} \times (1 + R1/R2)$$

where  $V_{FIX}$  is voltage of original fixed version (from 0.8 V up to 5.2 V). Do not operate the device at output voltage about 5.2 V, as device can be damaged.

In order to avoid influence of current flowing into SNS pin to output voltage accuracy (SNS current varies with voltage option and temperature, typical value is 300 nA) it is recommended to use values of R1 and R2 below 500 kΩ.

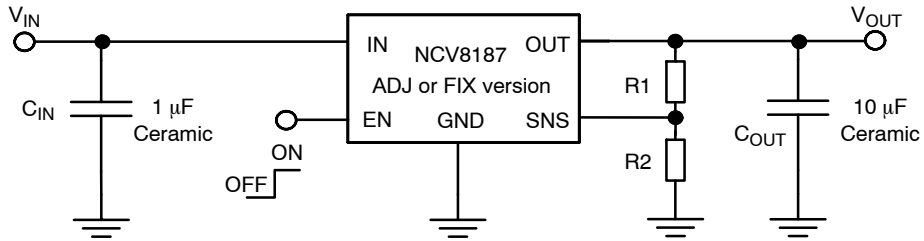

Figure 17.

Please note that output noise is amplified by  $V_{OUT} / V_{FIX}$  ratio. For example, if original 0.8 V fixed variant is used to create 3.6 V output voltage, output noise is increased  $3.6/0.8 = 4.5$  times and real value will be  $4.5 \times 15 \mu V_{rms} = 67.5 \mu V_{rms}$ . For noise sensitive applications it is

recommended to use as high fixed variant as possible – for example in case above it is better to use 3.3 V fixed variant to create 3.6 V output voltage, as output noise will be amplified only  $3.6/3.3 = 1.09 \times (16.4 \mu V_{rms})$ .

# NCV8187

## ORDERING INFORMATION

Device Part No.	Voltage Option	Marking	Option	Package	Shipping <sup>†</sup>
NCV8187AMT110TAG	1.1 V	PM	With Active Output Discharge	WDFN6 2x2 non WF (Pb-Free)	3,000 / Tape & Reel
NCV8187AMT120TAG	1.2 V	PJ			
NCV8187AMT180TAG	1.8 V	PK			
NCV8187AMT330TAG	3.3 V	PL			
NCV8187AMN120TAG	1.2 V	NA	With Active Output Discharge	DFN6 3x3 non WF (Pb-Free)	3,000 / Tape & Reel
NCV8187AMN180TAG	1.8 V	NH			
NCV8187AMTWADJTAG	ADJ	K2	With Active Output Discharge	WDFNW6 2x2 WF SLP (Pb-Free)	3,000 / Tape & Reel
NCV8187AMTW080TAG	0.8 V	KG			
NCV8187AMTW090TAG	0.9 V	KH			
NCV8187AMTW110TAG	1.1 V	KM			
NCV8187AML120TAG	1.2 V	WD	With Active Output Discharge	DFNW6 3x3 WF SLP (Pb-Free)	3,000 / Tape & Reel
NCV8187AML180TAG	1.8 V	WE			
NCV8187AMLE120TCG	1.2 V	CA	With Active Output Discharge	DFNW8 3x3 WF (Pb-Free)	3,000 / Tape & Reel
NCV8187AMLE180TCG	1.8 V	CC			
NCV8187AMLE280TCG	2.8 V	CE			
NCV8187AMLE330TCG	3.3 V	CD			
NCV8187AMLEADJTCG	ADJ	C2			
NCV8187ADT180RKG*	1.8 V	V8187BG	With Active Output Discharge	DPAK-5 (Pb-Free)	2,500 / Tape & Reel
NCV8187ADT330RKG*	3.3 V	V8187CG			
NCV8187ADTADJRKG*	ADJ	V8187AG			

<sup>†</sup>For information on tape and reel specifications, including part orientation and tape sizes, please refer to our Tape and Reel Packaging Specifications Brochure, BRD8011/D.

\*Package in development.

# MECHANICAL CASE OUTLINE

## PACKAGE DIMENSIONS

ON Semiconductor®

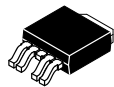

### DPAK-5, CENTER LEAD CROP

#### CASE 175AA

#### ISSUE B

DATE 15 MAY 2014

SCALE 1:1



- NOTES:
1. DIMENSIONING AND TOLERANCING PER ANSI Y14.5M, 1982.
  2. CONTROLLING DIMENSION: INCH.

DIM	INCHES		MILLIMETERS	
	MIN	MAX	MIN	MAX
A	0.235	0.245	5.97	6.22
B	0.250	0.265	6.35	6.73
C	0.086	0.094	2.19	2.38
D	0.020	0.028	0.51	0.71
E	0.018	0.023	0.46	0.58
F	0.024	0.032	0.61	0.81
G	0.180 BSC		4.56 BSC	
H	0.034	0.040	0.87	1.01
J	0.018	0.023	0.46	0.58
K	0.102	0.114	2.60	2.89
L	0.045 BSC		1.14 BSC	
R	0.170	0.190	4.32	4.83
R1	0.185	0.210	4.70	5.33
S	0.025	0.040	0.63	1.01
U	0.020	---	0.51	---
V	0.035	0.050	0.89	1.27
Z	0.155	0.170	3.93	4.32

### RECOMMENDED SOLDERING FOOTPRINT\*



\*For additional information on our Pb-Free strategy and soldering details, please download the ON Semiconductor Soldering and Mounting Techniques Reference Manual, SOLDERRM/D.

### GENERIC MARKING DIAGRAMS\*

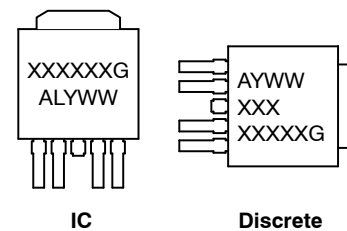

- XXXXXX = Device Code
- A = Assembly Location
- L = Wafer Lot
- Y = Year
- WW = Work Week
- G = Pb-Free Package

\*This information is generic. Please refer to device data sheet for actual part marking. Pb-Free indicator, "G" or microdot "▪", may or may not be present.

<b>DOCUMENT NUMBER:</b>	<b>98AON12855D</b>	Electronic versions are uncontrolled except when accessed directly from the Document Repository. Printed versions are uncontrolled except when stamped "CONTROLLED COPY" in red.
<b>DESCRIPTION:</b>	<b>DPAK-5 CENTER LEAD CROP</b>	<b>PAGE 1 OF 1</b>

ON Semiconductor and are trademarks of Semiconductor Components Industries, LLC dba ON Semiconductor or its subsidiaries in the United States and/or other countries. ON Semiconductor reserves the right to make changes without further notice to any products herein. ON Semiconductor makes no warranty, representation or guarantee regarding the suitability of its products for any particular purpose, nor does ON Semiconductor assume any liability arising out of the application or use of any product or circuit, and specifically disclaims any and all liability, including without limitation special, consequential or incidental damages. ON Semiconductor does not convey any license under its patent rights nor the rights of others.

# MECHANICAL CASE OUTLINE

## PACKAGE DIMENSIONS

ON Semiconductor®



SCALE 2:1

DFN6 3x3, 0.95P  
CASE 506DK  
ISSUE O

DATE 23 JUN 2016

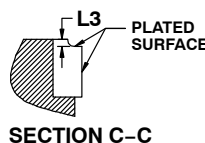
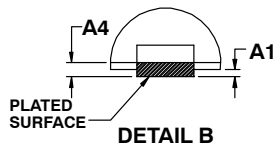
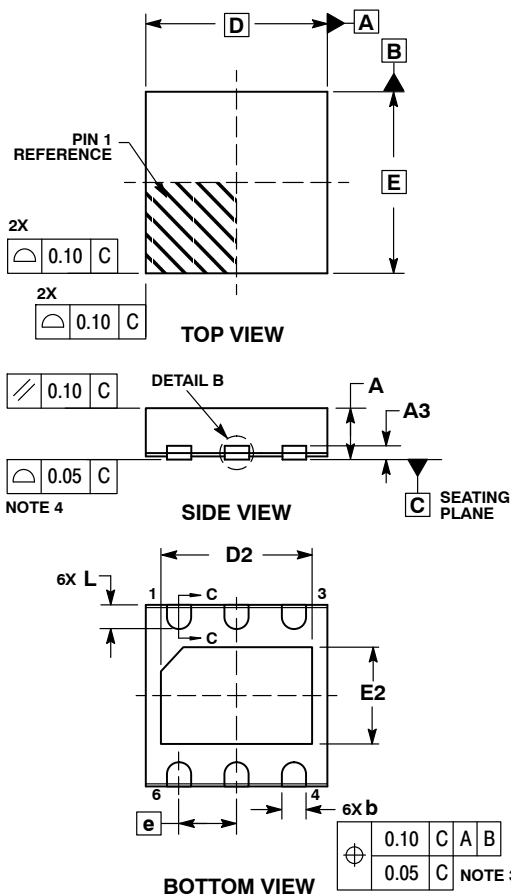

NOTES:

1. DIMENSIONS AND TOLERANCING PER ASME Y14.5M, 1994.
2. CONTROLLING DIMENSION: MILLIMETERS.
3. DIMENSION b APPLIES TO PLATED TERMINAL AND IS MEASURED BETWEEN 0.15 AND 0.20 MM FROM THE TERMINAL TIP.
4. COPLANARITY APPLIES TO THE EXPOSED PAD AS WELL AS THE TERMINALS.

DIM	MILLIMETERS	
	MIN	MAX
A	0.75	0.95
A1	0.00	0.05
A3	0.20	REF
A4	0.05	0.15
b	0.35	0.45
D	3.00	BSC
D2	2.40	2.60
E	3.00	BSC
E2	1.50	1.70
e	0.95	BSC
L	0.30	0.50
L3	0.00	0.10

### GENERIC MARKING DIAGRAM\*

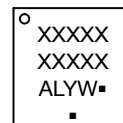

- XXXXX = Specific Device Code
- A = Assembly Location
- L = Wafer Lot
- Y = Year
- W = Work Week
- = Pb-Free Package

(Note: Microdot may be in either location)

\*This information is generic. Please refer to device data sheet for actual part marking.  
Pb-Free indicator, "G" or microdot "▪", may or may not be present.

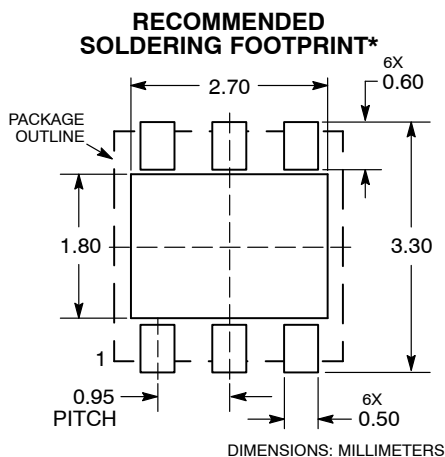

\*For additional information on our Pb-Free strategy and soldering details, please download the ON Semiconductor Soldering and Mounting Techniques Reference Manual, SOLDERRM/D.

<b>DOCUMENT NUMBER:</b>	<b>98AON12549G</b>	Electronic versions are uncontrolled except when accessed directly from the Document Repository. Printed versions are uncontrolled except when stamped "CONTROLLED COPY" in red.
<b>DESCRIPTION:</b>	<b>DFN6 3X3, 0.95P</b>	<b>PAGE 1 OF 1</b>

ON Semiconductor and ON are trademarks of Semiconductor Components Industries, LLC dba ON Semiconductor or its subsidiaries in the United States and/or other countries. ON Semiconductor reserves the right to make changes without further notice to any products herein. ON Semiconductor makes no warranty, representation or guarantee regarding the suitability of its products for any particular purpose, nor does ON Semiconductor assume any liability arising out of the application or use of any product or circuit, and specifically disclaims any and all liability, including without limitation special, consequential or incidental damages. ON Semiconductor does not convey any license under its patent rights nor the rights of others.

# MECHANICAL CASE OUTLINE

## PACKAGE DIMENSIONS

ON Semiconductor®



SCALE 2:1

DFNW8 3x3, 0.65P  
CASE 507AD  
ISSUE A

DATE 15 JUN 2018

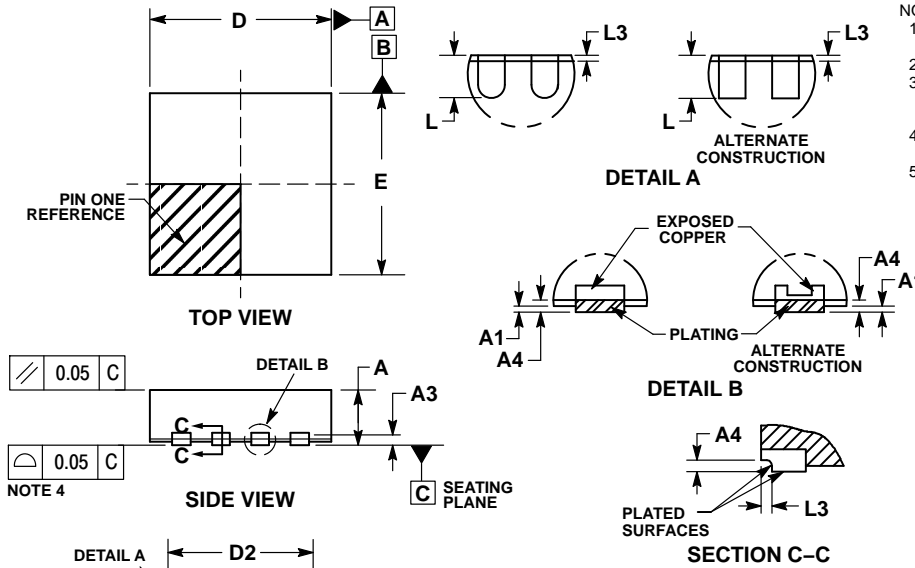

- NOTES:
1. DIMENSIONING AND TOLERANCING PER ASME Y14.5M, 1994.
  2. CONTROLLING DIMENSION: MILLIMETERS.
  3. DIMENSION b APPLIES TO PLATED TERMINAL AND IS MEASURED BETWEEN 0.15 AND 0.30mm FROM THE TERMINAL TIP.
  4. COPLANARITY APPLIES TO THE EXPOSED PAD AS WELL AS THE TERMINALS.
  5. THIS DEVICE CONTAINS WETTABLE FLANK DESIGN FEATURE TO AID IN FILLET FORMATION ON THE LEADS DURING MOUNTING.

MILLIMETERS			
DIM	MIN	NOM	MAX
A	0.80	0.90	1.00
A1	---	---	0.05
A3	0.20 REF		
A4	0.10	---	---
b	0.25	0.30	0.35
D	2.90	3.00	3.10
D2	2.30	2.40	2.50
E	2.90	3.00	3.10
E2	1.55	1.65	1.75
e	0.65 BSC		
K	0.28 REF		
L	0.30	0.40	0.50
L3	0.05 REF		

### GENERIC MARKING DIAGRAM\*

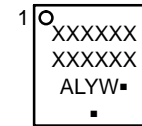

- XXXXXX = Specific Device Code  
 A = Assembly Location  
 L = Wafer Lot  
 Y = Year  
 W = Work Week  
 ■ = Pb-Free Package

(Note: Microdot may be in either location)

\*This information is generic. Please refer to device data sheet for actual part marking. Pb-Free indicator, "G" or microdot "■", may or may not be present. Some products may not follow the Generic Marking.

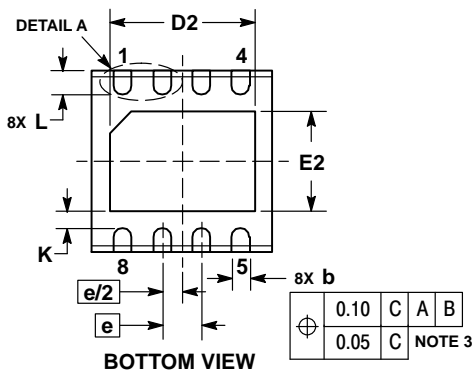

### RECOMMENDED SOLDERING FOOTPRINT\*

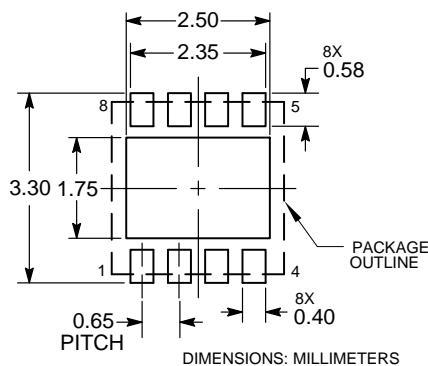

\*For additional information on our Pb-Free strategy and soldering details, please download the ON Semiconductor Soldering and Mounting Techniques Reference Manual, SOLDERRM/D.

<b>DOCUMENT NUMBER:</b>	<b>98AON17792G</b>	Electronic versions are uncontrolled except when accessed directly from the Document Repository. Printed versions are uncontrolled except when stamped "CONTROLLED COPY" in red.
<b>DESCRIPTION:</b>	<b>DFNW8 3x3, 0.65P</b>	<b>PAGE 1 OF 1</b>

ON Semiconductor and ON are trademarks of Semiconductor Components Industries, LLC dba ON Semiconductor or its subsidiaries in the United States and/or other countries. ON Semiconductor reserves the right to make changes without further notice to any products herein. ON Semiconductor makes no warranty, representation or guarantee regarding the suitability of its products for any particular purpose, nor does ON Semiconductor assume any liability arising out of the application or use of any product or circuit, and specifically disclaims any and all liability, including without limitation special, consequential or incidental damages. ON Semiconductor does not convey any license under its patent rights nor the rights of others.

# MECHANICAL CASE OUTLINE

## PACKAGE DIMENSIONS

ON Semiconductor®



**DFNW6 3X3, 0.95P**  
**CASE 507AW**  
**ISSUE O**

DATE 21 MAY 2019

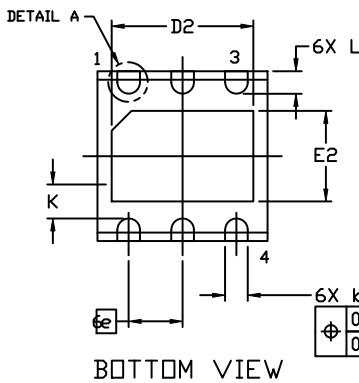
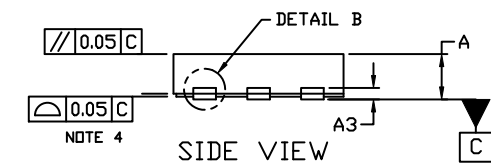
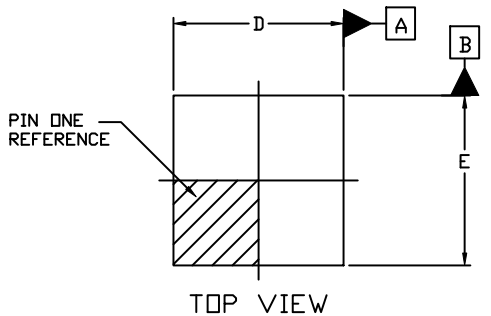

**GENERIC MARKING DIAGRAM\***

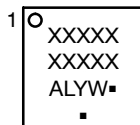

- XXXXX = Specific Device Code
- A = Assembly Location
- L = Wafer Lot
- Y = Year
- W = Work Week
- = Pb-Free Package

\*This information is generic. Please refer to device data sheet for actual part marking. Pb-Free indicator, "G" or microdot "▪", may or may not be present. Some products may not follow the Generic Marking.

**NOTES:**

1. DIMENSIONING AND TOLERANCING PER ASME Y14.5M, 1994.
2. CONTROLLING DIMENSION: MILLIMETERS
3. DIMENSION b APPLIES TO PLATED TERMINAL AND IS MEASURED BETWEEN 0.15 AND 0.30 MM FROM THE TERMINAL TIP.
4. COPLANARITY APPLIES TO THE EXPOSED PADS AS WELL AS THE TERMINALS.

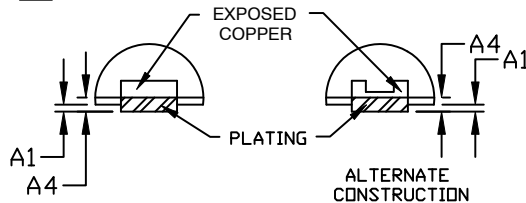
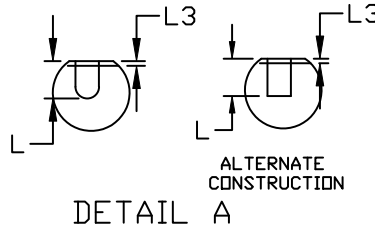

**DETAIL B**

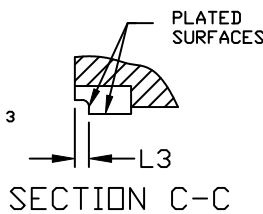

DIM	MILLIMETERS		
	MIN.	NOM.	MAX.
A	0.80	0.90	1.00
A1	0.00	---	0.05
A3	0.20 REF		
A4	0.10	---	---
b	0.35	0.40	0.45
D	2.90	3.00	3.10
D2	2.40	2.50	2.60
E	2.90	3.00	3.10
E2	1.50	1.60	1.70
e	0.95 BSC		
K	0.30	---	---
L	0.30	0.40	0.50
L3	---	---	0.10

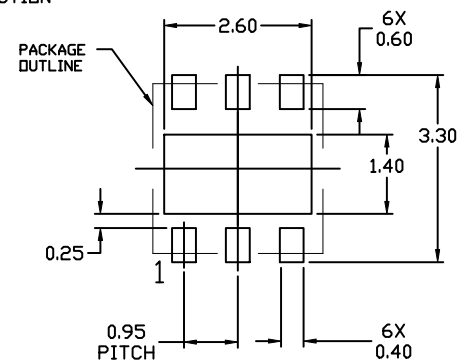

**RECOMMENDED MOUNTING FOOTPRINT**

\* For additional information on our Pb-Free strategy and soldering details, please download the ON Semiconductor Soldering and Mounting Techniques Reference Manual, SOLDERM/D.

<b>DOCUMENT NUMBER:</b>	<b>98AON07566H</b>	Electronic versions are uncontrolled except when accessed directly from the Document Repository. Printed versions are uncontrolled except when stamped "CONTROLLED COPY" in red.
<b>DESCRIPTION:</b>	<b>DFNW6 3X3, 0.95P</b>	<b>PAGE 1 OF 1</b>

ON Semiconductor and are trademarks of Semiconductor Components Industries, LLC dba ON Semiconductor or its subsidiaries in the United States and/or other countries. ON Semiconductor reserves the right to make changes without further notice to any products herein. ON Semiconductor makes no warranty, representation or guarantee regarding the suitability of its products for any particular purpose, nor does ON Semiconductor assume any liability arising out of the application or use of any product or circuit, and specifically disclaims any and all liability, including without limitation special, consequential or incidental damages. ON Semiconductor does not convey any license under its patent rights nor the rights of others.

# MECHANICAL CASE OUTLINE

## PACKAGE DIMENSIONS

ON Semiconductor®



SCALE 4:1

WDFN6 2x2, 0.65P  
CASE 511BR  
ISSUE B

DATE 19 JAN 2016

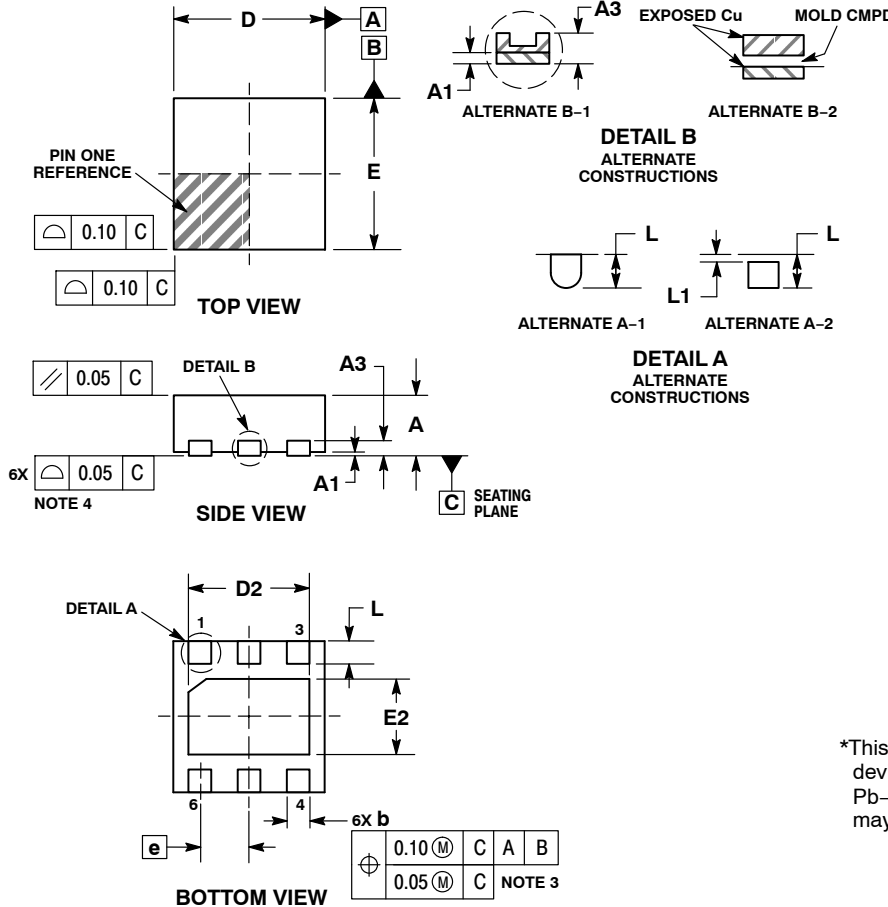

- NOTES:
1. DIMENSIONING AND TOLERANCING PER ASME Y14.5M, 1994.
  2. CONTROLLING DIMENSION: MILLIMETERS.
  3. DIMENSION b APPLIES TO PLATED TERMINAL AND IS MEASURED BETWEEN 0.15 AND 0.25 mm FROM THE TERMINAL TIP.
  4. COPLANARITY APPLIES TO THE EXPOSED PAD AS WELL AS THE TERMINALS.
  5. FOR DEVICES CONTAINING WETTABLE FLANK OPTION, DETAIL A ALTERNATE CONSTRUCTION A-2 AND DETAIL B ALTERNATE CONSTRUCTION B-2 ARE NOT APPLICABLE.

DIM	MILLIMETERS	
	MIN	MAX
A	0.70	0.80
A1	0.00	0.05
A3	0.20	REF
b	0.25	0.35
D	2.00 BSC	
D2	1.50	1.70
E	2.00 BSC	
E2	0.90	1.10
e	0.65 BSC	
L	0.20	0.40
L1	---	0.15

### GENERIC MARKING DIAGRAM\*

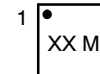

XX = Specific Device Code  
M = Date Code

\*This information is generic. Please refer to device data sheet for actual part marking. Pb-Free indicator, "G" or microdot "▪", may or may not be present.

### RECOMMENDED MOUNTING FOOTPRINT

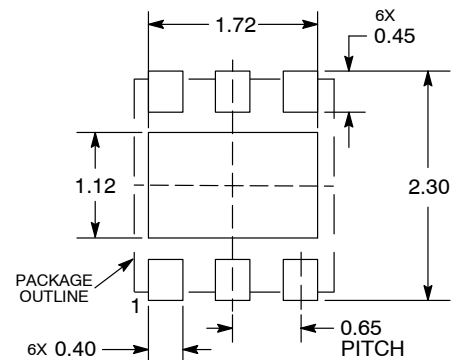

DIMENSIONS: MILLIMETERS

<b>DOCUMENT NUMBER:</b>	<b>98AON55829E</b>	Electronic versions are uncontrolled except when accessed directly from the Document Repository. Printed versions are uncontrolled except when stamped "CONTROLLED COPY" in red.
<b>DESCRIPTION:</b>	<b>WDFN6 2X2, 0.65P</b>	<b>PAGE 1 OF 1</b>

ON Semiconductor and are trademarks of Semiconductor Components Industries, LLC dba ON Semiconductor or its subsidiaries in the United States and/or other countries. ON Semiconductor reserves the right to make changes without further notice to any products herein. ON Semiconductor makes no warranty, representation or guarantee regarding the suitability of its products for any particular purpose, nor does ON Semiconductor assume any liability arising out of the application or use of any product or circuit, and specifically disclaims any and all liability, including without limitation special, consequential or incidental damages. ON Semiconductor does not convey any license under its patent rights nor the rights of others.

# MECHANICAL CASE OUTLINE

## PACKAGE DIMENSIONS

ON Semiconductor®



### WDFNW6 2x2, 0.65P CASE 511DW ISSUE B

DATE 15 JUN 2018

SCALE 4:1

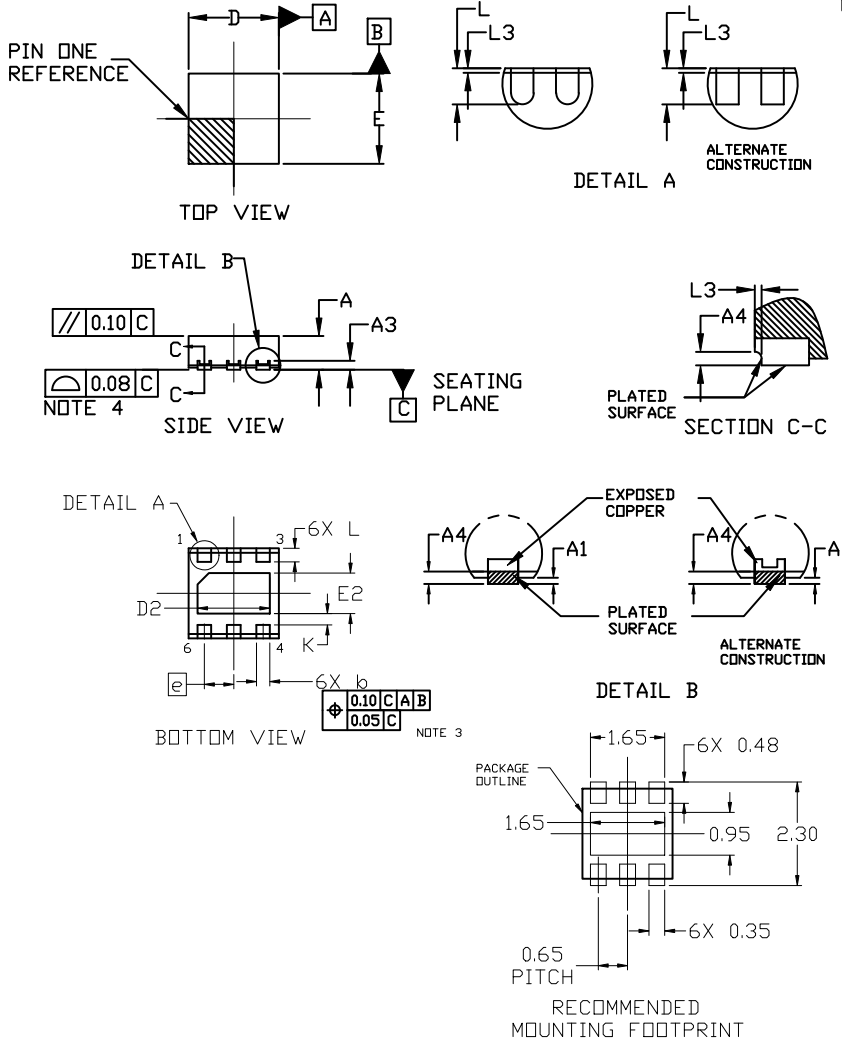

**NOTES:**

1. DIMENSIONING AND TOLERANCING PER ASME Y14.5M, 1994.
2. CONTROLLING DIMENSION: MILLIMETERS
3. DIMENSION *b* APPLIES TO PLATED TERMINALS AND IS MEASURED BETWEEN 0.15 AND 0.30MM FROM THE TERMINAL TIP.
4. COPLANARITY APPLIES TO THE EXPOSED PAD AS WELL AS THE TERMINALS.
5. THIS DEVICE CONTAINS WETTABLE FLANK DESIGN FEATURES TO AID IN FILLET FORMATION ON THE LEADS DURING MOUNTING.

DIM	MILLIMETERS		
	MIN.	NOM.	MAX.
A	0.70	0.75	0.80
A1	---	---	0.05
A3	0.20 REF		
A4	0.10	---	---
<i>b</i>	0.25	0.30	0.35
D	1.90	2.00	2.10
D2	1.50	1.60	1.70
E	1.90	2.00	2.10
E2	0.80	0.90	1.00
<i>e</i>	0.65 BSC		
K	0.25 REF		
L	0.25	0.30	0.35
L3	0.05 REF		

**GENERIC MARKING DIAGRAM\***

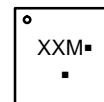

- M = Month Code
- = Pb-Free Package

(Note: Microdot may be in either location)

\*This information is generic. Please refer to device data sheet for actual part marking. Pb-Free indicator, "G" or microdot "▪", may or may not be present. Some products may not follow the Generic Marking.

<b>DOCUMENT NUMBER:</b>	<b>98AON79327G</b>	Electronic versions are uncontrolled except when accessed directly from the Document Repository. Printed versions are uncontrolled except when stamped "CONTROLLED COPY" in red.
<b>DESCRIPTION:</b>	<b>WDFNW6 2x2, 0.65P</b>	<b>PAGE 1 OF 1</b>

ON Semiconductor and are trademarks of Semiconductor Components Industries, LLC dba ON Semiconductor or its subsidiaries in the United States and/or other countries. ON Semiconductor reserves the right to make changes without further notice to any products herein. ON Semiconductor makes no warranty, representation or guarantee regarding the suitability of its products for any particular purpose, nor does ON Semiconductor assume any liability arising out of the application or use of any product or circuit, and specifically disclaims any and all liability, including without limitation special, consequential or incidental damages. ON Semiconductor does not convey any license under its patent rights nor the rights of others.



ON Semiconductor and  are trademarks of Semiconductor Components Industries, LLC dba ON Semiconductor or its subsidiaries in the United States and/or other countries. ON Semiconductor owns the rights to a number of patents, trademarks, copyrights, trade secrets, and other intellectual property. A listing of ON Semiconductor's product/patent coverage may be accessed at [www.onsemi.com/site/pdf/Patent-Marking.pdf](http://www.onsemi.com/site/pdf/Patent-Marking.pdf). ON Semiconductor reserves the right to make changes without further notice to any products herein. ON Semiconductor makes no warranty, representation or guarantee regarding the suitability of its products for any particular purpose, nor does ON Semiconductor assume any liability arising out of the application or use of any product or circuit, and specifically disclaims any and all liability, including without limitation special, consequential or incidental damages. Buyer is responsible for its products and applications using ON Semiconductor products, including compliance with all laws, regulations and safety requirements or standards, regardless of any support or applications information provided by ON Semiconductor. "Typical" parameters which may be provided in ON Semiconductor data sheets and/or specifications can and do vary in different applications and actual performance may vary over time. All operating parameters, including "Typicals" must be validated for each customer application by customer's technical experts. ON Semiconductor does not convey any license under its patent rights nor the rights of others. ON Semiconductor products are not designed, intended, or authorized for use as a critical component in life support systems or any FDA Class 3 medical devices or medical devices with a same or similar classification in a foreign jurisdiction or any devices intended for implantation in the human body. Should Buyer purchase or use ON Semiconductor products for any such unintended or unauthorized application, Buyer shall indemnify and hold ON Semiconductor and its officers, employees, subsidiaries, affiliates, and distributors harmless against all claims, costs, damages, and expenses, and reasonable attorney fees arising out of, directly or indirectly, any claim of personal injury or death associated with such unintended or unauthorized use, even if such claim alleges that ON Semiconductor was negligent regarding the design or manufacture of the part. ON Semiconductor is an Equal Opportunity/Affirmative Action Employer. This literature is subject to all applicable copyright laws and is not for resale in any manner.

## PUBLICATION ORDERING INFORMATION

### LITERATURE FULFILLMENT:

Email Requests to: [orderlit@onsemi.com](mailto:orderlit@onsemi.com)

ON Semiconductor Website: [www.onsemi.com](http://www.onsemi.com)

### TECHNICAL SUPPORT

North American Technical Support:  
Voice Mail: 1 800-282-9855 Toll Free USA/Canada  
Phone: 011 421 33 790 2910

Europe, Middle East and Africa Technical Support:

Phone: 00421 33 790 2910

For additional information, please contact your local Sales Representative