

NCV8152

Voltage Regulator - Dual, Low I_Q, Low Dropout

150 mA

The NCV8152 is 150 mA, Dual Output Linear Voltage Regulator. Device provides a very stable and accurate voltage with ultra low noise and very high Power Supply Rejection Ratio (PSRR) suitable for RF applications. The NCV8152 is suitable for powering RF blocks of automotive infotainment systems and other power sensitive device. Due to low power consumption the NCV8152 offers high efficiency and low thermal dissipation.

Features

- Operating Input Voltage Range: 1.9 V to 5.25 V
- Two Independent Output Voltages:
(for details please refer to the Ordering Information section)
- Very Low Dropout: 150 mV Typical at 150 mA
- Low I_Q of typ. 50 μ A per Channel
- High PSRR: 75 dB at 1 kHz
- Two Independent Enable Pins
- Thermal Shutdown and Current Limit Protections
- Stable with a 0.22 μ F Ceramic Output Capacitor
- Available in XDFN6 1.2 x 1.2 mm Package
- Active Output Discharge for Fast Output Turn-Off
- NCV Prefix for Automotive and Other Applications Requiring Unique Site and Control Change Requirements; AEC-Q100 Qualified and PPAP Capable; Device Temperature Grade 1: -40°C to +125°C Ambient Operating Temperature Range
- These are Pb-Free Devices

Typical Applications

- Wireless LAN, Bluetooth®, ZigBee® Interfaces
- Parking Camera Modules
- Automotive Infotainment Systems

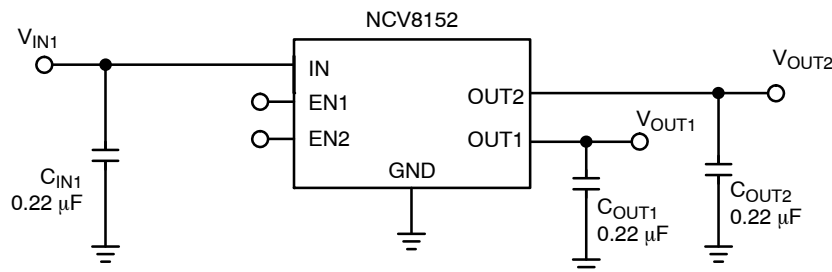

Figure 1. Typical Application Schematic



ON Semiconductor®

www.onsemi.com



XDFN6, 1.2x1.2
CASE 711AT

MARKING DIAGRAM



XX = Specific Device Code
M = Date Code

PIN CONNECTIONS

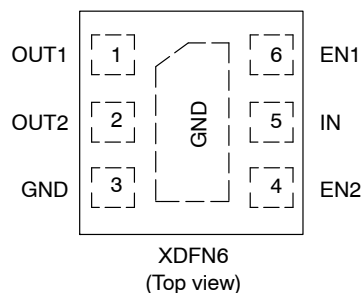

ORDERING INFORMATION

See detailed ordering and shipping information on page 16 of this data sheet.

NCV8152

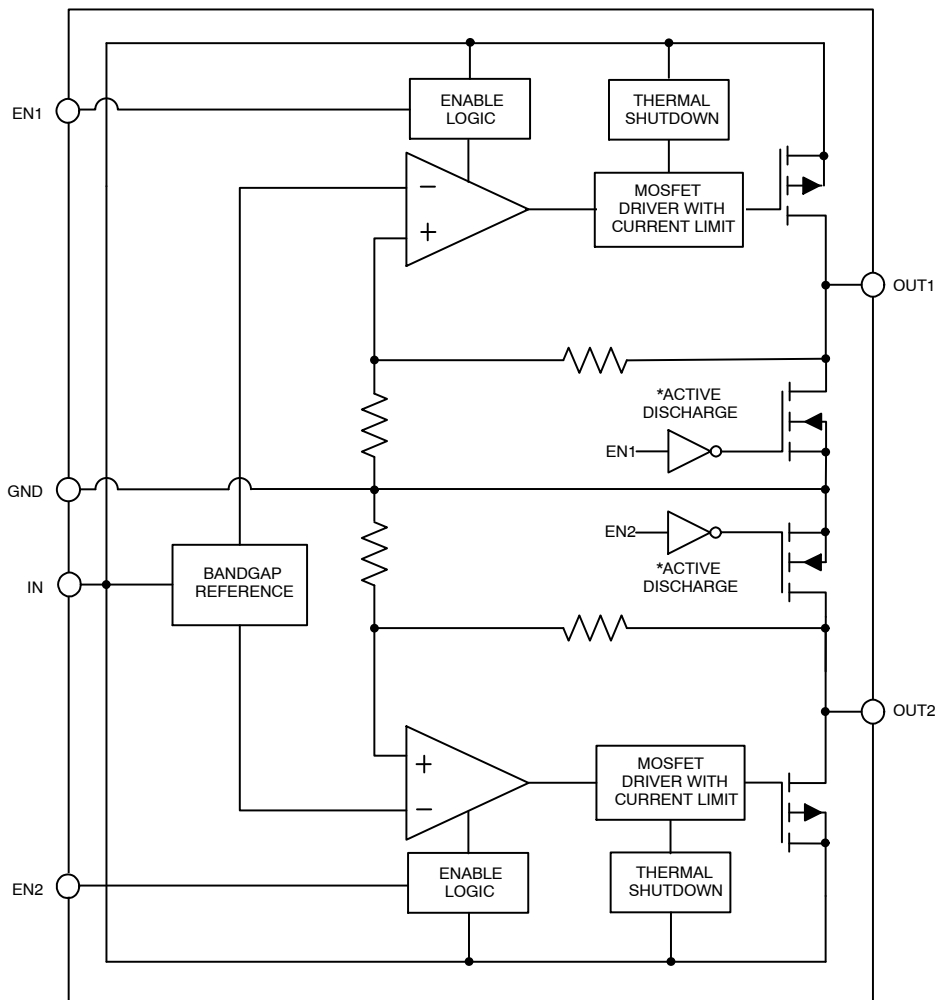

Figure 2. Simplified Schematic Block Diagram

PIN FUNCTION DESCRIPTION

Pin No. XDFN6	Pin Name	Description
1	OUT1	Regulated output voltage of the first channel. A small 0.22 μ F ceramic capacitor is needed from this pin to ground to assure stability.
2	OUT2	Regulated output voltage of the second channel. A small 0.22 μ F ceramic capacitor is needed from this pin to ground to assure stability.
3	GND	Power supply ground. Soldered to the copper plane allows for effective heat dissipation.
4	EN2	Driving EN2 over 0.9 V turns-on OUT2. Driving EN below 0.4 V turns-off the OUT2 and activates the active discharge.
5	IN	Input pin common for both channels. It is recommended to connect 0.22 μ F ceramic capacitor close to the device pin.
6	EN1	Driving EN1 over 0.9 V turns-on OUT1. Driving EN below 0.4 V turns-off the OUT1 and activates the active discharge.
-	EP	Exposed pad must be tied to ground. Soldered to the copper plane allows for effective thermal dissipation.

NCV8152

ABSOLUTE MAXIMUM RATINGS

Rating	Symbol	Value	Unit
Input Voltage (Note 1)	V_{IN}	-0.3 V to 6 V	V
Output Voltage	V_{OUT1} , V_{OUT2}	-0.3 V to $V_{IN} + 0.3$ V or 6 V	V
Enable Inputs	V_{EN1} , V_{EN2}	-0.3 V to $V_{IN} + 0.3$ V or 6 V	V
Output Short Circuit Duration	t_{SC}	Indefinite	s
Operating Ambient Temperature Range	T_A	-40 to +125	°C
Maximum Junction Temperature	$T_{J(MAX)}$	150	°C
Storage Temperature Range	T_{STG}	-55 to +150	°C
ESD Capability, Human Body Model (Note 2)	ESD _{HBM}	2000	V
ESD Capability, Machine Model (Note 2)	ESD _{MM}	200	V

Stresses exceeding Maximum Ratings may damage the device. Maximum Ratings are stress ratings only. Functional operation above the Recommended Operating Conditions is not implied. Extended exposure to stresses above the Recommended Operating Conditions may affect device reliability.

1. Refer to ELECTRICAL CHARACTERISTICS and APPLICATION INFORMATION for Safe Operating Area.

2. This device series incorporates ESD protection and is tested by the following methods:

ESD Human Body Model tested per EIA/JESD22-A114

ESD Machine Model tested per EIA/JESD22-A115

Latchup Current Maximum Rating tested per JEDEC standard: JESD78.

THERMAL CHARACTERISTICS (Note 3)

Rating	Symbol	Value	Unit
Thermal Characteristics, XDFN6 1.2 x 1.2 mm, Thermal Resistance, Junction-to-Air Thermal Characterization Parameter, Junction-to-Lead (Pin 2)	θ_{JA} θ_{JL}	170	°C/W

3. Single component mounted on 1 oz, FR4 PCB with 645mm² Cu area.

RECOMMENDED OPERATING CONDITIONS

Parameter	Symbol	Min	Max	Unit
Input Voltage	V_{IN}	1.9	5.25	V
Junction Temperature	T_J	-40	125	°C

Functional operation above the stresses listed in the Recommended Operating Ranges is not implied. Extended exposure to stresses beyond the Recommended Operating Ranges limits may affect device reliability.

NCV8152

ELECTRICAL CHARACTERISTIC

$-40^{\circ}\text{C} \leq T_J \leq 125^{\circ}\text{C}$; $V_{IN} = V_{OUT(NOM)} + 1\text{ V}$ or 2.5 V , whichever is greater; $V_{EN} = 0.9\text{ V}$, $I_{OUT} = 1\text{ mA}$, $C_{IN} = C_{OUT} = 0.22\text{ }\mu\text{F}$. Typical values are at $T_J = +25^{\circ}\text{C}$. Min/Max values are specified for $T_J = -40^{\circ}\text{C}$ and $T_J = 125^{\circ}\text{C}$ respectively. (Note 4)

Parameter	Test Conditions	Symbol	Min	Typ	Max	Unit
Operating Input Voltage		V_{IN}	1.9		5.25	V
Output Voltage Accuracy	$-40^{\circ}\text{C} \leq T_J \leq 125^{\circ}\text{C}$	$V_{OUT} > 2\text{ V}$	-2.8		+2.8	%
		$V_{OUT} \leq 2\text{ V}$	-80		+80	mV
Line Regulation	$V_{OUT} + 0.5\text{ V}$ or $2.5\text{ V} \leq V_{IN} \leq 5\text{ V}$	Reg_{LINE}		0.02	0.1	%/V
Load Regulation	$I_{OUT} = 1\text{ mA}$ to 150 mA	Reg_{LOAD}		15	50	mV
Dropout Voltage (Note 5)	$I_{out} = 150\text{ mA}$	$V_{OUT(nom)} = 1.8\text{ V}$		270	420	mV
		$V_{OUT(nom)} = 3.0\text{ V}$		150	240	
		$V_{OUT(nom)} = 3.3\text{ V}$		140	240	
Output Current Limit	$V_{OUT} = 90\% V_{OUT(nom)}$	I_{CL}	150			mA
Quiescent Current	$I_{OUT} = 0\text{ mA}$, $EN1 = V_{IN}$, $EN2 = 0\text{ V}$ or $EN2 = V_{IN}$, $EN1 = 0\text{ V}$	I_Q		50	100	μA
	$I_{OUT1} = I_{OUT2} = 0\text{ mA}$, $V_{EN1} = V_{EN2} = V_{IN}$	I_Q		85	200	μA
Shutdown current (Note 6)	$V_{EN} \leq 0.4\text{ V}$, $V_{IN} = 5.25\text{ V}$	I_{DIS}		0.1	1	μA
EN Pin Threshold Voltage High Threshold Low Threshold	V_{EN} Voltage increasing	V_{EN_HI}	0.9		0.4	V
	V_{EN} Voltage decreasing	V_{EN_LO}				
EN Pin Input Current	$V_{EN} = V_{IN} = 5.25\text{ V}$	I_{EN}		0.3	1.0	μA
Power Supply Rejection Ratio	$V_{IN} = V_{OUT} + 1\text{ V}$ for $V_{OUT} > 2\text{ V}$, $V_{IN} = 2.5\text{ V}$, for $V_{OUT} \leq 2\text{ V}$, $I_{OUT} = 10\text{ mA}$	$f = 1\text{ kHz}$	PSRR	75		dB
Output Noise Voltage	$f = 10\text{ Hz}$ to 100 kHz	V_N		75		μV_{rms}
Active Discharge Resistance	$V_{IN} = 4\text{ V}$, $V_{EN} < 0.4\text{ V}$	R_{DIS}		50		Ω
Thermal Shutdown Temperature	Temperature increasing from $T_J = +25^{\circ}\text{C}$	T_{SD}		160		$^{\circ}\text{C}$
Thermal Shutdown Hysteresis	Temperature falling from T_{SD}	T_{SDH}	-	20	-	$^{\circ}\text{C}$

Product parametric performance is indicated in the Electrical Characteristics for the listed test conditions, unless otherwise noted. Product performance may not be indicated by the Electrical Characteristics if operated under different conditions.

- Performance guaranteed over the indicated operating temperature range by design and/or characterization. Production tested at $T_J = T_A = 25^{\circ}\text{C}$. Low duty cycle pulse techniques are used during testing to maintain the junction temperature as close to ambient as possible.
- Characterized when V_{OUT} falls 100 mV below the regulated voltage at $V_{IN} = V_{OUT(NOM)} + 1\text{ V}$.
- Shutdown Current is the current flowing into the IN pin when the device is in the disable state.

TYPICAL CHARACTERISTICS

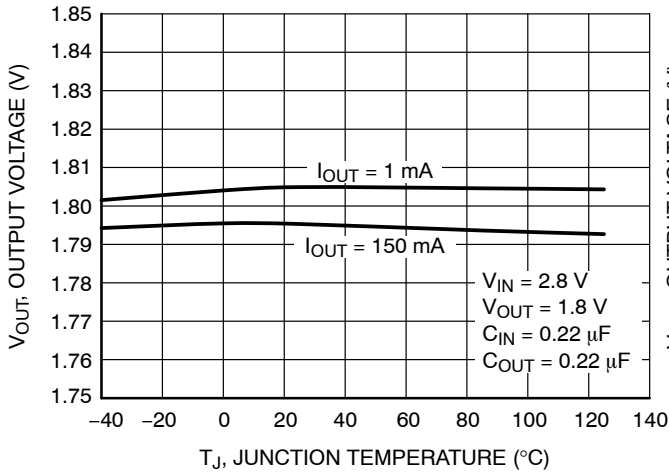

Figure 3. Output Voltage vs. Temperature
V_{OUT} = 1.8 V

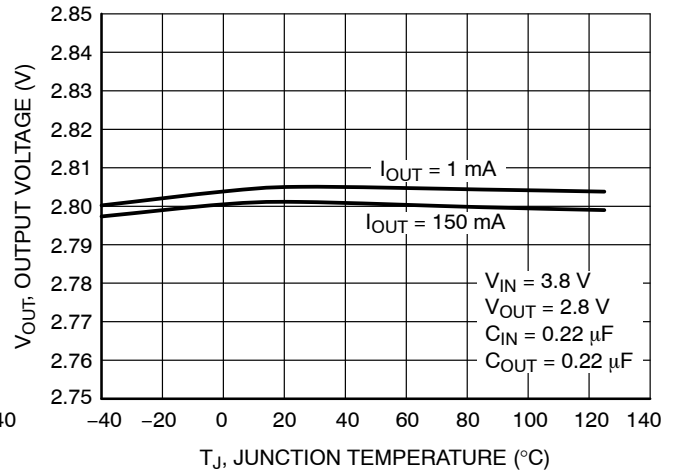

Figure 4. Output Voltage vs. Temperature
V_{OUT} = 2.8 V

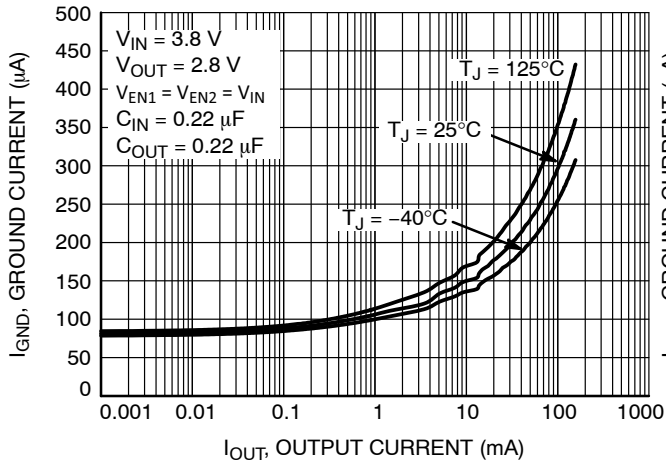

Figure 5. Ground Current vs. Output Current -
One Channel Load

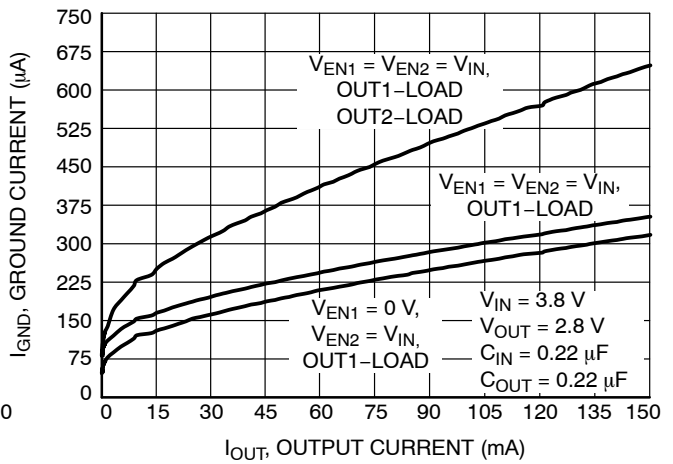

Figure 6. Ground Current vs. Output Current -
Different Load Combinations

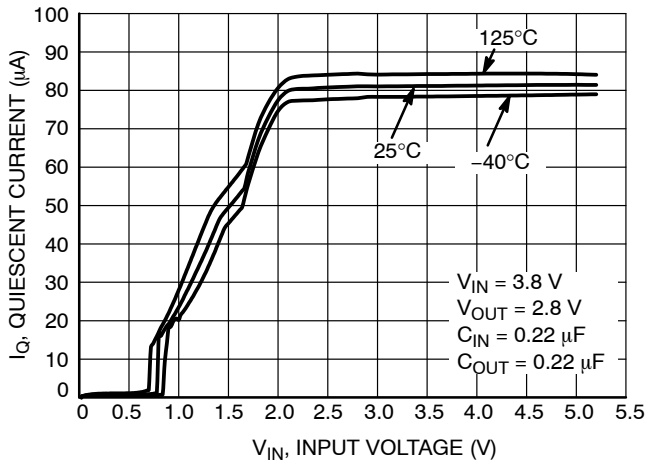

Figure 7. Quiescent Current vs. Input Voltage -
Both Outputs ON

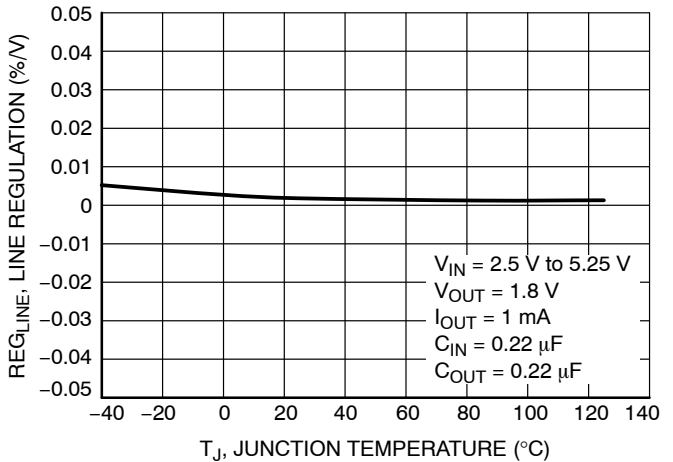

Figure 8. Line Regulation vs. Temperature
V_{OUT} = 1.8 V

TYPICAL CHARACTERISTICS

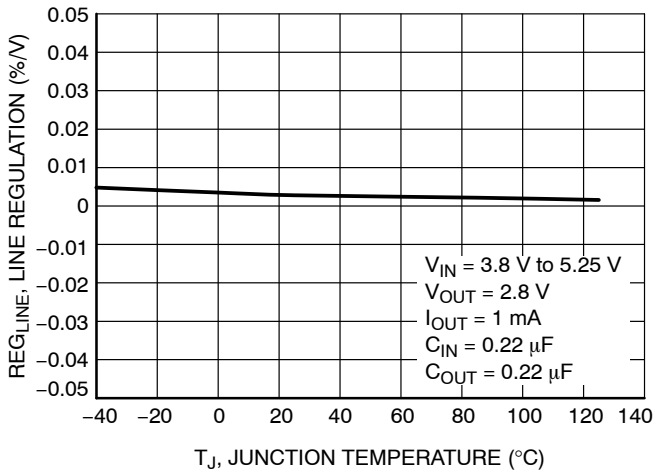

Figure 9. Line Regulation vs. Temperature
V_{OUT} = 2.8 V

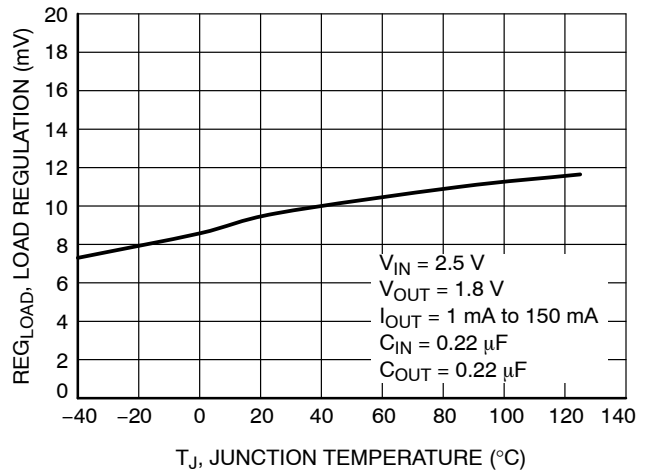

Figure 10. Load Regulation vs. Temperature
V_{OUT} = 1.8 V

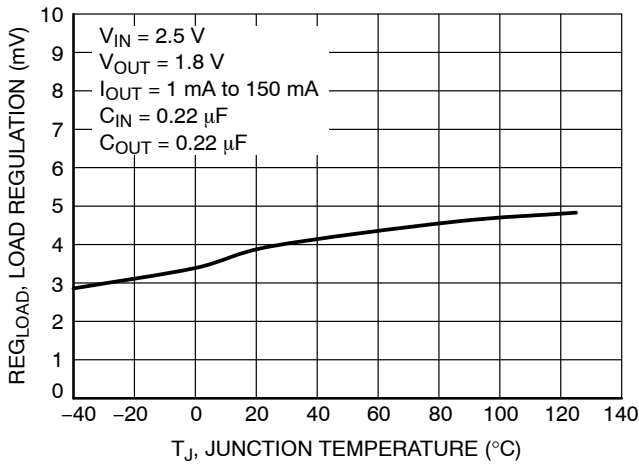

Figure 11. Load Regulation vs. Temperature
V_{OUT} = 2.8 V

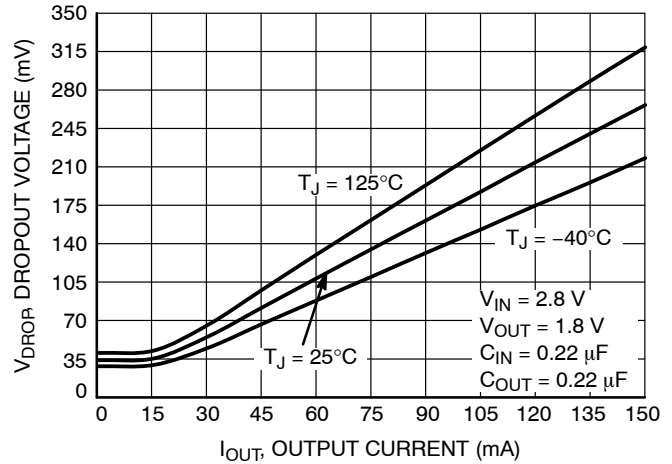

Figure 12. Dropout Voltage vs. Output Current
V_{OUT} = 1.8 V

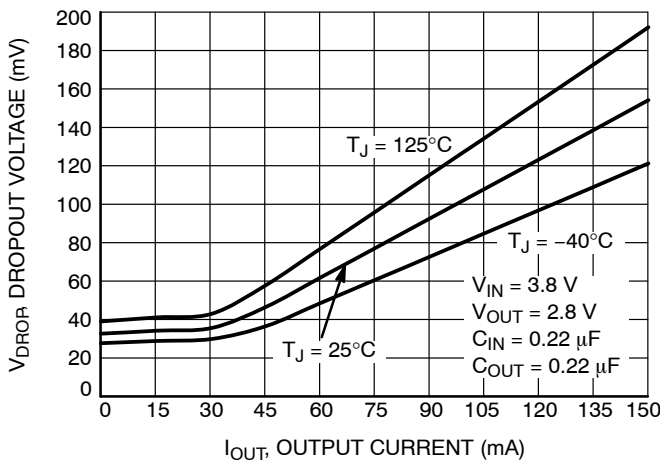

Figure 13. Dropout Voltage vs. Output Current
V_{OUT} = 2.8 V

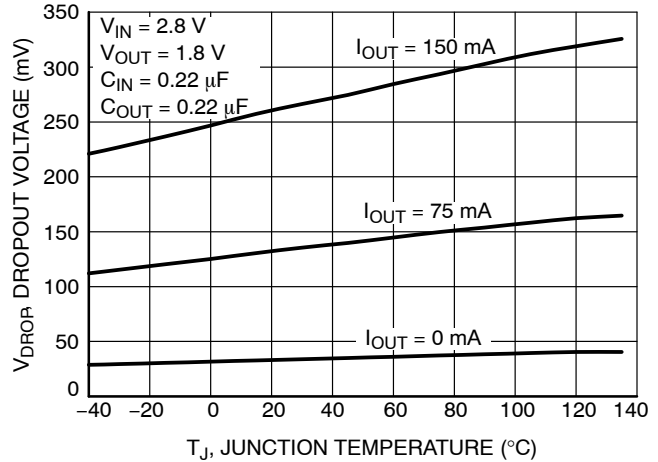

Figure 14. Dropout Voltage vs. Temperature
V_{OUT} = 1.8 V

TYPICAL CHARACTERISTICS

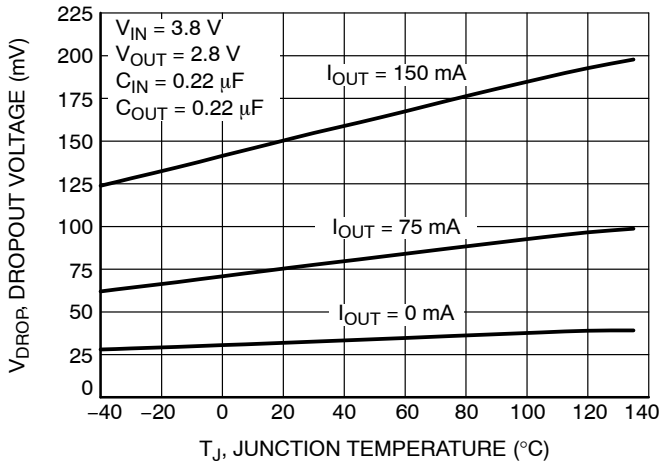

Figure 15. Dropout Voltage vs. Temperature
 $V_{OUT} = 2.8\text{ V}$

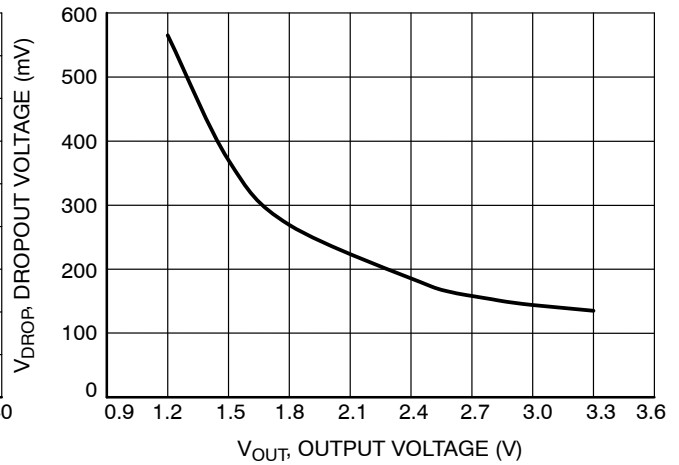

Figure 16. Dropout Voltage vs. Output Voltage

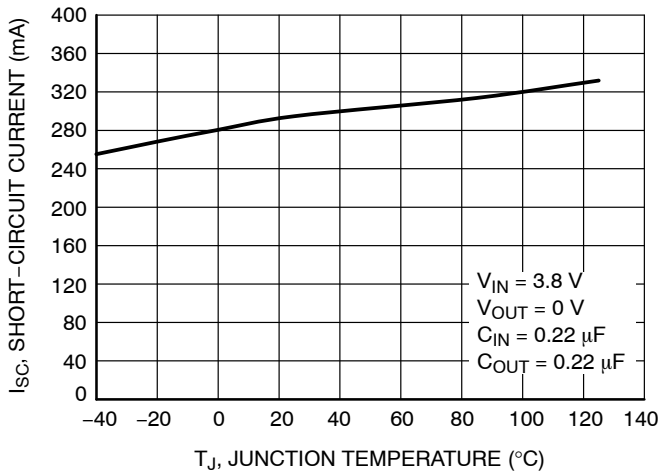

Figure 17. Short-Circuit Current vs. Temperature

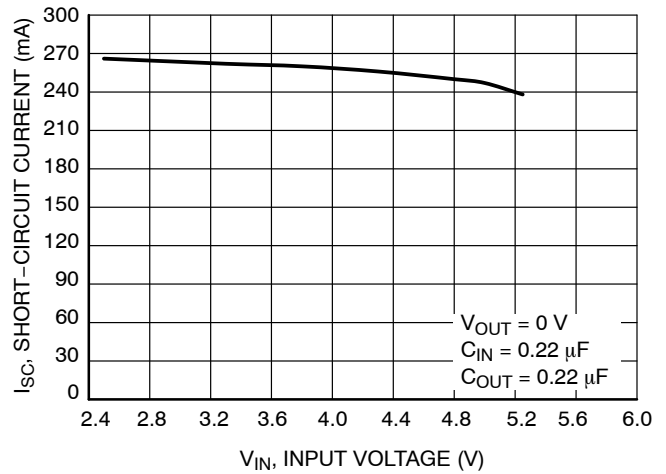

Figure 18. Short-Circuit Current vs. Input Voltage

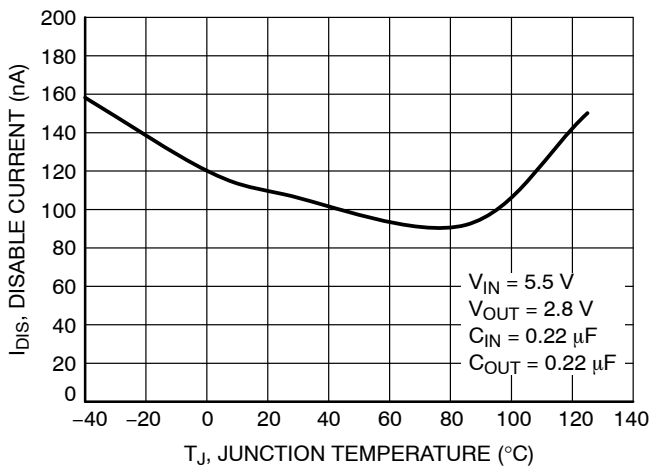

Figure 19. Disable Current vs. Temperature

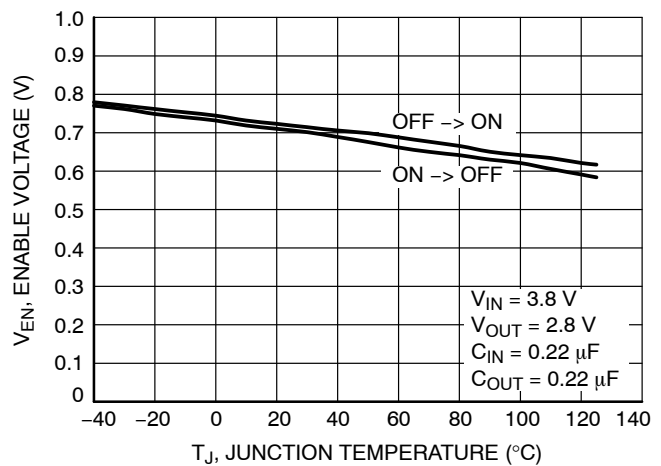

Figure 20. Enable Voltage Threshold vs. Temperature

TYPICAL CHARACTERISTICS

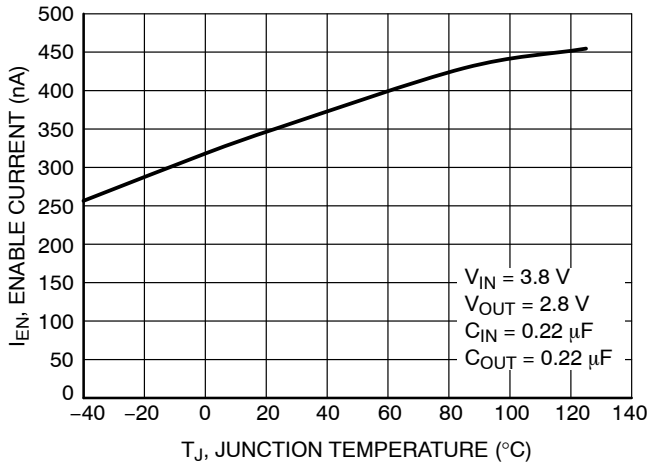

Figure 21. Current to Enable Pin vs. Temperature

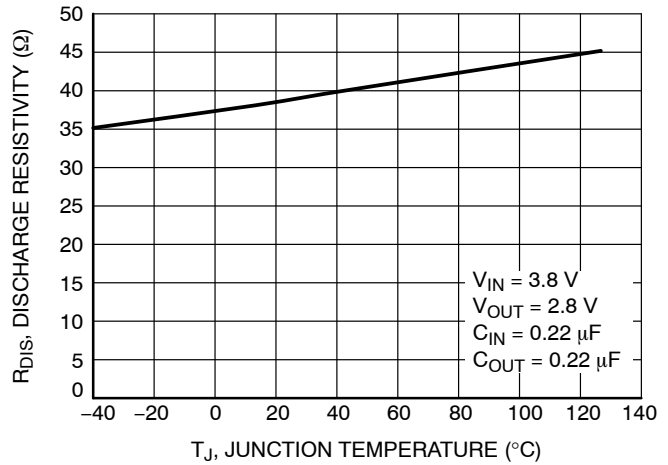

Figure 22. Discharge Resistance vs. Temperature

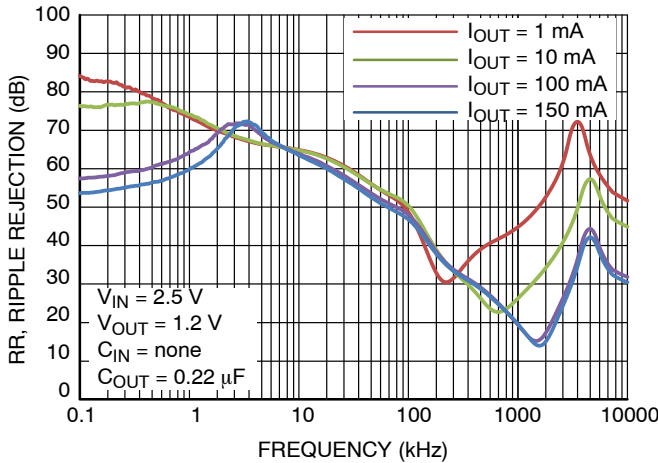

Figure 23. Power Supply Rejection Ratio, $V_{OUT} = 1.2\text{ V}$, $C_{OUT} = 0.22\ \mu\text{F}$

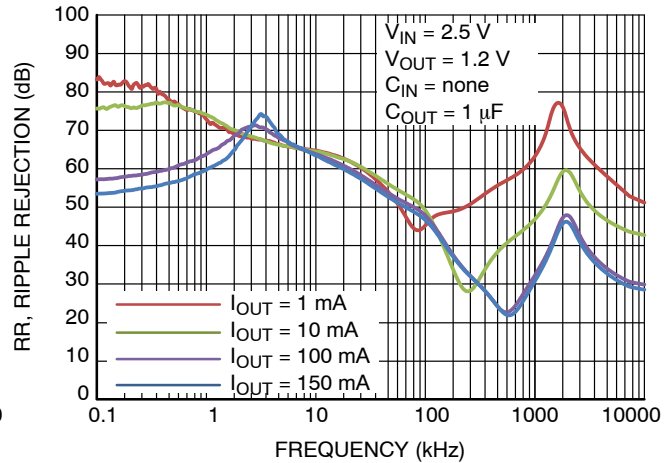

Figure 24. Power Supply Rejection Ratio, $V_{OUT} = 1.2\text{ V}$, $C_{OUT} = 1\ \mu\text{F}$

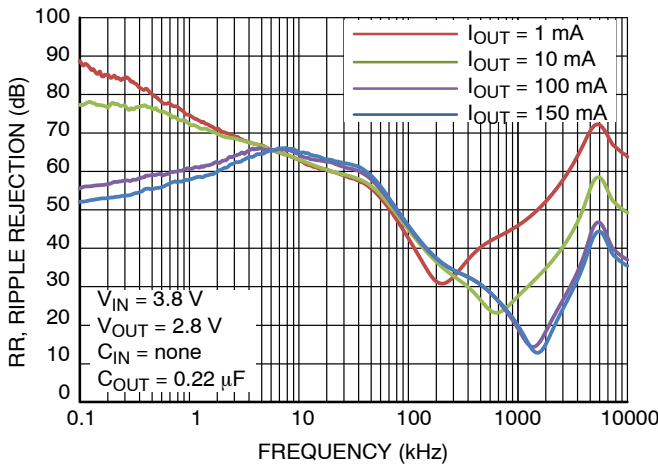

Figure 25. Power Supply Rejection Ratio, $V_{OUT} = 2.8\text{ V}$, $C_{OUT} = 0.22\ \mu\text{F}$

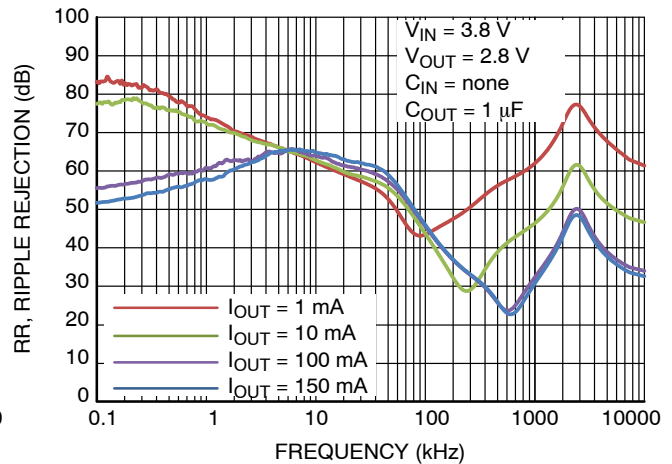
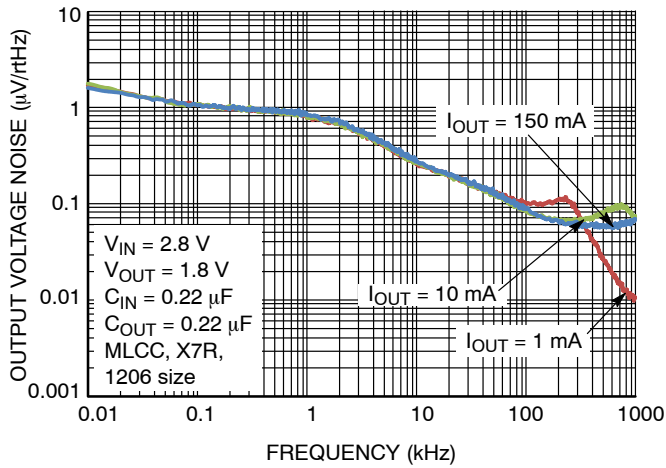
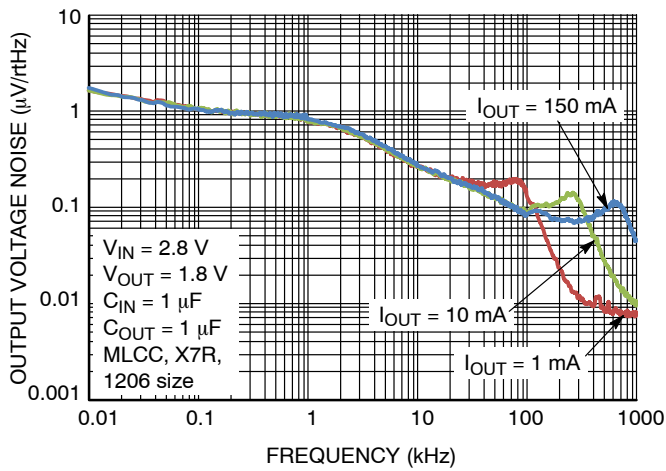

Figure 26. Power Supply Rejection Ratio, $V_{OUT} = 2.8\text{ V}$, $C_{OUT} = 1\ \mu\text{F}$



I _{OUT}	RMS Output Noise (µV)	
	10 Hz – 100 kHz	100 Hz – 100 kHz
1 mA	68.07	67.07
10 mA	67.30	66.31
150 mA	69.74	68.80

Figure 27. Output Voltage Noise Spectral Density for V_{OUT} = 1.8 V, C_{OUT} = 220 nF



I _{OUT}	RMS Output Noise (µV)	
	10 Hz – 100 kHz	100 Hz – 100 kHz
1 mA	76.23	75.33
10 mA	67.12	66.12
150 mA	69.06	68.12

Figure 28. Output Voltage Noise Spectral Density for V_{OUT} = 1.8 V, C_{OUT} = 1 µF

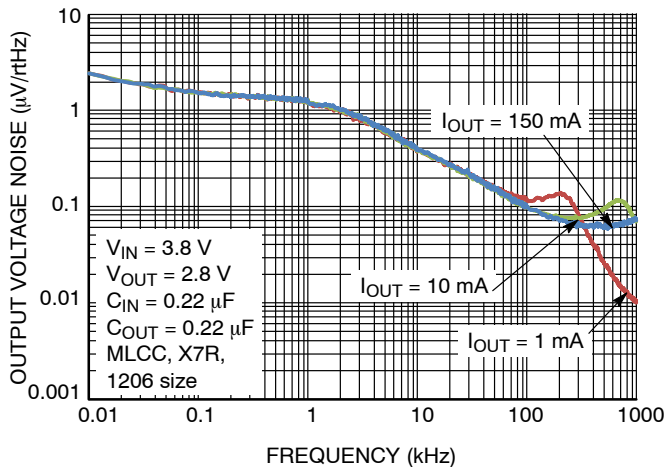

I _{OUT}	RMS Output Noise (µV)	
	10 Hz – 100 kHz	100 Hz – 100 kHz
1 mA	93.42	91.99
10 mA	92.88	91.45
150 mA	94.67	93.26

Figure 29. Output Voltage Noise Spectral Density for V_{OUT} = 2.8 V, C_{OUT} = 220 nF

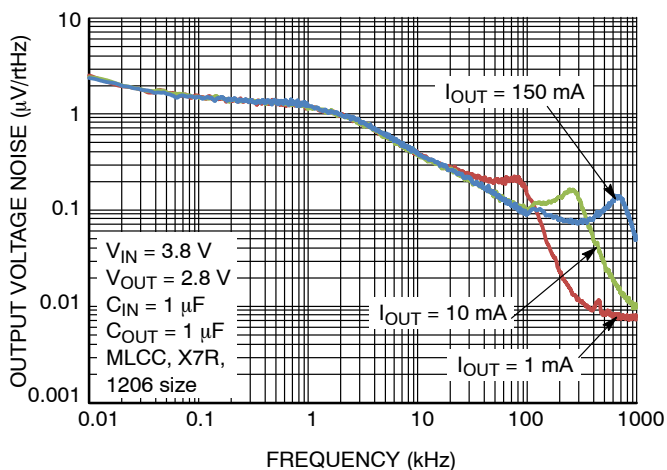

I _{OUT}	RMS Output Noise (µV)	
	10 Hz – 100 kHz	100 Hz – 100 kHz
1 mA	102.14	100.86
10 mA	93.03	91.59
150 mA	94.74	93.12

Figure 30. Output Voltage Noise Spectral Density for V_{OUT} = 2.8 V, C_{OUT} = 1 µF

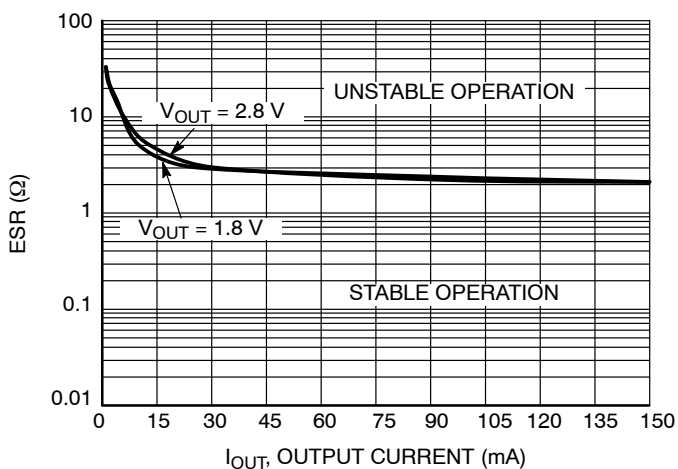

Figure 31. Output Capacitor ESR vs. Output Current

TYPICAL CHARACTERISTICS

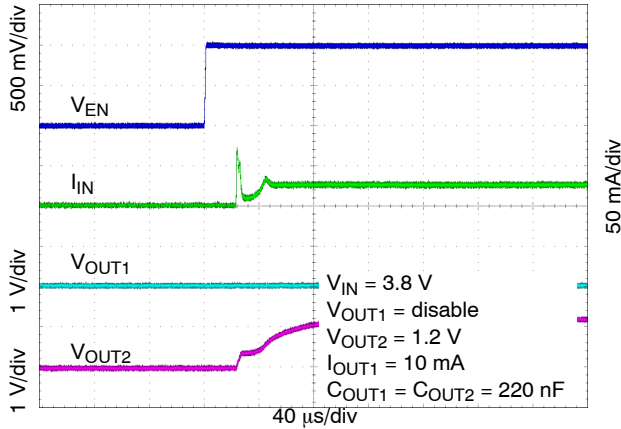

Figure 32. Enable Turn-on Response - VR1 = Off, VR2 = 10 mA

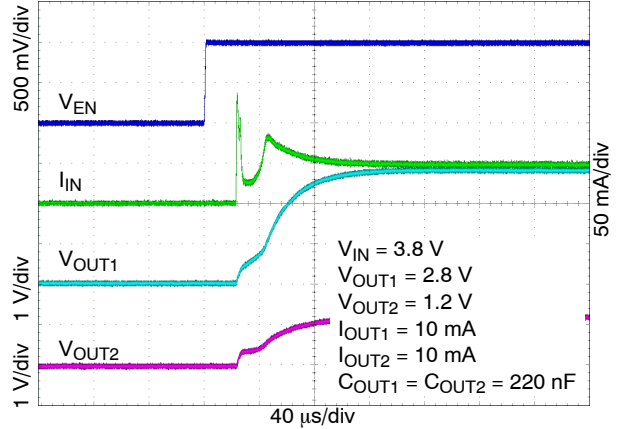

Figure 33. Enable Turn-on Response - VR1 = 10 mA, VR2 = 10 mA

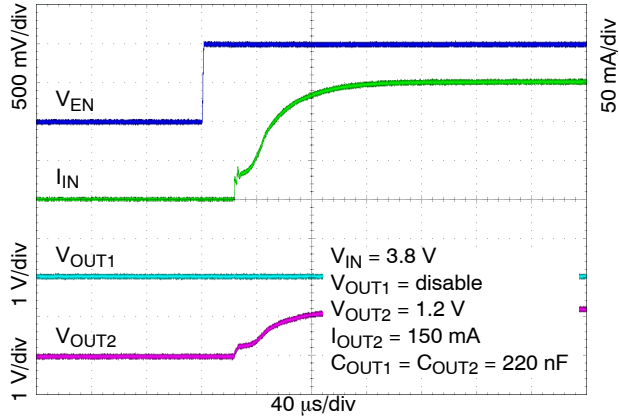

Figure 34. Enable Turn-on Response - VR1 = Off, VR2 = 150 mA

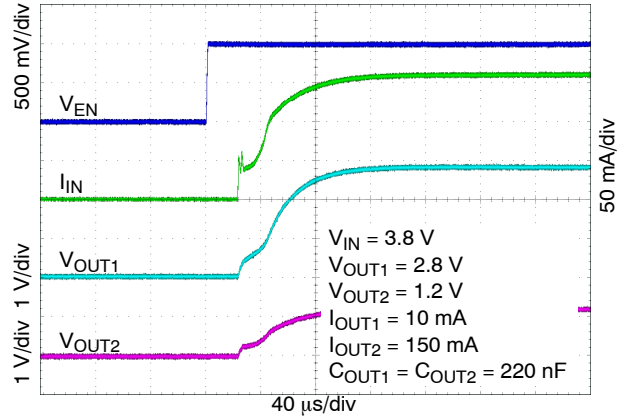

Figure 35. Enable Turn-on Response - VR1 = 10 mA, VR2 = 150 mA

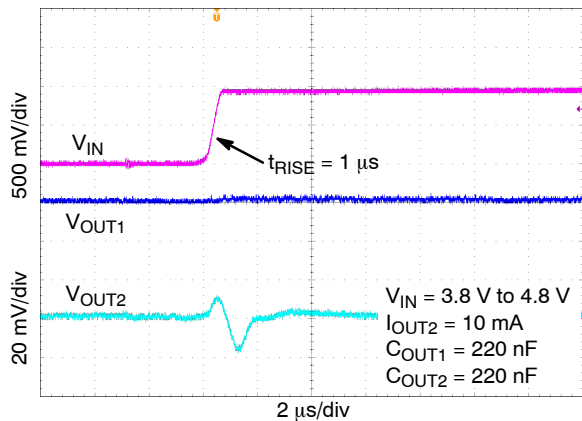

Figure 36. Line Transient Response - Rising Edge, $V_{EN1} = 0\text{ V}$, $V_{EN2} = V_{IN}$, $V_{OUT2} = 3.3\text{ V}$, $I_{OUT2} = 10\text{ mA}$

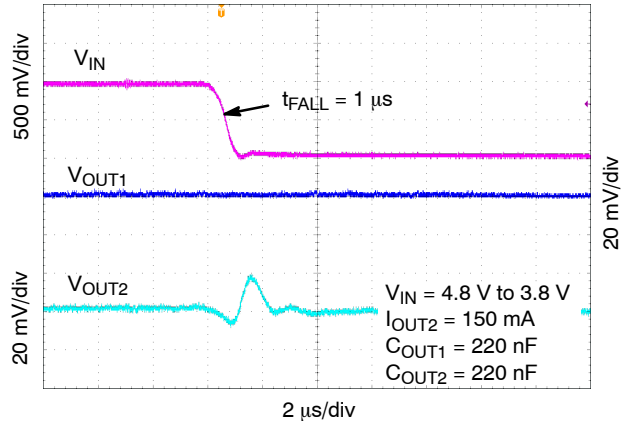

Figure 37. Line Transient Response - Falling Edge, $V_{EN1} = 0\text{ V}$, $V_{EN2} = V_{IN}$, $V_{OUT2} = 3.3\text{ V}$, $I_{OUT2} = 10\text{ mA}$

TYPICAL CHARACTERISTICS

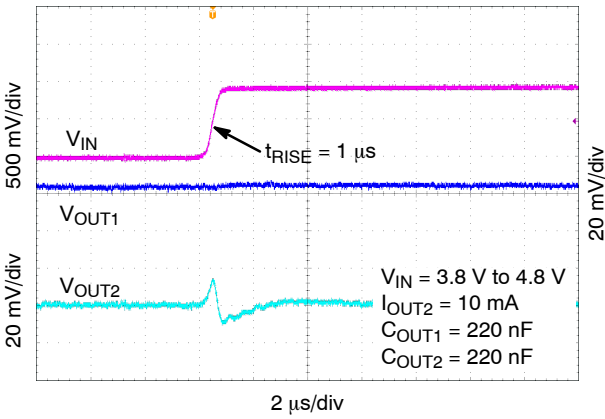

Figure 38. Line Transient Response – Rising Edge, $V_{EN1} = 0\text{ V}$, $V_{EN2} = V_{IN}$, $V_{OUT2} = 3.3\text{ V}$, $I_{OUT2} = 150\text{ mA}$

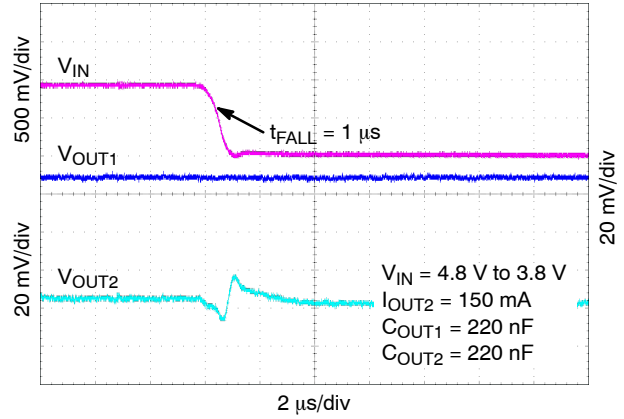

Figure 39. Line Transient Response – Falling Edge, $V_{EN1} = 0\text{ V}$, $V_{EN2} = V_{IN}$, $V_{OUT2} = 3.3\text{ V}$, $I_{OUT2} = 150\text{ mA}$

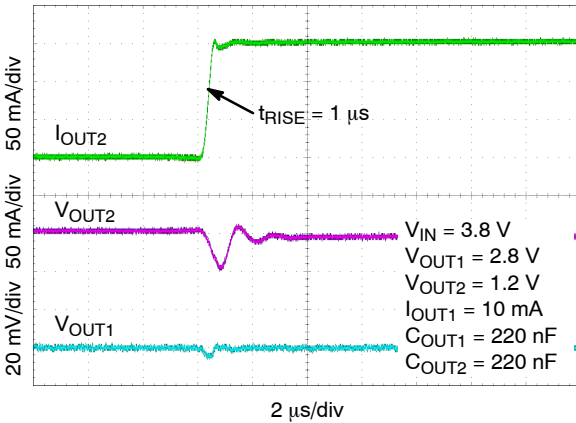

Figure 40. Load Transient Response – Rising Edge, $I_{OUT} = 1\text{ mA}$ to 150 mA

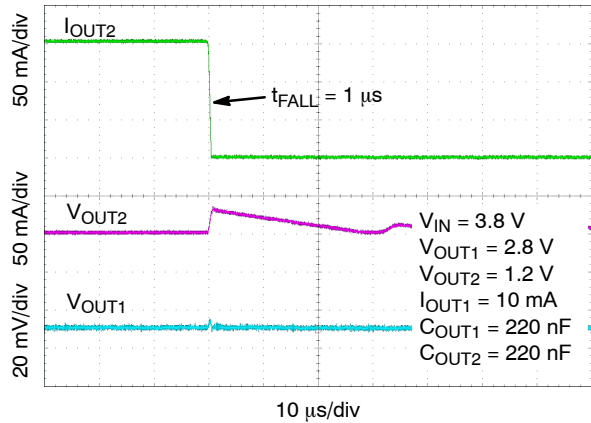

Figure 41. Load Transient Response – Falling Edge, $I_{OUT} = 150\text{ mA}$ to 1 mA

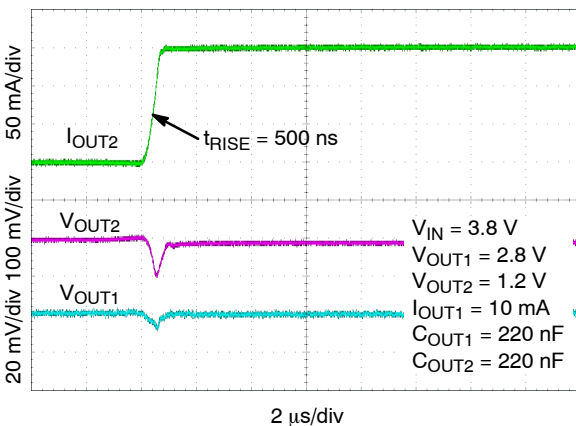

Figure 42. Load Transient Response – Rising Edge, $I_{OUT} = 0.1\text{ mA}$ to 150 mA

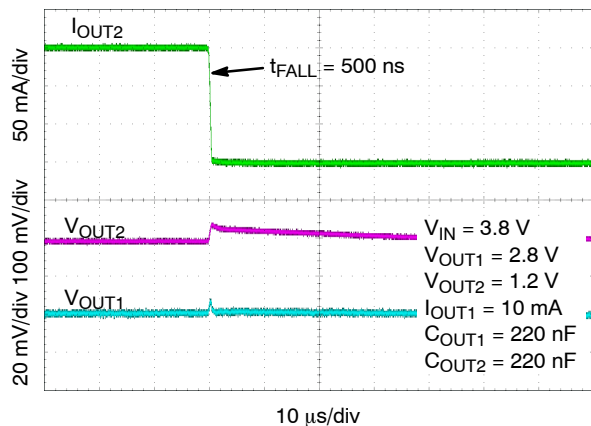

Figure 43. Load Transient Response – Falling Edge, $I_{OUT} = 150\text{ mA}$ to 0.1 mA

TYPICAL CHARACTERISTICS

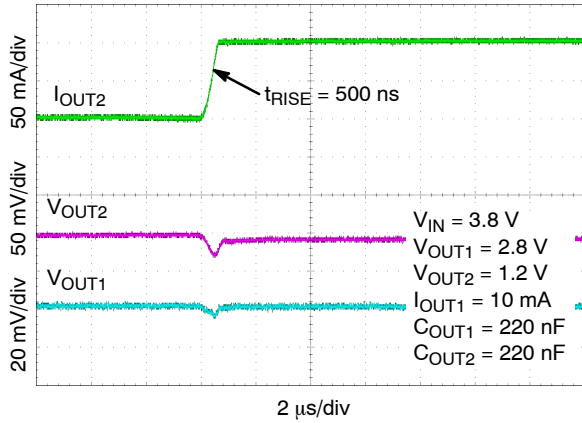

Figure 44. Load Transient Response – Rising Edge, $I_{OUT} = 50 \text{ mA}$ to 150 mA

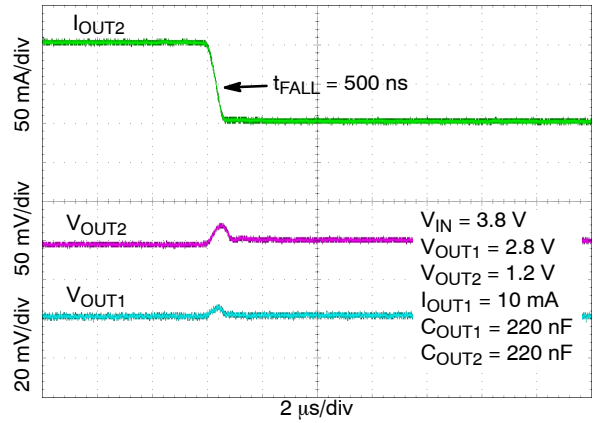

Figure 45. Load Transient Response – Falling Edge, $I_{OUT} = 150 \text{ mA}$ to 50 mA

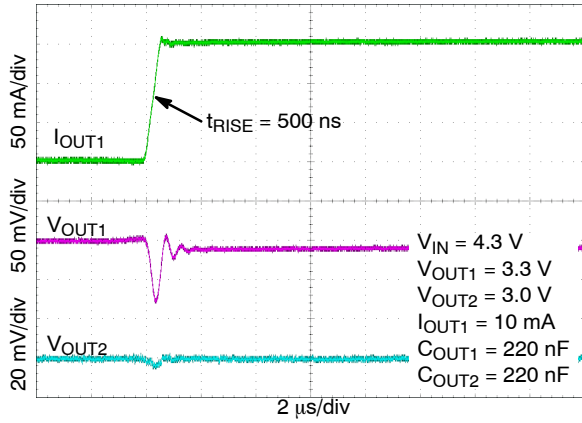

Figure 47. Load Transient Response – Rising Edge, $I_{OUT} = 1 \text{ mA}$ to 150 mA

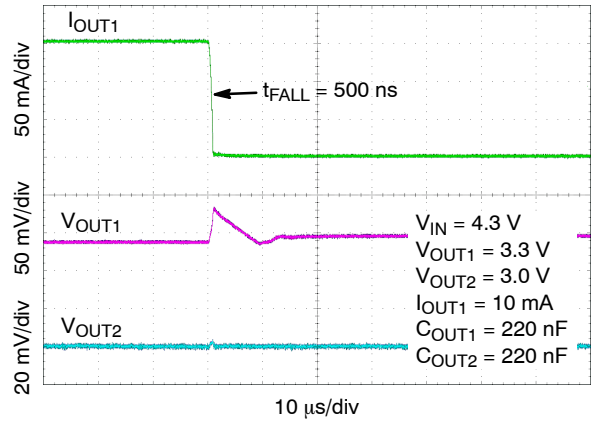

Figure 48. Load Transient Response – Falling Edge, $I_{OUT} = 150 \text{ mA}$ to 1 mA

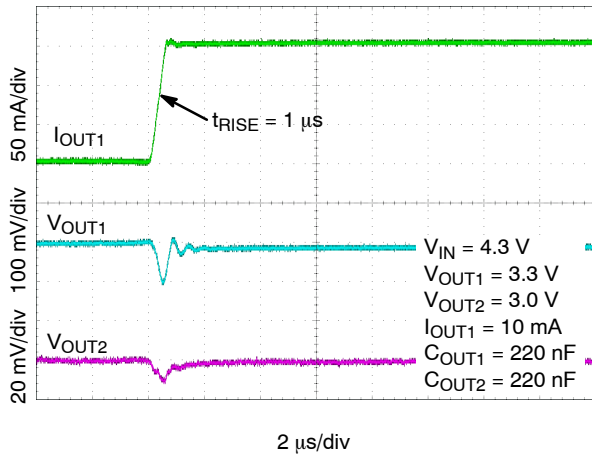

Figure 46. Load Transient Response – Rising Edge, $I_{OUT} = 0.1 \text{ mA}$ to 150 mA

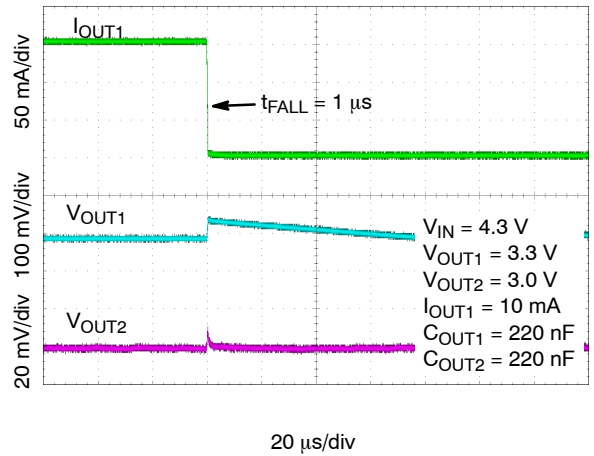

Figure 49. Load Transient Response – Falling Edge, $I_{OUT} = 150 \text{ mA}$ to 0.1 mA

TYPICAL CHARACTERISTICS

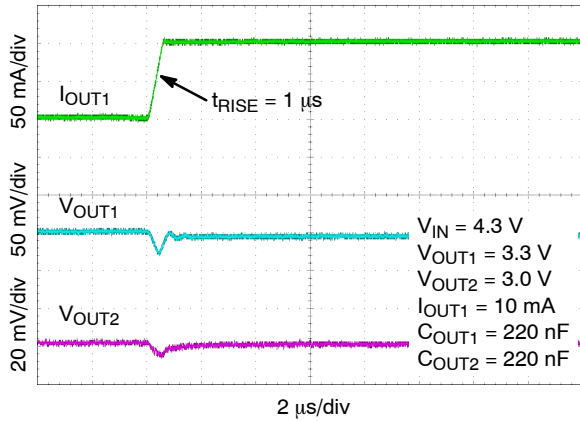

Figure 50. Load Transient Response – Rising Edge, $I_{OUT} = 50 \text{ mA}$ to 150 mA

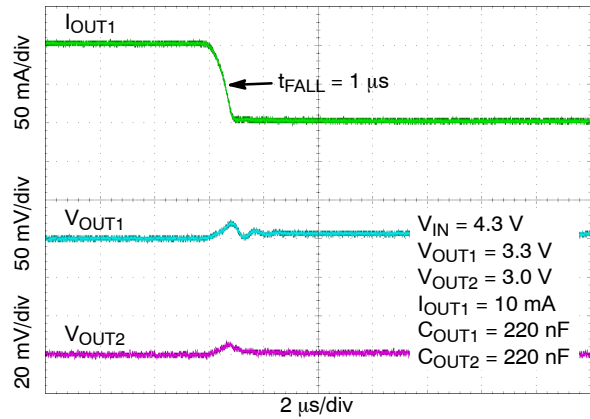

Figure 51. Load Transient Response – Falling Edge, $I_{OUT} = 150 \text{ mA}$ to 50 mA

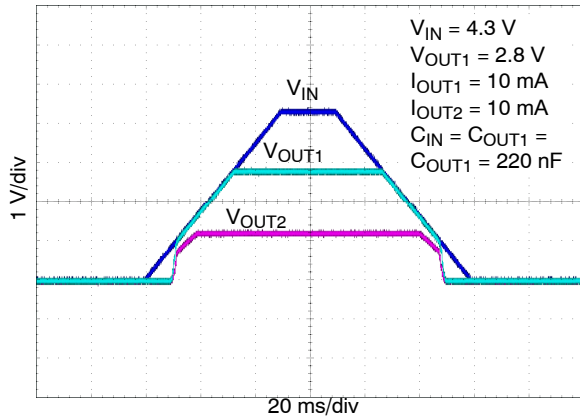

Figure 52. Turn-on/off – Slow Rising V_{IN}

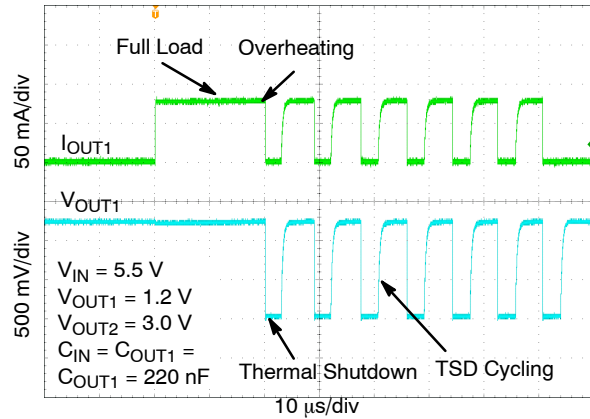

Figure 53. Short-Circuit and Thermal Shutdown

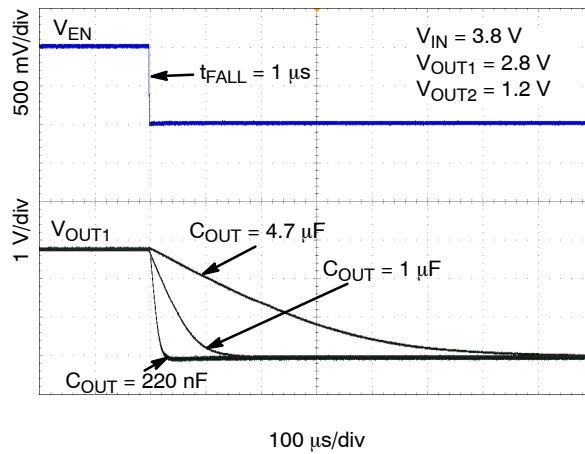

Figure 54. Enable Turn-off

APPLICATIONS INFORMATION

General

The NCV8152 is a dual output high performance 150 mA Low Dropout Linear Regulator. This device delivers very high PSRR (75 dB at 1 kHz) and excellent dynamic performance as load/line transients. In connection with low quiescent current this device is very suitable for various battery powered applications such as tablets, cellular phones, wireless and many others. Each output is fully protected in case of output overload, output short circuit condition and overheating, assuring a very robust design. The NCV8152 device is housed in XDFN-6 1.2 mm x 1.2 mm package which is useful for space constrained application.

Input Capacitor Selection (C_{IN})

It is recommended to connect at least a 0.22 μF Ceramic X5R or X7R capacitor as close as possible to the IN pin of the device. This capacitor will provide a low impedance path for unwanted AC signals or noise modulated onto constant input voltage. There is no requirement for the min. or max. ESR of the input capacitor but it is recommended to use ceramic capacitors for their low ESR and ESL. A good input capacitor will limit the influence of input trace inductance and source resistance during sudden load current changes. Larger input capacitor may be necessary if fast and large load transients are encountered in the application.

Output Decoupling (C_{OUT})

The NCV8152 requires an output capacitor for each output connected as close as possible to the output pin of the regulator. The recommended capacitor value is 0.22 μF and X7R or X5R dielectric due to its low capacitance variations over the specified temperature range. The NCV8152 is designed to remain stable with minimum effective capacitance of 0.15 μF to account for changes with temperature, DC bias and package size. Especially for small package size capacitors such as 0201 the effective capacitance drops rapidly with the applied DC bias.

There is no requirement for the minimum value of Equivalent Series Resistance (ESR) for the C_{OUT} but the maximum value of ESR should be less than 2 Ω. Larger output capacitors and lower ESR could improve the load transient response or high frequency PSRR. It is not recommended to use tantalum capacitors on the output due to their large ESR. The equivalent series resistance of tantalum capacitors is also strongly dependent on the temperature, increasing at low temperature.

Enable Operation

The NCV8152 uses the dedicated EN pin for each output channel. This feature allows driving outputs separately.

If the EN pin voltage is <0.4 V the device is guaranteed to be disabled. The pass transistor is turned-off so that there is virtually no current flow between the IN and OUT. The active discharge transistor is active so that the output voltage V_{OUT} is pulled to GND through a 50 Ω resistor. In the

disable state the device consumes as low as typ. 10 nA from the V_{IN}.

If the EN pin voltage >0.9 V the device is guaranteed to be enabled. The NCV8152 regulates the output voltage and the active discharge transistor is turned-off.

The both EN pin has internal pull-down current source with typ. value of 300 nA which assures that the device is turned-off when the EN pin is not connected. In the case where the EN function isn't required the EN should be tied directly to IN.

Output Current Limit

Output Current is internally limited within the IC to a typical 280 mA. The NCV8152 will source this amount of current measured with a voltage drops on the 90% of the nominal V_{OUT}. If the Output Voltage is directly shorted to ground (V_{OUT} = 0 V), the short circuit protection will limit the output current to 300 mA (typ). The current limit and short circuit protection will work properly over whole temperature range and also input voltage range. There is no limitation for the short circuit duration. This protection works separately for each channel. Short circuit on the one channel do not influence second channel which will work according to specification.

Thermal Shutdown

When the die temperature exceeds the Thermal Shutdown threshold (T_{SD} – 160°C typical), Thermal Shutdown event is detected and the affected channel is turn-off. Second channel still working. The channel which is overheated will remain in this state until the die temperature decreases below the Thermal Shutdown Reset threshold (T_{SDU} – 140°C typical). Once the device temperature falls below the 140°C the appropriate channel is enabled again. The thermal shutdown feature provides the protection from a catastrophic device failure due to accidental overheating. This protection is not intended to be used as a substitute for proper heat sinking. The long duration of the short circuit condition to some output channel could cause turn-off other output when heat sinking is not enough and temperature of the other output reach T_{SD} temperature.

Power Dissipation

As power dissipated in the NCV8152 increases, it might become necessary to provide some thermal relief. The maximum power dissipation supported by the device is dependent upon board design and layout. Mounting pad configuration on the PCB, the board material, and the ambient temperature affect the rate of junction temperature rise for the part. For reliable operation, junction temperature should be limited to +125°C.

The maximum power dissipation the NCV8152 can handle is given by:

$$P_{D(MAX)} = \frac{[125^{\circ}\text{C} - T_A]}{\theta_{JA}} \quad (\text{eq. 1})$$

NCV8152

The power dissipated by the NCV8152 for given application conditions can be calculated from the following equations:

$$P_D \approx V_{IN} \times I_{GND} + I_{OUT1}(V_{IN} - V_{OUT1}) + I_{OUT2}(V_{IN} - V_{OUT2}) \quad (\text{eq. 2})$$

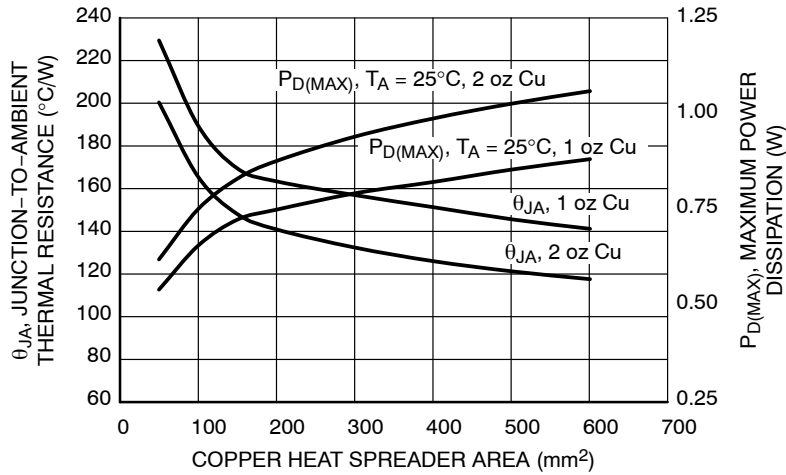

Figure 55. θ_{JA} vs. Copper Area (XDFN-6)

Reverse Current

The PMOS pass transistor has an inherent body diode which will be forward biased in the case that $V_{OUT} > V_{IN}$. Due to this fact in cases, where the extended reverse current condition can be anticipated the device may require additional external protection.

Power Supply Rejection Ratio

The NCV8152 features very good Power Supply Rejection ratio. If desired the PSRR at higher frequencies in the range 100 kHz – 10 MHz can be tuned by the selection of C_{OUT} capacitor and proper PCB layout.

Turn-On Time

The turn-on time is defined as the time period from EN assertion to the point in which V_{OUT} will reach 98% of its

nominal value. This time is dependent on various application conditions such as $V_{OUT(NOM)}$, C_{OUT} , T_A .

PCB Layout Recommendations

To obtain good transient performance and good regulation characteristics place input and output capacitors close to the device pins and make the PCB traces wide. In order to minimize the solution size, use 0402 capacitors. Larger copper area connected to the pins will also improve the device thermal resistance. The actual power dissipation can be calculated from the equation above (Equation 2). Expose pad should be tied the shortest path to the GND pin.

ORDERING INFORMATION

Device	Voltage Option (OUT1/OUT2)	Marking	Marking Rotation	Package	Shipping [†]
NCV8152MX180150TCG	1.8 V/1.5 V	AN	0°	XDFN-6 (Pb-Free)	3000 / Tape & Reel
NCV8152MX180180TCG	1.8 V/1.8 V	AJ	0°		
NCV8152MX180280TCG	1.8 V/2.8 V	5	180°		
NCV8152MX280180TCG	2.8 V/1.8 V	6	270°		
NCV8152MX300180TCG	3.0 V/1.8 V	L	90°		
NCV8152MX330180TCG	3.3 V/1.8 V	R	90°		

[†]For information on tape and reel specifications, including part orientation and tape sizes, please refer to our Tape and Reel Packaging Specifications Brochure, BRD8011/D.

MECHANICAL CASE OUTLINE

PACKAGE DIMENSIONS

ON Semiconductor®



SCALE 4:1

XDFN6 1.20x1.20, 0.40P
CASE 711AT
ISSUE C

DATE 04 DEC 2015

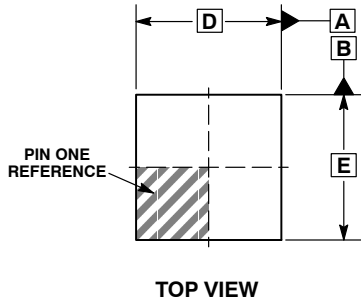

TOP VIEW

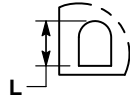

DETAIL A
OPTIONAL
CONSTRUCTION

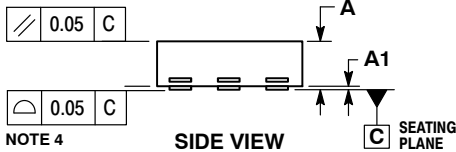

SIDE VIEW

NOTE 4

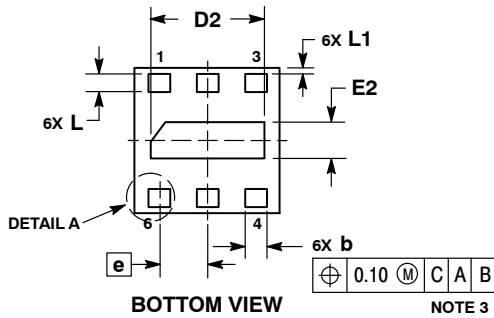

BOTTOM VIEW

NOTE 3

NOTES:

1. DIMENSIONING AND TOLERANCING PER ASME Y14.5M, 1994.
2. CONTROLLING DIMENSION: MILLIMETERS.
3. DIMENSION b APPLIES TO THE PLATED TERMINALS.
4. COPLANARITY APPLIES TO THE PAD AS WELL AS THE TERMINALS.

DIM	MILLIMETERS		
	MIN	TYP	MAX
A	0.30	0.37	0.45
A1	0.00	0.03	0.05
b	0.13	0.18	0.23
D	1.15	1.20	1.25
D2	0.84	0.94	1.04
E	1.15	1.20	1.25
E2	0.20	0.30	0.40
e	0.40 BSC		
L	0.15	0.20	0.25
L1	0.00	0.05	0.10

GENERIC MARKING DIAGRAM*



XX = Specific Device Code
M = Date Code

*This information is generic. Please refer to device data sheet for actual part marking. Pb-Free indicator, "G" or microdot "▪", may or may not be present.

RECOMMENDED MOUNTING FOOTPRINT*

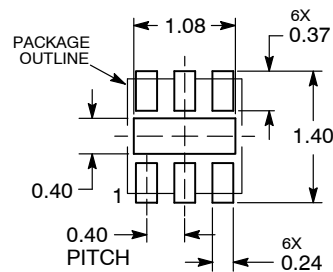

DIMENSIONS: MILLIMETERS

*For additional information on our Pb-Free strategy and soldering details, please download the ON Semiconductor Soldering and Mounting Techniques Reference Manual, SOLDERRM/D.

DOCUMENT NUMBER:	98AON76141F	Electronic versions are uncontrolled except when accessed directly from the Document Repository. Printed versions are uncontrolled except when stamped "CONTROLLED COPY" in red.
DESCRIPTION:	XDFN6, 1.20 X 1.20, 0.40P	PAGE 1 OF 1

ON Semiconductor and are trademarks of Semiconductor Components Industries, LLC dba ON Semiconductor or its subsidiaries in the United States and/or other countries. ON Semiconductor reserves the right to make changes without further notice to any products herein. ON Semiconductor makes no warranty, representation or guarantee regarding the suitability of its products for any particular purpose, nor does ON Semiconductor assume any liability arising out of the application or use of any product or circuit, and specifically disclaims any and all liability, including without limitation special, consequential or incidental damages. ON Semiconductor does not convey any license under its patent rights nor the rights of others.

ON Semiconductor and  are trademarks of Semiconductor Components Industries, LLC dba ON Semiconductor or its subsidiaries in the United States and/or other countries. ON Semiconductor owns the rights to a number of patents, trademarks, copyrights, trade secrets, and other intellectual property. A listing of ON Semiconductor's product/patent coverage may be accessed at www.onsemi.com/site/pdf/Patent-Marking.pdf. ON Semiconductor reserves the right to make changes without further notice to any products herein. ON Semiconductor makes no warranty, representation or guarantee regarding the suitability of its products for any particular purpose, nor does ON Semiconductor assume any liability arising out of the application or use of any product or circuit, and specifically disclaims any and all liability, including without limitation special, consequential or incidental damages. Buyer is responsible for its products and applications using ON Semiconductor products, including compliance with all laws, regulations and safety requirements or standards, regardless of any support or applications information provided by ON Semiconductor. "Typical" parameters which may be provided in ON Semiconductor data sheets and/or specifications can and do vary in different applications and actual performance may vary over time. All operating parameters, including "Typicals" must be validated for each customer application by customer's technical experts. ON Semiconductor does not convey any license under its patent rights nor the rights of others. ON Semiconductor products are not designed, intended, or authorized for use as a critical component in life support systems or any FDA Class 3 medical devices or medical devices with a same or similar classification in a foreign jurisdiction or any devices intended for implantation in the human body. Should Buyer purchase or use ON Semiconductor products for any such unintended or unauthorized application, Buyer shall indemnify and hold ON Semiconductor and its officers, employees, subsidiaries, affiliates, and distributors harmless against all claims, costs, damages, and expenses, and reasonable attorney fees arising out of, directly or indirectly, any claim of personal injury or death associated with such unintended or unauthorized use, even if such claim alleges that ON Semiconductor was negligent regarding the design or manufacture of the part. ON Semiconductor is an Equal Opportunity/Affirmative Action Employer. This literature is subject to all applicable copyright laws and is not for resale in any manner.

PUBLICATION ORDERING INFORMATION

LITERATURE FULFILLMENT:

Email Requests to: orderlit@onsemi.com

ON Semiconductor Website: www.onsemi.com

TECHNICAL SUPPORT

North American Technical Support:
Voice Mail: 1 800-282-9855 Toll Free USA/Canada
Phone: 011 421 33 790 2910

Europe, Middle East and Africa Technical Support:

Phone: 00421 33 790 2910

For additional information, please contact your local Sales Representative