

# NCS2200, NCS2200A, NCS2202, NCS2202A

## Comparators, 0.85 V to 6 V, 10 $\mu$ A, 1 $\mu$ s, Rail-to-Rail, Open Drain and Push-Pull Outputs

The NCS2200 series is an industry first sub-one volt, low power comparator family. These devices consume only 10  $\mu$ A of supply current. They are guaranteed to operate at a low voltage of 0.85 V which allows them to be used in systems that require less than 1.0 V and are fully operational up to 6.0 V which makes them convenient for use in both 3.0 V and 5.0 V systems. Additional features include no output phase inversion with overdriven inputs, internal hysteresis, which allows for clean output switching, and rail-to-rail input and output performance. The NCS2200 Series is available in complementary push-pull and open drain outputs and a variety of packages. There are two industry standard pinouts for SOT-23-5 and SC70-5 packages. The NCS2200 is also available in the tiny DFN 2x2.2 package. The NCS2200A and NCS2202A are available in a UDFN 1.2x1.0 package. See package option information in Table 1 on page 2 for more information.

### Features

- Operating Voltage of 0.85 V to 6.0 V
- Rail-to-Rail Input/Output Performance
- Low Supply Current of 10  $\mu$ A
- No Phase Inversion with Overdriven Input Signals
- Glitchless Transitioning in or out of Tri-State Mode
- Complementary or Open Drain Output Configuration
- Internal Hysteresis
- Propagation Delay of 1.0  $\mu$ s for NCS2200
- NCV Prefix for Automotive and Other Applications Requiring Unique Site and Control Change Requirements; AEC-Q100 Qualified and PPAP Capable
- These Devices are Pb-Free and are RoHS Compliant

### Typical Applications

- Single Cell NiCd/NiMH Battery Powered Applications
- Automotive

### End Products

- Cellphones, Smart Phones
- Alarm and Security Systems
- Personal Digital Assistants



ON Semiconductor®

[www.onsemi.com](http://www.onsemi.com)



SOT-23-5 (TSOP-5)  
SN SUFFIX  
CASE 483

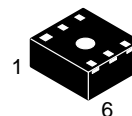

DFN 2x2.2  
SQL SUFFIX  
CASE 488



SC70-5  
SQ SUFFIX  
CASE 419A

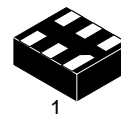

UDFN 1.2x1.0  
MU SUFFIX  
CASE 517AA

### ORDERING INFORMATION

See detailed ordering and shipping information in the package dimensions section on page 13 of this data sheet.

### DEVICE MARKING INFORMATION

See general marking information in the device marking section on page 14 of this data sheet.

# NCS2200, NCS2200A, NCS2202, NCS2202A

**Table 1. COMPARATOR SELECTOR GUIDE**

| Output Type             | Package         | Pinout Style | Automotive    | Device         |
|-------------------------|-----------------|--------------|---------------|----------------|
| Complementary Push-Pull | UDFN, 1.2x1.0   | N/A          | No            | NCS2200AMUT1G  |
|                         |                 | N/A          | Yes           | NCV2200AMUTBG* |
|                         | SOT-23-5        | 1            | No            | NCS2200SN1T1G  |
|                         |                 |              | Yes           | NCV2200SN1T1G* |
|                         |                 | 2            | No            | NCS2200SN2T1G  |
|                         |                 |              | Yes           | NCV2200SN2T1G* |
|                         | SC70-5          | 2            | No            | NCS2200SQ2T2G  |
|                         |                 |              | Yes           | NCV2200SQ2T2G* |
| DFN, 2x2.2              | N/A             | No           | NCS2200SQLT1G |                |
| Open Drain              | SOT-23-5        | 1            | No            | NCS2202SN1T1G  |
|                         |                 | 2            | No            | NCS2202SN2T1G  |
|                         |                 |              | Yes           | NCV2202SN2T1G* |
|                         | SC70-5          | 1            | No            | NCS2202SQ1T2G  |
|                         |                 | 2            | No            | NCS2202SQ2T2G  |
|                         | UDFN, 1.2 x 1.0 | N/A          | No            | NCS2202AMUTBG  |

\*NCV Prefix for Automotive and Other Applications Requiring Unique Site and Control Change Requirements; AEC-Q100 Qualified and PPA Capable.

### PIN CONNECTIONS

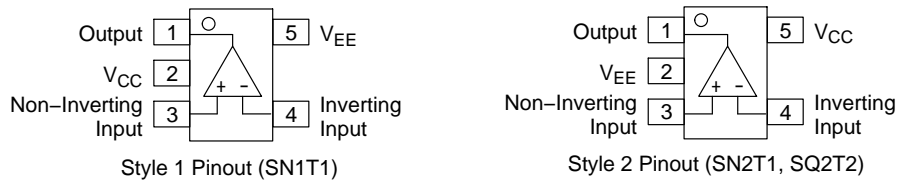

**Figure 1. SOT-23-5 (NCS2200, NCS2202), SC70-5 (NCS2200, NCS2202)**

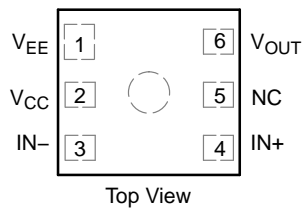

**Figure 2. DFN 2x2.2 (NCS2200)**

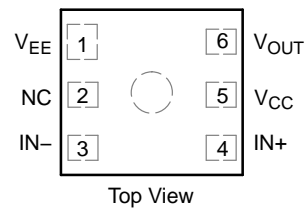

**Figure 3. UDFN 1.2x1.0 (NCS2200A/NCS2202A)**

# NCS2200, NCS2200A, NCS2202, NCS2202A

## MAXIMUM RATINGS

| Rating  | Symbol          | Value                      | Unit |
|---|-----------------|----------------------------|------|
| Supply Voltage Range ( $V_{CC}$ to $V_{EE}$ )   | $V_S$           | 6.0                        | V    |
| Non-inverting/Inverting Input to $V_{EE}$   | $V_{CM}$        | -0.2 to ( $V_{CC} + 0.2$ ) | V    |
| Operating Junction Temperature  | $T_J$           | 150                        | °C   |
| Operating Ambient Temperature Range<br>NCS2200, NCS2202, NCS2200A, NCS2202A<br>NCV2200, NCV2202, NCV2200A | $T_A$           | -40 to +105<br>-40 to +125 | °C   |
| Storage Temperature Range   | $T_{stg}$       | -65 to +150                | °C   |
| Output Short Circuit Duration Time (Note 1)   | $t_s$           | Indefinite                 | s    |
| ESD Tolerance (Note 2)  | ESD             |                            | V    |
| NCS2200   |                 |                            |      |
| Human Body Model  | HBM             | 2000                       |      |
| Machine Model   | MM              | 200                        |      |
| NCS2202   |                 |                            |      |
| Human Body Model  | HBM             | 2000                       |      |
| Machine Model   | MM              | 200                        |      |
| NCS2200A  |                 |                            |      |
| Human Body Model  | HBM             | 1900                       |      |
| Machine Model   | MM              | 200                        |      |
| NCS2202A  |                 |                            |      |
| Human Body Model – all pins except output   | HBM             | 1500                       |      |
| Human Body Model – output pin   | HBM             | 500                        |      |
| Machine Model   | MM              | 150                        |      |
| Thermal Resistance, Junction-to-Ambient   | $R_{\theta JA}$ |                            | °C/W |
| TSOP-5  |                 | 238                        |      |
| DFN (Note 3)  |                 | 215                        |      |
| SC70-5  |                 | 283                        |      |
| UDFN  |                 | 350                        |      |

Stresses exceeding those listed in the Maximum Ratings table may damage the device. If any of these limits are exceeded, device functionality should not be assumed, damage may occur and reliability may be affected.

1. The maximum package power dissipation limit must not be exceeded.

$$P_D = \frac{T_J(\max) - T_A}{R_{\theta JA}}$$

2. ESD data available upon request.

3. For more information, refer to application note, AND8080/D.

# NCS2200, NCS2200A, NCS2202, NCS2202A

**NCS2200 ELECTRICAL CHARACTERISTICS** (For all values  $V_{CC} = 0.85\text{ V}$  to  $6.0\text{ V}$ ,  $V_{EE} = 0\text{ V}$ ,  $T_A = 25^\circ\text{C}$ , unless otherwise noted.) (Note 4)

| Symbol     | Parameter                                | Conditions  | Min                                | Typ                  | Max                                | Unit          |
|------------|--|---|------------------------------------|----------------------|------------------------------------|---------------|
| $V_{HYS}$  | Input Hysteresis                         | $T_A = 25^\circ\text{C}$  | 2.0                                | 8.0                  | 20                                 | mV            |
| $V_{IO}$   | Input Offset Voltage                     | $V_{CC} = 0.85\text{ V}$<br>$T_A = 25^\circ\text{C}$<br>$T_A = T_{Low}$ to $T_{High}$ (Note 5)                                | -10<br>-12                         | 0.5<br>-             | +10<br>+12                         | mV            |
|            |  | $V_{CC} = 3.0\text{ V}$<br>$T_A = 25^\circ\text{C}$<br>$T_A = T_{Low}$ to $T_{High}$  | -6.0<br>-8.0                       | 0.5<br>-             | +6.0<br>+8.0                       |               |
|            |  | $V_{CC} = 6.0\text{ V}$<br>$T_A = 25^\circ\text{C}$<br>$T_A = T_{Low}$ to $T_{High}$  | -5.0<br>-7.0                       | 0.5<br>-             | +5.0<br>+7.0                       |               |
| $V_{CM}$   | Common Mode Voltage Range                |   | -                                  | $V_{EE}$ to $V_{CC}$ | -                                  | V             |
| $I_{LEAK}$ | Output Leakage Current                   | $V_{CC} = 6.0\text{ V}$   | -                                  | 3.3                  | -                                  | nA            |
| $I_{SC}$   | Output Short-Circuit Sourcing or Sinking | $V_{out} = \text{GND}$  | -                                  | 70                   | -                                  | mA            |
| CMRR       | Common Mode Rejection Ratio              | $V_{CM} = V_{CC}$   | 53                                 | 65                   | -                                  | dB            |
| $I_{IB}$   | Input Bias Current                       |   | -                                  | 1.0                  | -                                  | pA            |
| PSRR       | Power Supply Rejection Ratio             | $\Delta V_S = 2.575\text{ V}$   | 45                                 | 55                   | -                                  | dB            |
| $I_{CC}$   | Supply Current                           | $V_{CC} = 0.85\text{ V}$<br>$T_A = 25^\circ\text{C}$<br>$T_A = T_{Low}$ to $T_{High}$ (Note 5)                                | -                                  | 10<br>-              | 15<br>17                           | $\mu\text{A}$ |
|            |  | $V_{CC} = 3.0\text{ V}$<br>$T_A = 25^\circ\text{C}$<br>$T_A = T_{Low}$ to $T_{High}$  | -                                  | 10<br>-              | 15<br>17                           |               |
|            |  | $V_{CC} = 6.0\text{ V}$<br>$T_A = 25^\circ\text{C}$<br>$T_A = T_{Low}$ to $T_{High}$  | -                                  | 10<br>-              | 15<br>17                           |               |
| $V_{OH}$   | Output Voltage High                      | $V_{CC} = 0.85\text{ V}$ , $I_{source} = 0.5\text{ mA}$<br>$T_A = 25^\circ\text{C}$<br>$T_A = T_{Low}$ to $T_{High}$ (Note 5) | $V_{CC} - 0.2$<br>$V_{CC} - 0.225$ | $V_{CC} - 0.10$<br>- | -                                  | V             |
|            |  | $V_{CC} = 3.0\text{ V}$ , $I_{source} = 3.0\text{ mA}$<br>$T_A = 25^\circ\text{C}$<br>$T_A = T_{Low}$ to $T_{High}$           | $V_{CC} - 0.2$<br>$V_{CC} - 0.25$  | $V_{CC} - 0.12$<br>- | -                                  |               |
|            |  | $V_{CC} = 6.0\text{ V}$ , $I_{source} = 5.0\text{ mA}$<br>$T_A = 25^\circ\text{C}$<br>$T_A = T_{Low}$ to $T_{High}$           | $V_{CC} - 0.2$<br>$V_{CC} - 0.25$  | $V_{CC} - 0.12$<br>- | -                                  |               |
| $V_{OL}$   | Output Voltage Low                       | $V_{CC} = 0.85\text{ V}$ , $I_{sink} = 0.5\text{ mA}$<br>$T_A = 25^\circ\text{C}$<br>$T_A = T_{Low}$ to $T_{High}$ (Note 5)   | -                                  | $V_{EE} + 0.10$<br>- | $V_{EE} + 0.2$<br>$V_{EE} + 0.225$ | V             |
|            |  | $V_{CC} = 3.0\text{ V}$ , $I_{sink} = 3.0\text{ mA}$<br>$T_A = 25^\circ\text{C}$<br>$T_A = T_{Low}$ to $T_{High}$             | -                                  | $V_{EE} + 0.12$<br>- | $V_{EE} + 0.2$<br>$V_{EE} + 0.25$  |               |
|            |  | $V_{CC} = 6.0\text{ V}$ , $I_{sink} = 5.0\text{ mA}$<br>$T_A = 25^\circ\text{C}$<br>$T_A = T_{Low}$ to $T_{High}$             | -                                  | $V_{EE} + 0.12$<br>- | $V_{EE} + 0.2$<br>$V_{EE} + 0.25$  |               |
| $t_{PHL}$  | Propagation Delay, High-to-Low           | 20 mV Overdrive, $C_L = 15\text{ pF}$   | -                                  | 1080                 | -                                  | ns            |
| $t_{PLH}$  | Propagation Delay, Low-to-High           | 20 mV Overdrive, $C_L = 15\text{ pF}$   | -                                  | 900                  | -                                  | ns            |
| $t_{FALL}$ | Output Fall Time                         | $V_{CC} = 6.0\text{ V}$ , $C_L = 50\text{ pF}$  | -                                  | 13                   | -                                  | ns            |
| $t_{RISE}$ | Output Rise Time                         | $V_{CC} = 6.0\text{ V}$ , $C_L = 50\text{ pF}$  | -                                  | 8.0                  | -                                  | ns            |
| $t_{PU}$   | Powerup Time                             |   | -                                  | 35                   | -                                  | $\mu\text{s}$ |

Product parametric performance is indicated in the Electrical Characteristics for the listed test conditions, unless otherwise noted. Product performance may not be indicated by the Electrical Characteristics if operated under different conditions.

4. The limits over the extended temperature range are guaranteed by design only.

5. NCS2200:  $T_{Low} = -40^\circ\text{C}$ ,  $T_{High} = +105^\circ\text{C}$ ; NCV2200:  $T_{Low} = -40^\circ\text{C}$ ,  $T_{High} = +125^\circ\text{C}$

# NCS2200, NCS2200A, NCS2202, NCS2202A

**NCS2202 ELECTRICAL CHARACTERISTICS** (For all values  $V_{CC} = 0.85\text{ V}$  to  $6.0\text{ V}$ ,  $V_{EE} = 0\text{ V}$ ,  $T_A = 25^\circ\text{C}$ ,  $R_{pullup} = 10\text{ k}\Omega$ , unless otherwise noted.) (Note 6)

| Symbol     | Parameter                                | Conditions  | Min          | Typ                  | Max                                | Unit          |
|------------|--|---|--------------|----------------------|------------------------------------|---------------|
| $V_{HYS}$  | Input Hysteresis                         | $T_A = 25^\circ\text{C}$  | 2.0          | 8.0                  | 20                                 | mV            |
| $V_{IO}$   | Input Offset Voltage                     | $V_{CC} = 0.85\text{ V}$<br>$T_A = 25^\circ\text{C}$<br>$T_A = T_{Low}$ to $T_{High}$ (Note 7)                              | -10<br>-12   | 0.5<br>-             | +10<br>+12                         | mV            |
|            |  | $V_{CC} = 3.0\text{ V}$<br>$T_A = 25^\circ\text{C}$<br>$T_A = T_{Low}$ to $T_{High}$  | -6.0<br>-8.0 | 0.5<br>-             | +6.0<br>+8.0                       |               |
|            |  | $V_{CC} = 6.0\text{ V}$<br>$T_A = 25^\circ\text{C}$<br>$T_A = T_{Low}$ to $T_{High}$  | -5.0<br>-7.0 | 0.5<br>-             | +5.0<br>+7.0                       |               |
| $V_{CM}$   | Common Mode Voltage Range                |   | -            | $V_{EE}$ to $V_{CC}$ | -                                  | V             |
| $I_{LEAK}$ | Output Leakage Current                   | $V_{CC} = 6.0\text{ V}$   | -            | 3.3                  | -                                  | nA            |
| $I_{SC}$   | Output Short-Circuit Sourcing or Sinking | $V_{out} = \text{GND}$  | -            | 70                   | -                                  | mA            |
| CMRR       | Common Mode Rejection Ratio              | $V_{CM} = V_{CC}$   | 53           | 65                   | -                                  | dB            |
| $I_{IB}$   | Input Bias Current                       |   | -            | 1.0                  | -                                  | pA            |
| PSRR       | Power Supply Rejection Ratio             | $\Delta V_S = 2.575\text{ V}$   | 45           | 55                   | -                                  | dB            |
| $I_{CC}$   | Supply Current                           | $V_{CC} = 0.85\text{ V}$<br>$T_A = 25^\circ\text{C}$<br>$T_A = T_{Low}$ to $T_{High}$ (Note 7)                              | -            | 10<br>-              | 15<br>17                           | $\mu\text{A}$ |
|            |  | $V_{CC} = 3.0\text{ V}$<br>$T_A = 25^\circ\text{C}$<br>$T_A = T_{Low}$ to $T_{High}$  | -            | 10<br>-              | 15<br>17                           |               |
|            |  | $V_{CC} = 6.0\text{ V}$<br>$T_A = 25^\circ\text{C}$<br>$T_A = T_{Low}$ to $T_{High}$  | -            | 10<br>-              | 15<br>17                           |               |
| $V_{OL}$   | Output Voltage Low                       | $V_{CC} = 0.85\text{ V}$ , $I_{sink} = 0.5\text{ mA}$<br>$T_A = 25^\circ\text{C}$<br>$T_A = T_{Low}$ to $T_{High}$ (Note 7) | -            | $V_{EE} + 0.10$<br>- | $V_{EE} + 0.2$<br>$V_{EE} + 0.225$ | V             |
|            |  | $V_{CC} = 3.0\text{ V}$ , $I_{sink} = 3.0\text{ mA}$<br>$T_A = 25^\circ\text{C}$<br>$T_A = T_{Low}$ to $T_{High}$           | -            | $V_{EE} + 0.12$<br>- | $V_{EE} + 0.2$<br>$V_{EE} + 0.25$  |               |
|            |  | $V_{CC} = 6.0\text{ V}$ , $I_{sink} = 5.0\text{ mA}$<br>$T_A = 25^\circ\text{C}$<br>$T_A = T_{Low}$ to $T_{High}$           | -            | $V_{EE} + 0.12$<br>- | $V_{EE} + 0.2$<br>$V_{EE} + 0.25$  |               |
| $t_{PHL}$  | Propagation Delay, High-to-Low           | 20 mV Overdrive, $C_L = 15\text{ pF}$   | -            | 1000                 | -                                  | ns            |
| $t_{PLH}$  | Propagation Delay, Low-to-High           | 20 mV Overdrive, $C_L = 15\text{ pF}$   | -            | 800                  | -                                  | ns            |
| $t_{FALL}$ | Output Fall Time                         | $V_{CC} = 6.0\text{ V}$ , $C_L = 50\text{ pF}$  | -            | 6.0                  | -                                  | ns            |
| $t_{RISE}$ | Output Rise Time                         | $V_{CC} = 6.0\text{ V}$ , $C_L = 50\text{ pF}$  | -            | 260                  | -                                  | ns            |
| $t_{PU}$   | Powerup Time                             |   | -            | 35                   | -                                  | $\mu\text{s}$ |

Product parametric performance is indicated in the Electrical Characteristics for the listed test conditions, unless otherwise noted. Product performance may not be indicated by the Electrical Characteristics if operated under different conditions.

6. The limits over the extended temperature range are guaranteed by design only.

7. NCS2202:  $T_{Low} = -40^\circ\text{C}$ ,  $T_{High} = +105^\circ\text{C}$ ; NCV2202:  $T_{Low} = -40^\circ\text{C}$ ,  $T_{High} = +125^\circ\text{C}$

# NCS2200, NCS2200A, NCS2202, NCS2202A

**NCS2200A ELECTRICAL CHARACTERISTICS** (For all values  $V_{CC} = 0.85\text{ V}$  to  $6.0\text{ V}$ ,  $V_{EE} = 0\text{ V}$ ,  $T_A = 25^\circ\text{C}$ , unless otherwise noted.) (Note 8)

| Symbol     | Parameter                                | Conditions   | Min                                 | Typ                  | Max                                 | Unit          |
|------------|--|--|-------------------------------------|----------------------|-------------------------------------|---------------|
| $V_{HYS}$  | Input Hysteresis                         | $T_A = 25^\circ\text{C}$   | 2.0                                 | 4.5                  | 20                                  | mV            |
| $V_{IO}$   | Input Offset Voltage                     | $V_{CC} = 0.85\text{ V}$<br>$T_A = 25^\circ\text{C}$<br>$T_A = T_{LOW}$ to $T_{HIGH}$                                | -10<br>-12                          | 0.5<br>-             | +10<br>+12                          | mV            |
|            |  | $V_{CC} = 3.0\text{ V}$<br>$T_A = 25^\circ\text{C}$<br>$T_A = T_{LOW}$ to $T_{HIGH}$                                 | -6.0<br>-8.0                        | 0.5<br>-             | +6.0<br>+8.0                        |               |
|            |  | $V_{CC} = 6.0\text{ V}$<br>$T_A = 25^\circ\text{C}$<br>$T_A = T_{LOW}$ to $T_{HIGH}$                                 | -5.0<br>-7.0                        | 0.5<br>-             | +5.0<br>+7.0                        |               |
| $V_{CM}$   | Common Mode Voltage Range                |  | -                                   | $V_{EE}$ to $V_{CC}$ | -                                   | V             |
| $I_{SC}$   | Output Short-Circuit Sourcing or Sinking | $V_{out} = \text{GND}$   | -                                   | 60                   | -                                   | mA            |
| CMRR       | Common Mode Rejection Ratio              | $V_{CM} = V_{CC}$  | 53                                  | 70                   | -                                   | dB            |
| $I_{IB}$   | Input Bias Current                       |  | -                                   | 1.0                  | -                                   | pA            |
| PSRR       | Power Supply Rejection Ratio             | $\Delta V_S = 2.575\text{ V}$  | 45                                  | 80                   | -                                   | dB            |
| $I_{CC}$   | Supply Current                           | $V_{CC} = 0.85\text{ V}$<br>$T_A = 25^\circ\text{C}$<br>$T_A = T_{LOW}$ to $T_{HIGH}$                                | -                                   | 7.5<br>-             | 15<br>17                            | $\mu\text{A}$ |
|            |  | $V_{CC} = 3.0\text{ V}$<br>$T_A = 25^\circ\text{C}$<br>$T_A = T_{LOW}$ to $T_{HIGH}$                                 | -                                   | 8.0<br>-             | 15<br>17                            |               |
|            |  | $V_{CC} = 6.0\text{ V}$<br>$T_A = 25^\circ\text{C}$<br>$T_A = T_{LOW}$ to $T_{HIGH}$                                 | -                                   | 9.0<br>-             | 15<br>17                            |               |
| $V_{OH}$   | Output Voltage High                      | $V_{CC} = 0.85\text{ V}$ , $I_{source} = 0.5\text{ mA}$<br>$T_A = 25^\circ\text{C}$<br>$T_A = T_{LOW}$ to $T_{HIGH}$ | $V_{CC} - 0.25$<br>$V_{CC} - 0.275$ | $V_{CC} - 0.10$<br>- | -                                   | V             |
|            |  | $V_{CC} = 3.0\text{ V}$ , $I_{source} = 3.0\text{ mA}$<br>$T_A = 25^\circ\text{C}$<br>$T_A = T_{LOW}$ to $T_{HIGH}$  | $V_{CC} - 0.3$<br>$V_{CC} - 0.35$   | $V_{CC} - 0.12$<br>- | -                                   |               |
|            |  | $V_{CC} = 6.0\text{ V}$ , $I_{source} = 5.0\text{ mA}$<br>$T_A = 25^\circ\text{C}$<br>$T_A = T_{LOW}$ to $T_{HIGH}$  | $V_{CC} - 0.3$<br>$V_{CC} - 0.35$   | $V_{CC} - 0.12$<br>- | -                                   |               |
| $V_{OL}$   | Output Voltage Low                       | $V_{CC} = 0.85\text{ V}$ , $I_{sink} = 0.5\text{ mA}$<br>$T_A = 25^\circ\text{C}$<br>$T_A = T_{LOW}$ to $T_{HIGH}$   | -                                   | $V_{EE} + 0.10$<br>- | $V_{EE} + 0.25$<br>$V_{EE} + 0.275$ | V             |
|            |  | $V_{CC} = 3.0\text{ V}$ , $I_{sink} = 3.0\text{ mA}$<br>$T_A = 25^\circ\text{C}$<br>$T_A = T_{LOW}$ to $T_{HIGH}$    | -                                   | $V_{EE} + 0.12$<br>- | $V_{EE} + 0.3$<br>$V_{EE} + 0.35$   |               |
|            |  | $V_{CC} = 6.0\text{ V}$ , $I_{sink} = 5.0\text{ mA}$<br>$T_A = 25^\circ\text{C}$<br>$T_A = T_{LOW}$ to $T_{HIGH}$    | -                                   | $V_{EE} + 0.12$<br>- | $V_{EE} + 0.3$<br>$V_{EE} + 0.35$   |               |
| $t_{PHL}$  | Propagation Delay, High-to-Low           | 20 mV Overdrive, $C_L = 15\text{ pF}$ ,<br>$V_{CC} = 2.85\text{ V}$  | -                                   | 625                  | -                                   | ns            |
| $t_{PLH}$  | Propagation Delay, Low-to-High           |  | -                                   | 750                  | -                                   | ns            |
| $t_{FALL}$ | Output Fall Time                         | $V_{CC} = 6.0\text{ V}$ , $C_L = 50\text{ pF}$ (Note 9)  | -                                   | 22                   | -                                   | ns            |
| $t_{RISE}$ | Output Rise Time                         | $V_{CC} = 6.0\text{ V}$ , $C_L = 50\text{ pF}$ (Note 9)  | -                                   | 20                   | -                                   | ns            |

Product parametric performance is indicated in the Electrical Characteristics for the listed test conditions, unless otherwise noted. Product performance may not be indicated by the Electrical Characteristics if operated under different conditions.

8. The limits over the extended temperature range are guaranteed by design only.

9. Input signal: 1 kHz, squarewave signal with 10 ns edge rate.

10. NCS2200A:  $T_{LOW} = -40^\circ\text{C}$ ,  $T_{HIGH} = +105^\circ\text{C}$ ; NCV2200A:  $T_{LOW} = -40^\circ\text{C}$ ,  $T_{HIGH} = +125^\circ\text{C}$ .

# NCS2200, NCS2200A, NCS2202, NCS2202A

**NCS2202A ELECTRICAL CHARACTERISTICS** (For all values  $V_{CC} = 0.85\text{ V}$  to  $6.0\text{ V}$ ,  $V_{EE} = 0\text{ V}$ ,  $T_A = 25^\circ\text{C}$ ,  $R_{pullup} = 10\text{ k}\Omega$ , unless otherwise noted.) (Note 11)

| Symbol     | Parameter                                | Conditions  | Min          | Typ                  | Max                                 | Unit          |
|------------|--|---|--------------|----------------------|-------------------------------------|---------------|
| $V_{HYS}$  | Input Hysteresis                         | $T_A = 25^\circ\text{C}$  | 2.0          | 4.5                  | 20                                  | mV            |
| $V_{IO}$   | Input Offset Voltage                     | $V_{CC} = 0.85\text{ V}$<br>$T_A = 25^\circ\text{C}$<br>$T_A = -40^\circ\text{C}$ to $105^\circ\text{C}$                              | -10<br>-12   | 0.3<br>-             | +10<br>+12                          | mV            |
|            |  | $V_{CC} = 3.0\text{ V}$<br>$T_A = 25^\circ\text{C}$<br>$T_A = -40^\circ\text{C}$ to $105^\circ\text{C}$                               | -6.0<br>-8.0 | 0.4<br>-             | +6.0<br>+8.0                        |               |
|            |  | $V_{CC} = 6.0\text{ V}$<br>$T_A = 25^\circ\text{C}$<br>$T_A = -40^\circ\text{C}$ to $105^\circ\text{C}$                               | -5.0<br>-7.0 | 0.4<br>-             | +5.0<br>+7.0                        |               |
| $V_{CM}$   | Common Mode Voltage Range                |   | -            | $V_{EE}$ to $V_{CC}$ | -                                   | V             |
| $I_{SC}$   | Output Short-Circuit Sourcing or Sinking | $V_{out} = \text{GND}$  | -            | 60                   | -                                   | mA            |
| CMRR       | Common Mode Rejection Ratio              | $V_{CM} = V_{CC}$   | 53           | 80                   | -                                   | dB            |
| $I_{IB}$   | Input Bias Current                       |   | -            | 1.0                  | -                                   | pA            |
| PSRR       | Power Supply Rejection Ratio             | $\Delta V_S = 2.575\text{ V}$   | 45           | 80                   | -                                   | dB            |
| $I_{CC}$   | Supply Current                           | $V_{CC} = 0.85\text{ V}$<br>$T_A = 25^\circ\text{C}$<br>$T_A = -40^\circ\text{C}$ to $105^\circ\text{C}$                              | -            | 7.5<br>-             | 15<br>17                            | $\mu\text{A}$ |
|            |  | $V_{CC} = 3.0\text{ V}$<br>$T_A = 25^\circ\text{C}$<br>$T_A = -40^\circ\text{C}$ to $105^\circ\text{C}$                               | -            | 8.0<br>-             | 15<br>17                            |               |
|            |  | $V_{CC} = 6.0\text{ V}$<br>$T_A = 25^\circ\text{C}$<br>$T_A = -40^\circ\text{C}$ to $105^\circ\text{C}$                               | -            | 9.0<br>-             | 15<br>17                            |               |
| $V_{OL}$   | Output Voltage Low                       | $V_{CC} = 0.85\text{ V}$ , $I_{sink} = 0.5\text{ mA}$<br>$T_A = 25^\circ\text{C}$<br>$T_A = -40^\circ\text{C}$ to $105^\circ\text{C}$ | -            | $V_{EE} + 0.14$<br>- | $V_{EE} + 0.25$<br>$V_{EE} + 0.275$ | V             |
|            |  | $V_{CC} = 3.0\text{ V}$ , $I_{sink} = 3.0\text{ mA}$<br>$T_A = 25^\circ\text{C}$<br>$T_A = -40^\circ\text{C}$ to $105^\circ\text{C}$  | -            | $V_{EE} + 0.18$<br>- | $V_{EE} + 0.3$<br>$V_{EE} + 0.35$   |               |
|            |  | $V_{CC} = 6.0\text{ V}$ , $I_{sink} = 5.0\text{ mA}$<br>$T_A = 25^\circ\text{C}$<br>$T_A = -40^\circ\text{C}$ to $105^\circ\text{C}$  | -            | $V_{EE} + 0.20$<br>- | $V_{EE} + 0.3$<br>$V_{EE} + 0.35$   |               |
| $t_{PHL}$  | Propagation Delay – High to Low          | 20 mV Overdrive, $C_L = 15\text{ pF}$ ,<br>$V_{CC} = 2.85\text{ V}$   | -            | 580                  | -                                   | ns            |
|            |  | 50 mV Overdrive, $C_L = 15\text{ pF}$ ,<br>$V_{CC} = 2.85\text{ V}$   | -            | 350                  | -                                   |               |
|            |  | 100 mV Overdrive, $C_L = 15\text{ pF}$ ,<br>$V_{CC} = 2.85\text{ V}$  | -            | 220                  | -                                   |               |
| $t_{PLH}$  | Propagation Delay – Low to High          | 20 mV Overdrive, $C_L = 15\text{ pF}$ ,<br>$V_{CC} = 2.85\text{ V}$   | -            | 550                  | -                                   | ns            |
|            |  | 50 mV Overdrive, $C_L = 15\text{ pF}$ ,<br>$V_{CC} = 2.85\text{ V}$   | -            | 400                  | -                                   |               |
|            |  | 100 mV Overdrive, $C_L = 15\text{ pF}$ ,<br>$V_{CC} = 2.85\text{ V}$  | -            | 340                  | -                                   |               |
| $t_{FALL}$ | Output Fall Time                         | $V_{CC} = 6.0\text{ V}$ , $C_L = 50\text{ pF}$ (Note 12)  | -            | 5.0                  | -                                   | ns            |
| $t_{RISE}$ | Output Rise Time                         | $V_{CC} = 6.0\text{ V}$ , $C_L = 50\text{ pF}$ (Note 12)  | -            | 235                  | -                                   | ns            |

Product parametric performance is indicated in the Electrical Characteristics for the listed test conditions, unless otherwise noted. Product performance may not be indicated by the Electrical Characteristics if operated under different conditions.

11. The limits over the extended temperature range are guaranteed by design only.

12. Input signal: 1 kHz, squarewave signal with 10 ns edge rate.

# NCS2200, NCS2200A, NCS2202, NCS2202A

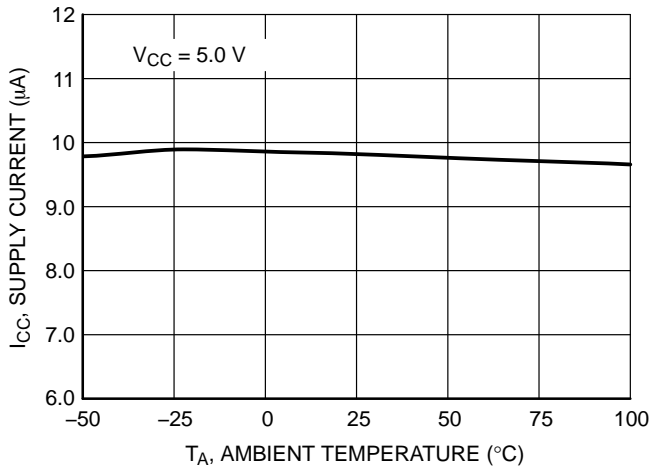

**Figure 1. NCS2200 Series Supply Current versus Temperature**

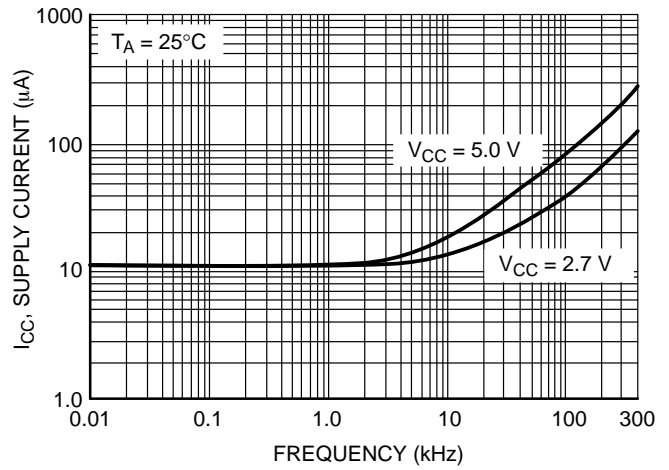

**Figure 2. NCS2200 Series Supply Current versus Output Transition Frequency**

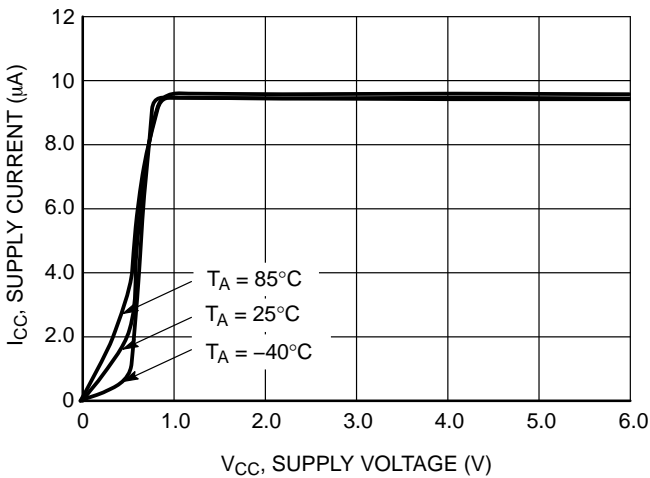

**Figure 3. NCS2200 Series Supply Current versus Supply Voltage**

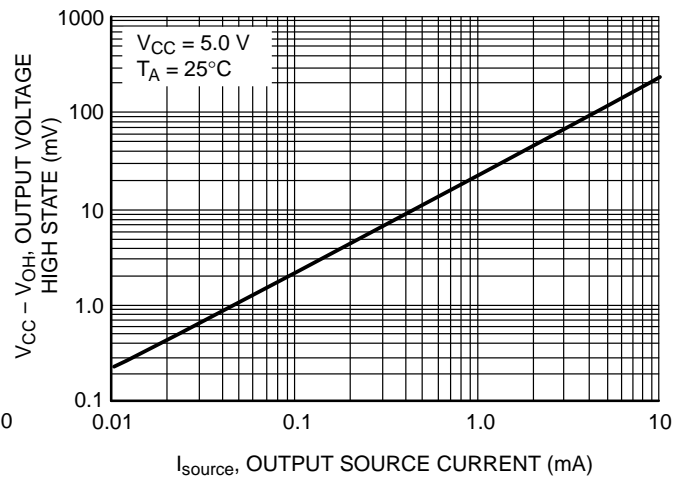

**Figure 4. NCS2200 Output Voltage High State versus Output Source Current**

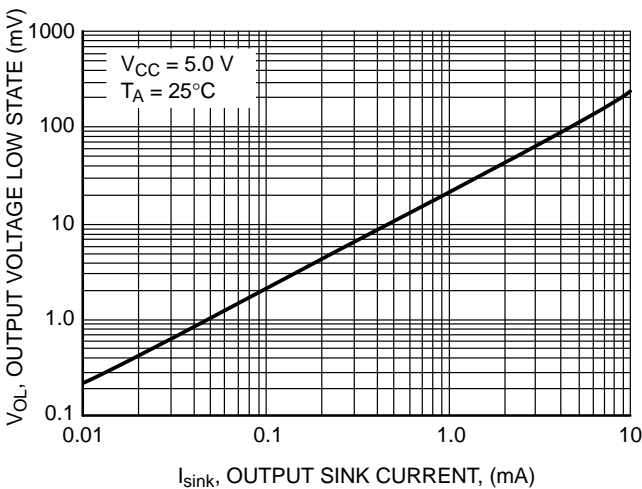

**Figure 5. NCS2200 Series Output Voltage Low State versus Output Sink Current**

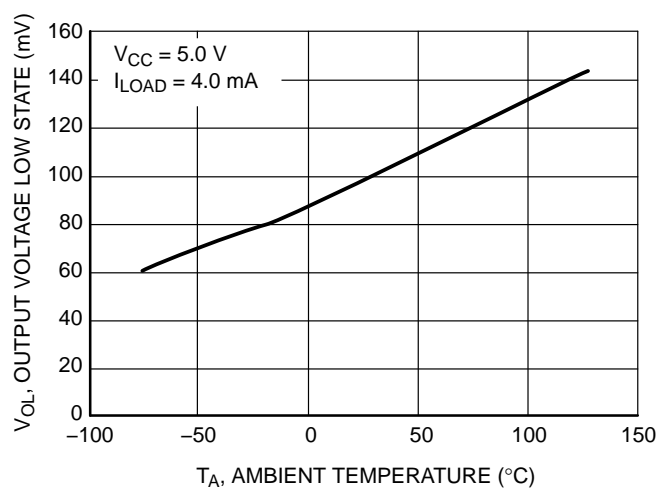

**Figure 6. NCS2200 Series Output Voltage Low State versus Temperature**



# NCS2200, NCS2200A, NCS2202, NCS2202A

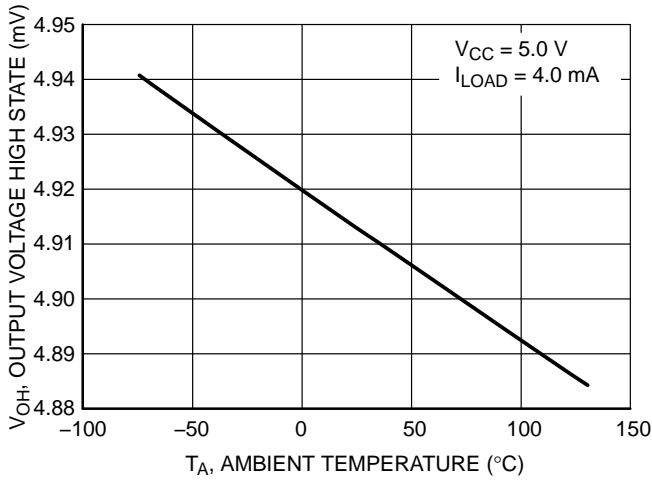

**Figure 7. NCS2200 Series Output Voltage High State versus Temperature**

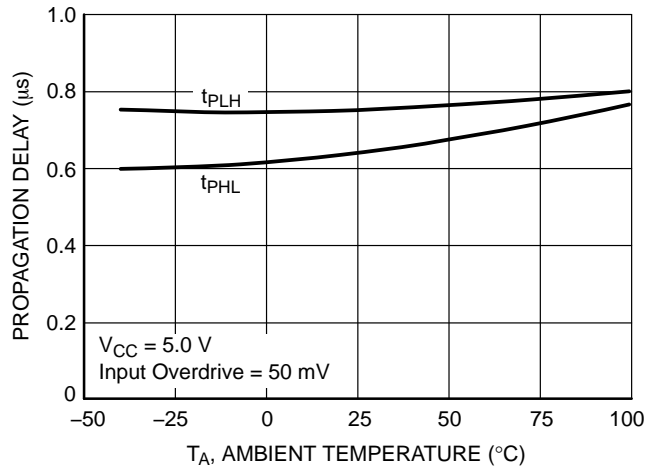

**Figure 8. NCS2200 Series Propagation Delay versus Temperature**

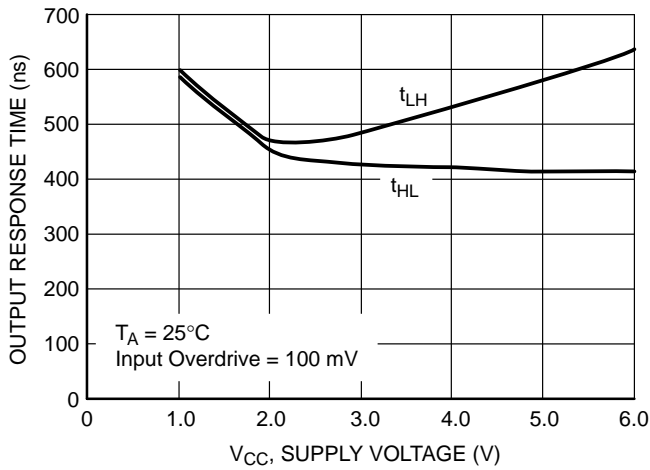

**Figure 9. NCS2200 Series Output Response Time versus Supply Voltage**

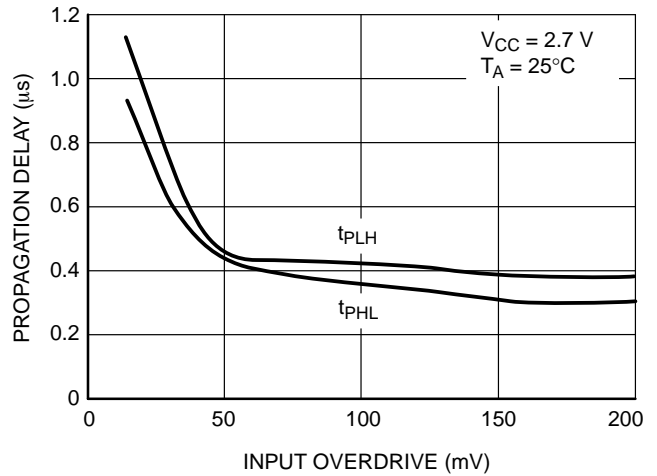

**Figure 10. NCS2200 Series Propagation Delay versus Input Overdrive**

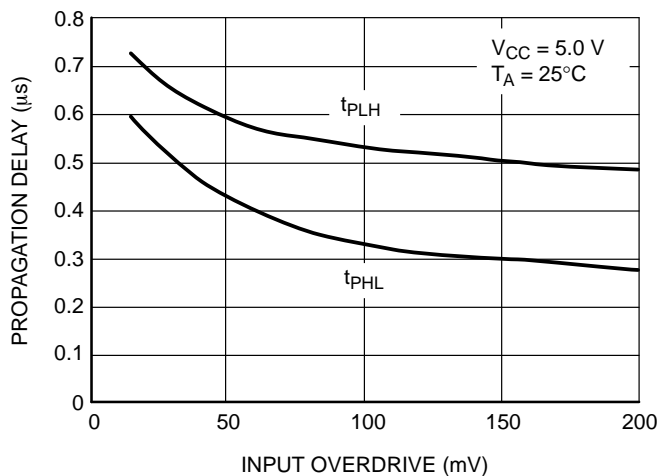

**Figure 11. NCS2200 Series Propagation Delay versus Input Overdrive**

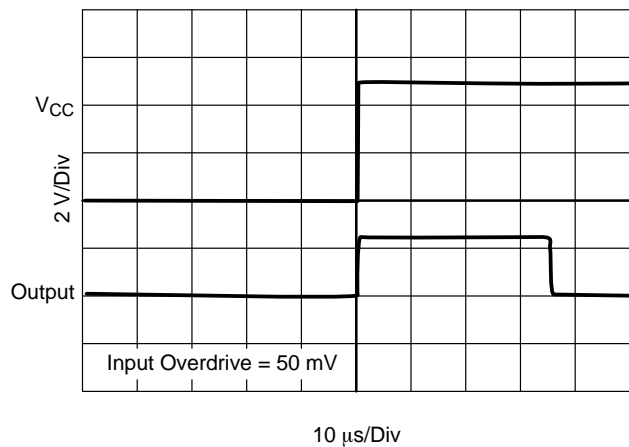

**Figure 12. NCS2200 Series Powerup Delay**

NCS2200, NCS2200A, NCS2202, NCS2202A

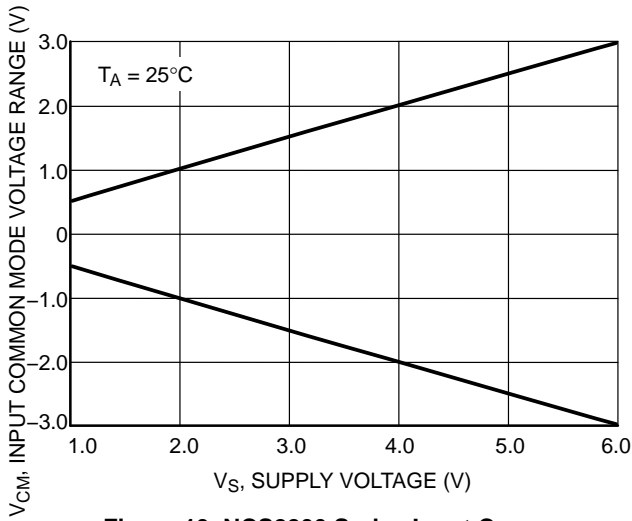

Figure 13. NCS2200 Series Input Common Mode Voltage Range versus Supply Voltage

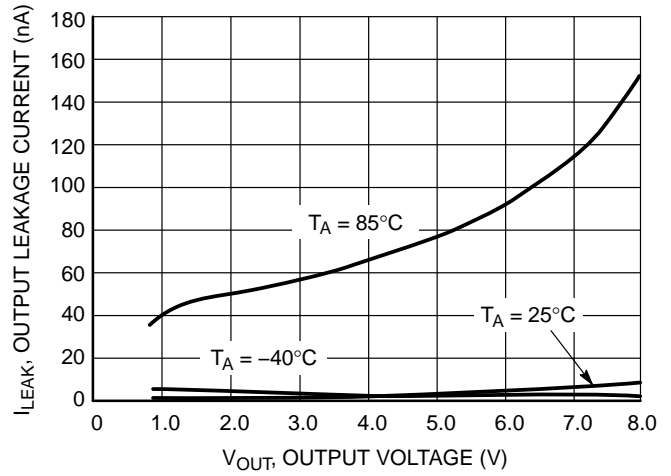

Figure 14. NCS2202 Output Leakage Current versus Output Voltage

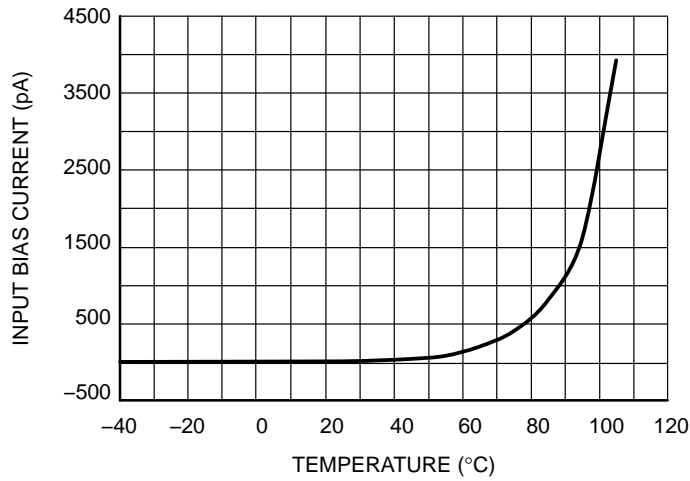

Figure 15. Input Bias Current versus Temperature

## NCS2200, NCS2200A, NCS2202, NCS2202A

### OPERATING DESCRIPTION

The NCS2200 series is an industry first sub-one volt, low power comparator family. This series is designed for rail-to-rail input and output performance. These devices consume only 10  $\mu$ A of supply current while achieving a typical propagation delay of 1.1  $\mu$ s at a 20 mV input overdrive. Figures 10 and 11 show propagation delay with various input overdrives. This comparator family is guaranteed to operate at a low voltage of 0.85 V up to 6.0 V. This is accomplished by the use of a modified analog CMOS process that implements depletion MOSFET devices. The common-mode input voltage range extends 0.1 V beyond the upper and lower rail without phase inversion or other adverse effects. This series is available in the SOT-23-5

package. Additionally, the NCS2200 device is available in the tiny DFN 2x2.2 package and the SC70-5 package. NCS2200A is available in UDFN package.

### Output Stage

The NCS2200 has a complementary P and N Channel output stage that has capability of driving a rail-to-rail output swing with a load ranging up to 5.0 mA. It is designed such that shoot-through current is minimized while switching. This feature eliminates the need for bypass capacitors under most circumstances.

The NCS2202 has an open drain N-channel output stage that can be pulled up to 6.0 V (max) with an external resistor. This facilitates mixed voltage system applications.

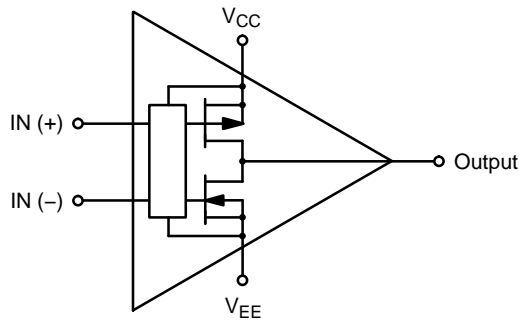

**Figure 16. NCS2200/NCS2200A Complementary Push-Pull Output**

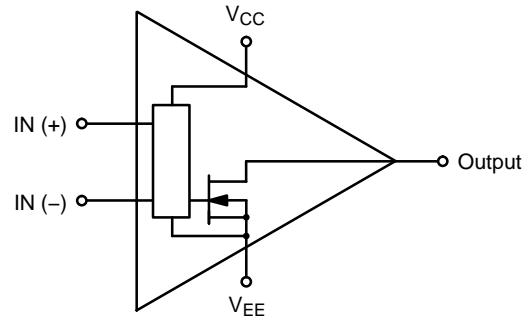

**Figure 17. NCS2202/NCS2202A Open Drain Output Configuration**

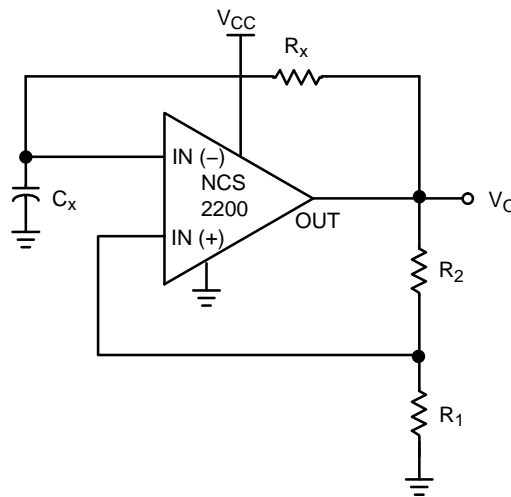

The oscillation frequency can be programmed as follows:

$$f = \frac{1}{T} = \frac{1}{2.2 R_x C_x}$$

**Figure 18. Schmitt Trigger Oscillator**

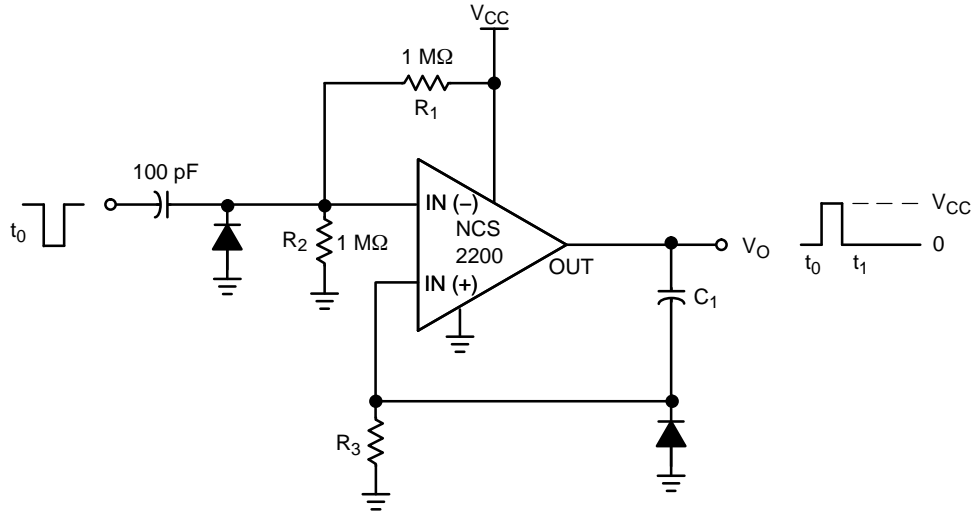

The resistor divider  $R_1$  and  $R_2$  can be used to set the magnitude of the input pulse. The pulse width is set by adjusting  $C_1$  and  $R_3$ .

**Figure 19. One-Shot Multivibrator**

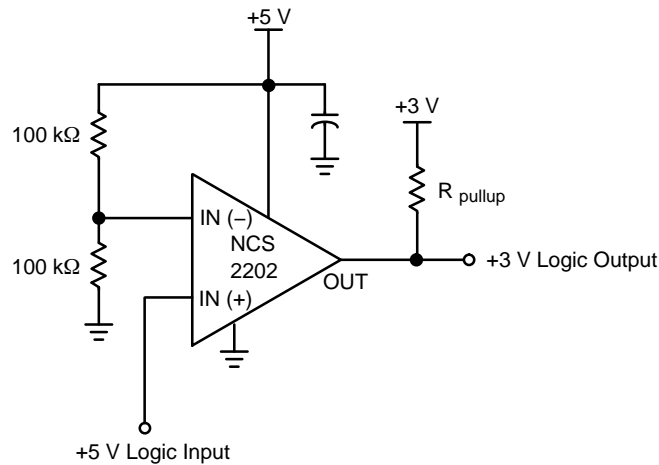

This circuit converts 5 V logic to 3 V logic. Using the NCS2202/A allows for full 5 V logic swing without creating overvoltage on the 3 V logic input.

**Figure 20. Logic Level Translator**

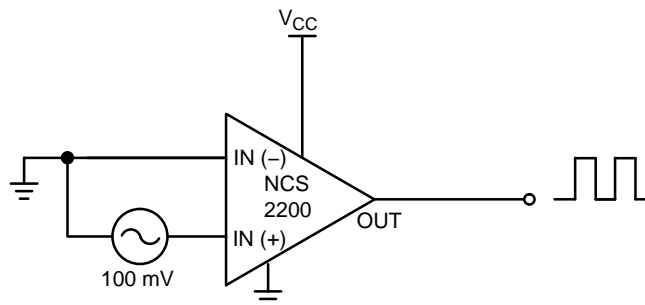

**Figure 21. Zero-Crossing Detector**

## NCS2200, NCS2200A, NCS2202, NCS2202A

### ORDERING INFORMATION

| Device         | Pinout Style | Output Type             | Package                        | Shipping†          |
|----------------|--------------|-------------------------|--------------------------------|--------------------|
| NCS2200AMUT1G  | N/A          | Complementary Push-Pull | UDFN<br>(Pb-Free)              | 3000 / Tape & Reel |
| NCV2200AMUTBG* | N/A          | Complementary Push-Pull | UDFN<br>(Pb-Free)              | 3000 / Tape & Reel |
| NCS2200SN1T1G  | 1            | Complementary Push-Pull | SOT-23-5 (TSOP-5)<br>(Pb-Free) | 3000 / Tape & Reel |
| NCV2200SN1T1G* | 1            | Complementary Push-Pull | SOT-23-5 (TSOP-5)<br>(Pb-Free) | 3000 / Tape & Reel |
| NCS2200SN2T1G  | 2            | Complementary Push-Pull | SOT-23-5 (TSOP-5)<br>(Pb-Free) | 3000 / Tape & Reel |
| NCV2200SN2T1G* | 2            | Complementary Push-Pull | SOT-23-5 (TSOP-5)<br>(Pb-Free) | 3000 / Tape & Reel |
| NCS2200SQ2T2G  | 2            | Complementary Push-Pull | SC70-5<br>(Pb-Free)            | 3000 / Tape & Reel |
| NCV2200SQ2T2G* | 2            | Complementary Push-Pull | SC70-5<br>(Pb-Free)            | 3000 / Tape & Reel |
| NCS2200SQT1G   | N/A          | Complementary Push-Pull | DFN, 2x2.2<br>(Pb-Free)        | 3000 / Tape & Reel |
| NCS2202SN1T1G  | 1            | Open Drain              | SOT-23-5 (TSOP-5)<br>(Pb-Free) | 3000 / Tape & Reel |
| NCS2202SN2T1G  | 2            | Open Drain              | SOT-23-5 (TSOP-5)<br>(Pb-Free) | 3000 / Tape & Reel |
| NCV2202SN2T1G* | 2            | Open Drain              | SOT-23-5 (TSOP-5)<br>(Pb-Free) | 3000 / Tape & Reel |
| NCS2202SQ1T2G  | 1            | Open Drain              | SC70-5<br>(Pb-Free)            | 3000 / Tape & Reel |
| NCS2202SQ2T2G  | 2            | Open Drain              | SC70-5<br>(Pb-Free)            | 3000 / Tape & Reel |
| NCS2202AMUTBG  | N/A          | Open Drain              | UDFN<br>(Pb-Free)              | 3000 / Tape & Reel |

This device contains 93 active transistors.

†For information on tape and reel specifications, including part orientation and tape sizes, please refer to our Tape and Reel Packaging Specifications Brochure, BRD8011/D.

\*NCV Prefix for Automotive and Other Applications Requiring Unique Site and Control Change Requirements; AEC-Q100 Qualified and PPAP Capable.

# NCS2200, NCS2200A, NCS2202, NCS2202A

## MARKING DIAGRAMS

**SOT-23-5  
(TSOP-5)  
SN SUFFIX  
CASE 483**

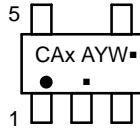

- x = I for NCS2200SN1T1
- J for NCS2200SN2T1
- M for NCS2202SN1T1
- N for NCS2202SN2T1
- A = Assembly Location
- Y = Year
- W = Work Week
- = Pb-Free Package

(Note: Microdot may be in either location)

**SC70-5  
SQ SUFFIX  
CASE 419A**

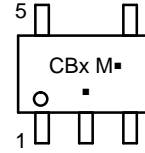

- CBx = Specific Device Code
- x = A for NCS2200SQ2T2
- D for NCS2202SQ1T2G
- E for NCS2202SQ2T2G
- M = Date Code\*
- = Pb-Free Package

(Note: Microdot may be in either location)  
\*Date Code orientation, position, and underbar may vary depending upon manufacturing location.

**DFN6 2x2.2  
SQL SUFFIX  
CASE 488**

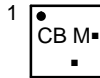

- CB = Specific Device Code
- M = Date Code\*
- = Pb-Free Package

(Note: Microdot may be in either location)

\*Date Code overbar and underbar may vary depending upon manufacturing location.

**UDFN6 1.2x1.0  
MU SUFFIX  
CASE 517AA**

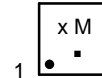

(Top View)

- x = S for Specific Device Code
- V for NCS2202A (V with 180° Rotation)
- M = Date Code
- = Pb-Free Package

# MECHANICAL CASE OUTLINE

## PACKAGE DIMENSIONS

ON Semiconductor®



SCALE 2:1

SC-88A (SC-70-5/SOT-353)  
CASE 419A-02  
ISSUE L

DATE 17 JAN 2013

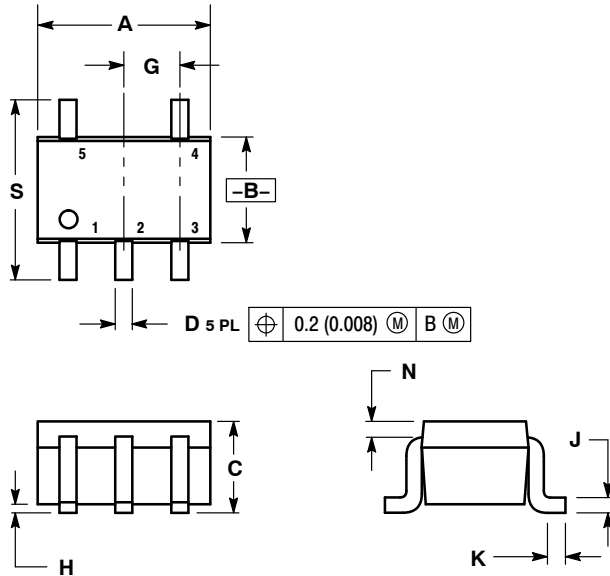

### SOLDER FOOTPRINT



NOTES:

1. DIMENSIONING AND TOLERANCING PER ANSI Y14.5M, 1982.
2. CONTROLLING DIMENSION: INCH.
3. 419A-01 OBSOLETE. NEW STANDARD 419A-02.
4. DIMENSIONS A AND B DO NOT INCLUDE MOLD FLASH, PROTRUSIONS, OR GATE BURRS.

| DIM | INCHES    |       | MILLIMETERS |      |
|-----|-----------|-------|-------------|------|
|     | MIN       | MAX   | MIN         | MAX  |
| A   | 0.071     | 0.087 | 1.80        | 2.20 |
| B   | 0.045     | 0.053 | 1.15        | 1.35 |
| C   | 0.031     | 0.043 | 0.80        | 1.10 |
| D   | 0.004     | 0.012 | 0.10        | 0.30 |
| G   | 0.026 BSC |       | 0.65 BSC    |      |
| H   | ---       | 0.004 | ---         | 0.10 |
| J   | 0.004     | 0.010 | 0.10        | 0.25 |
| K   | 0.004     | 0.012 | 0.10        | 0.30 |
| N   | 0.008 REF |       | 0.20 REF    |      |
| S   | 0.079     | 0.087 | 2.00        | 2.20 |

### GENERIC MARKING DIAGRAM\*

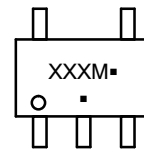

- XXX = Specific Device Code
- M = Date Code
- = Pb-Free Package

(Note: Microdot may be in either location)

\*This information is generic. Please refer to device data sheet for actual part marking. Pb-Free indicator, "G" or microdot "■", may or may not be present. Some products may not follow the Generic Marking.

- |  |  |  |  |  |
|--|--|--|--|--|
| <p>STYLE 1:<br/>PIN 1. BASE<br/>2. EMITTER<br/>3. BASE<br/>4. COLLECTOR<br/>5. COLLECTOR</p>                   | <p>STYLE 2:<br/>PIN 1. ANODE<br/>2. EMITTER<br/>3. BASE<br/>4. COLLECTOR<br/>5. CATHODE</p>  | <p>STYLE 3:<br/>PIN 1. ANODE 1<br/>2. N/C<br/>3. ANODE 2<br/>4. CATHODE 2<br/>5. CATHODE 1</p> | <p>STYLE 4:<br/>PIN 1. SOURCE 1<br/>2. DRAIN 1/2<br/>3. SOURCE 1<br/>4. GATE 1<br/>5. GATE 2</p> | <p>STYLE 5:<br/>PIN 1. CATHODE<br/>2. COMMON ANODE<br/>3. CATHODE 2<br/>4. CATHODE 3<br/>5. CATHODE 4</p>  |
| <p>STYLE 6:<br/>PIN 1. EMITTER 2<br/>2. BASE 2<br/>3. EMITTER 1<br/>4. COLLECTOR<br/>5. COLLECTOR 2/BASE 1</p> | <p>STYLE 7:<br/>PIN 1. BASE<br/>2. EMITTER<br/>3. BASE<br/>4. COLLECTOR<br/>5. COLLECTOR</p> | <p>STYLE 8:<br/>PIN 1. CATHODE<br/>2. COLLECTOR<br/>3. N/C<br/>4. BASE<br/>5. EMITTER</p>      | <p>STYLE 9:<br/>PIN 1. ANODE<br/>2. CATHODE<br/>3. ANODE<br/>4. ANODE<br/>5. ANODE</p>           | <p>Note: Please refer to datasheet for style callout. If style type is not called out in the datasheet refer to the device datasheet pinout or pin assignment.</p> |

|                  |                          |  |
|------------------|--------------------------|--|
| DOCUMENT NUMBER: | 98ASB42984B              | Electronic versions are uncontrolled except when accessed directly from the Document Repository. Printed versions are uncontrolled except when stamped "CONTROLLED COPY" in red. |
| DESCRIPTION:     | SC-88A (SC-70-5/SOT-353) | PAGE 1 OF 1  |

ON Semiconductor and ON are trademarks of Semiconductor Components Industries, LLC dba ON Semiconductor or its subsidiaries in the United States and/or other countries. ON Semiconductor reserves the right to make changes without further notice to any products herein. ON Semiconductor makes no warranty, representation or guarantee regarding the suitability of its products for any particular purpose, nor does ON Semiconductor assume any liability arising out of the application or use of any product or circuit, and specifically disclaims any and all liability, including without limitation special, consequential or incidental damages. ON Semiconductor does not convey any license under its patent rights nor the rights of others.

# MECHANICAL CASE OUTLINE PACKAGE DIMENSIONS

ON Semiconductor®



SCALE 2:1

## TSOP-5 CASE 483 ISSUE N

DATE 12 AUG 2020

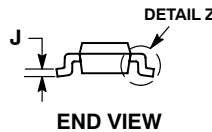
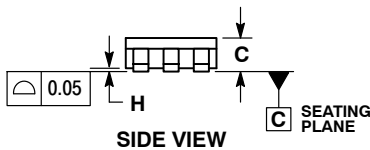

NOTES:

1. DIMENSIONING AND TOLERANCING PER ASME Y14.5M, 1994.
2. CONTROLLING DIMENSION: MILLIMETERS.
3. MAXIMUM LEAD THICKNESS INCLUDES LEAD FINISH THICKNESS. MINIMUM LEAD THICKNESS IS THE MINIMUM THICKNESS OF BASE MATERIAL.
4. DIMENSIONS A AND B DO NOT INCLUDE MOLD FLASH, PROTRUSIONS, OR GATE BURRS. MOLD FLASH, PROTRUSIONS, OR GATE BURRS SHALL NOT EXCEED 0.15 PER SIDE. DIMENSION A.
5. OPTIONAL CONSTRUCTION: AN ADDITIONAL TRIMMED LEAD IS ALLOWED IN THIS LOCATION. TRIMMED LEAD NOT TO EXTEND MORE THAN 0.2 FROM BODY.

| DIM | MILLIMETERS |      |
|-----|-------------|------|
|     | MIN         | MAX  |
| A   | 2.85        | 3.15 |
| B   | 1.35        | 1.65 |
| C   | 0.90        | 1.10 |
| D   | 0.25        | 0.50 |
| G   | 0.95 BSC    |      |
| H   | 0.01        | 0.10 |
| J   | 0.10        | 0.26 |
| K   | 0.20        | 0.60 |
| M   | 0°          | 10°  |
| S   | 2.50        | 3.00 |

### SOLDERING FOOTPRINT\*



\*For additional information on our Pb-Free strategy and soldering details, please download the ON Semiconductor Soldering and Mounting Techniques Reference Manual, SOLDERRM/D.

### GENERIC MARKING DIAGRAM\*

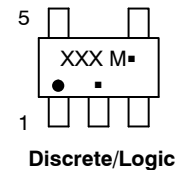

- XXX = Specific Device Code    XXX = Specific Device Code  
 A = Assembly Location        M = Date Code  
 Y = Year                            ▪ = Pb-Free Package  
 W = Work Week  
 ▪ = Pb-Free Package

(Note: Microdot may be in either location)

\*This information is generic. Please refer to device data sheet for actual part marking. Pb-Free indicator, "G" or microdot "▪", may or may not be present.

|                  |             |  |
|------------------|-------------|--|
| DOCUMENT NUMBER: | 98ARB18753C | Electronic versions are uncontrolled except when accessed directly from the Document Repository. Printed versions are uncontrolled except when stamped "CONTROLLED COPY" in red. |
| DESCRIPTION:     | TSOP-5      | PAGE 1 OF 1  |

ON Semiconductor and ON are trademarks of Semiconductor Components Industries, LLC dba ON Semiconductor or its subsidiaries in the United States and/or other countries. ON Semiconductor reserves the right to make changes without further notice to any products herein. ON Semiconductor makes no warranty, representation or guarantee regarding the suitability of its products for any particular purpose, nor does ON Semiconductor assume any liability arising out of the application or use of any product or circuit, and specifically disclaims any and all liability, including without limitation special, consequential or incidental damages. ON Semiconductor does not convey any license under its patent rights nor the rights of others.



# MECHANICAL CASE OUTLINE

## PACKAGE DIMENSIONS

ON Semiconductor®

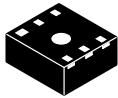

DFN6 2x2.2 mm  
CASE 488-03  
ISSUE G

DATE 06 FEB 2006

SCALE 4:1

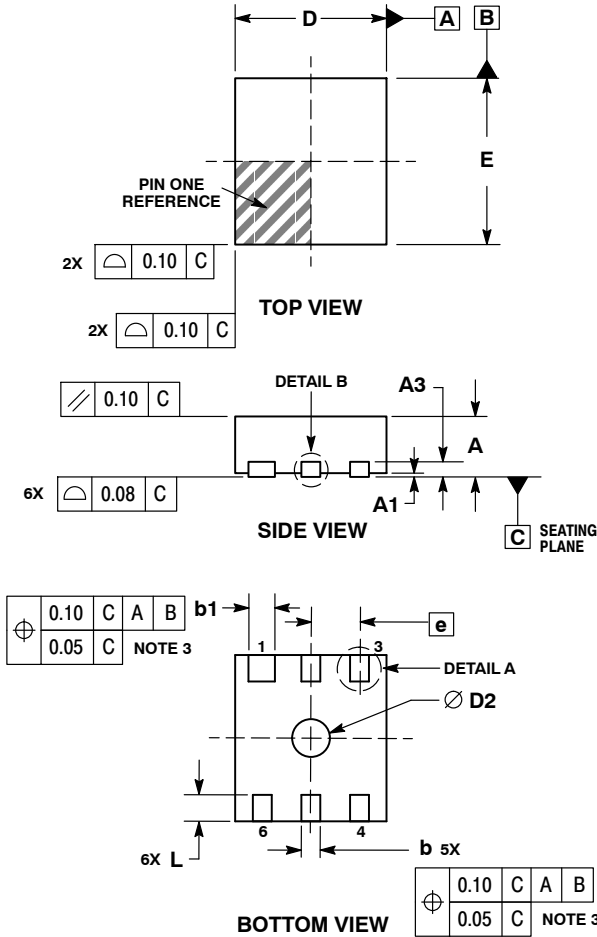

NOTES:

1. DIMENSIONING AND TOLERANCING PER ASME Y14.5M, 1994.
2. CONTROLLING DIMENSION: MILLIMETERS.
3. DIMENSION b APPLIES TO PLATED TERMINAL AND IS MEASURED BETWEEN 0.25 AND 0.30mm FROM TERMINAL.
4. COPLANARITY APPLIES TO THE EXPOSED PAD AS WELL AS THE TERMINALS.
5. TERMINAL b MAY HAVE MOLD COMPOUND MATERIAL ALONG SIDE EDGE.
6. DETAILS A AND B SHOW OPTIONAL VIEWS FOR END OF TERMINAL LEAD AT EDGE OF PACKAGE AND SIDE EDGE OF PACKAGE.

| DIM | MILLIMETERS |      |      |
|-----|-------------|------|------|
|     | MIN         | NOM  | MAX  |
| A   | 0.80        | 0.90 | 1.00 |
| A1  | 0.00        | 0.03 | 0.05 |
| A3  | 0.20 REF    |      |      |
| b   | 0.20        | 0.25 | 0.30 |
| b1  | 0.30        | 0.35 | 0.40 |
| D   | 2.00 BSC    |      |      |
| D2  | 0.40        | 0.50 | 0.60 |
| E   | 2.20 BSC    |      |      |
| e   | 0.65 BSC    |      |      |
| L   | 0.30        | 0.35 | 0.40 |
| L1  | 0.00        | 0.05 | 0.10 |

GENERIC MARKING DIAGRAM\*



xx = Specific Device Code  
M = Date Code

\*This information is generic. Please refer to device data sheet for actual part marking.

SOLDERING FOOTPRINT\*

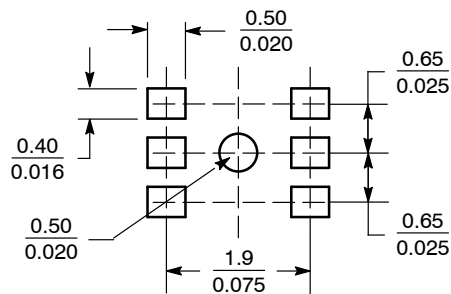

SCALE 10:1

\*For additional information on our Pb-Free strategy and soldering details, please download the ON Semiconductor Soldering and Mounting Techniques Reference Manual, SOLDERRM/D.

|                  |                            |  |
|------------------|----------------------------|--|
| DOCUMENT NUMBER: | 98AON04199D                | Electronic versions are uncontrolled except when accessed directly from the Document Repository. Printed versions are uncontrolled except when stamped "CONTROLLED COPY" in red. |
| DESCRIPTION:     | DFN6 2 X 2.2 X 0.9 X 0.65P | PAGE 1 OF 1  |

ON Semiconductor and are trademarks of Semiconductor Components Industries, LLC dba ON Semiconductor or its subsidiaries in the United States and/or other countries. ON Semiconductor reserves the right to make changes without further notice to any products herein. ON Semiconductor makes no warranty, representation or guarantee regarding the suitability of its products for any particular purpose, nor does ON Semiconductor assume any liability arising out of the application or use of any product or circuit, and specifically disclaims any and all liability, including without limitation special, consequential or incidental damages. ON Semiconductor does not convey any license under its patent rights nor the rights of others.

# MECHANICAL CASE OUTLINE

## PACKAGE DIMENSIONS

ON Semiconductor®



### UDFN6, 1.2x1.0, 0.4P CASE 517AA-01 ISSUE D

DATE 03 SEP 2010

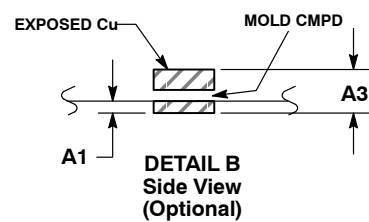
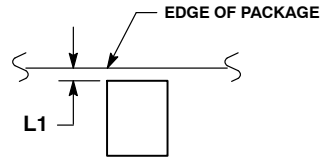
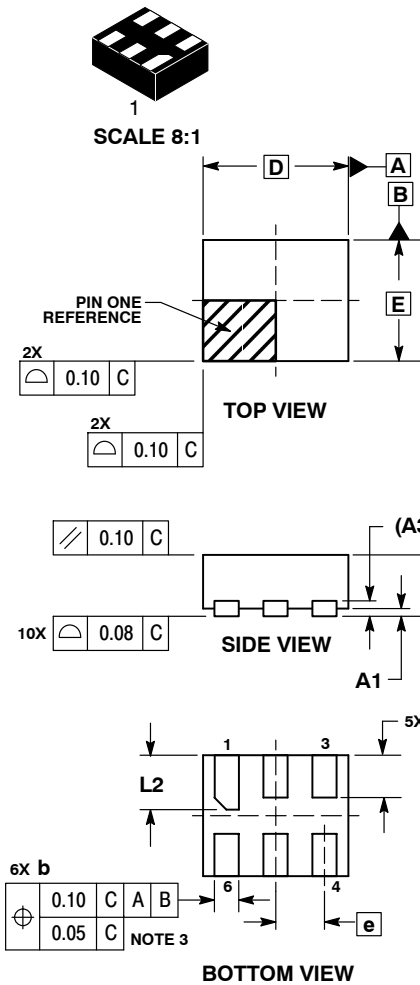

- NOTES:
1. DIMENSIONING AND TOLERANCING PER ASME Y14.5M, 1994.
  2. CONTROLLING DIMENSION: MILLIMETERS.
  3. DIMENSION b APPLIES TO PLATED TERMINAL AND IS MEASURED BETWEEN 0.25 AND 0.30 mm FROM TERMINAL.
  4. COPLANARITY APPLIES TO THE EXPOSED PAD AS WELL AS THE TERMINALS.

| MILLIMETERS |       |      |
|-------------|-------|------|
| DIM         | MIN   | MAX  |
| A           | 0.45  | 0.55 |
| A1          | 0.00  | 0.05 |
| A3          | 0.127 | REF  |
| b           | 0.15  | 0.25 |
| D           | 1.20  | BSC  |
| E           | 1.00  | BSC  |
| e           | 0.40  | BSC  |
| L           | 0.30  | 0.40 |
| L1          | 0.00  | 0.15 |
| L2          | 0.40  | 0.50 |

#### GENERIC MARKING DIAGRAM\*



X = Specific Device Code  
M = Date Code

\*This information is generic. Please refer to device data sheet for actual part marking. Pb-Free indicator, "G" or microdot "▪", may or may not be present.

#### MOUNTING FOOTPRINT\*

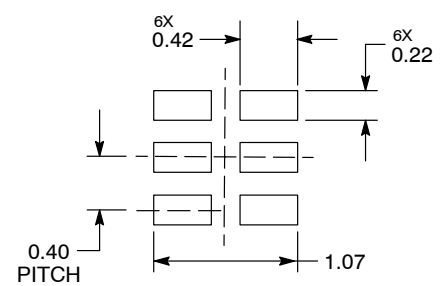

DIMENSIONS: MILLIMETERS

\*For additional information on our Pb-Free strategy and soldering details, please download the ON Semiconductor Soldering and Mounting Techniques Reference Manual, SOLDERRM/D.

|                         |                                  |  |
|-------------------------|----------------------------------|--|
| <b>DOCUMENT NUMBER:</b> | <b>98AON22068D</b>               | Electronic versions are uncontrolled except when accessed directly from the Document Repository. Printed versions are uncontrolled except when stamped "CONTROLLED COPY" in red. |
| <b>DESCRIPTION:</b>     | <b>6 PIN UDFN, 1.2X1.0, 0.4P</b> | <b>PAGE 1 OF 1</b>   |

ON Semiconductor and are trademarks of Semiconductor Components Industries, LLC dba ON Semiconductor or its subsidiaries in the United States and/or other countries. ON Semiconductor reserves the right to make changes without further notice to any products herein. ON Semiconductor makes no warranty, representation or guarantee regarding the suitability of its products for any particular purpose, nor does ON Semiconductor assume any liability arising out of the application or use of any product or circuit, and specifically disclaims any and all liability, including without limitation special, consequential or incidental damages. ON Semiconductor does not convey any license under its patent rights nor the rights of others.

ON Semiconductor and  are trademarks of Semiconductor Components Industries, LLC dba ON Semiconductor or its subsidiaries in the United States and/or other countries. ON Semiconductor owns the rights to a number of patents, trademarks, copyrights, trade secrets, and other intellectual property. A listing of ON Semiconductor's product/patent coverage may be accessed at [www.onsemi.com/site/pdf/Patent-Marking.pdf](http://www.onsemi.com/site/pdf/Patent-Marking.pdf). ON Semiconductor reserves the right to make changes without further notice to any products herein. ON Semiconductor makes no warranty, representation or guarantee regarding the suitability of its products for any particular purpose, nor does ON Semiconductor assume any liability arising out of the application or use of any product or circuit, and specifically disclaims any and all liability, including without limitation special, consequential or incidental damages. Buyer is responsible for its products and applications using ON Semiconductor products, including compliance with all laws, regulations and safety requirements or standards, regardless of any support or applications information provided by ON Semiconductor. "Typical" parameters which may be provided in ON Semiconductor data sheets and/or specifications can and do vary in different applications and actual performance may vary over time. All operating parameters, including "Typicals" must be validated for each customer application by customer's technical experts. ON Semiconductor does not convey any license under its patent rights nor the rights of others. ON Semiconductor products are not designed, intended, or authorized for use as a critical component in life support systems or any FDA Class 3 medical devices or medical devices with a same or similar classification in a foreign jurisdiction or any devices intended for implantation in the human body. Should Buyer purchase or use ON Semiconductor products for any such unintended or unauthorized application, Buyer shall indemnify and hold ON Semiconductor and its officers, employees, subsidiaries, affiliates, and distributors harmless against all claims, costs, damages, and expenses, and reasonable attorney fees arising out of, directly or indirectly, any claim of personal injury or death associated with such unintended or unauthorized use, even if such claim alleges that ON Semiconductor was negligent regarding the design or manufacture of the part. ON Semiconductor is an Equal Opportunity/Affirmative Action Employer. This literature is subject to all applicable copyright laws and is not for resale in any manner.

## PUBLICATION ORDERING INFORMATION

### LITERATURE FULFILLMENT:

Email Requests to: [orderlit@onsemi.com](mailto:orderlit@onsemi.com)

ON Semiconductor Website: [www.onsemi.com](http://www.onsemi.com)

### TECHNICAL SUPPORT

North American Technical Support:  
Voice Mail: 1 800-282-9855 Toll Free USA/Canada  
Phone: 011 421 33 790 2910

Europe, Middle East and Africa Technical Support:

Phone: 00421 33 790 2910

For additional information, please contact your local Sales Representative