

ON Semiconductor

Is Now

onsemi™

To learn more about onsemi™, please visit our website at
www.onsemi.com

onsemi and **onsemi** and other names, marks, and brands are registered and/or common law trademarks of Semiconductor Components Industries, LLC dba "**onsemi**" or its affiliates and/or subsidiaries in the United States and/or other countries. **onsemi** owns the rights to a number of patents, trademarks, copyrights, trade secrets, and other intellectual property. A listing of **onsemi** product/patent coverage may be accessed at www.onsemi.com/site/pdf/Patent-Marking.pdf. **onsemi** reserves the right to make changes at any time to any products or information herein, without notice. The information herein is provided "as-is" and **onsemi** makes no warranty, representation or guarantee regarding the accuracy of the information, product features, availability, functionality, or suitability of its products for any particular purpose, nor does **onsemi** assume any liability arising out of the application or use of any product or circuit, and specifically disclaims any and all liability, including without limitation special, consequential or incidental damages. Buyer is responsible for its products and applications using **onsemi** products, including compliance with all laws, regulations and safety requirements or standards, regardless of any support or applications information provided by **onsemi**. "Typical" parameters which may be provided in **onsemi** data sheets and/or specifications can and do vary in different applications and actual performance may vary over time. All operating parameters, including "Typicals" must be validated for each customer application by customer's technical experts. **onsemi** does not convey any license under any of its intellectual property rights nor the rights of others. **onsemi** products are not designed, intended, or authorized for use as a critical component in life support systems or any FDA Class 3 medical devices or medical devices with a same or similar classification in a foreign jurisdiction or any devices intended for implantation in the human body. Should Buyer purchase or use **onsemi** products for any such unintended or unauthorized application, Buyer shall indemnify and hold **onsemi** and its officers, employees, subsidiaries, affiliates, and distributors harmless against all claims, costs, damages, and expenses, and reasonable attorney fees arising out of, directly or indirectly, any claim of personal injury or death associated with such unintended or unauthorized use, even if such claim alleges that **onsemi** was negligent regarding the design or manufacture of the part. **onsemi** is an Equal Opportunity/Affirmative Action Employer. This literature is subject to all applicable copyright laws and is not for resale in any manner. Other names and brands may be claimed as the property of others.



ON Semiconductor®

FPF1007-FPF1009 IntelliMAX™ Advanced Load Products

Features

- 1.2 to 5.5 V Input Voltage Range
- Typical $R_{ON} = 30\text{ m}\Omega$ at $V_{IN} = 5.5\text{ V}$
- Typical $R_{ON} = 40\text{ m}\Omega$ at $V_{IN} = 3.3\text{ V}$
- Fixed Three Different Turn-on Rise Time $10\text{ }\mu\text{s} / 80\text{ }\mu\text{s} / 1\text{ ms}$
- Low $< 10\text{ }\mu\text{A}$ at $V_{IN} = 3.3\text{ V}$ Quiescent Current
- Internal ON Pin Pull Down
- Output Discharge Function
- ESD Protection above 8000 V HBM and 2000 V CDM
- RoHS Compliant

Applications

- PDAs
- Cell Phones
- GPS Devices
- MP3 Players
- Digital Cameras
- Peripheral Ports
- Hot-Swap Supplies
- Notebook Computers



General Description

The FPF1007/8/9 are low R_{DS} P-Channel MOSFET load switches offered in a selection of $10\text{ }\mu\text{s}$, $80\text{ }\mu\text{s}$, and 1 ms slew rate turn-on options for transient / in-rush current control. To support trends in mobile application requirements, the minimum operating input voltage has been reduced down to 1.2 V , the input current leakage has been minimized to extend battery life, and the ESD-protection has been designed to withstand a minimum of 8 kV (HBM) and 2 kV (CDM).

The switch is controlled by an active-high logic input (ON pin), allowing direct interface with a low-voltage control signal. An internal ON pin pull-down resistor protects against unintentional device turn-on in the initial state. An on-chip pull-down resistor on the output is enabled when the switch is turned-off and provides quick, robust discharge of the output load.

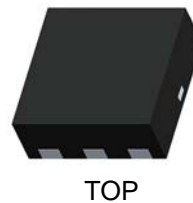
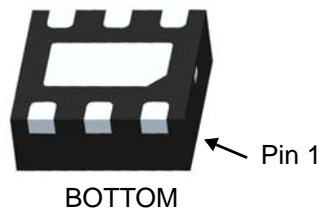

Ordering Information

Part	Switch R_{ON} at 5.5 V [Typ.]	Rise Time [Typ.]	Output Discharge [Typ.]	ON Pin Activity
FPF1007	$30\text{ m}\Omega$, PMOS	$10\text{ }\mu\text{s}$	$60\text{ }\Omega$	Active HIGH
FPF1008	$30\text{ m}\Omega$, PMOS	$80\text{ }\mu\text{s}$	$60\text{ }\Omega$	Active HIGH
FPF1009	$30\text{ m}\Omega$, PMOS	1 ms	$60\text{ }\Omega$	Active HIGH

Typical Application Circuit

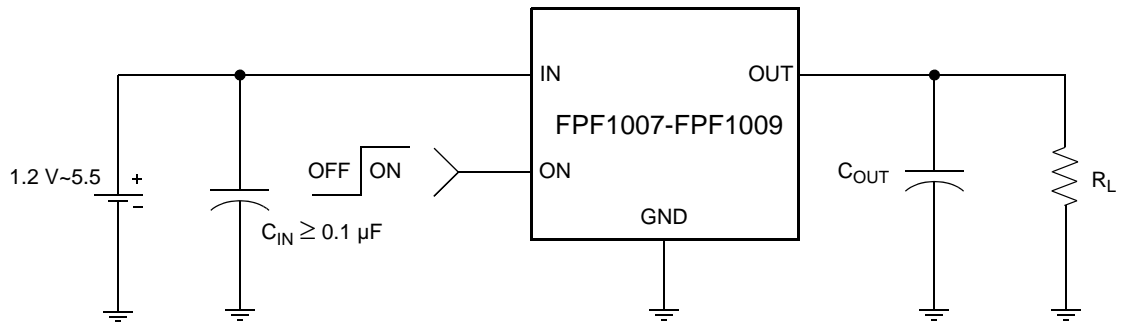

Functional Block Diagram

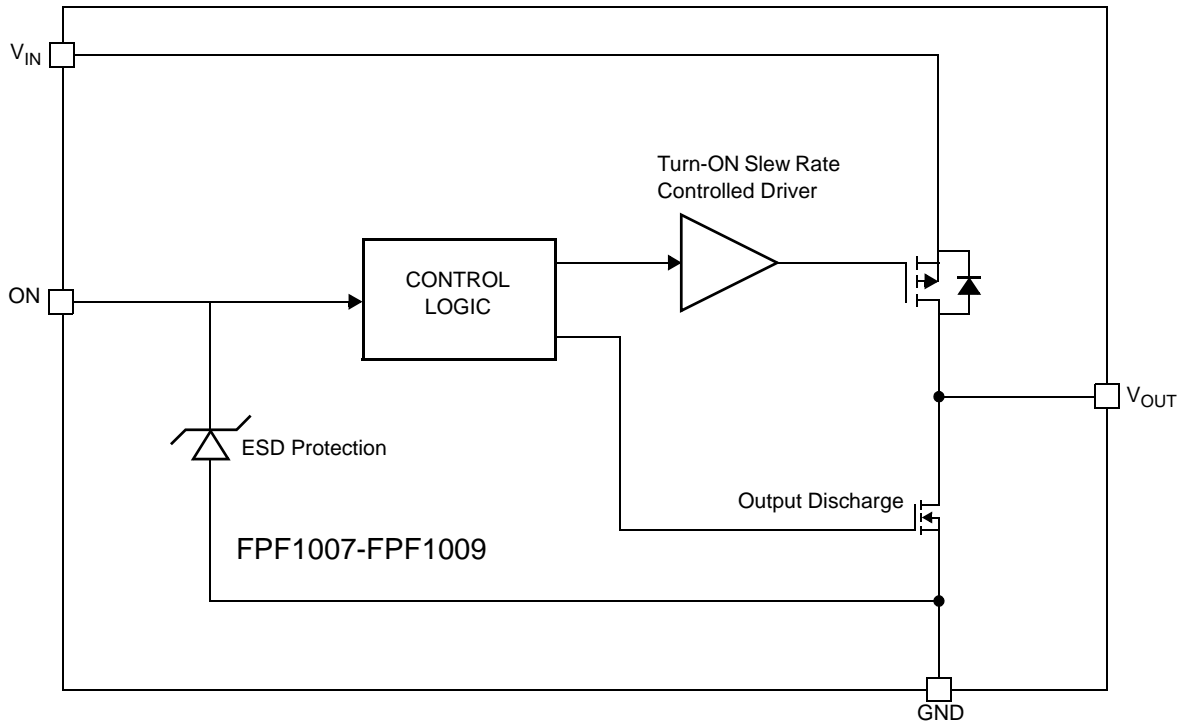

Pin Configuration

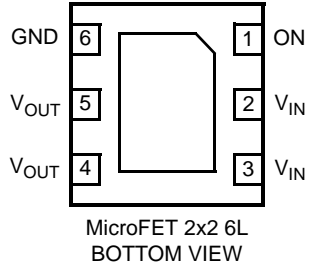

Pin Description

Pin	Name	Function
4, 5	V_{OUT}	Switch Output: Output of the power switch
2, 3	V_{IN}	Supply Input: Input to the power switch and the supply voltage for the IC
6	GND	Ground
1	ON	ON/OFF Control Input

Absolute Maximum Ratings

Parameter	Min.	Max.	Unit
V_{IN} , V_{OUT} , ON to GND	-0.3	6.0	V
Maximum Continuous Switch Current		1.5	A
Power Dissipation at $T_A = 25^\circ\text{C}^{(1)}$		1.2	W
Storage Junction Temperature	-65	+150	$^\circ\text{C}$
Operating Temperature Range	-40	+85	$^\circ\text{C}$
Thermal Resistance, Junction to Ambient		86	$^\circ\text{C/W}$
Electrostatic Discharge Protection	HBM	8000	V
	CDM	2000	V

Note:

Package power dissipation on 1-square inch pad, 2 oz. copper board.

Recommended Operating Range

Parameter	Min.	Max.	Unit
V_{IN}	1.2	5.5	V
Ambient Operating Temperature, T_A	-40	+85	$^\circ\text{C}$

Electrical Characteristics

$V_{IN} = 1.2\text{ V to } 5.5\text{ V}$, $T_A = -40\text{ to } +85^\circ\text{C}$ unless otherwise noted. Typical values are at $V_{IN} = 3.3\text{ V}$ and $T_A = 25^\circ\text{C}$.

Parameter	Symbol	Conditions	Min.	Typ.	Max.	Units
Basic Operation						
Operating Voltage	V_{IN}		1.2		5.5	V
Quiescent Current	I_Q	$I_{OUT} = 0\text{ mA}$, $V_{IN} = 3.3\text{ V}$, $V_{ON} = \text{Enabled}$		8		μA
		$I_{OUT} = 0\text{ mA}$, $V_{IN} = 5.5\text{ V}$, $V_{ON} = \text{Enabled}$			15	
Off Supply Current	$I_{Q(\text{off})}$	$V_{ON} = \text{GND}$, $V_{OUT} = \text{OPEN}$			1	μA
Off Switch Current	$I_{SD(\text{off})}$	$V_{ON} = \text{GND}$, $V_{OUT} = \text{GND}$		0.1	1.0	μA
On-Resistance	R_{ON}	$V_{IN} = 5.5\text{ V}$, $I_{OUT} = 200\text{ mA}$, $T_A = 25^\circ\text{C}$		30	40	$\text{m}\Omega$
		$V_{IN} = 3.3\text{ V}$, $I_{OUT} = 200\text{ mA}$, $T_A = 25^\circ\text{C}$		40	55	
		$V_{IN} = 1.5\text{ V}$, $I_{OUT} = 200\text{ mA}$, $T_A = 25^\circ\text{C}$		100	130	
		$V_{IN} = 1.2\text{ V}$, $I_{OUT} = 200\text{ mA}$, $T_A = 25^\circ\text{C}$		175	250	
		$V_{IN} = 3.3\text{ V}$, $I_{OUT} = 200\text{ mA}$, $T_A = -40^\circ\text{C to } +85^\circ\text{C}$	20		65	
Output Pull Down Resistance	R_{PD}	$V_{IN} = 3.3\text{ V}$, $V_{ON} = 0\text{ V}$, $T_A = 25^\circ\text{C}$		60		Ω
ON Input Logic Low Voltage	V_{IL}	$V_{IN} = 1.2\text{ V to } 5.5\text{ V}$			0.4	V
ON Input Logic High Voltage	V_{IH}	$V_{IN} = 1.2\text{ V to } 5.5\text{ V}$	1			V
ON Input Leakage (On)		$V_{ON} = V_{IN} = 5.5\text{ V}$			10	μA
ON Input Leakage (Off)		$V_{ON} = \text{GND}$			1	μA
Dynamic						
FPF1007						
Turn On	t_{ON}	$V_{IN} = 3.3\text{ V}$, $R_L = 500\ \Omega$, $R_{L_CHIP} = 60\ \Omega$, $C_{OUT} = 0.1\ \mu\text{F}$, $T_A = 25^\circ\text{C}$		12		μs
Rise Time	t_R			10		μs
Turn Off	t_{OFF}			40		μs
Fall Time	t_F			15		μs
FPF1008						
Turn On	t_{ON}	$V_{IN} = 3.3\text{ V}$, $R_L = 500\ \Omega$, $R_{L_CHIP} = 60\ \Omega$, $C_{OUT} = 0.1\ \mu\text{F}$, $T_A = 25^\circ\text{C}$		125		μs
Rise Time	t_R			80		μs
Turn Off	t_{OFF}			40		μs
Fall Time	t_F			15		μs
FPF1009						
Turn On	t_{ON}	$V_{IN} = 3.3\text{ V}$, $R_L = 500\ \Omega$, $R_{L_CHIP} = 60\ \Omega$, $C_{OUT} = 0.1\ \mu\text{F}$, $T_A = 25^\circ\text{C}$		2		ms
Rise Time	t_R			1		ms
Turn Off	t_{OFF}			40		μs
Fall Time	t_F			15		μs

Typical Characteristics

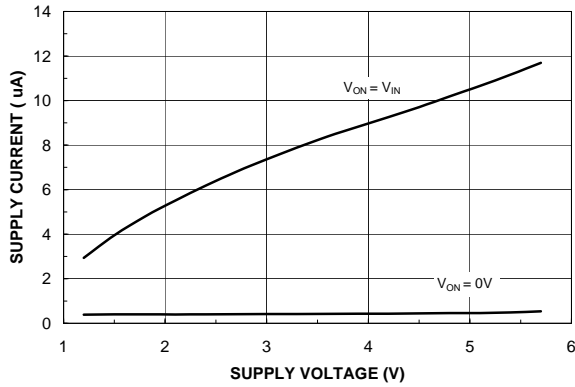

Figure 1. Quiescent Current vs. Input Voltage

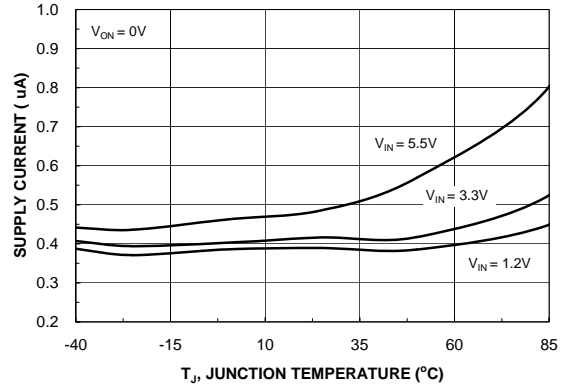

Figure 2. Quiescent Current vs. Temperature

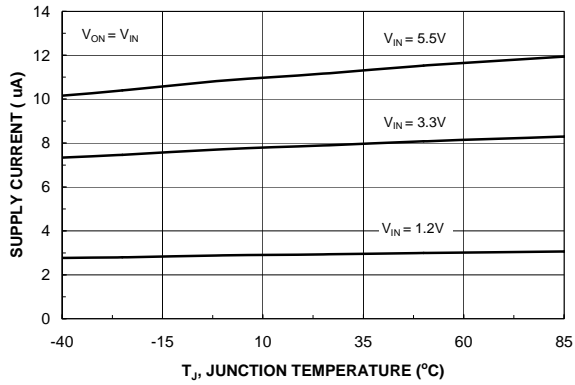

Figure 3. Quiescent Current vs. Temperature

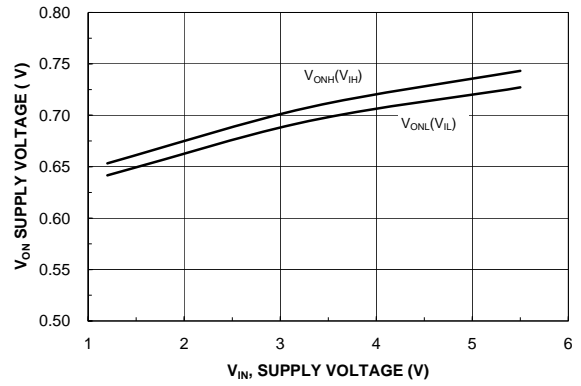

Figure 4. V_{ON} Voltage vs. Input Voltage

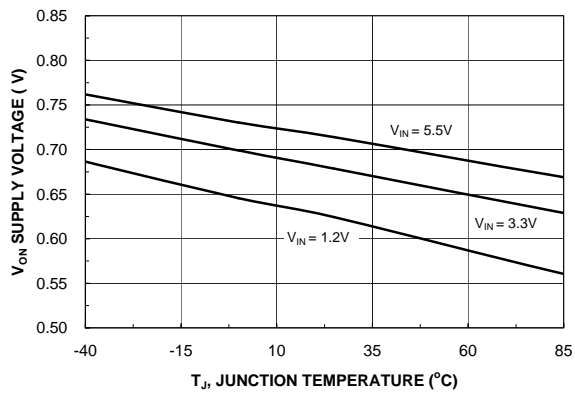

Figure 5. V_{ON} Low Voltage vs. Temperature

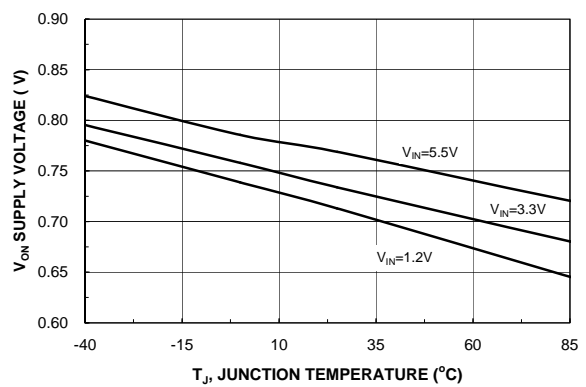

Figure 6. V_{ON} High Voltage vs. Temperature

Typical Characteristics

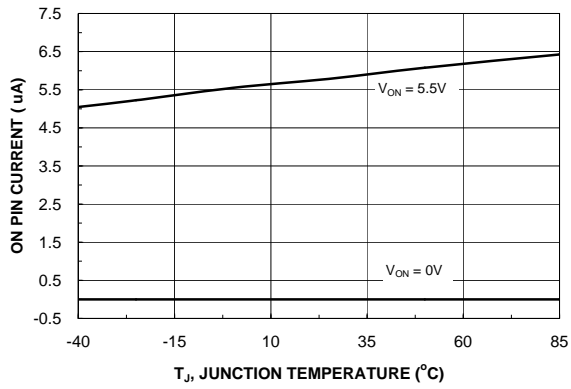

Figure 7. On Pin Current vs. Temperature

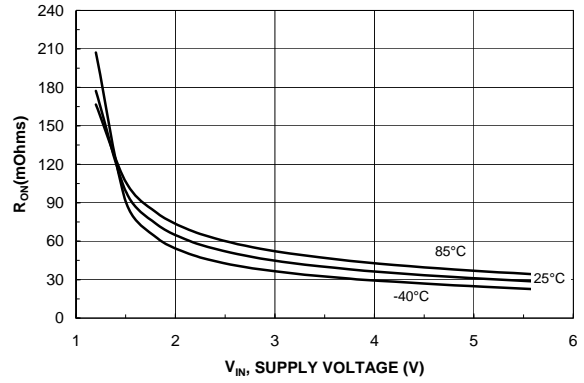

Figure 8. R_{ON} vs. V_{IN}

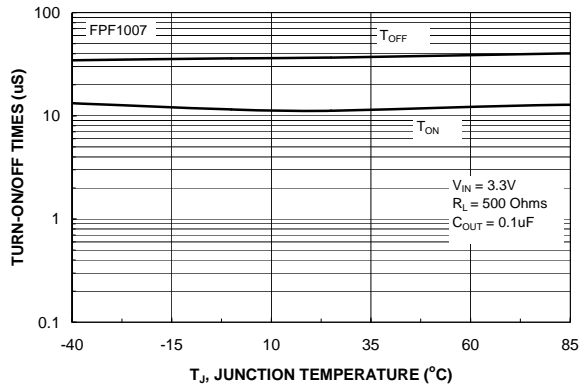

Figure 9. FPF1007 t_{ON} / t_{OFF} vs. Temperature

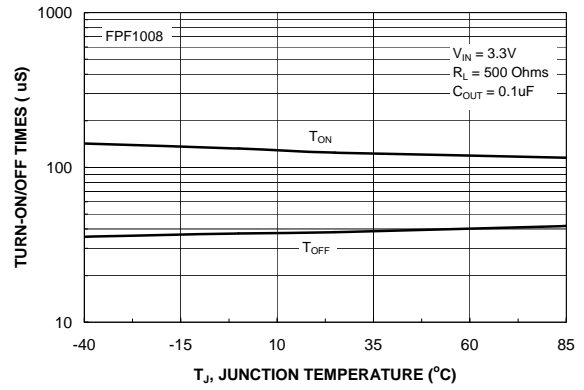

Figure 10. FPF1008 t_{ON} / t_{OFF} vs. Temperature

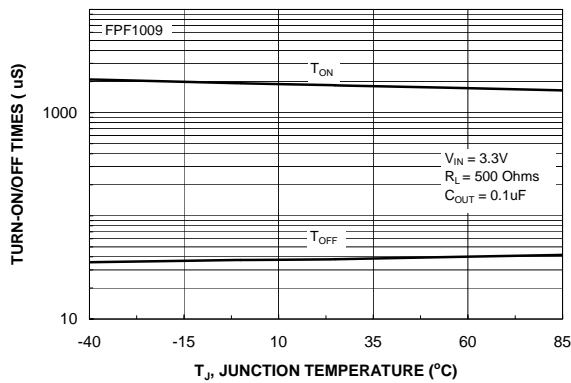

Figure 11. FPF1009 t_{ON} / t_{OFF} vs. Temperature

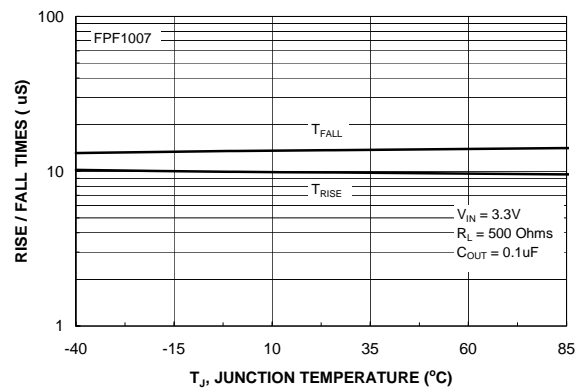

Figure 12. FPF1007 t_{RISE} / t_{FALL} vs. Temperature

Typical Characteristics

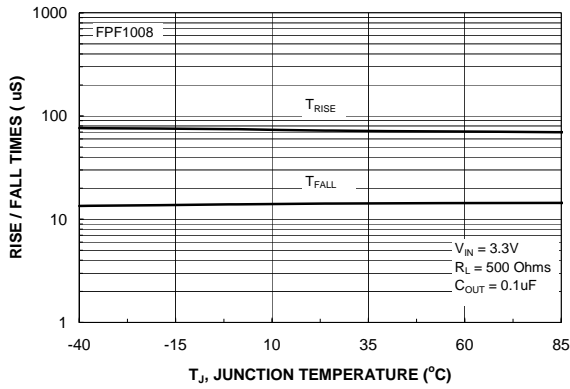

Figure 13. FPF1008 t_{RISE} / t_{FALL} vs. Temperature

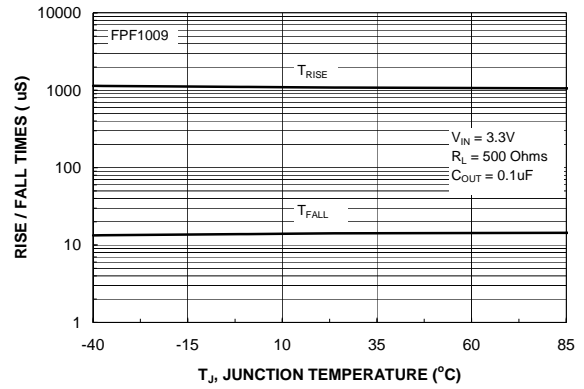

Figure 14. FPF1009 t_{RISE} / t_{FALL} vs. Temperature

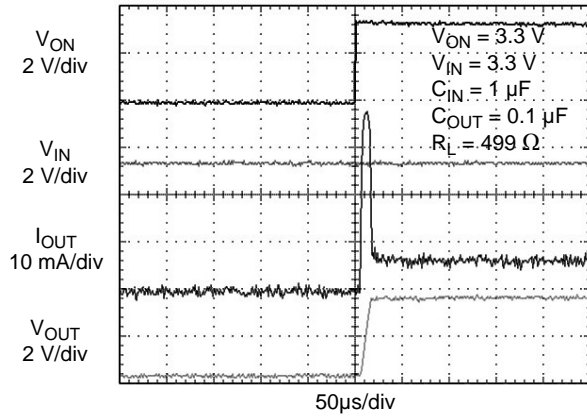

Figure 15. FPF1007 Turn-On Response

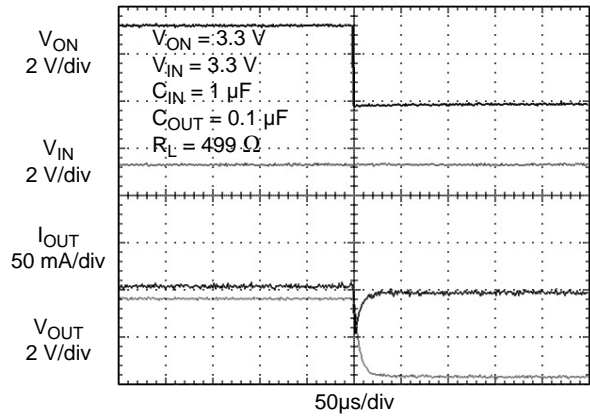

Figure 16. FPF1007 Turn-Off Response
Load current discharged through on-chip output discharge resistor

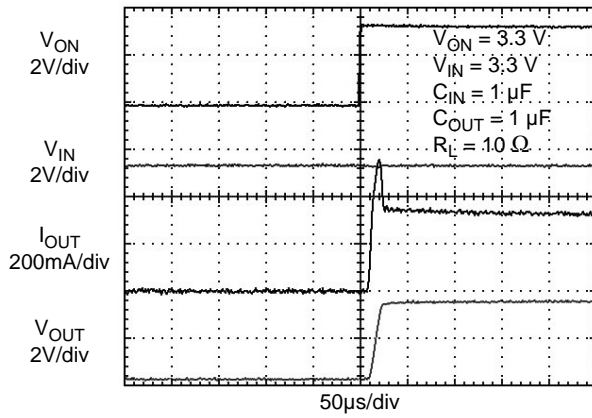

Figure 17. FPF1007 Turn-On Response ($C_{OUT} = 1 \mu F$)

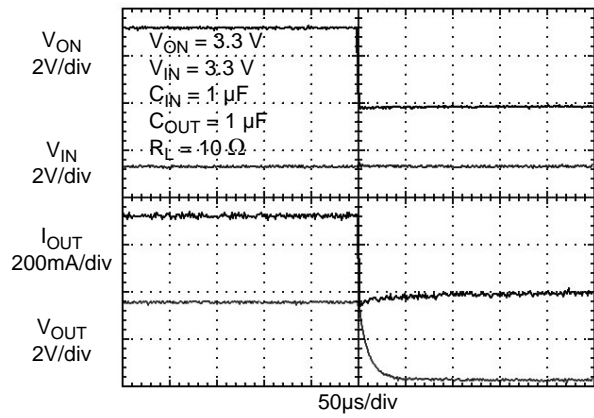

Figure 18. FPF1007 Turn-Off Response

Typical Characteristics

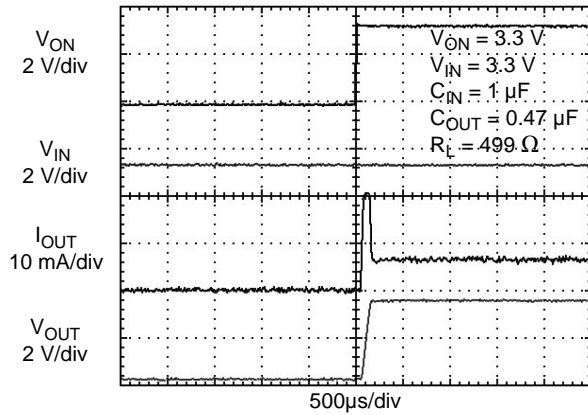

Figure 19. FPF1008 Turn-On Response

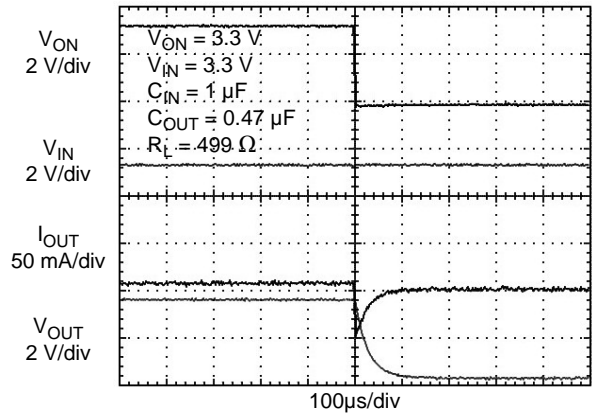

Figure 20. FPF1008 Turn-Off Response
Load current discharged through on-chip output discharge resistor

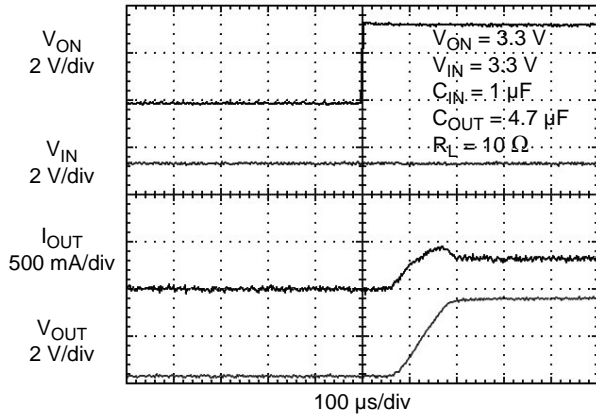

Figure 21. FPF1008 Turn-On Response ($C_{OUT} = 4.7\ \mu\text{F}$)

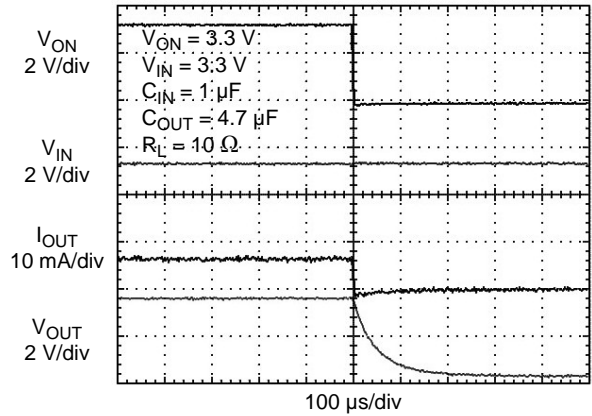

Figure 22. FPF1008 Turn-Off Response

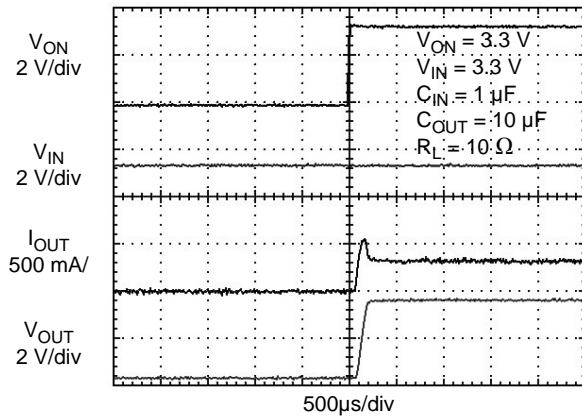

Figure 23. FPF1008 Turn-On Response ($C_{OUT} = 10\ \mu\text{F}$)

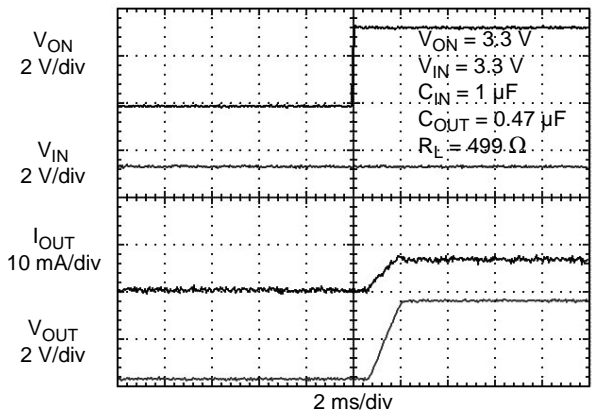

Figure 24. FPF1009 Turn-On Response

Typical Characteristics

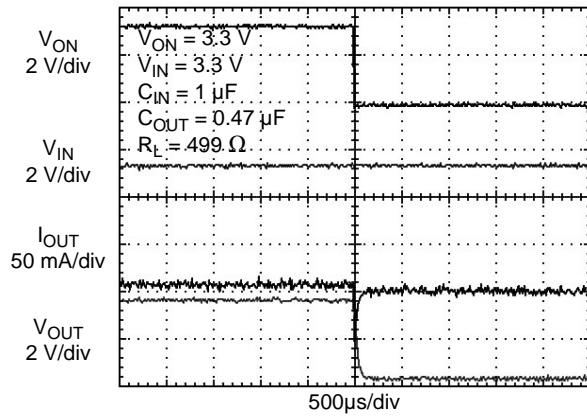

Figure 25. FPF1009 Turn-Off Response
Load current discharged through on-chip output discharge resistor

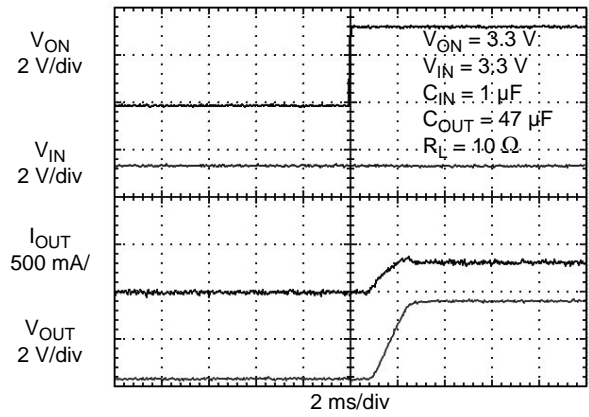

Figure 26. FPF1009 Turn-On Response ($C_{OUT} = 47 \mu\text{F}$)

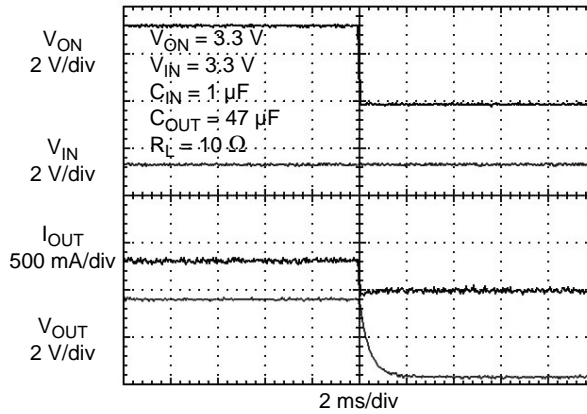

Figure 27. FPF1009 Turn-Off Response

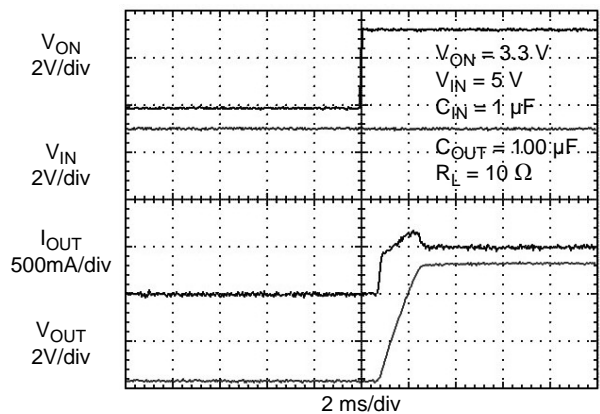
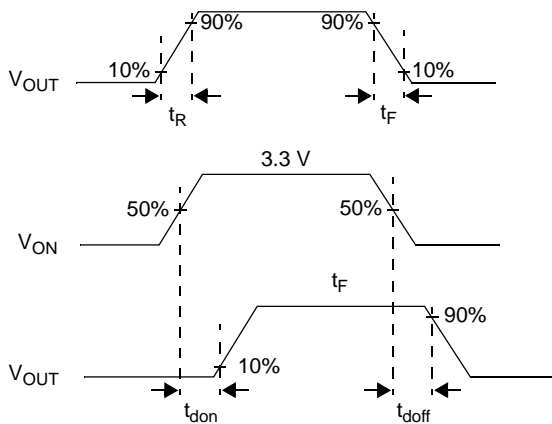

Figure 28. FPF1009 Turn-On Response
($C_{OUT} = 100 \mu\text{F}$, $V_{IN} = 5 \text{ V}$)

Timing Diagram



where:

- t_{ON} = Turn-On Time
- t_{OFF} = Turn-Off Time
- t_{don} = Turn-On Delay Time
- t_{doff} = Turn-Off Delay Time
- t_R = Rise Time
- t_F = V_{OUT} Fall Time
- $t_{ON} = t_R + t_{don}$
- $t_{OFF} = t_F + t_{doff}$

ON Semiconductor and  are trademarks of Semiconductor Components Industries, LLC dba ON Semiconductor or its subsidiaries in the United States and/or other countries. ON Semiconductor owns the rights to a number of patents, trademarks, copyrights, trade secrets, and other intellectual property. A listing of ON Semiconductor's product/patent coverage may be accessed at www.onsemi.com/site/pdf/Patent-Marking.pdf. ON Semiconductor reserves the right to make changes without further notice to any products herein. ON Semiconductor makes no warranty, representation or guarantee regarding the suitability of its products for any particular purpose, nor does ON Semiconductor assume any liability arising out of the application or use of any product or circuit, and specifically disclaims any and all liability, including without limitation special, consequential or incidental damages. Buyer is responsible for its products and applications using ON Semiconductor products, including compliance with all laws, regulations and safety requirements or standards, regardless of any support or applications information provided by ON Semiconductor. "Typical" parameters which may be provided in ON Semiconductor data sheets and/or specifications can and do vary in different applications and actual performance may vary over time. All operating parameters, including "Typicals" must be validated for each customer application by customer's technical experts. ON Semiconductor does not convey any license under its patent rights nor the rights of others. ON Semiconductor products are not designed, intended, or authorized for use as a critical component in life support systems or any FDA Class 3 medical devices or medical devices with a same or similar classification in a foreign jurisdiction or any devices intended for implantation in the human body. Should Buyer purchase or use ON Semiconductor products for any such unintended or unauthorized application, Buyer shall indemnify and hold ON Semiconductor and its officers, employees, subsidiaries, affiliates, and distributors harmless against all claims, costs, damages, and expenses, and reasonable attorney fees arising out of, directly or indirectly, any claim of personal injury or death associated with such unintended or unauthorized use, even if such claim alleges that ON Semiconductor was negligent regarding the design or manufacture of the part. ON Semiconductor is an Equal Opportunity/Affirmative Action Employer. This literature is subject to all applicable copyright laws and is not for resale in any manner.

PUBLICATION ORDERING INFORMATION

LITERATURE FULFILLMENT:

Literature Distribution Center for ON Semiconductor
19521 E. 32nd Pkwy, Aurora, Colorado 80011 USA
Phone: 303-675-2175 or 800-344-3860 Toll Free USA/Canada
Fax: 303-675-2176 or 800-344-3867 Toll Free USA/Canada
Email: orderlit@onsemi.com

N. American Technical Support: 800-282-9855 Toll Free
USA/Canada
Europe, Middle East and Africa Technical Support:
Phone: 421 33 790 2910
Japan Customer Focus Center
Phone: 81-3-5817-1050

ON Semiconductor Website: www.onsemi.com
Order Literature: <http://www.onsemi.com/orderlit>
For additional information, please contact your local
Sales Representative