



Is Now Part of



ON Semiconductor®

To learn more about ON Semiconductor, please visit our website at
www.onsemi.com

ON Semiconductor and the ON Semiconductor logo are trademarks of Semiconductor Components Industries, LLC dba ON Semiconductor or its subsidiaries in the United States and/or other countries. ON Semiconductor owns the rights to a number of patents, trademarks, copyrights, trade secrets, and other intellectual property. A listing of ON Semiconductor's product/patent coverage may be accessed at www.onsemi.com/site/pdf/Patent-Marking.pdf. ON Semiconductor reserves the right to make changes without further notice to any products herein. ON Semiconductor makes no warranty, representation or guarantee regarding the suitability of its products for any particular purpose, nor does ON Semiconductor assume any liability arising out of the application or use of any product or circuit, and specifically disclaims any and all liability, including without limitation special, consequential or incidental damages. Buyer is responsible for its products and applications using ON Semiconductor products, including compliance with all laws, regulations and safety requirements or standards, regardless of any support or applications information provided by ON Semiconductor. "Typical" parameters which may be provided in ON Semiconductor data sheets and/or specifications can and do vary in different applications and actual performance may vary over time. All operating parameters, including "Typicals" must be validated for each customer application by customer's technical experts. ON Semiconductor does not convey any license under its patent rights nor the rights of others. ON Semiconductor products are not designed, intended, or authorized for use as a critical component in life support systems or any FDA Class 3 medical devices or medical devices with a same or similar classification in a foreign jurisdiction or any devices intended for implantation in the human body. Should Buyer purchase or use ON Semiconductor products for any such unintended or unauthorized application, Buyer shall indemnify and hold ON Semiconductor and its officers, employees, subsidiaries, affiliates, and distributors harmless against all claims, costs, damages, and expenses, and reasonable attorney fees arising out of, directly or indirectly, any claim of personal injury or death associated with such unintended or unauthorized use, even if such claim alleges that ON Semiconductor was negligent regarding the design or manufacture of the part. ON Semiconductor is an Equal Opportunity/Affirmative Action Employer. This literature is subject to all applicable copyright laws and is not for resale in any manner.



November 2015

FODM121 Series, FODM124, FODM2701, FODM2705 4-Pin Full Pitch Mini-Flat Package Phototransistor Optocouplers

Features

- More than 5 mm Creepage/Clearance
- Compact 4-Pin Surface Mount Package (2.4 mm Maximum Standoff Height)
- Current Transfer Ratio in Selected Groups:
 - DC Input:
 - FODM121: 50–600%
 - FODM121A: 100–300%
 - FODM121B: 50–150%
 - FODM121C: 100–200%
 - FODM124: 100% MIN
 - FODM2701: 50–300%
 - AC Input:
 - FODM2705: 50–300%
- Safety and Regulatory Approvals:
 - UL1577, 3,750 VAC_{RMS} for 1 Minute
 - DIN-EN/IEC60747-5-5, 565 V Peak Working Insulation Voltage

Applications

- Digital Logic Inputs
- Microprocessor Inputs
- Power Supply Monitor
- Twisted Pair Line Receiver
- Telephone Line Receiver

Description

The FODM121 series, FODM124, and FODM2701 consists of a gallium arsenide infrared emitting diode driving a phototransistor in a compact 4-pin mini-flat package. The lead pitch is 2.54 mm. The FODM2705 consists of two gallium arsenide infrared emitting diodes connected in inverse parallel for AC operation.

Functional Block Diagram

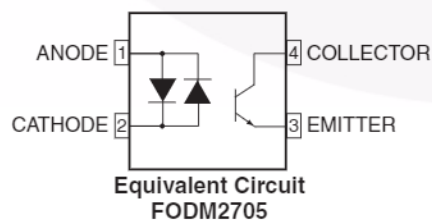
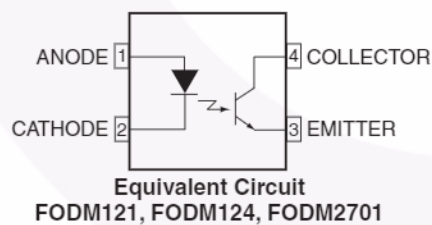

Figure 1. Schematic

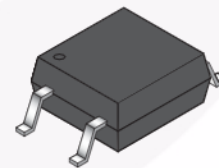

Figure 2. Package Outlines

Safety and Insulation Ratings

As per DIN EN/IEC 60747-5-5, this optocoupler is suitable for “safe electrical insulation” only within the safety limit data. Compliance with the safety ratings shall be ensured by means of protective circuits.

Parameter		Characteristics
Installation Classifications per DIN VDE 0110/1.89 Table 1, For Rated Mains Voltage	< 150 V _{RMS}	I–IV
	< 300 V _{RMS}	I–III
Climatic Classification		40/110/21
Pollution Degree (DIN VDE 0110/1.89)		2
Comparative Tracking Index		175

Symbol	Parameter	Value	Unit
V _{PR}	Input-to-Output Test Voltage, Method A, V _{IORM} × 1.6 = V _{PR} , Type and Sample Test with t _m = 10 s, Partial Discharge < 5 pC	904	V _{peak}
	Input-to-Output Test Voltage, Method B, V _{IORM} × 1.875 = V _{PR} , 100% Production Test with t _m = 1 s, Partial Discharge < 5 pC	1060	V _{peak}
V _{IORM}	Maximum Working Insulation Voltage	565	V _{peak}
V _{IOTM}	Highest Allowable Over-Voltage	6000	V _{peak}
	External Creepage	≥ 5	mm
	External Clearance	≥ 5	mm
DTI	Distance Through Insulation (Insulation Thickness)	≥ 0.4	mm
T _S	Case Temperature ⁽¹⁾	150	°C
I _{S,INPUT}	Input Current ⁽¹⁾	200	mA
P _{S,OUTPUT}	Output Power ⁽¹⁾	300	mW
R _{IO}	Insulation Resistance at T _S , V _{IO} = 500 V ⁽¹⁾	> 10 ⁹	Ω

Note:

1. Safety limit values – maximum values allowed in the event of a failure.

Absolute Maximum Ratings

Stresses exceeding the absolute maximum ratings may damage the device. The device may not function or be operable above the recommended operating conditions and stressing the parts to these levels is not recommended. In addition, extended exposure to stresses above the recommended operating conditions may affect device reliability. The absolute maximum ratings are stress ratings only. $T_A = 25^\circ\text{C}$ Unless otherwise specified.

Symbol	Parameter	Value	Unit
TOTAL PACKAGE			
T_{STG}	Storage Temperature	-40 to +125	$^\circ\text{C}$
T_{OPR}	Operating Temperature	-40 to +110	$^\circ\text{C}$
T_J	Junction Temperature	-40 to +125	$^\circ\text{C}$
T_{SOL}	Lead Solder Temperature	260 for 10 sec	$^\circ\text{C}$
EMITTER			
$I_F (avg)$	Continuous Forward Current	50	mA
$I_F (pk)$	Peak Forward Current (1 μs pulse, 300 pps.)	1	A
V_R	Reverse Voltage	6	V
P_D	Power Dissipation	70	mW
	Derate linearly (Above 75°C)	1.41	$\text{mW}/^\circ\text{C}$
DETECTOR			
I_C	Continuous Collector Current	80	mA
V_{CEO}	Collector-Emitter Voltage	FODM121 Series, FODM124	80
		FODM2701, FODM2705	40
V_{ECO}	Emitter-Collector Voltage	6	V
P_D	Power Dissipation	150	mW
	Derate linearly (Above 80°C)	3.27	$\text{mW}/^\circ\text{C}$

Electrical Characteristics

$T_A = 25^\circ\text{C}$ unless otherwise specified.

Symbol	Parameter	Device	Test Conditions	Min.	Typ.	Max.	Unit
INDIVIDUAL COMPONENT CHARACTERISTICS							
Emitter							
V_F	Forward Voltage	FODM121 Series, FODM124	$I_F = 10\text{ mA}$	1.0		1.3	V
		FODM2701	$I_F = 5\text{ mA}$			1.4	
		FODM2705	$I_F = \pm 5\text{ mA}$				
I_R	Reverse Current	FODM121 Series, FODM124, FODM2701	$V_R = 5\text{ V}$			5	μA
Detector							
BV_{CEO}	Collector-Emitter Breakdown Voltage	FODM121 Series, FODM124	$I_C = 1\text{ mA}, I_F = 0$	80			V
		FODM2701, FODM2705		40			
BV_{ECO}	Emitter-Collector Breakdown Voltage	All	$I_E = 100\text{ }\mu\text{A}, I_F = 0$	7			V
I_{CEO}	Collector Dark Current	All	$V_{CE} = 40\text{ V}, I_F = 0$			100	nA
C_{CE}	Capacitance	All	$V_{CE} = 0\text{ V}, f = 1\text{ MHz}$		10		pF
TRANSFER CHARACTERISTICS							
CTR	DC Current Transfer Ratio	FODM2701	$I_F = 5\text{ mA}, V_{CE} = 5\text{ V}$	50		300	%
		FODM2705	$I_F = \pm 5\text{ mA}, V_{CE} = 5\text{ V}$	50		300	
		FODM121	$I_F = 5\text{ mA}, V_{CE} = 5\text{ V}$	50		600	
		FODM121A		100		300	
		FODM121B		50		150	
		FODM121C		100		200	
		FODM124	$I_F = 1\text{ mA}, V_{CE} = 0.5\text{ V}$	100		1200	
	$I_F = 0.5\text{ mA}, V_{CE} = 1.5\text{ V}$	50					
	CTR Symmetry	FODM2705	$I_F = \pm 5\text{ mA}, V_{CE} = 5\text{ V}$	0.3		3.0	
$V_{CE(SAT)}$	Saturation Voltage	FODM121 Series	$I_F = 8\text{ mA}, I_C = 2.4\text{ mA}$			0.4	V
		FODM124	$I_F = 1\text{ mA}, I_C = 0.5\text{ mA}$			0.4	
		FODM2701	$I_F = 10\text{ mA}, I_C = 2\text{ mA}$			0.3	
		FODM2705	$I_F = \pm 10\text{ mA}, I_C = 2\text{ mA}$			0.3	
t_r	Rise Time (Non-Saturated)	All	$I_C = 2\text{ mA}, V_{CE} = 5\text{ V}, R_L = 100\text{ }\Omega$		3		μs
t_f	Fall Time (Non-Saturated)	All	$I_C = 2\text{ mA}, V_{CE} = 5\text{ V}, R_L = 100\text{ }\Omega$		3		μs
ISOLATION CHARACTERISTICS							
V_{ISO}	Steady State Isolation Voltage ⁽²⁾	All	1 minute	3750			$V_{AC_{RMS}}$

Note:

- Steady state isolation voltage, V_{ISO} , is an internal device dielectric breakdown rating. For this test, pins 1 and 2 are common, and pins 3 and 4 are common.

Typical Performance Curves

$T_A = 25^\circ\text{C}$ unless otherwise specified.

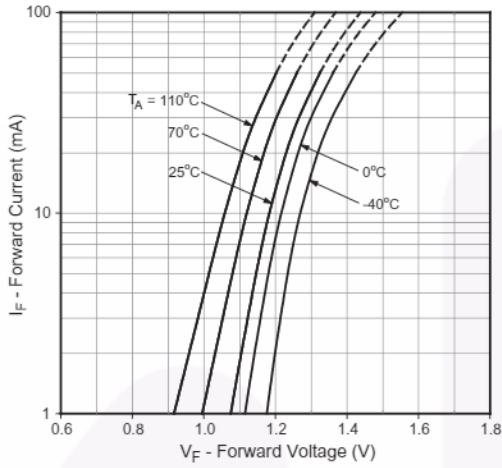

Fig. 3 Forward Current vs. Forward Voltage

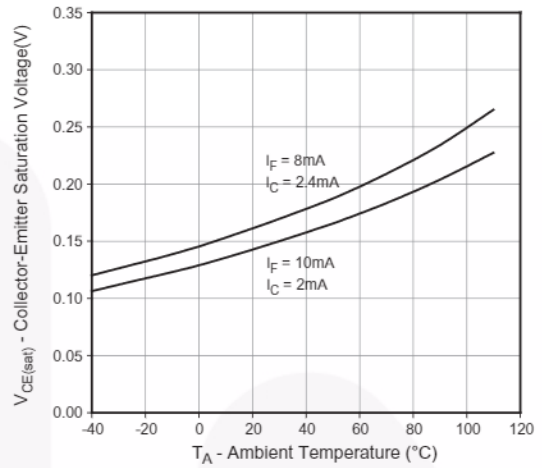

Fig. 4 Collector-Emitter Saturation Voltage vs. Ambient Temperature (FODM121/2701/2705)

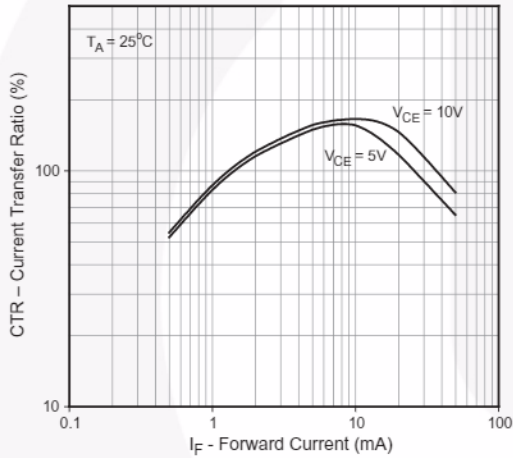

Fig. 5 Current Transfer Ratio vs. Forward Current (FODM121/2701/2705)

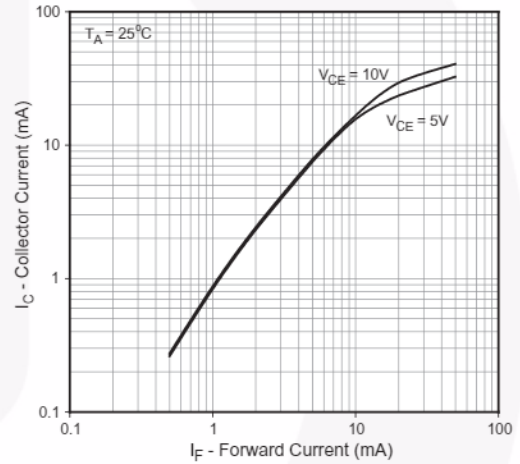

Fig. 6 Collector Current vs. Forward Current (FODM121/2701/2705)

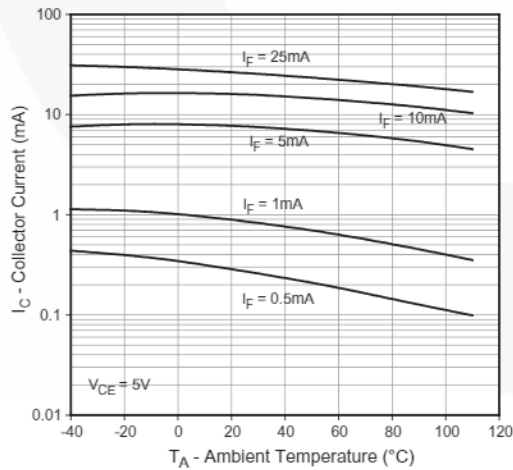

Fig. 7 Collector Current vs. Ambient Temperature (FODM121/2701/2705)

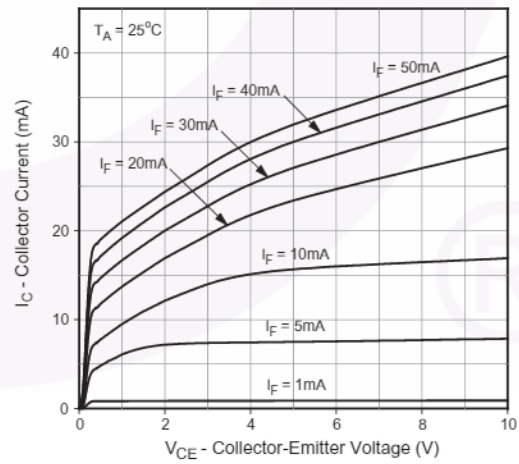

Fig. 8 Collector Current vs. Collector-Emitter Voltage (FODM121/2701/2705)

Typical Performance Curves (Continued)

$T_A = 25^\circ\text{C}$ unless otherwise specified.

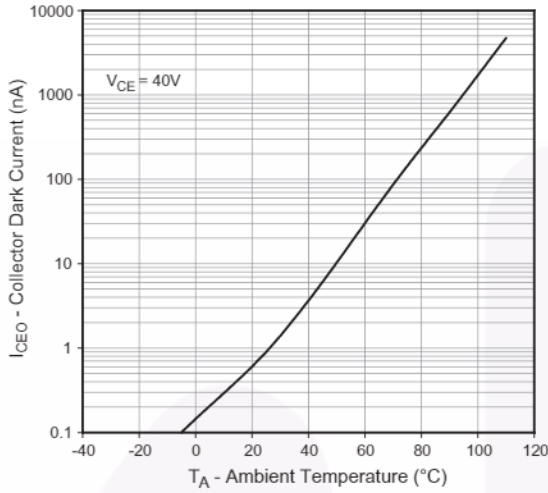

Fig 9. Collector Dark Current vs. Ambient Temperature (FODM121/2701/2705)

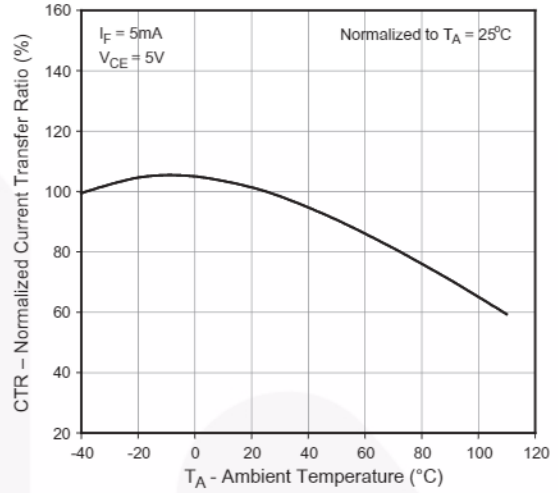

Fig 10. Normalized Current Transfer Ratio vs. Ambient Temperature (FODM121/2701/2705)

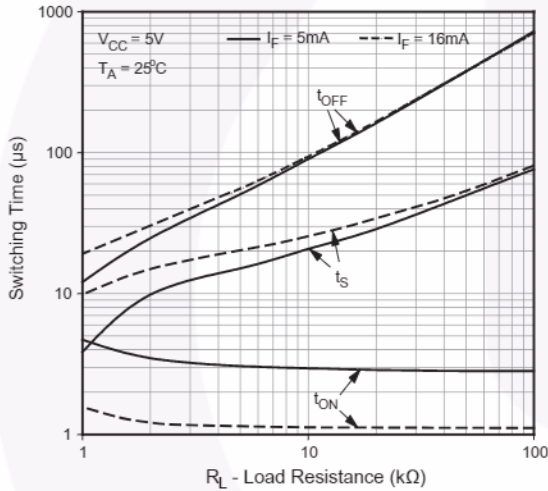

Fig 11. Switching Time vs. Load Resistance (FODM121/2701/2705)

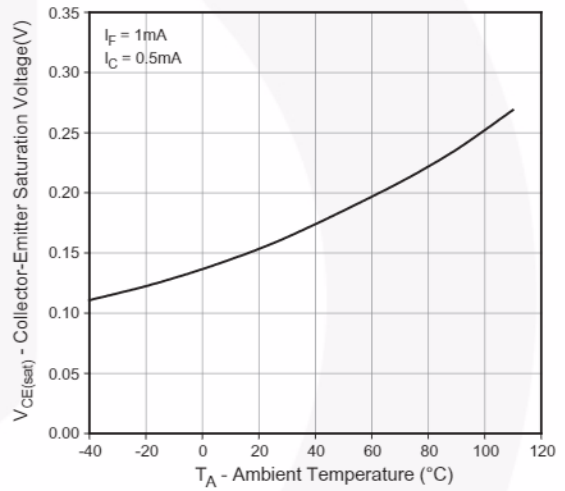

Fig 12. Collector-Emitter Saturation Voltage vs. Ambient Temperature (FODM124)

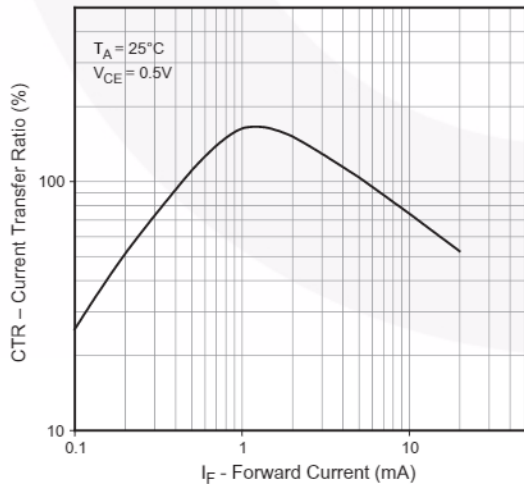

Fig 13. Current Transfer Ratio vs. Forward Current (FODM124)

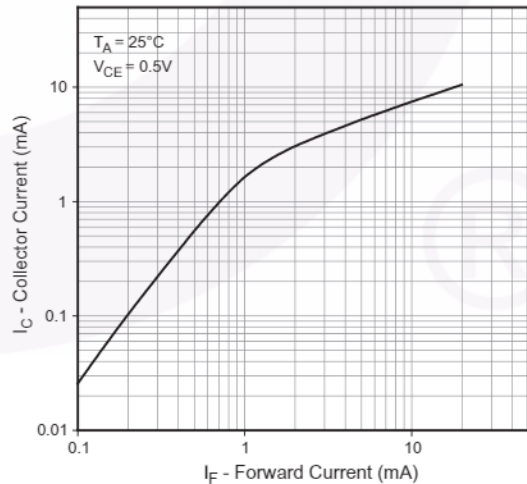

Fig 14. Collector Current vs. Forward Current (FODM124)

Typical Performance Curves (Continued)

$T_A = 25^\circ\text{C}$ unless otherwise specified.

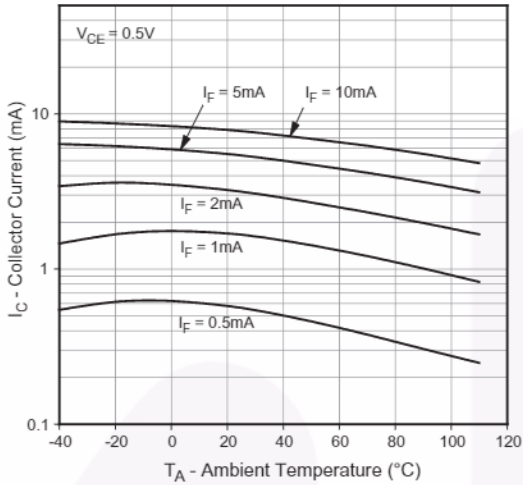

Fig. 15. Collector Current vs. Ambient Temperature (FODM124)

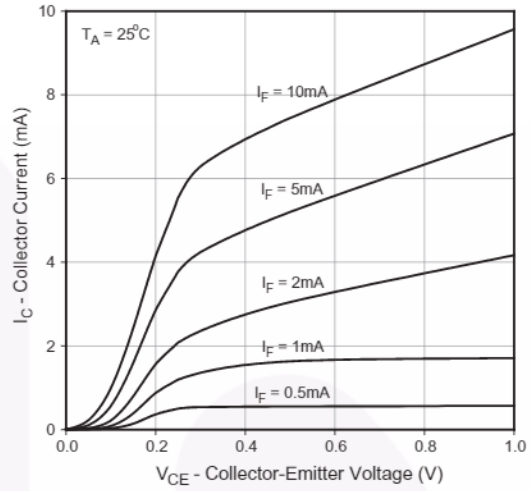

Fig. 16. Collector Current vs. Collector-Emitter Voltage (FODM124)

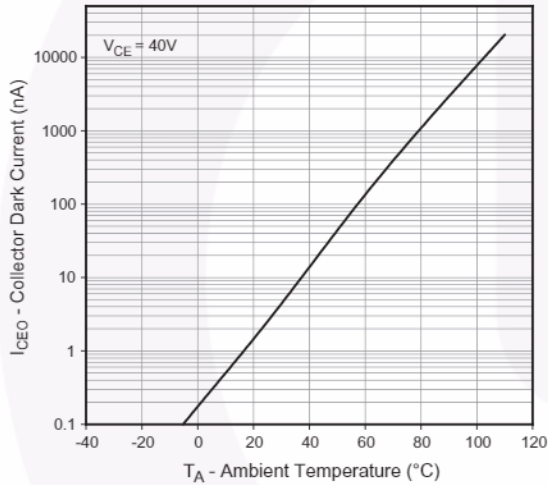

Fig. 17. Collector Dark Current vs. Ambient Temperature (FODM124)

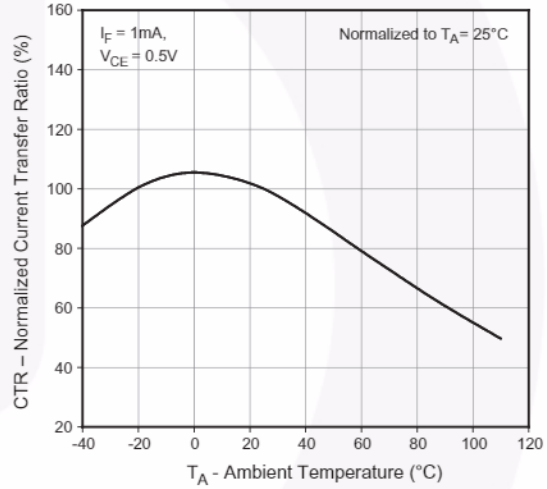

Fig. 18. Normalized Current Transfer Ratio vs. Ambient Temperature (FODM124)

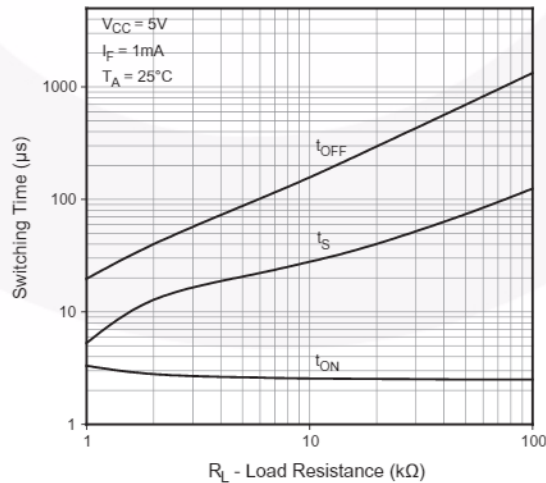
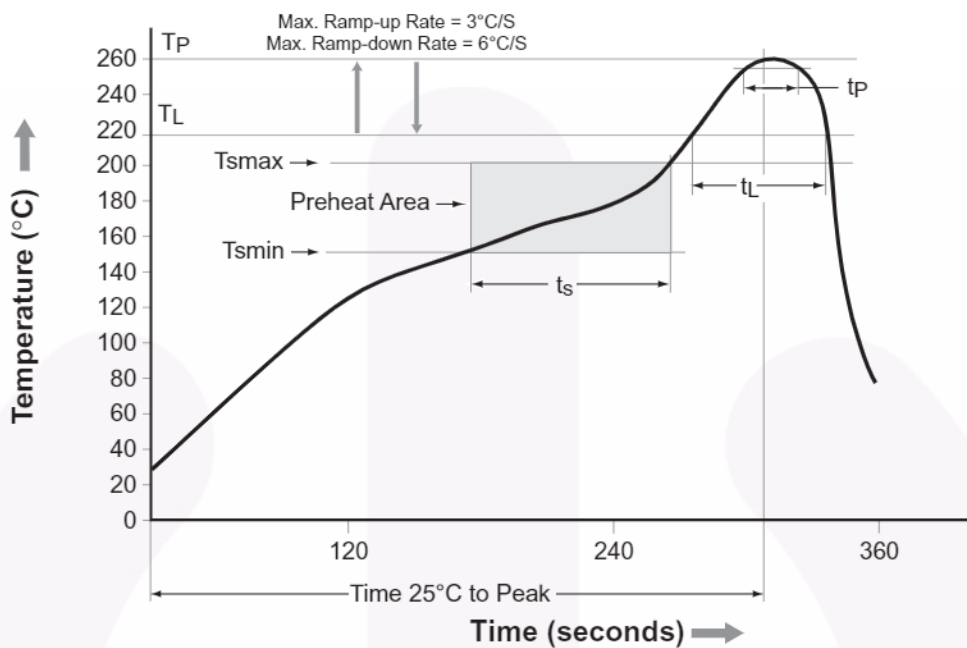

Fig. 19. Switching Time vs. Load Resistance (FODM124)

Reflow Profile



Profile Feature	Pb-Free Assembly Profile
Temperature Min. (Tsmín)	150°C
Temperature Max. (Tsmáx)	200°C
Time (ts) from (Tsmín to Tsmáx)	60–120 seconds
Ramp-up Rate (tL to tp)	3°C/second max.
Liquidous Temperature (TL)	217°C
Time (tL) Maintained Above (TL)	60–150 seconds
Peak Body Package Temperature	260°C +0°C / -5°C
Time (tp) within 5°C of 260°C	30 seconds
Ramp-down Rate (TP to TL)	6°C/second max.
Time 25°C to Peak Temperature	8 minutes max.



Ordering Information

Part Number	Package	Packing Method
FODM121	Full Pitch Mini-Flat 4-Pin	Tube (100 units)
FODM121R2	Full Pitch Mini-Flat 4-Pin	Tape and Reel (2500 Units)
FODM121V	Full Pitch Mini-Flat 4-Pin, DIN EN/IEC60747-5-5 Option	Tube (100 Units)
FODM121R2V	Full Pitch Mini-Flat 4-Pin, DIN EN/IEC60747-5-5 Option	Tape and Reel (2500 Units)

Note:

The product orderable part number system listed in this table also applies to the FODM121A, FODM121B, FODM121C, FODM124, FODM2701, and FODM2705 products.

Marking Information

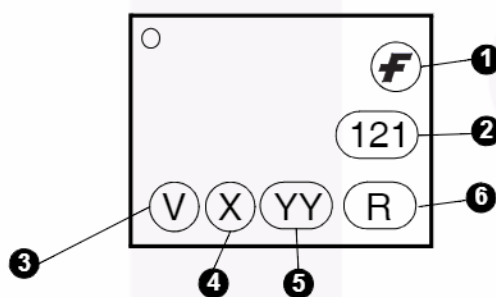
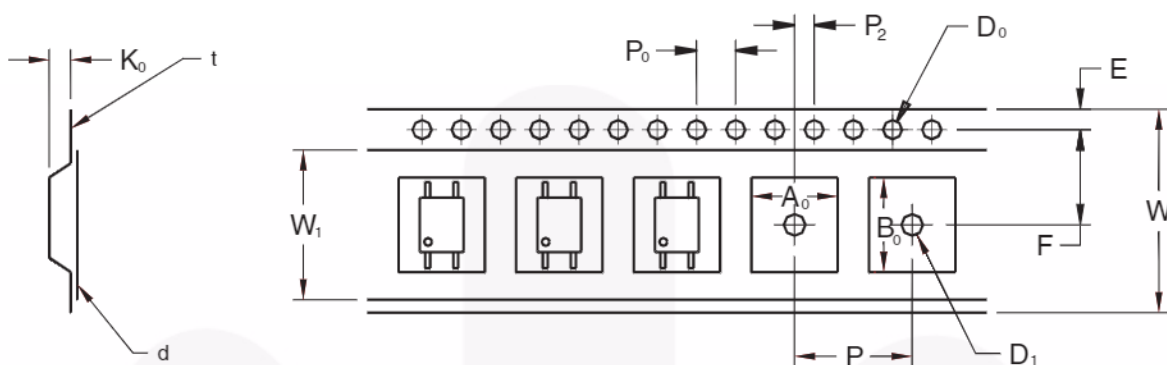

Figure 20. Top Mark

Table 1. Top Mark Definitions

1	Fairchild Logo
2	Device Number
3	DIN EN/IEC60747-5-5 Option (only appears on component ordered with this option)
4	One-Digit Year Code, e.g., "5"
5	Digit Work Week, Ranging from "01" to "53"
6	Assembly Package Code

Carrier Tape Specifications



		2.54 Pitch
Description	Symbol	Dimensions
Tape Width	W	12.00±0.4
Tape Thickness	t	0.35±0.02
Sprocket Hole Pitch	P ₀	4.00±0.20
Sprocket Hole Dia.	D ₀	1.55±0.20
Sprocket Hole Location	E	1.75±0.20
Pocket Location	F	5.50±0.20
	P ₂	2.00±0.20
Pocket Pitch	P	8.00±0.20
Pocket Dimension	A ₀	4.75±0.20
	B ₀	7.30±0.20
	K ₀	2.30±0.20
Pocket Hole Dia.	D ₁	1.55±0.20
Cover Tape Width	W ₁	9.20
Cover Tape Thickness	d	0.065±0.02
Max. Component Rotation or Tilt		20° max
Devices Per Reel		2500
Reel Diameter		330 mm (13")

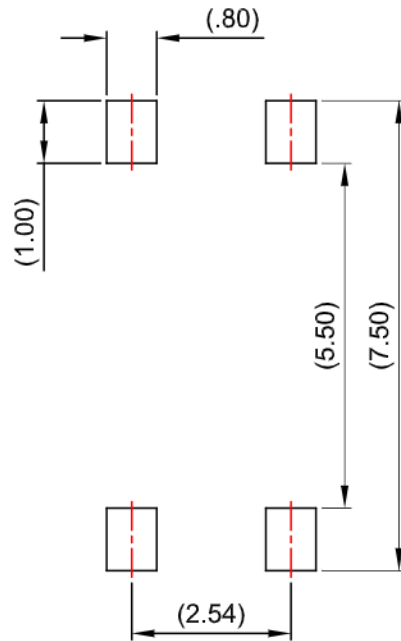
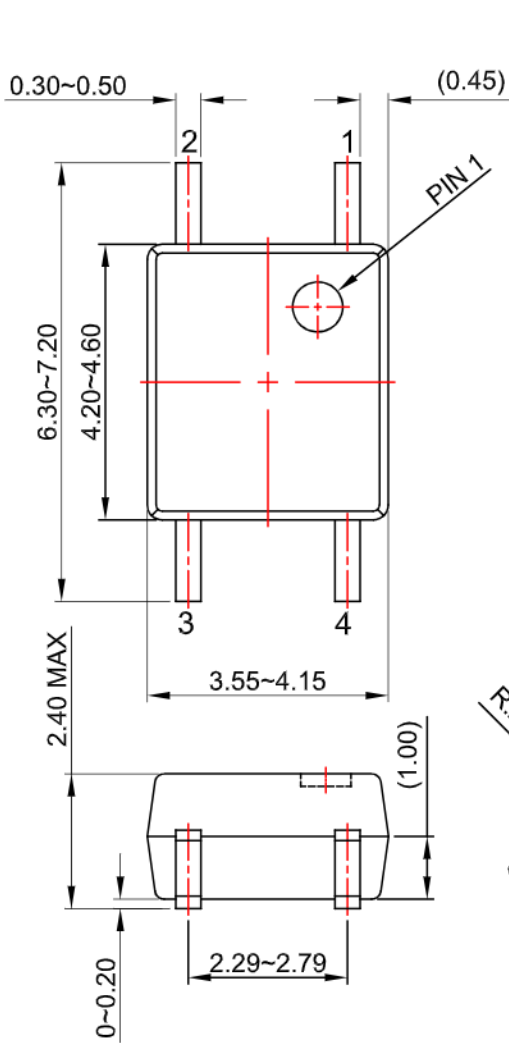

LAND PATTERN RECOMMENDATION

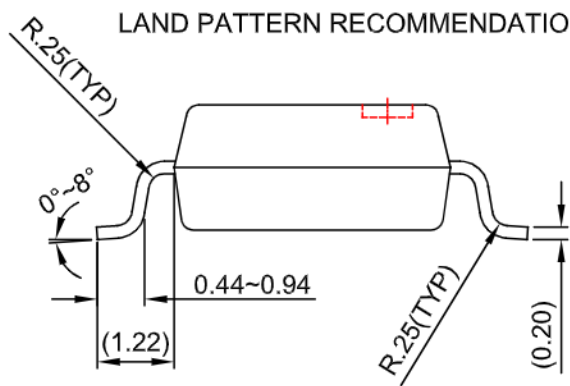

NOTES:

- A) NO STANDARD APPLIES TO THIS PACKAGE.
- B) ALL DIMENSIONS ARE IN MILLIMETERS.
- C) DIMENSIONS ARE EXCLUSIVE OF BURRS, MOLD FLASH, AND TIE BAR EXTRUSION
- D) DRAWING FILENAME AND REVISION: MKT-MFP04Crev3.



ON Semiconductor and  are trademarks of Semiconductor Components Industries, LLC dba ON Semiconductor or its subsidiaries in the United States and/or other countries. ON Semiconductor owns the rights to a number of patents, trademarks, copyrights, trade secrets, and other intellectual property. A listing of ON Semiconductor's product/patent coverage may be accessed at www.onsemi.com/site/pdf/Patent-Marking.pdf. ON Semiconductor reserves the right to make changes without further notice to any products herein. ON Semiconductor makes no warranty, representation or guarantee regarding the suitability of its products for any particular purpose, nor does ON Semiconductor assume any liability arising out of the application or use of any product or circuit, and specifically disclaims any and all liability, including without limitation special, consequential or incidental damages. Buyer is responsible for its products and applications using ON Semiconductor products, including compliance with all laws, regulations and safety requirements or standards, regardless of any support or applications information provided by ON Semiconductor. "Typical" parameters which may be provided in ON Semiconductor data sheets and/or specifications can and do vary in different applications and actual performance may vary over time. All operating parameters, including "Typicals" must be validated for each customer application by customer's technical experts. ON Semiconductor does not convey any license under its patent rights nor the rights of others. ON Semiconductor products are not designed, intended, or authorized for use as a critical component in life support systems or any FDA Class 3 medical devices or medical devices with a same or similar classification in a foreign jurisdiction or any devices intended for implantation in the human body. Should Buyer purchase or use ON Semiconductor products for any such unintended or unauthorized application, Buyer shall indemnify and hold ON Semiconductor and its officers, employees, subsidiaries, affiliates, and distributors harmless against all claims, costs, damages, and expenses, and reasonable attorney fees arising out of, directly or indirectly, any claim of personal injury or death associated with such unintended or unauthorized use, even if such claim alleges that ON Semiconductor was negligent regarding the design or manufacture of the part. ON Semiconductor is an Equal Opportunity/Affirmative Action Employer. This literature is subject to all applicable copyright laws and is not for resale in any manner.

PUBLICATION ORDERING INFORMATION

LITERATURE FULFILLMENT

Literature Distribution Center for ON Semiconductor
19521 E. 32nd Pkwy, Aurora, Colorado 80011 USA
Phone: 303-675-2175 or 800-344-3860 Toll Free USA/Canada
Fax: 303-675-2176 or 800-344-3867 Toll Free USA/Canada
Email: orderlit@onsemi.com

N. American Technical Support: 800-282-9855 Toll Free
USA/Canada
Europe, Middle East and Africa Technical Support:
Phone: 421 33 790 2910
Japan Customer Focus Center
Phone: 81-3-5817-1050

ON Semiconductor Website: www.onsemi.com
Order Literature: <http://www.onsemi.com/orderlit>

For additional information, please contact your local Sales Representative