



Is Now Part of



ON Semiconductor®

To learn more about ON Semiconductor, please visit our website at
www.onsemi.com

Please note: As part of the Fairchild Semiconductor integration, some of the Fairchild orderable part numbers will need to change in order to meet ON Semiconductor's system requirements. Since the ON Semiconductor product management systems do not have the ability to manage part nomenclature that utilizes an underscore (_), the underscore (_) in the Fairchild part numbers will be changed to a dash (-). This document may contain device numbers with an underscore (_). Please check the ON Semiconductor website to verify the updated device numbers. The most current and up-to-date ordering information can be found at www.onsemi.com. Please email any questions regarding the system integration to Fairchild_questions@onsemi.com.

ON Semiconductor and the ON Semiconductor logo are trademarks of Semiconductor Components Industries, LLC dba ON Semiconductor or its subsidiaries in the United States and/or other countries. ON Semiconductor owns the rights to a number of patents, trademarks, copyrights, trade secrets, and other intellectual property. A listing of ON Semiconductor's product/patent coverage may be accessed at www.onsemi.com/site/pdf/Patent-Marking.pdf. ON Semiconductor reserves the right to make changes without further notice to any products herein. ON Semiconductor makes no warranty, representation or guarantee regarding the suitability of its products for any particular purpose, nor does ON Semiconductor assume any liability arising out of the application or use of any product or circuit, and specifically disclaims any and all liability, including without limitation special, consequential or incidental damages. Buyer is responsible for its products and applications using ON Semiconductor products, including compliance with all laws, regulations and safety requirements or standards, regardless of any support or applications information provided by ON Semiconductor. "Typical" parameters which may be provided in ON Semiconductor data sheets and/or specifications can and do vary in different applications and actual performance may vary over time. All operating parameters, including "Typicals" must be validated for each customer application by customer's technical experts. ON Semiconductor does not convey any license under its patent rights nor the rights of others. ON Semiconductor products are not designed, intended, or authorized for use as a critical component in life support systems or any FDA Class 3 medical devices or medical devices with a same or similar classification in a foreign jurisdiction or any devices intended for implantation in the human body. Should Buyer purchase or use ON Semiconductor products for any such unintended or unauthorized application, Buyer shall indemnify and hold ON Semiconductor and its officers, employees, subsidiaries, affiliates, and distributors harmless against all claims, costs, damages, and expenses, and reasonable attorney fees arising out of, directly or indirectly, any claim of personal injury or death associated with such unintended or unauthorized use, even if such claim alleges that ON Semiconductor was negligent regarding the design or manufacture of the part. ON Semiconductor is an Equal Opportunity/Affirmative Action Employer. This literature is subject to all applicable copyright laws and is not for resale in any manner.



FDPC3D5N025X9D

PowerTrench® Power Clip

25V Symmetric Dual N-Channel MOSFET

Features

- Q1: N-Channel
- Max $r_{DS(on)}$ = 3.01 mΩ at $V_{GS} = 10\text{ V}$, $I_D = 18\text{ A}$
 - Max $r_{DS(on)}$ = 3.67 mΩ at $V_{GS} = 4.5\text{ V}$, $I_D = 16\text{ A}$
- Q2: N-Channel
- Max $r_{DS(on)}$ = 3.01 mΩ at $V_{GS} = 10\text{ V}$, $I_D = 18\text{ A}$
 - Max $r_{DS(on)}$ = 3.67 mΩ at $V_{GS} = 4.5\text{ V}$, $I_D = 16\text{ A}$
 - Low Inductance Packaging Shortens Rise/Fall Times, Resulting in Lower Switching Losses
 - MOSFET Integration Enables Optimum Layout for Lower Circuit Inductance and Reduced Switch Node Ringing
 - RoHS Compliant



General Description

This device includes two specialized N-Channel MOSFETs in a dual package. The switch node has been internally connected to enable easy placement and routing of synchronous buck converters. The control MOSFET (Q2) and synchronous (Q1) have been designed to provide optimal power efficiency.

Applications

- Computing
- Communications
- General Purpose Point of Load

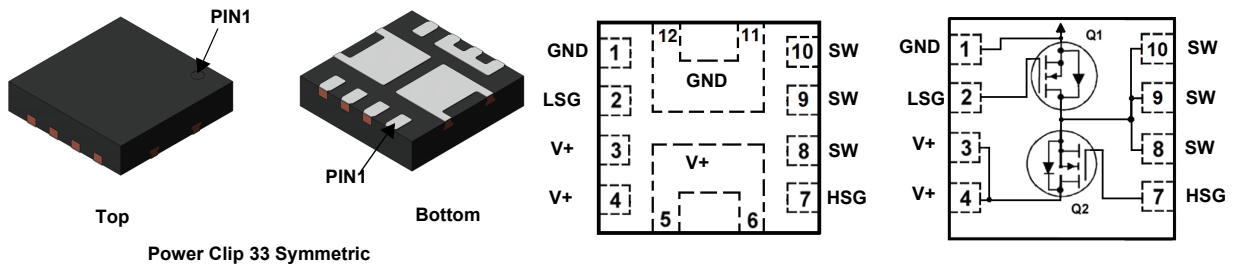

Pin	Name	Description	Pin	Name	Description	Pin	Name	Description
1,11,12	GND(LSS)	Low Side Source	3,4,5,6	V+(HSD)	High Side Drain	8,9,10	SW	Switching Node, Low Side Drain
2	LSG	Low Side Gate	7	HSG	High Side Gate			

MOSFET Maximum Ratings $T_A = 25\text{ °C}$ unless otherwise noted.

Symbol	Parameter	Q1	Q2	Units
V_{DS}	Drain to Source Voltage	25	25	V
V_{GS}	Gate to Source Voltage	±12	±12	V
I_D	Drain Current -Continuous $T_C = 25\text{ °C}$ (Note5)	74	74	A
	-Continuous $T_C = 100\text{ °C}$ (Note5)	47	47	
	-Continuous $T_A = 25\text{ °C}$	18 ^{Note1a}	18 ^{Note1b}	
	-Pulsed $T_A = 25\text{ °C}$ (Note 4)	349	349	
E_{AS}	Single Pulse Avalanche Energy (Note 3)	96	96	mJ
P_D	Power Dissipation for Single Operation $T_C = 25\text{ °C}$	26	26	W
	Power Dissipation for Single Operation $T_A = 25\text{ °C}$	1.8 ^{Note1a}	1.8 ^{Note1b}	
T_J, T_{STG}	Operating and Storage Junction Temperature Range	-55 to +150		°C

Thermal Characteristics

$R_{\theta JC}$	Thermal Resistance, Junction to Case	4.8	4.8	°C/W
$R_{\theta JA}$	Thermal Resistance, Junction to Ambient	70 ^{Note1a}	70 ^{Note1b}	
$R_{\theta JA}$	Thermal Resistance, Junction to Ambient	135 ^{Note1c}	135 ^{Note1d}	

Package Marking and Ordering Information

Device Marking	Device	Package	Reel Size	Tape Width	Quantity
FDPCN025X9D	FDPC3D5N025X9D	Power Clip 33 Symm	13 "	12 mm	3000 units

Electrical Characteristics $T_J = 25\text{ }^\circ\text{C}$ unless otherwise noted.

Symbol	Parameter	Test Conditions	Type	Min.	Typ.	Max.	Units
--------	-----------	-----------------	------	------	------	------	-------

Off Characteristics

BV_{DSS}	Drain to Source Breakdown Voltage	$I_D = 250\text{ }\mu\text{A}, V_{GS} = 0\text{ V}$ $I_D = 250\text{ }\mu\text{A}, V_{GS} = 0\text{ V}$	Q1 Q2	25 25			V
$\frac{\Delta BV_{DSS}}{\Delta T_J}$	Breakdown Voltage Temperature Coefficient	$I_D = 250\text{ }\mu\text{A}$, referenced to $25\text{ }^\circ\text{C}$ $I_D = 250\text{ }\mu\text{A}$, referenced to $25\text{ }^\circ\text{C}$	Q1 Q2		23 23		mV/°C
I_{DSS}	Zero Gate Voltage Drain Current	$V_{DS} = 20\text{ V}, V_{GS} = 0\text{ V}$ $V_{DS} = 20\text{ V}, V_{GS} = 0\text{ V}$	Q1 Q2			1 1	μA μA
I_{GSS}	Gate to Source Leakage Current, Forward	$V_{GS} = 12\text{ V}/-8\text{ V}, V_{DS} = 0\text{ V}$ $V_{GS} = 12\text{ V}/-8\text{ V}, V_{DS} = 0\text{ V}$	Q1 Q2			± 100 ± 100	nA nA

On Characteristics

$V_{GS(th)}$	Gate to Source Threshold Voltage	$V_{GS} = V_{DS}, I_D = 250\text{ }\mu\text{A}$ $V_{GS} = V_{DS}, I_D = 250\text{ }\mu\text{A}$	Q1 Q2	1.0 1.0	1.5 1.5	3.0 3.0	V
$\frac{\Delta V_{GS(th)}}{\Delta T_J}$	Gate to Source Threshold Voltage Temperature Coefficient	$I_D = 250\text{ }\mu\text{A}$, referenced to $25\text{ }^\circ\text{C}$ $I_D = 250\text{ }\mu\text{A}$, referenced to $25\text{ }^\circ\text{C}$	Q1 Q2		-4 -4		mV/°C
$r_{DS(on)}$	Drain to Source On Resistance	$V_{GS} = 10\text{ V}, I_D = 18\text{ A}$ $V_{GS} = 4.5\text{ V}, I_D = 16\text{ A}$ $V_{GS} = 10\text{ V}, I_D = 18\text{ A}, T_J = 125\text{ }^\circ\text{C}$	Q1		2.0 2.4 2.87	3.01 3.67 4.32	m Ω
		$V_{GS} = 10\text{ V}, I_D = 18\text{ A}$ $V_{GS} = 4.5\text{ V}, I_D = 16\text{ A}$ $V_{GS} = 10\text{ V}, I_D = 18\text{ A}, T_J = 125\text{ }^\circ\text{C}$	Q2		2.5 2.9 3.6	3.01 3.67 4.33	
g_{FS}	Forward Transconductance	$V_{DS} = 5\text{ V}, I_D = 18\text{ A}$ $V_{DS} = 5\text{ V}, I_D = 18\text{ A}$	Q1 Q2		133 124		S

Dynamic Characteristics

C_{iss}	Input Capacitance	Q1: Q2:	Q1 Q2		2385 2385	3340 3340	pF
C_{oss}	Output Capacitance	$V_{DS} = 13\text{ V}, V_{GS} = 0\text{ V}, f = 1\text{ MHz}$	Q1 Q2		612 612	860 860	
C_{riss}	Reverse Transfer Capacitance	Q2: $V_{DS} = 13\text{ V}, V_{GS} = 0\text{ V}, f = 1\text{ MHz}$	Q1 Q2		78 78	130 130	pF
R_g	Gate Resistance		Q1 Q2	0.1 0.1	0.6 0.6	1.8 1.8	

Switching Characteristics

$t_{d(on)}$	Turn-On Delay Time		Q1 Q2		10 10	20 20	ns
t_r	Rise Time	Q1: $V_{DD} = 13\text{ V}, I_D = 18\text{ A}, R_{GEN} = 6\text{ }\Omega$	Q1 Q2		3 3	10 10	
$t_{d(off)}$	Turn-Off Delay Time	Q2: $V_{DD} = 13\text{ V}, I_D = 18\text{ A}, R_{GEN} = 6\text{ }\Omega$	Q1 Q2		29 29	46 46	ns
t_f	Fall Time		Q1 Q2		3 3	10 10	
Q_g	Total Gate Charge	$V_{GS} = 0\text{ V to }10\text{ V}$	Q1 Q2		36 36	51 51	nC
Q_g	Total Gate Charge	$V_{GS} = 0\text{ V to }4.5\text{ V}$	Q1 Q2		17 17	24 24	
Q_{gs}	Gate to Source Gate Charge		Q1 Q2		5.3 5.3		nC
Q_{gd}	Gate to Drain "Miller" Charge		Q1 Q2		3.9 3.9		

Electrical Characteristics $T_J = 25\text{ }^\circ\text{C}$ unless otherwise noted.

Symbol	Parameter	Test Conditions	Type	Min.	Typ.	Max.	Units
V_{SD}	Source to Drain Diode Forward Voltage	$V_{GS} = 0\text{ V}, I_S = 18\text{ A}$ (Note 2)	Q1		0.8	1.2	V
		$V_{GS} = 0\text{ V}, I_S = 18\text{ A}$ (Note 2)	Q2		0.8	1.2	
I_S	Diode continuous forward current	$T_C = 25\text{ }^\circ\text{C}$	Q1		74		A
			Q2		74		
$I_{S,Pulse}$	Diode pulse current		Q1		349		A
			Q2		349		
t_{rr}	Reverse Recovery Time	Q1 $I_F = 18\text{ A}, di/dt = 100\text{ A}/\mu\text{s}$	Q1		35	56	ns
		Q2	Q2		35	56	
Q_{rr}	Reverse Recovery Charge	$I_F = 18\text{ A}, di/dt = 100\text{ A}/\mu\text{s}$	Q1		19	35	nC
			Q2		19	35	

Notes:

1. $R_{\theta JA}$ is determined with the device mounted on a 1 in² pad 2 oz copper pad on a 1.5 x 1.5 in. board of FR-4 material. $R_{\theta CA}$ is determined by the user's board design.

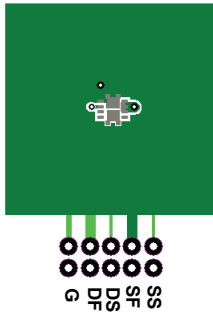

a. 70 °C/W when mounted on a 1 in² pad of 2 oz copper

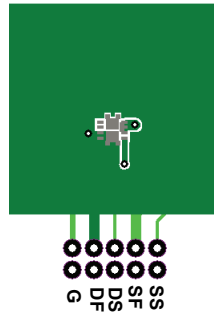

b. 70 °C/W when mounted on a 1 in² pad of 2 oz copper

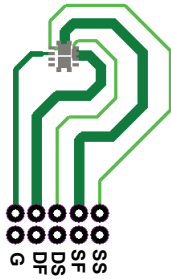

c. 135 °C/W when mounted on a minimum pad of 2 oz copper

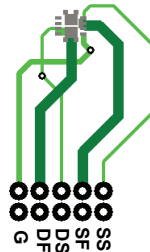

d. 135 °C/W when mounted on a minimum pad of 2 oz copper

2. Pulse Test: Pulse Width < 300 μs , Duty cycle < 2.0%.

3. Q1 : E_{AS} of 96 mJ is based on starting $T_J = 25\text{ }^\circ\text{C}$; N-ch: $L = 3\text{ mH}, I_{AS} = 8\text{ A}, V_{DD} = 25\text{ V}, V_{GS} = 10\text{ V}$. 100% test at $L = 0.1\text{ mH}, I_{AS} = 26\text{ A}$.

Q2: E_{AS} of 96 mJ is based on starting $T_J = 25\text{ }^\circ\text{C}$; N-ch: $L = 3\text{ mH}, I_{AS} = 8\text{ A}, V_{DD} = 25\text{ V}, V_{GS} = 10\text{ V}$. 100% test at $L = 0.1\text{ mH}, I_{AS} = 26\text{ A}$.

4. Pulse I_d refers to Figure.11 & Figure. 26 Forward Bias Safe Operation Area.

5. Computed continuous current limited to Max Junction Temperature only, actual continuous current will be limited by thermal & electro-mechanical application board design.

Typical Characteristics (Q1 N-Channel) $T_J = 25^\circ\text{C}$ unless otherwise noted.

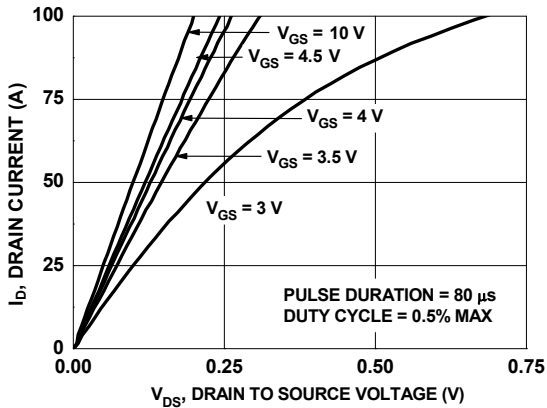

Figure 1. On Region Characteristics

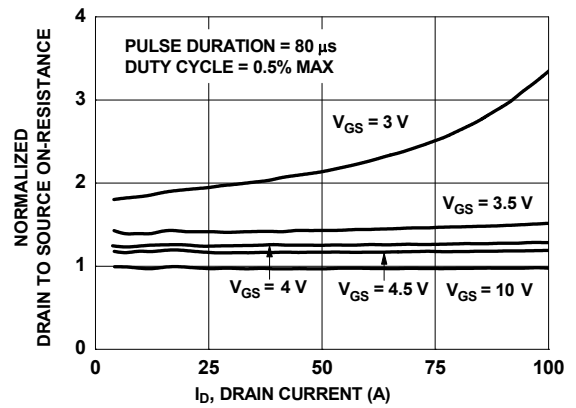

Figure 2. Normalized On-Resistance vs. Drain Current and Gate Voltage

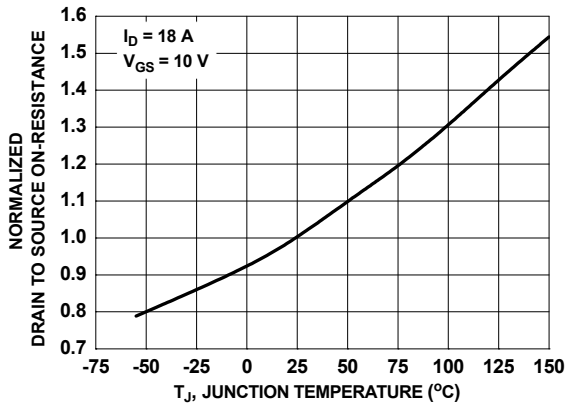

Figure 3. Normalized On Resistance vs. Junction Temperature

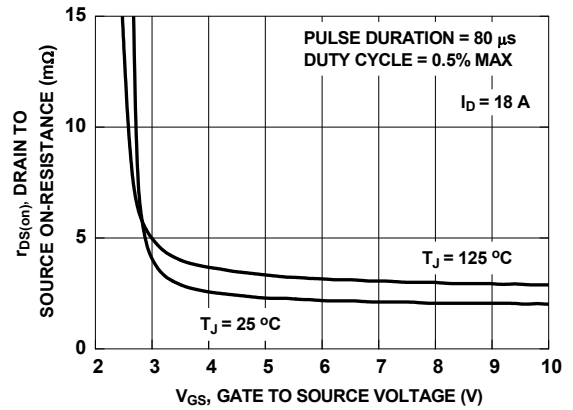

Figure 4. On-Resistance vs. Gate to Source Voltage

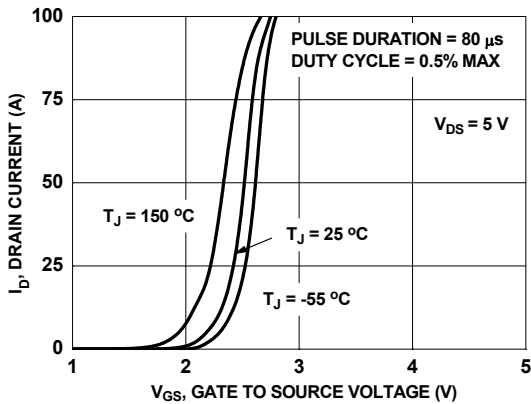

Figure 5. Transfer Characteristics

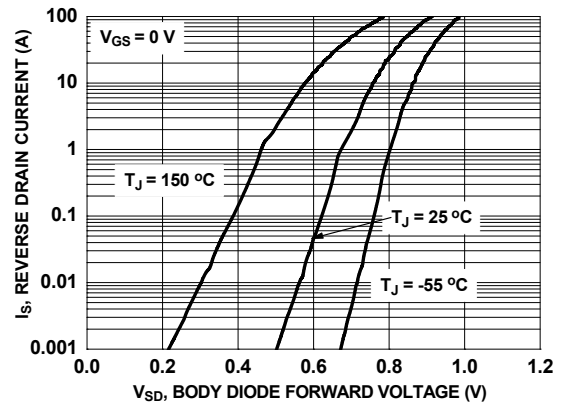

Figure 6. Source to Drain Diode Forward Voltage vs. Source Current

Typical Characteristics (Q1 N-Channel) $T_J = 25^\circ\text{C}$ unless otherwise noted.

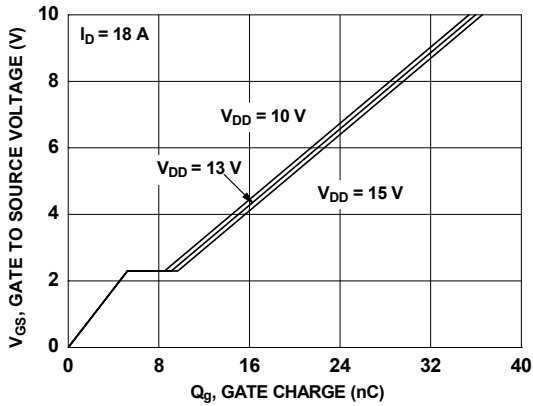

Figure 7. Gate Charge Characteristics

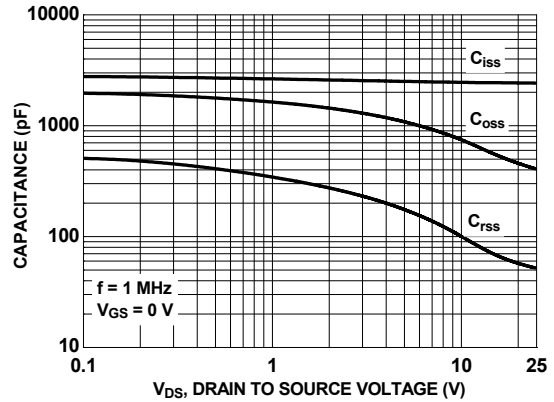

Figure 8. Capacitance vs. Drain to Source Voltage

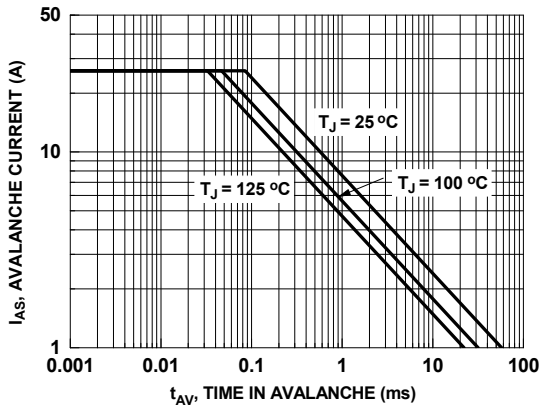

Figure 9. Unclamped Inductive Switching Capability

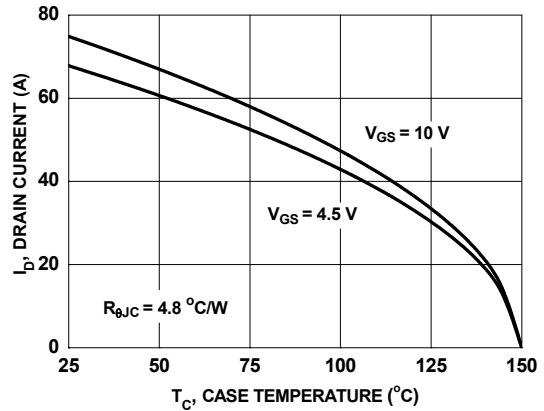

Figure 10. Maximum Continuous Drain Current vs. Case Temperature

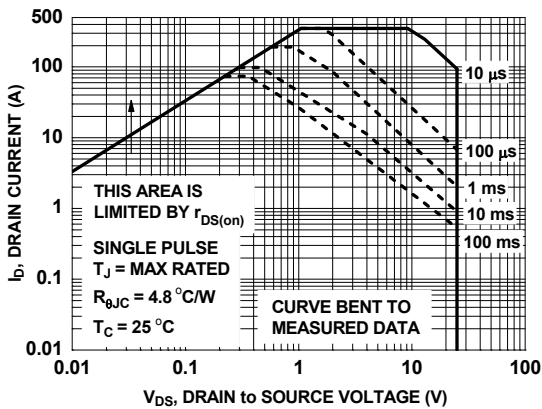

Figure 11. Forward Bias Safe Operating Area

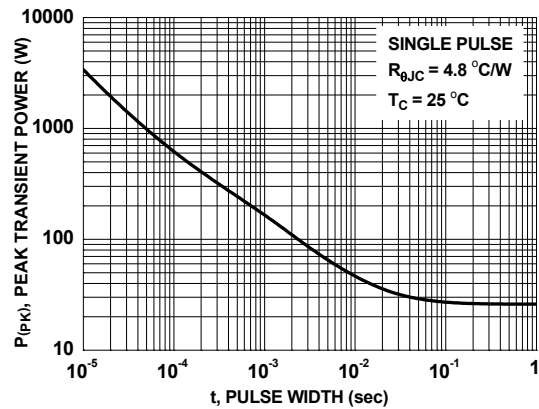

Figure 12. Single Pulse Maximum Power Dissipation

Typical Characteristics (Q1 N-Channel) $T_J = 25^\circ\text{C}$ unless otherwise noted.

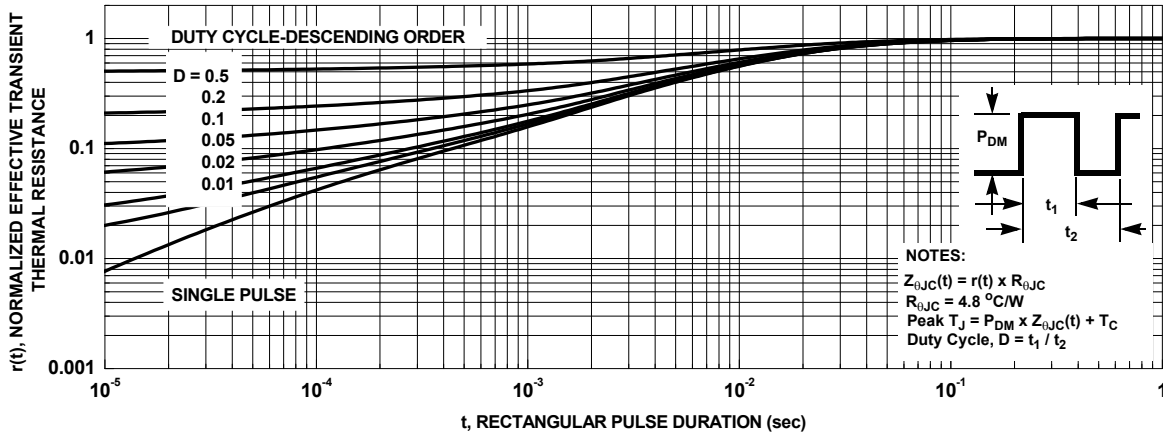

Figure 13. Junction-to-Case Transient Thermal Response Curve

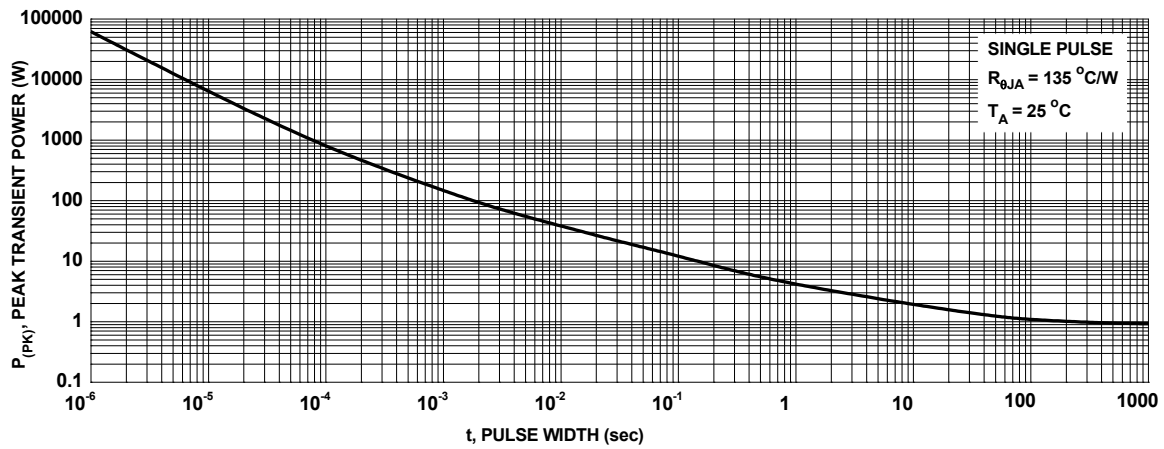

Figure 14. Single Pulse Maximum Power Dissipation

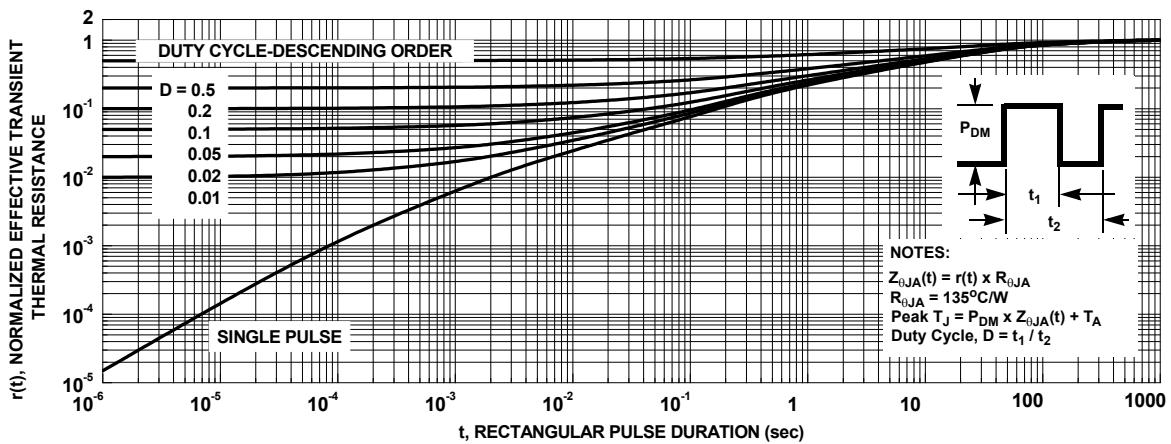

Figure 15. Junction-to-Ambient Transient Thermal Response Curve

Typical Characteristics (Q2 N-Channel) $T_J = 25\text{ }^\circ\text{C}$ unless otherwise noted.

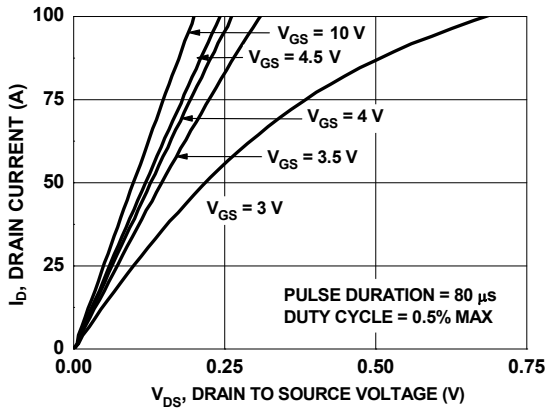

Figure 16. On-Region Characteristics

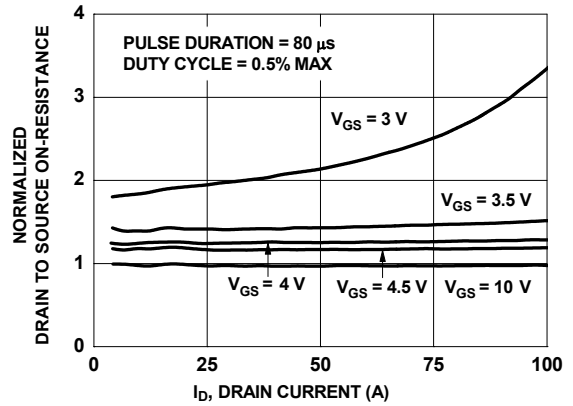

Figure 17. Normalized on-Resistance vs. Drain Current and Gate Voltage

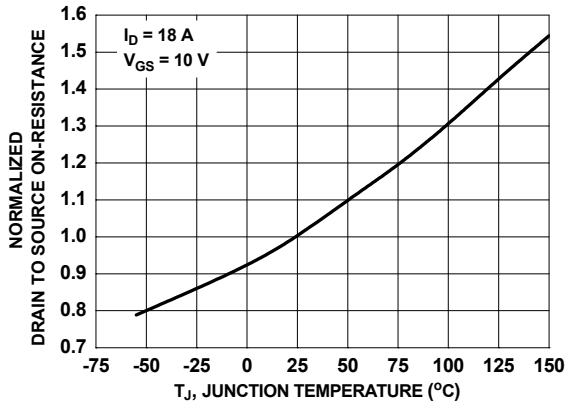

Figure 18. Normalized On-Resistance vs. Junction Temperature

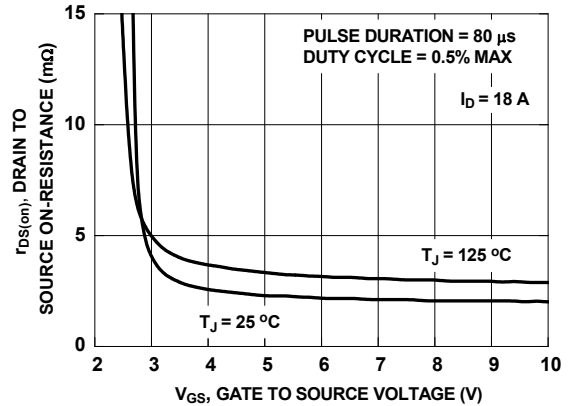

Figure 19. On-Resistance vs. Gate to Source Voltage

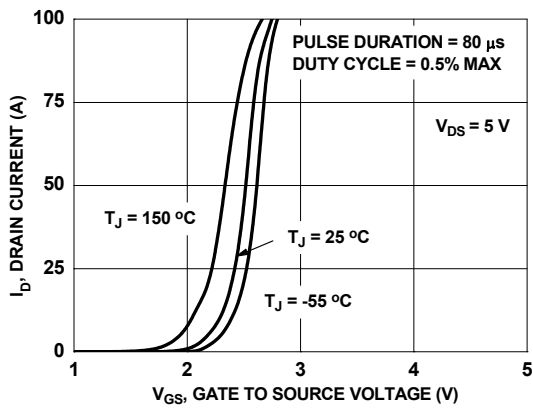

Figure 20. Transfer Characteristics

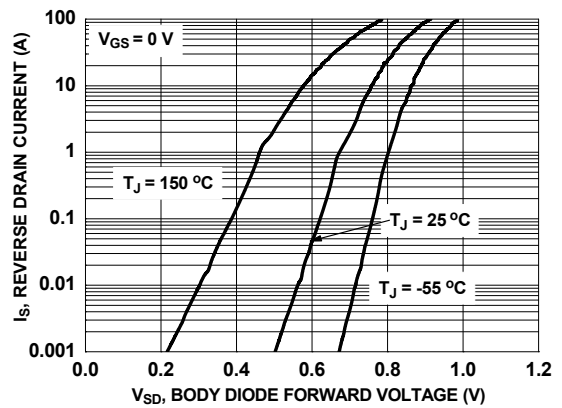

Figure 21. Source to Drain Diode Forward Voltage vs. Source Current

Typical Characteristics (Q2 N-Channel) $T_J = 25^\circ\text{C}$ unless otherwise noted.

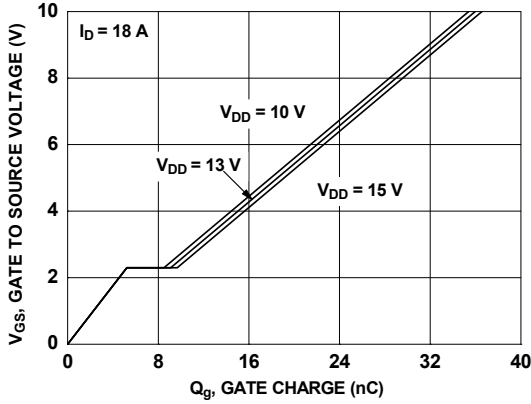

Figure 22. Gate Charge Characteristics

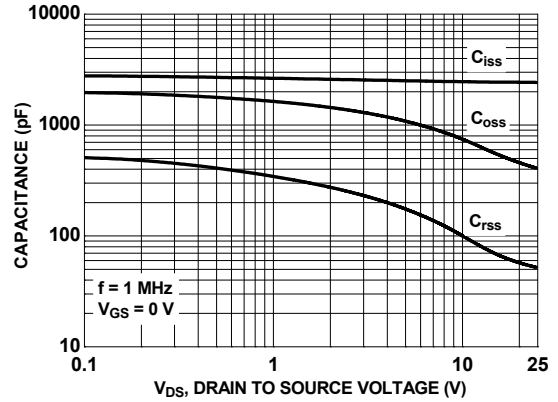

Figure 23. Capacitance vs. Drain to Source Voltage

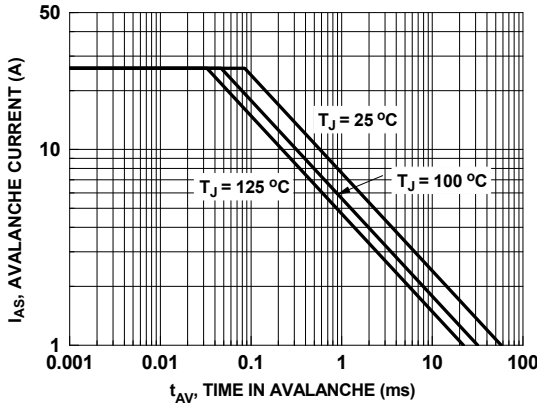

Figure 24. Unclamped Inductive Switching Capability

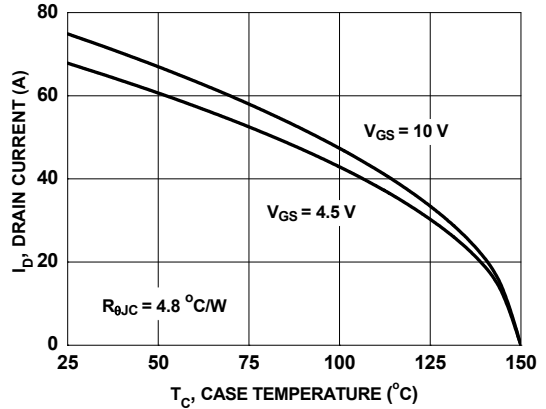

Figure 25. Maximum Continuous Drain Current vs. Case Temperature

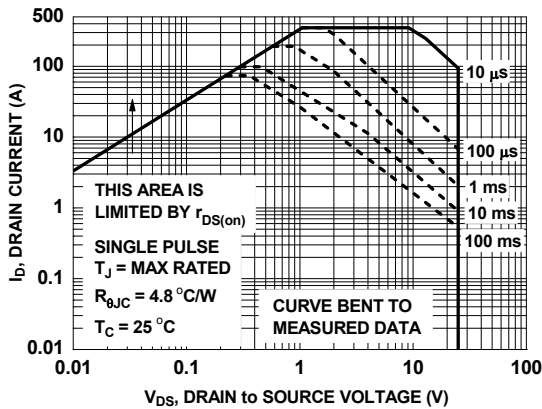

Figure 26. Forward Bias Safe Operating Area

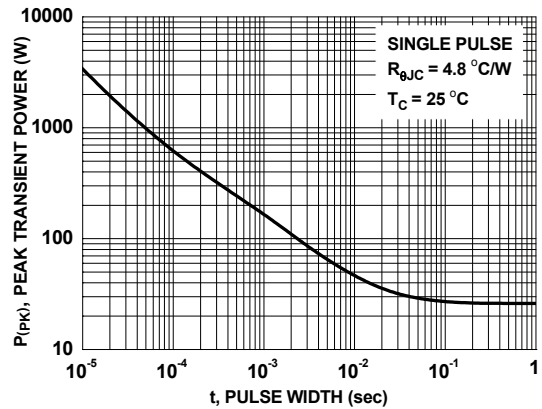

Figure 27. Single Pulse Maximum Power Dissipation

Typical Characteristics (Q2 N-Channel) $T_J = 25\text{ }^\circ\text{C}$ unless otherwise noted.

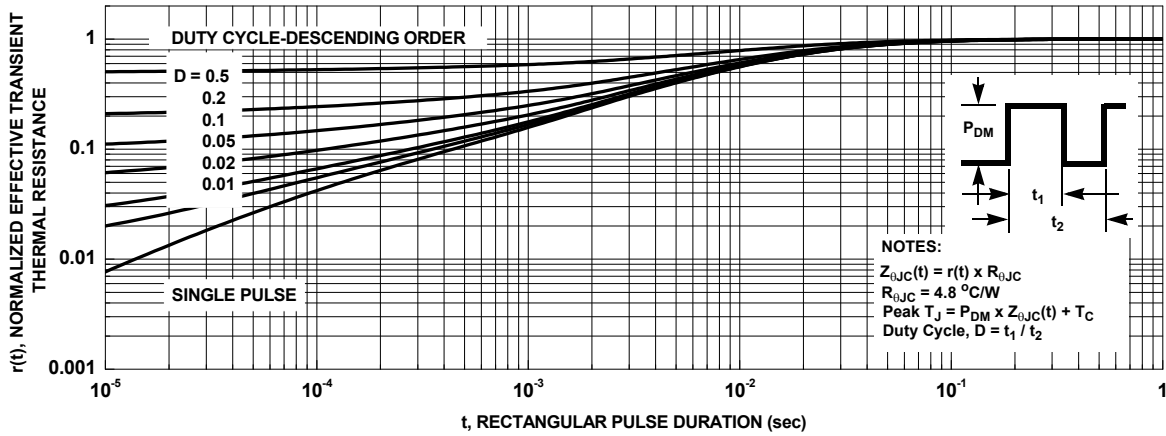

Figure 28. Junction-to-Case Transient Thermal Response Curve

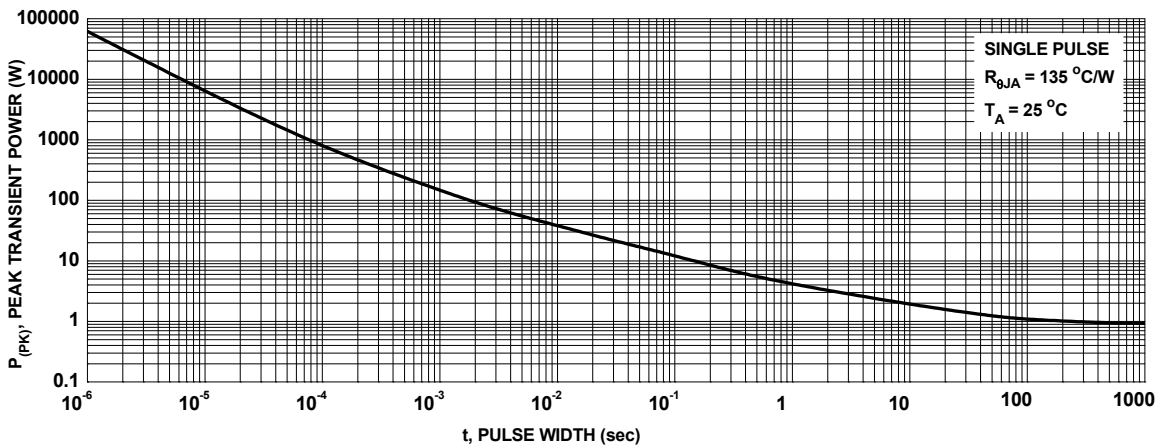

Figure 29. Single Pulse Maximum Power Dissipation

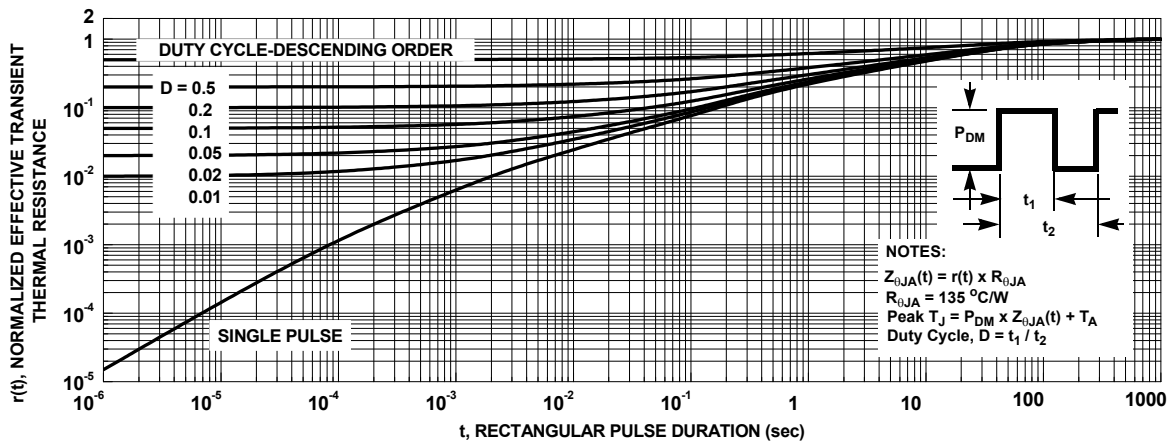
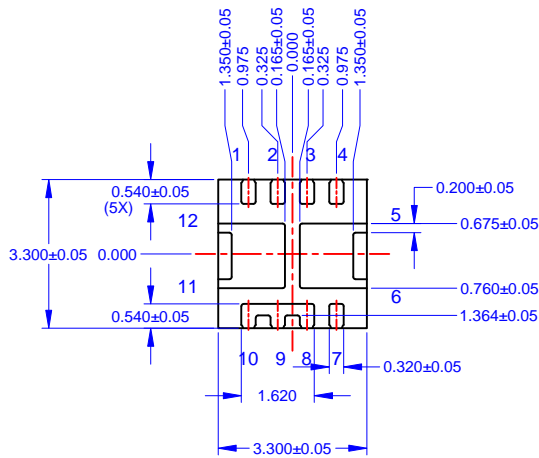
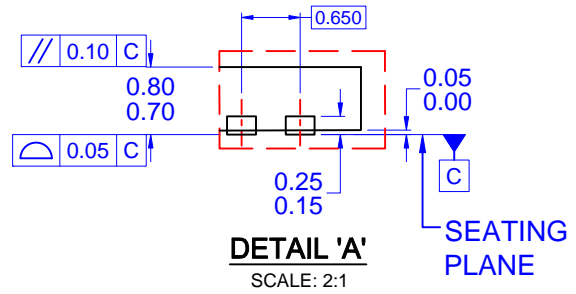
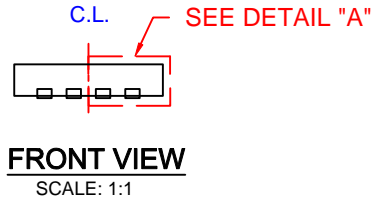
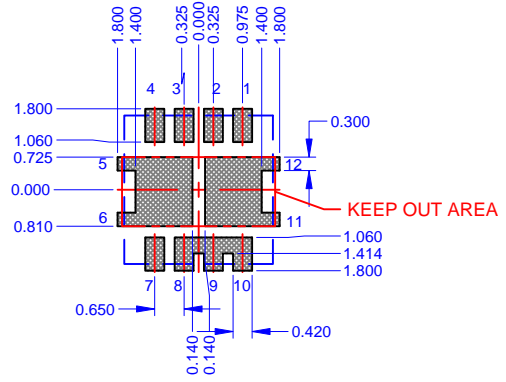
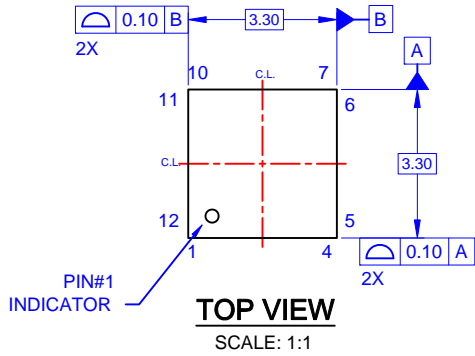

Figure 30. Junction-to-Ambient Transient Thermal Response Curve



NOTES: UNLESS OTHERWISE SPECIFIED

- A) DRAWING DOES NOT FULLY CONFORM TO JEDEC REGISTRATION MO-220, VARIATION WEEC-1
- B) ALL DIMENSIONS ARE IN MILLIMETERS.
- C) DIMENSIONS DO NOT INCLUDE BURRS OR MOLD FLASH. MOLD FLASH OR BURRS DOES NOT EXCEED 0.10MM.
- D) DRAWING FILE NAME: MKT-PQFN12A_REV1

ON Semiconductor



ON Semiconductor and  are trademarks of Semiconductor Components Industries, LLC dba ON Semiconductor or its subsidiaries in the United States and/or other countries. ON Semiconductor owns the rights to a number of patents, trademarks, copyrights, trade secrets, and other intellectual property. A listing of ON Semiconductor's product/patent coverage may be accessed at www.onsemi.com/site/pdf/Patent-Marking.pdf. ON Semiconductor reserves the right to make changes without further notice to any products herein. ON Semiconductor makes no warranty, representation or guarantee regarding the suitability of its products for any particular purpose, nor does ON Semiconductor assume any liability arising out of the application or use of any product or circuit, and specifically disclaims any and all liability, including without limitation special, consequential or incidental damages. Buyer is responsible for its products and applications using ON Semiconductor products, including compliance with all laws, regulations and safety requirements or standards, regardless of any support or applications information provided by ON Semiconductor. "Typical" parameters which may be provided in ON Semiconductor data sheets and/or specifications can and do vary in different applications and actual performance may vary over time. All operating parameters, including "Typicals" must be validated for each customer application by customer's technical experts. ON Semiconductor does not convey any license under its patent rights nor the rights of others. ON Semiconductor products are not designed, intended, or authorized for use as a critical component in life support systems or any FDA Class 3 medical devices or medical devices with a same or similar classification in a foreign jurisdiction or any devices intended for implantation in the human body. Should Buyer purchase or use ON Semiconductor products for any such unintended or unauthorized application, Buyer shall indemnify and hold ON Semiconductor and its officers, employees, subsidiaries, affiliates, and distributors harmless against all claims, costs, damages, and expenses, and reasonable attorney fees arising out of, directly or indirectly, any claim of personal injury or death associated with such unintended or unauthorized use, even if such claim alleges that ON Semiconductor was negligent regarding the design or manufacture of the part. ON Semiconductor is an Equal Opportunity/Affirmative Action Employer. This literature is subject to all applicable copyright laws and is not for resale in any manner.

PUBLICATION ORDERING INFORMATION

LITERATURE FULFILLMENT:

Literature Distribution Center for ON Semiconductor
19521 E. 32nd Pkwy, Aurora, Colorado 80011 USA
Phone: 303-675-2175 or 800-344-3860 Toll Free USA/Canada
Fax: 303-675-2176 or 800-344-3867 Toll Free USA/Canada
Email: orderlit@onsemi.com

N. American Technical Support: 800-282-9855 Toll Free
USA/Canada
Europe, Middle East and Africa Technical Support:
Phone: 421 33 790 2910
Japan Customer Focus Center
Phone: 81-3-5817-1050

ON Semiconductor Website: www.onsemi.com
Order Literature: <http://www.onsemi.com/orderlit>
For additional information, please contact your local
Sales Representative