

NSVS50030SB3, NSVS50031SB3

Bipolar Transistor (-)50 V, (-)3 A, Low $V_{CE(sat)}$, (PNP)NPN Single

This device is bipolar junction transistor featuring high current, low saturation voltage, and high speed switching.

Suitable for applications, relay driver, DC-DC converter of automotive applications. AEC-Q101qualified and PPAP capable.

Features

- Large Current Capacitance
- Low Collector to Emitter Saturation Voltage
- High-Speed Switching
- High Allowable Power Dissipation
- AEC-Q101Qualified and PPAP Capable
- Pb-Free, Halogen Free and RoHS Compliance
- Ultra Small Package Facilitates Miniaturization in End Products (Mounting Height: 0.9 mm)

Typical Applications

- DC / DC Converter
- Relay Drivers, Lamp Drivers, Motor Drivers
- Flash

Specifications

ABSOLUTE MAXIMUM RATINGS at $T_A = 25^\circ\text{C}$

Parameter	Symbol	Value	Unit
Collector to Base Voltage	V_{CBO}	(-50) 100	V
Collector to Emitter Voltage	V_{CES}	(-50) 100	V
Collector to Emitter Voltage	V_{CEO}	(-50)	V
Emitter to Base Voltage	V_{EBO}	(-6)	V
Collector Current	I_C	(-)3	A
Collector Current (Pulse)	I_{CP}	(-)6	A
Base Current	I_B	(-)600	mA
Collector Dissipation (Note 1)	P_C	1.1	W
Junction Temperature	T_J	175	$^\circ\text{C}$
Storage Temperature	T_{stg}	-55 to +175	$^\circ\text{C}$

Stresses exceeding those listed in the Maximum Ratings table may damage the device. If any of these limits are exceeded, device functionality should not be assumed, damage may occur and reliability may be affected.

1. Surface mounted on ceramic substrate. (600 mm² x 0.8 mm)



ON Semiconductor®

www.onsemi.com

ELECTRICAL CONNECTION

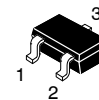
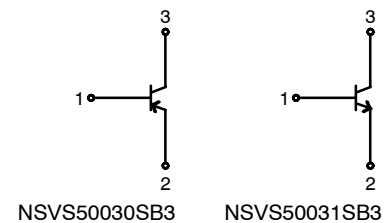

CPH3
CASE 318BA

MARKING DIAGRAMS

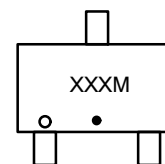

XXX = HAE: NSVS50030SB3
= HCE: NSVS50031SB3
M = Single Digit Date Code

ORDERING INFORMATION

See detailed ordering and shipping information on page 2 of this data sheet.

NSVS50030SB3, NSVS50031SB3

ORDERING INFORMATION

Device	Marking	Package	Shipping (Qty / Packing) †
NSVS50030SB3T1G	HAE	CPH3 (Pb-Free / Halogen Free)	3,000/ Tape & Reel
NSVS50031SB3T1G	HCE		

†For information on tape and reel specifications, including part orientation and tape sizes, please refer to our Tape and Reel Packaging Specification Brochure, BRD8011/D.

ELECTRICAL CHARACTERISTICS (T_C = 25°C unless otherwise noted)

Parameter	Symbol	Conditions	Value			Unit
			Min	Typ	Max	
Collector Cutoff Current	I _{CBO}	V _{CB} = (-)40 V, I _E = 0 A			(-)1	μA
Emitter Cutoff Current	I _{EBO}	V _{EB} = (-)4 V, I _C = 0 A			(-)1	μA
DC Current Gain	h _{FE}	V _{CE} = (-)2 V, I _C = (-)100 mA	200		560	
Gain-Bandwidth Product	f _T	V _{CE} = (-)10 V, I _C = (-)500 mA		(360) 380		MHz
Output Capacitance	C _{ob}	V _{CB} = (-)10 V, f = 1 MHz		(24) 13		pF
Collector to Emitter Saturation Voltage	V _{CE(sat)}	I _C = (-)1 A, I _B = (-)50 mA		(-100) 80	(-200) 120	mV
		I _C = (-)2 A, I _B = (-)100 mA		(-185) 140	(-500) 210	mV
Base to Emitter Saturation Voltage	V _{BE(sat)}	I _C = (-)2 A, I _B = (-)100 mA		(-)0.88	(-)1.2	V
Collector to Base Breakdown Voltage	V _{(BR)CBO}	I _C = (-)10 μA, I _E = 0 A	(-50) 100			V
Collector to Emitter Breakdown Voltage	V _{(BR)CES}	I _C = (-)100 μA, R _{BE} = 0 Ω	(-50) 100			V
Collector to Emitter Breakdown Voltage	V _{(BR)CEO}	I _C = (-)1 mA, R _{BE} = ∞	(-)50			V
Emitter to Base Breakdown Voltage	V _{(BR)EBO}	I _E = (-)10 μA, I _C = 0 A	(-)6			V
Turn-On Time	t _{on}	See Fig.1		(30) 35		ns
Storage Time	t _{stg}			(230) 300		ns
Fall Time	t _f			(15) 22		ns

Product parametric performance is indicated in the Electrical Characteristics for the listed test conditions, unless otherwise noted. Product performance may not be indicated by the Electrical Characteristics if operated under different conditions.

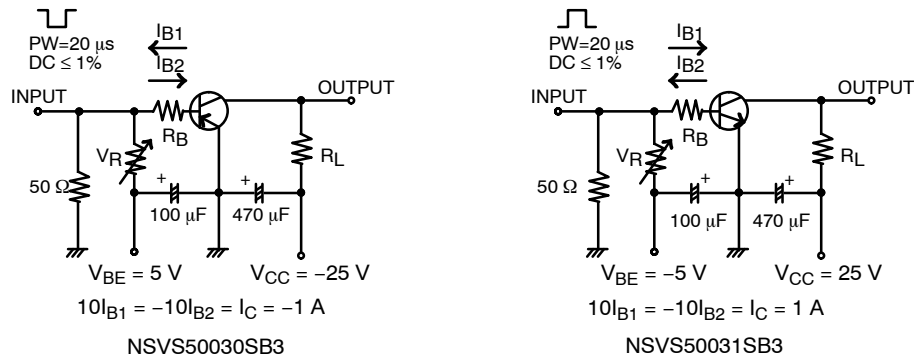

Figure 1. Switching Time Test Circuit

NSVS50030SB3, NSVS50031SB3

TYPICAL PERFORMANCE CHARACTERISTICS

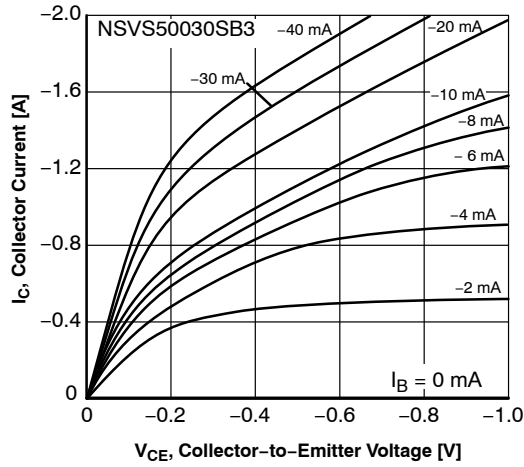

Figure 2. $I_C - V_{CE}$

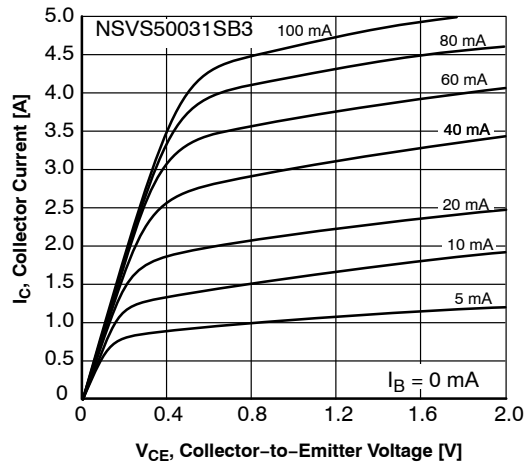

Figure 3. $I_C - V_{CE}$

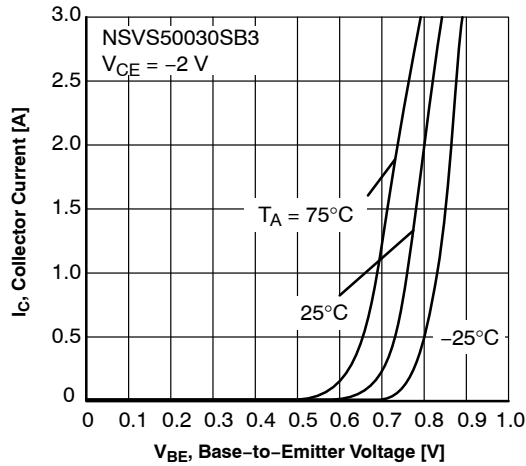

Figure 4. $I_C - V_{BE}$

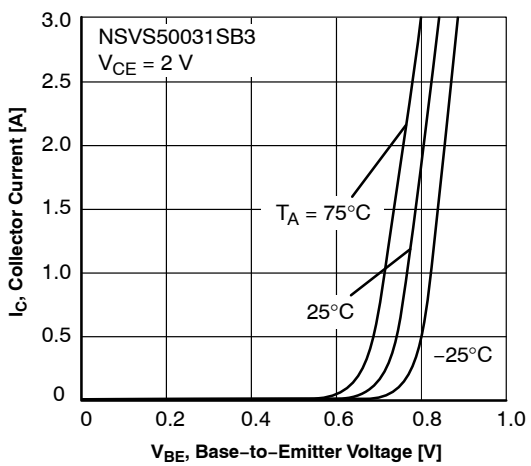

Figure 5. $I_C - V_{BE}$

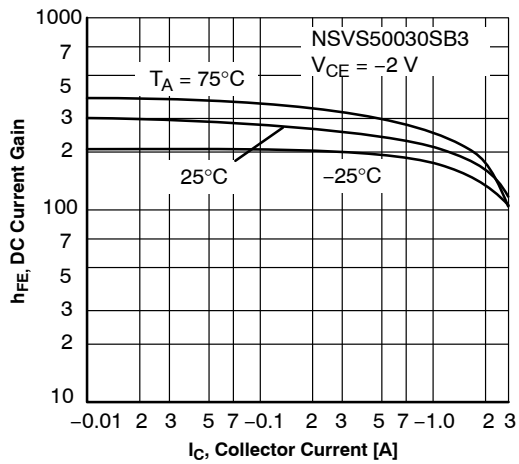

Figure 6. $h_{FE} - I_C$

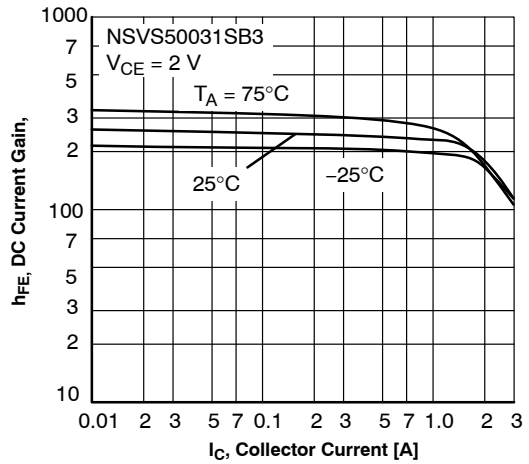

Figure 7. $h_{FE} - I_C$

NSVS50030SB3, NSVS50031SB3

TYPICAL PERFORMANCE CHARACTERISTICS (Continued)

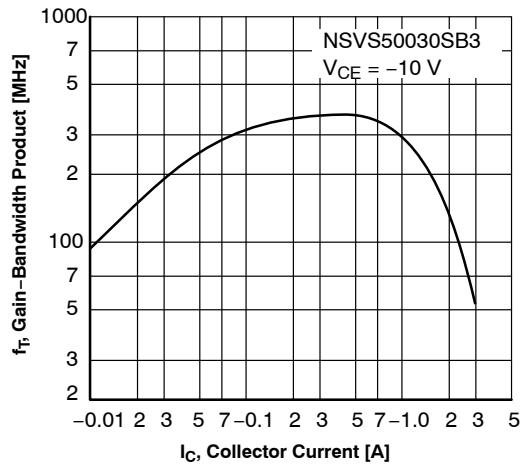

Figure 8. $f_T - I_C$

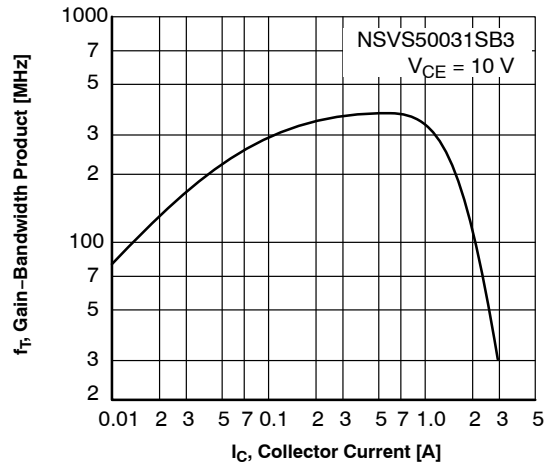

Figure 9. $f_T - I_C$

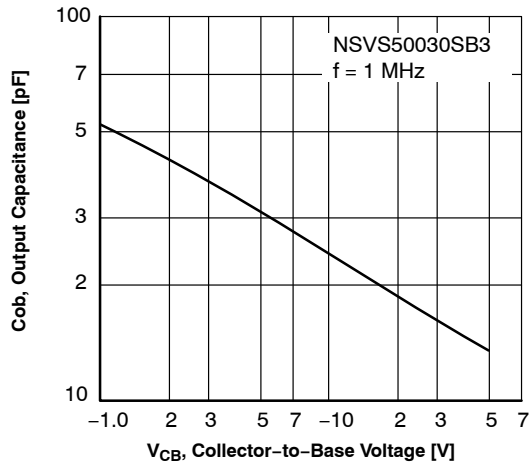

Figure 10. $C_{ob} - V_{CB}$

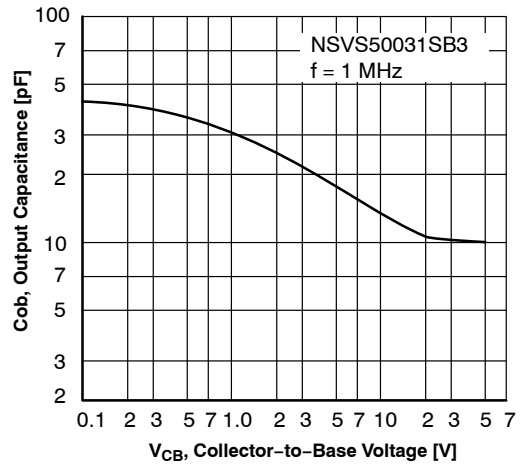

Figure 11. $C_{ob} - V_{CB}$

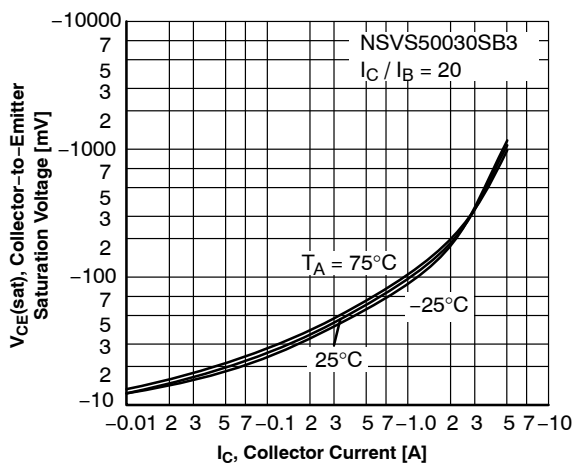

Figure 12. $V_{CE(sat)} - I_C$

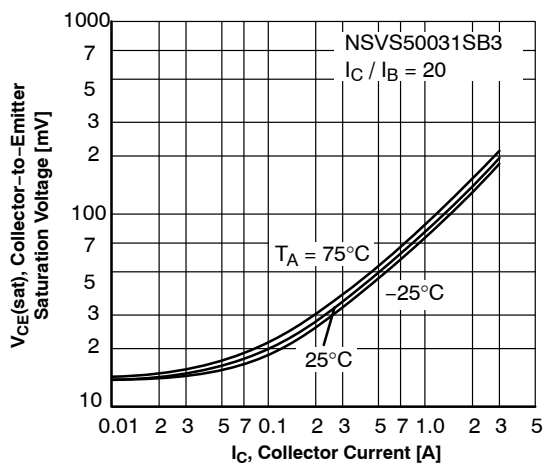

Figure 13. $V_{CE(sat)} - I_C$

NSVS50030SB3, NSVS50031SB3

TYPICAL PERFORMANCE CHARACTERISTICS (Continued)

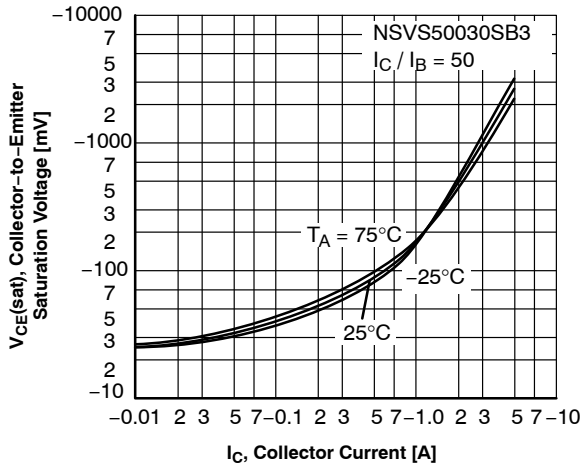

Figure 14. $V_{CE(sat)} - I_C$

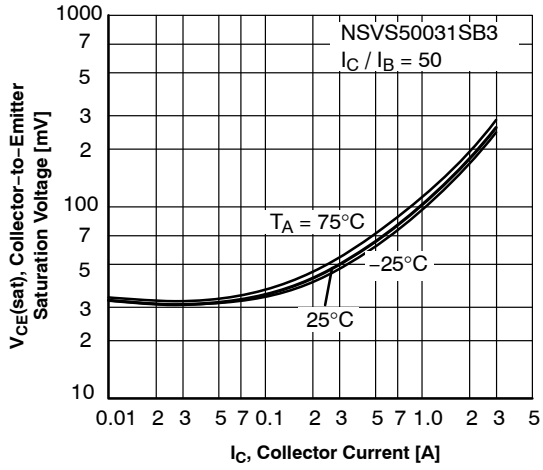

Figure 15. $V_{CE(sat)} - I_C$

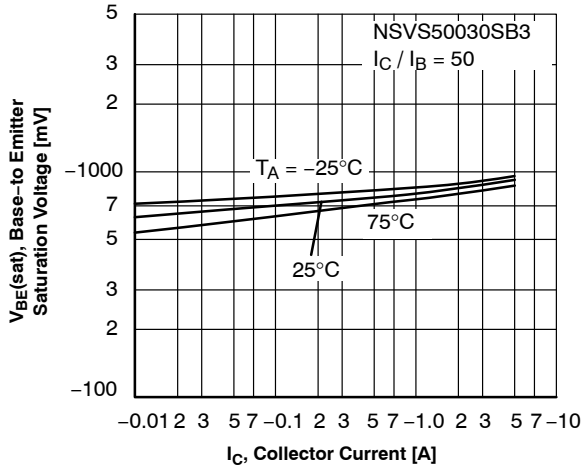

Figure 16. $V_{BE(sat)} - I_C$

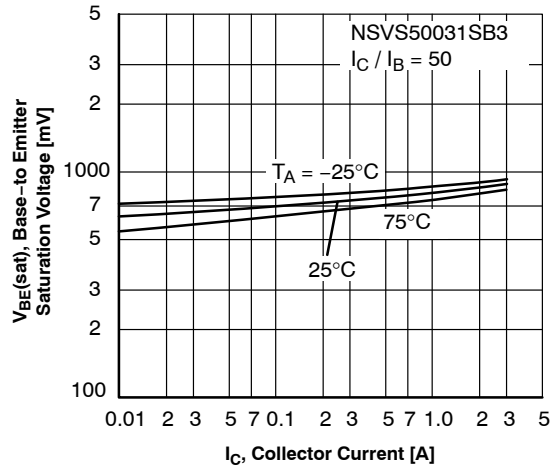

Figure 17. $V_{BE(sat)} - I_C$

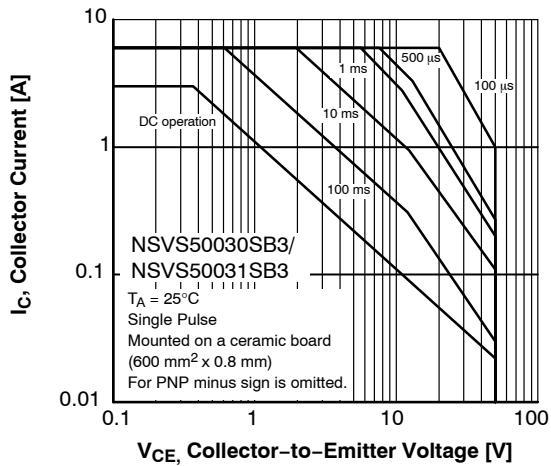

Figure 18. ASO

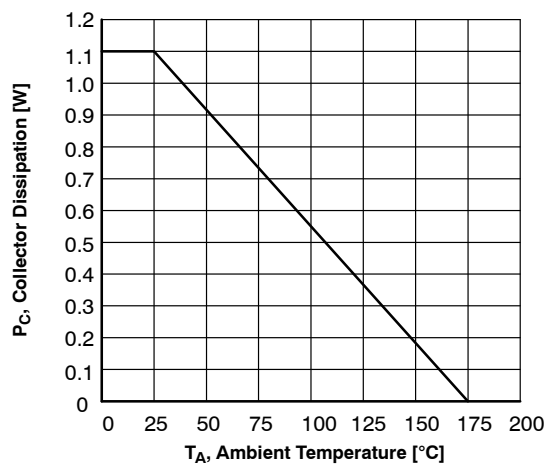
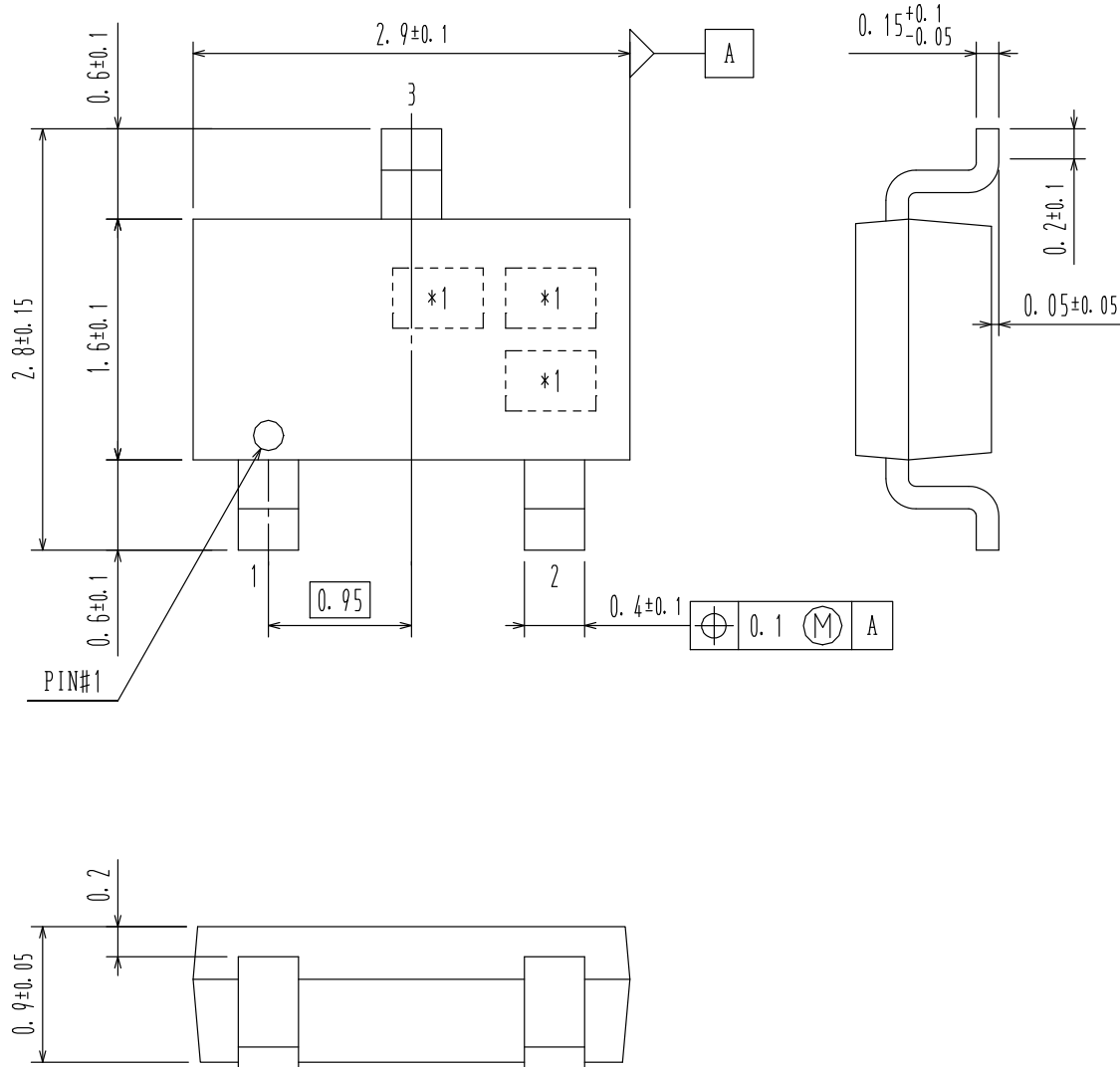

Figure 19. $P_C - T_A$

CPH3
CASE 318BA
ISSUE O

DATE 30 NOV 2011



DOCUMENT NUMBER:	98AON65437E	Electronic versions are uncontrolled except when accessed directly from the Document Repository. Printed versions are uncontrolled except when stamped "CONTROLLED COPY" in red.
DESCRIPTION:	CPH3	PAGE 1 OF 1

ON Semiconductor and **ON** are trademarks of Semiconductor Components Industries, LLC dba ON Semiconductor or its subsidiaries in the United States and/or other countries. ON Semiconductor reserves the right to make changes without further notice to any products herein. ON Semiconductor makes no warranty, representation or guarantee regarding the suitability of its products for any particular purpose, nor does ON Semiconductor assume any liability arising out of the application or use of any product or circuit, and specifically disclaims any and all liability, including without limitation special, consequential or incidental damages. ON Semiconductor does not convey any license under its patent rights nor the rights of others.

ON Semiconductor and  are trademarks of Semiconductor Components Industries, LLC dba ON Semiconductor or its subsidiaries in the United States and/or other countries. ON Semiconductor owns the rights to a number of patents, trademarks, copyrights, trade secrets, and other intellectual property. A listing of ON Semiconductor's product/patent coverage may be accessed at www.onsemi.com/site/pdf/Patent-Marking.pdf. ON Semiconductor reserves the right to make changes without further notice to any products herein. ON Semiconductor makes no warranty, representation or guarantee regarding the suitability of its products for any particular purpose, nor does ON Semiconductor assume any liability arising out of the application or use of any product or circuit, and specifically disclaims any and all liability, including without limitation special, consequential or incidental damages. Buyer is responsible for its products and applications using ON Semiconductor products, including compliance with all laws, regulations and safety requirements or standards, regardless of any support or applications information provided by ON Semiconductor. "Typical" parameters which may be provided in ON Semiconductor data sheets and/or specifications can and do vary in different applications and actual performance may vary over time. All operating parameters, including "Typicals" must be validated for each customer application by customer's technical experts. ON Semiconductor does not convey any license under its patent rights nor the rights of others. ON Semiconductor products are not designed, intended, or authorized for use as a critical component in life support systems or any FDA Class 3 medical devices or medical devices with a same or similar classification in a foreign jurisdiction or any devices intended for implantation in the human body. Should Buyer purchase or use ON Semiconductor products for any such unintended or unauthorized application, Buyer shall indemnify and hold ON Semiconductor and its officers, employees, subsidiaries, affiliates, and distributors harmless against all claims, costs, damages, and expenses, and reasonable attorney fees arising out of, directly or indirectly, any claim of personal injury or death associated with such unintended or unauthorized use, even if such claim alleges that ON Semiconductor was negligent regarding the design or manufacture of the part. ON Semiconductor is an Equal Opportunity/Affirmative Action Employer. This literature is subject to all applicable copyright laws and is not for resale in any manner.

PUBLICATION ORDERING INFORMATION

LITERATURE FULFILLMENT:

Email Requests to: orderlit@onsemi.com

ON Semiconductor Website: www.onsemi.com

TECHNICAL SUPPORT

North American Technical Support:
Voice Mail: 1 800-282-9855 Toll Free USA/Canada
Phone: 011 421 33 790 2910

Europe, Middle East and Africa Technical Support:

Phone: 00421 33 790 2910

For additional information, please contact your local Sales Representative