

# Single, Dual, Quad Low-Voltage, Rail-to-Rail Operational Amplifiers

## LMV321, NCV321, LMV358, LMV324

The LMV321, LMV321I, NCV321, LMV358/LMV358I and LMV324 are CMOS single, dual, and quad low voltage operational amplifiers with rail-to-rail output swing. These amplifiers are a cost-effective solution for applications where low power consumption and space saving packages are critical. Specification tables are provided for operation from power supply voltages at 2.7 V and 5 V. Rail-to-Rail operation provides improved signal-to-noise performance. Ultra low quiescent current makes this series of amplifiers ideal for portable, battery operated equipment. The common mode input range includes ground making the device useful for low-side current-shunt measurements. The ultra small packages allow for placement on the PCB in close proximity to the signal source thereby reducing noise pickup.

### Features

- Operation from 2.7 V to 5.0 V Single-Sided Power Supply
- LMV321 Single Available in Ultra Small 5 Pin SC70 Package
- No Output Crossover Distortion
- Rail-to-Rail Output
- Low Quiescent Current: LMV358 Dual – 220  $\mu$ A, Max per Channel
- No Output Phase-Reversal from Overdriven Input
- NCV Prefix for Automotive and Other Applications Requiring Unique Site and Control Change Requirements; AEC-Q100 Qualified and PPAP Capable
- These Devices are Pb-Free, Halogen Free/BFR Free and are RoHS Compliant

### Typical Applications

- Notebook Computers and PDA's
- Portable Battery-Operated Instruments
- Active Filters



ON Semiconductor®

[www.onsemi.com](http://www.onsemi.com)

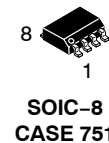
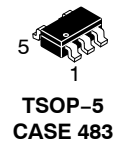
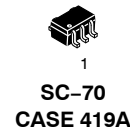

### ORDERING AND MARKING INFORMATION

See detailed ordering and shipping information in the package dimensions section on page 12 of this data sheet.

# LMV321, NCV321, LMV358, LMV324

## MARKING DIAGRAMS

SC-70

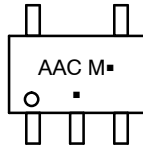

AAC = Specific Device Code  
 M = Date Code  
 ■ = Pb-Free Package  
 (Note: Microdot may be in either location)

TSOP-5

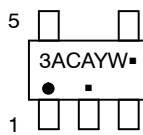

3AC = Specific Device Code  
 A = Assembly Location  
 Y = Year  
 W = Work Week  
 ■ = Pb-Free Package  
 (Note: Microdot may be in either location)

Micro8

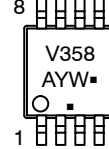

V358 = Specific Device Code  
 A = Assembly Location  
 Y = Year  
 W = Work Week  
 ■ = Pb-Free Package  
 (Note: Microdot may be in either location)

SOIC-8

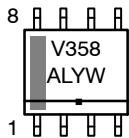

V358 = Specific Device Code  
 A = Assembly Location  
 L = Wafer Lot  
 Y = Year  
 W = Work Week  
 ■ = Pb-Free Package

UDFN8

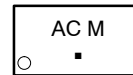

AC = Specific Device Code  
 M = Date Code  
 ■ = Pb-Free Package

SOIC-14

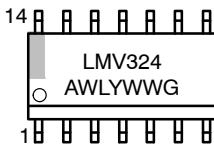

LMV324 = Specific Device Code  
 A = Assembly Location  
 WL = Wafer Lot  
 Y = Year  
 WW = Work Week  
 G = Pb-Free Package

TSSOP-14

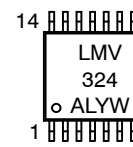

LMV324 = Specific Device Code  
 A = Assembly Location  
 L = Wafer Lot  
 Y = Year  
 W = Work Week  
 ■ = Pb-Free Package

## PIN CONNECTIONS

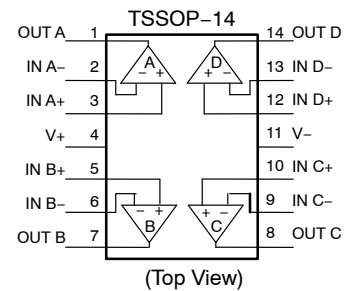
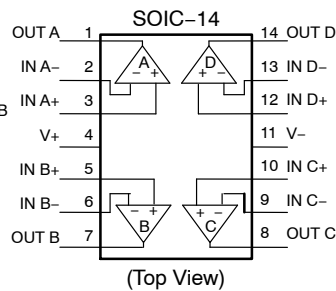
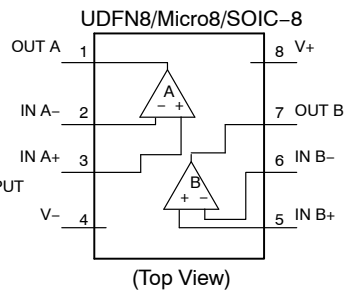
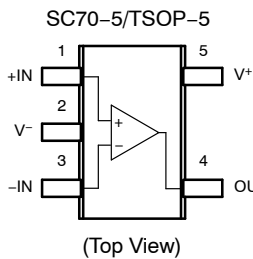

# LMV321, NCV321, LMV358, LMV324

## MAXIMUM RATINGS

Symbol	Rating	Value	Unit
$V_S$	Supply Voltage (Operating Range $V_S = 2.7\text{ V to }5.5\text{ V}$ )	5.5	V
$V_{IDR}$	Input Differential Voltage	$\pm$ Supply Voltage	V
$V_{ICR}$	Input Common Mode Voltage Range	$-0.5\text{ to }(V+) + 0.5$	V
	Maximum Input Current	10	mA
$t_{SO}$	Output Short Circuit (Note 1)	Continuous	
$T_J$	Maximum Junction Temperature	150	$^{\circ}\text{C}$
$T_A$	Operating Ambient Temperature Range	LMV321, LMV358, LMV324 LMV321, LMV358I NCV321 (Note 2)	$-40\text{ to }85$ $-40\text{ to }125$ $-40\text{ to }125$ $^{\circ}\text{C}$ $^{\circ}\text{C}$ $^{\circ}\text{C}$
$\theta_{JA}$	Thermal Resistance:		$^{\circ}\text{C}/\text{W}$
	SC-70	280	
	Micro8	238	
	TSOP-5	333	
	UDFN8 (1.2 mm x 1.8 mm x 0.5 mm)	350	
	SOIC-8	212	
	SOIC-14	156	
	TSSOP-14	190	
$T_{stg}$	Storage Temperature	$-65\text{ to }150$	$^{\circ}\text{C}$
	Mounting Temperature (Infrared or Convection $-20\text{ sec}$ )	260	$^{\circ}\text{C}$
$V_{ESD}$	ESD Tolerance (Note 3)		V
	LMV321, LMV321I, NCV321		
	Machine Model	100	
	Human Body Model	1000	
LMV358/358I/324			
Machine Model	100		
Human Body Mode	2000		

Stresses exceeding those listed in the Maximum Ratings table may damage the device. If any of these limits are exceeded, device functionality should not be assumed, damage may occur and reliability may be affected.

1. Continuous short-circuit operation to ground at elevated ambient temperature can result in exceeding the maximum allowed junction temperature of  $150^{\circ}\text{C}$ . Output currents in excess of 45 mA over long term may adversely affect reliability. Shorting output to either  $V+$  or  $V-$  will adversely affect reliability.
2. NCV prefix is qualified for automotive usage.
3. Human Body Model, applicable std. MIL-STD-883, Method 3015.7  
Machine Model, applicable std. JESD22-A115-A (ESD MM std. of JEDEC)  
Field-Induced Charge-Device Model, applicable std. JESD22-C101-C (ESD FICDM std. of JEDEC).

## LMV321, NCV321, LMV358, LMV324

**2.7 V DC ELECTRICAL CHARACTERISTICS** (Unless otherwise specified, all limits are guaranteed for  $T_A = 25^\circ\text{C}$ ,  $V^+ = 2.7\text{ V}$ ,  $R_L = 1\text{ M}\Omega$ ,  $V^- = 0\text{ V}$ ,  $V_O = V^+/2$ )

Parameter	Symbol	Condition	Min	Typ	Max	Unit
Input Offset Voltage	$V_{IO}$	$T_A = T_{Low}$ to $T_{High}$ (Note 4)		1.7	9	mV
Input Offset Voltage Average Drift	$ICV_{OS}$	$T_A = T_{Low}$ to $T_{High}$ (Note 4)		5		$\mu\text{V}/^\circ\text{C}$
Input Bias Current	$I_B$	$T_A = T_{Low}$ to $T_{High}$ (Note 4)		<1		nA
Input Offset Current	$I_{IO}$	$T_A = T_{Low}$ to $T_{High}$ (Note 4)		<1		nA
Common Mode Rejection Ratio	CMRR	$0\text{ V} \leq V_{CM} \leq 1.7\text{ V}$	50	63		dB
Power Supply Rejection Ratio	PSRR	$2.7\text{ V} \leq V^+ \leq 5\text{ V}$ , $V_O = 1\text{ V}$	50	60		dB
Input Common-Mode Voltage Range	$V_{CM}$	For CMRR $\geq 50\text{ dB}$	0 to 1.7	-0.2 to 1.9		V
Output Swing	$V_{OH}$	$R_L = 10\text{ k}\Omega$ to $1.35\text{ V}$	$V_{CC} - 100$	$V_{CC} - 10$		mV
	$V_{OL}$	$R_L = 10\text{ k}\Omega$ to $1.35\text{ V}$ (Note 5)		60	180	mV
Supply Current LMV321, NCV321 LMV358/LMV358I (Both Amplifiers) LMV324 (4 Amplifiers)	$I_{CC}$			80 140 260	185 340 680	$\mu\text{A}$

**2.7 V AC ELECTRICAL CHARACTERISTICS** (Unless otherwise specified, all limits are guaranteed for  $T_A = 25^\circ\text{C}$ ,  $V^+ = 2.7\text{ V}$ ,  $R_L = 1\text{ M}\Omega$ ,  $V^- = 0\text{ V}$ ,  $V_O = V^+/2$ )

Parameter	Symbol	Condition	Min	Typ	Max	Unit
Gain Bandwidth Product	GBWP	$C_L = 200\text{ pF}$		1		MHz
Phase Margin	$\Theta_m$			60		$^\circ$
Gain Margin	$G_m$			10		dB
Input-Referred Voltage Noise	$e_n$	$f = 50\text{ kHz}$		50		$\text{nV}/\sqrt{\text{Hz}}$

Product parametric performance is indicated in the Electrical Characteristics for the listed test conditions, unless otherwise noted. Product performance may not be indicated by the Electrical Characteristics if operated under different conditions.

4. For LMV321, LMV358, LMV324:  $T_A = -40^\circ\text{C}$  to  $+85^\circ\text{C}$   
For LMV321I, LMV358I, NCV321:  $T_A = -40^\circ\text{C}$  to  $+125^\circ\text{C}$ .
5. Guaranteed by design and/or characterization.

## LMV321, NCV321, LMV358, LMV324

**5.0 V DC ELECTRICAL CHARACTERISTICS** (Unless otherwise specified, all limits are guaranteed for  $T_A = 25^\circ\text{C}$ ,  $V^+ = 5.0\text{ V}$ ,  $R_L = 1\text{ M}\Omega$ ,  $V^- = 0\text{ V}$ ,  $V_O = V^+/2$ )

Parameter	Symbol	Condition	Min	Typ	Max	Unit
Input Offset Voltage	$V_{IO}$	$T_A = T_{Low}$ to $T_{High}$ (Note 6)		1.7	9	mV
Input Offset Voltage Average Drift	$T_C V_{IO}$	$T_A = T_{Low}$ to $T_{High}$ (Note 6)		5		$\mu\text{V}/^\circ\text{C}$
Input Bias Current (Note 7)	$I_B$	$T_A = T_{Low}$ to $T_{High}$ (Note 6)		< 1		nA
Input Offset Current (Note 7)	$I_{IO}$	$T_A = T_{Low}$ to $T_{High}$ (Note 6)		< 1		nA
Common Mode Rejection Ratio	CMRR	$0\text{ V} \leq V_{CM} \leq 4\text{ V}$	50	65		dB
Power Supply Rejection Ratio	PSRR	$2.7\text{ V} \leq V^+ \leq 5\text{ V}$ , $V_O = 1\text{ V}$ , $V_{CM} = 1\text{ V}$	50	60		dB
Input Common-Mode Voltage Range	$V_{CM}$	For CMRR $\geq 50\text{ dB}$	0 to 4	-0.2 to 4.2		V
Large Signal Voltage Gain (Note 7)	$A_V$	$R_L = 2\text{ k}\Omega$	15	100		V/mV
		$T_A = T_{Low}$ to $T_{High}$ (Note 6)	10			
Output Swing	$V_{OH}$	$R_L = 2\text{ k}\Omega$ to $2.5\text{ V}$ $T_A = T_{Low}$ to $T_{High}$ (Note 6)	$V_{CC} - 300$ $V_{CC} - 400$	$V_{CC} - 40$		mV
	$V_{OL}$	$R_L = 2\text{ k}\Omega$ to $2.5\text{ V}$ (Note 7) $T_A = T_{Low}$ to $T_{High}$ (Note 6)		120	300 400	mV
	$V_{OH}$	$R_L = 10\text{ k}\Omega$ to $2.5\text{ V}$ (Note 7) $T_A = T_{Low}$ to $T_{High}$ (Note 6)	$V_{CC} - 100$ $V_{CC} - 200$			mV
	$V_{OL}$	$R_L = 10\text{ k}\Omega$ to $2.5\text{ V}$ $T_A = T_{Low}$ to $T_{High}$ (Note 6)		65	180 280	mV
Output Short Circuit Current	$I_O$	Sourcing = $V_O = 0\text{ V}$ (Note 7)	10	60		mA
		Sinking = $V_O = 5\text{ V}$ (Note 7)	10	160		
Supply Current	$I_{CC}$	LMV321 $T_A = T_{Low}$ to $T_{High}$ (Note 6)		130	250 350	$\mu\text{A}$
		NCV321 $T_A = T_{Low}$ to $T_{High}$ (Note 6)		130	250 350	
		LMV358/358I Both Amplifiers $T_A = T_{Low}$ to $T_{High}$ (Note 6)		210	440 615	
		LMV324 All Four Amplifiers $T_A = T_{Low}$ to $T_{High}$ (Note 6)		410	830 1160	

**5.0 V AC ELECTRICAL CHARACTERISTICS** (Unless otherwise specified, all limits are guaranteed for  $T_A = 25^\circ\text{C}$ ,  $V^+ = 5.0\text{ V}$ ,  $R_L = 1\text{ M}\Omega$ ,  $V^- = 0\text{ V}$ ,  $V_O = V^+/2$ )

Parameter	Symbol	Condition	Min	Typ	Max	Unit
Slew Rate	$S_R$			1		V/ $\mu\text{s}$
Gain Bandwidth Product	GBWP	$C_L = 200\text{ pF}$		1		MHz
Phase Margin	$\theta_m$			60		$^\circ$
Gain Margin	$G_m$			10		dB
Input-Referred Voltage Noise	$e_n$	$f = 50\text{ kHz}$		50		$\text{nV}/\sqrt{\text{Hz}}$

Product parametric performance is indicated in the Electrical Characteristics for the listed test conditions, unless otherwise noted. Product performance may not be indicated by the Electrical Characteristics if operated under different conditions.

6. For LMV321, LMV358, LMV324:  $T_A = -40^\circ\text{C}$  to  $+85^\circ\text{C}$   
 For LMV321I, LMV358I, NCV321:  $T_A = -40^\circ\text{C}$  to  $+125^\circ\text{C}$ .
7. Guaranteed by design and/or characterization.

TYPICAL CHARACTERISTICS

( $T_A = 25^\circ\text{C}$  and  $V_S = 5\text{ V}$  unless otherwise specified)

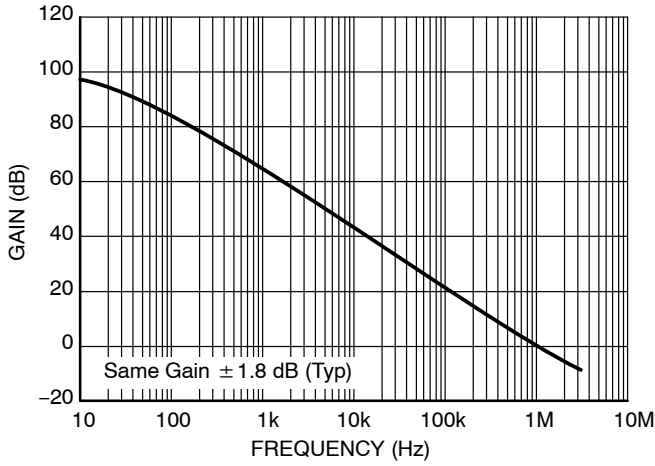

Figure 1. Open Loop Frequency Response  
( $R_L = 2\text{ k}\Omega$ ,  $T_A = 25^\circ\text{C}$ ,  $V_S = 5\text{ V}$ )

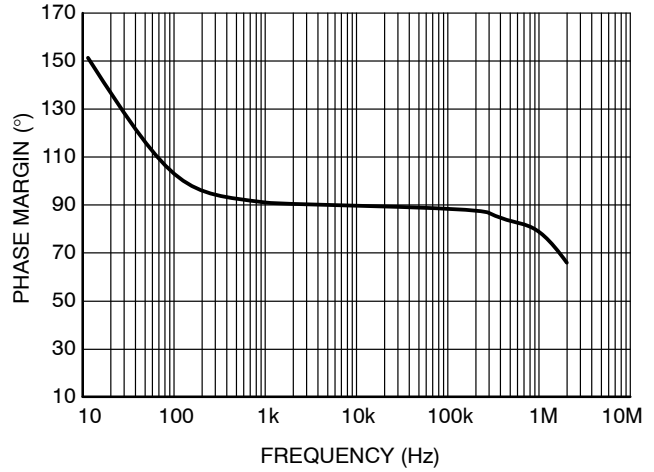

Figure 2. Open Loop Phase Margin  
( $R_L = 2\text{ k}\Omega$ ,  $T_A = 25^\circ\text{C}$ ,  $V_S = 5\text{ V}$ )

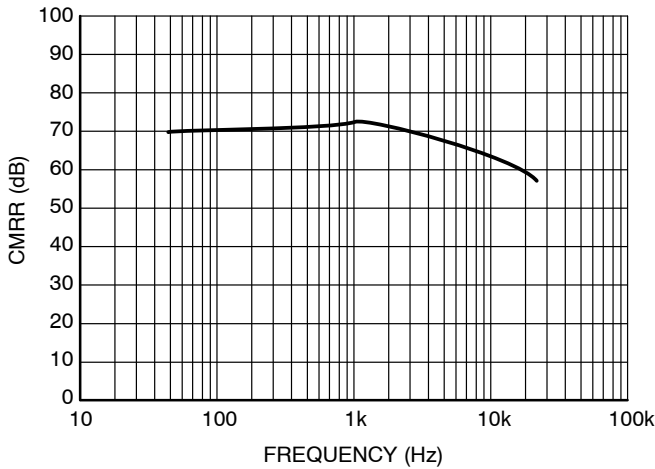

Figure 3. CMRR vs. Frequency  
( $R_L = 5\text{ k}\Omega$ ,  $V_S = 5\text{ V}$ )

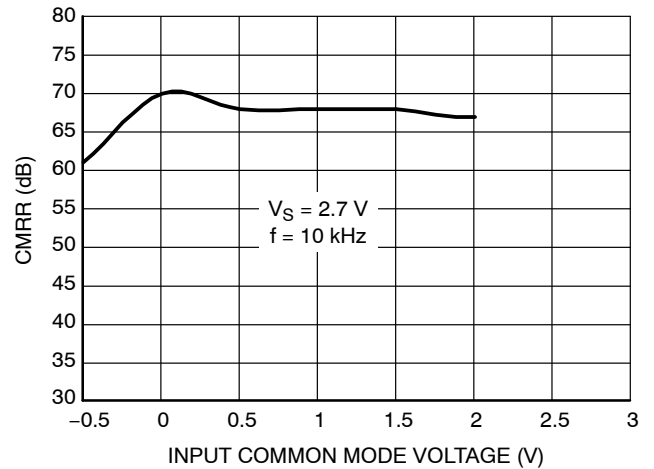

Figure 4. CMRR vs. Input Common Mode Voltage

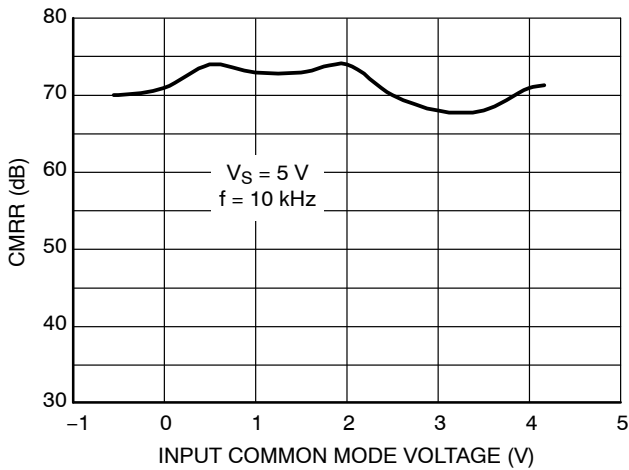

Figure 5. CMRR vs. Input Common Mode Voltage

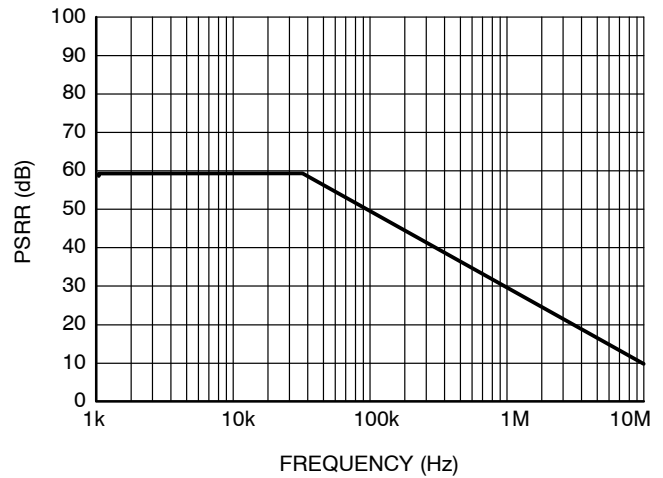
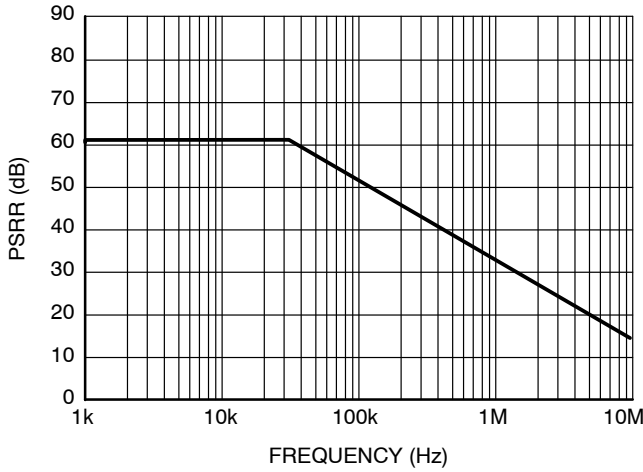

Figure 6. PSRR vs. Frequency  
( $R_L = 5\text{ k}\Omega$ ,  $V_S = 2.7\text{ V}$ , +PSRR)

# LMV321, NCV321, LMV358, LMV324

## TYPICAL CHARACTERISTICS

( $T_A = 25^\circ\text{C}$  and  $V_S = 5\text{ V}$  unless otherwise specified)



**Figure 7. PSRR vs. Frequency**  
( $R_L = 5\text{ k}\Omega$ ,  $V_S = 2.7\text{ V}$ , -PSRR)

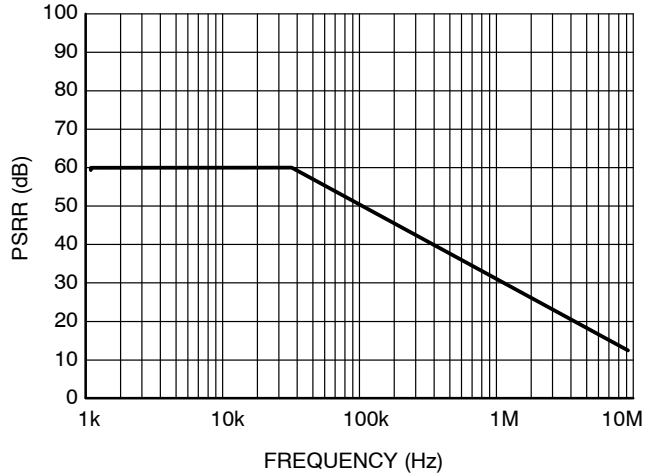

**Figure 8. PSRR vs. Frequency**  
( $R_L = 5\text{ k}\Omega$ ,  $V_S = 5\text{ V}$ , +PSRR)

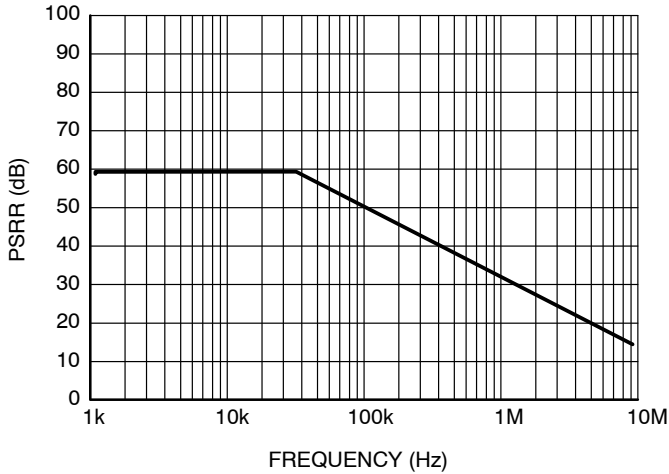

**Figure 9. PSRR vs. Frequency**  
( $R_L = 5\text{ k}\Omega$ ,  $V_S = 5\text{ V}$ , -PSRR)

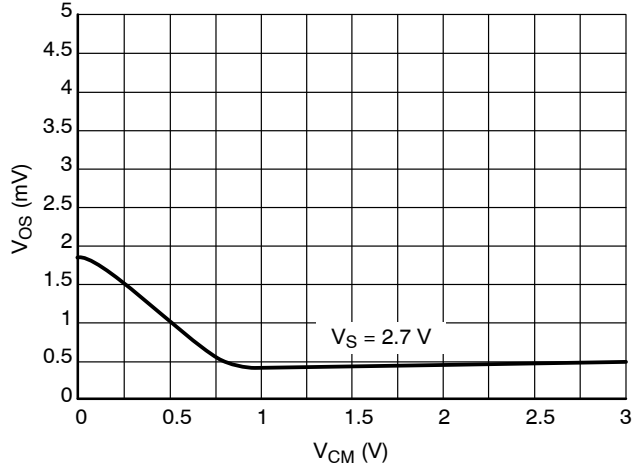

**Figure 10.  $V_{OS}$  vs. CMR**

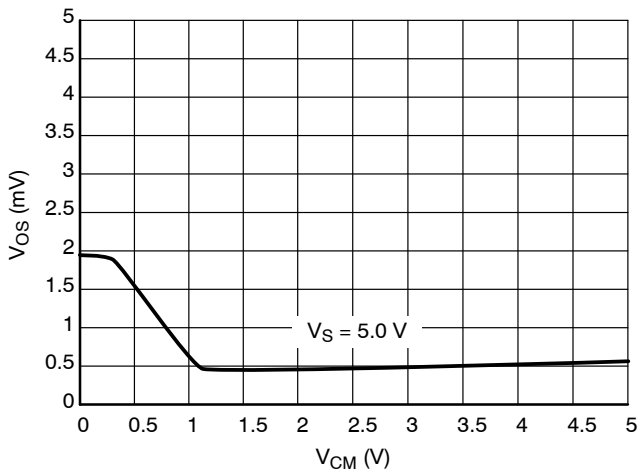

**Figure 11.  $V_{OS}$  vs. CMR**

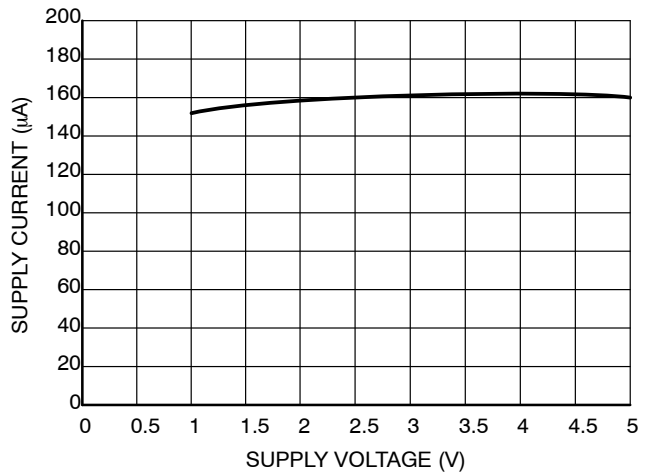
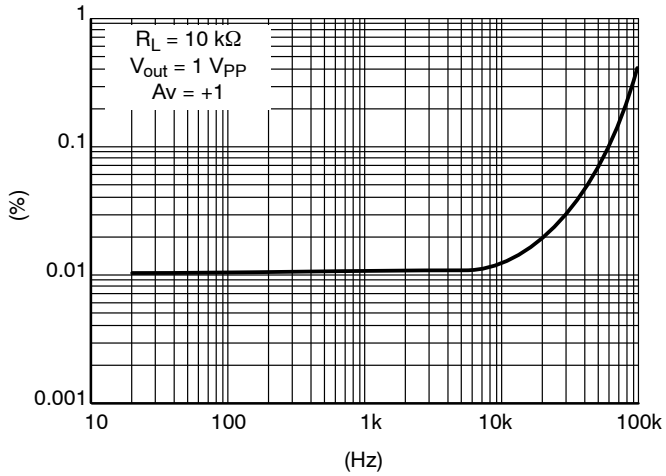

**Figure 12. Supply Current vs. Supply Voltage**

# LMV321, NCV321, LMV358, LMV324

## TYPICAL CHARACTERISTICS

( $T_A = 25^\circ\text{C}$  and  $V_S = 5\text{ V}$  unless otherwise specified)



**Figure 13. THD+N vs Frequency**

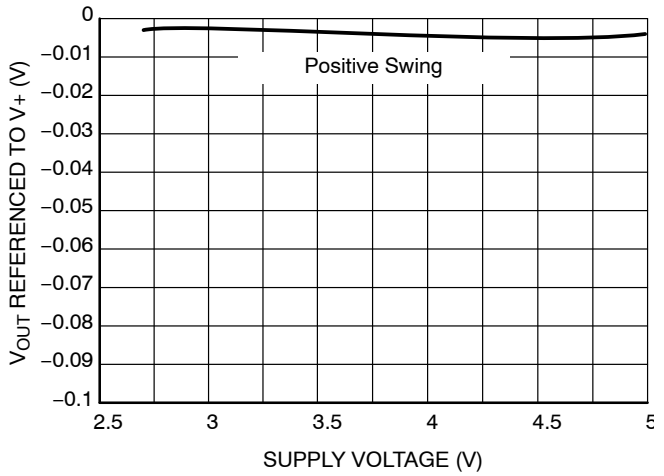

**Figure 14. Output Voltage Swing vs Supply Voltage ( $R_L = 10\text{k}$ )**

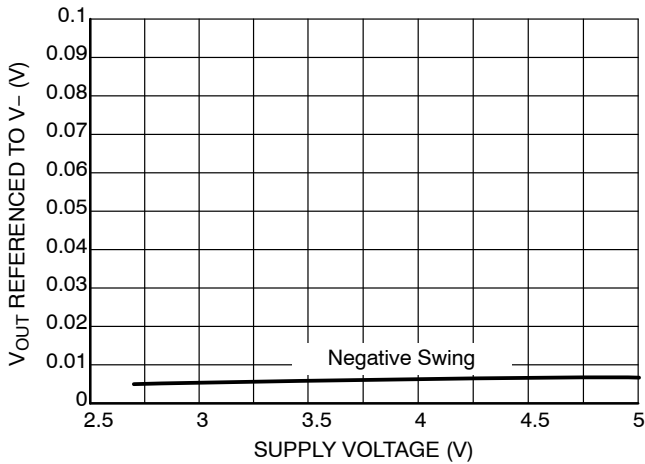

**Figure 15. Output Voltage Swing vs Supply Voltage ( $R_L = 10\text{k}$ )**

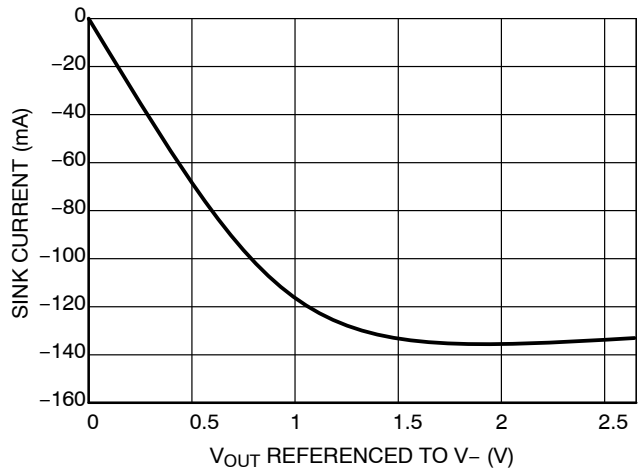

**Figure 16. Sink Current vs. Output Voltage**  
 $V_S = 2.7\text{ V}$

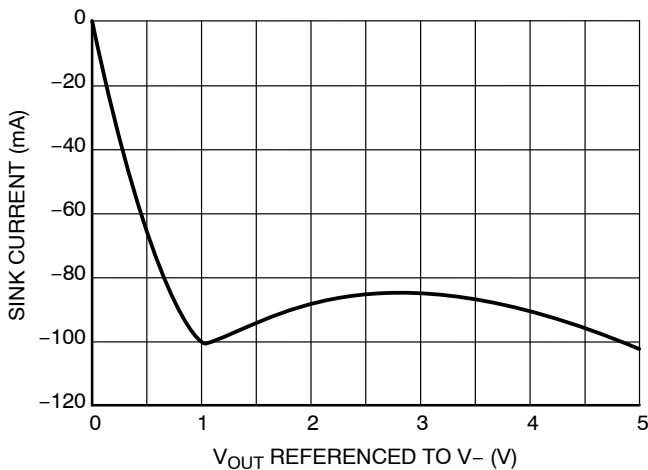

**Figure 17. Sink Current vs. Output Voltage**  
 $V_S = 5.0\text{ V}$

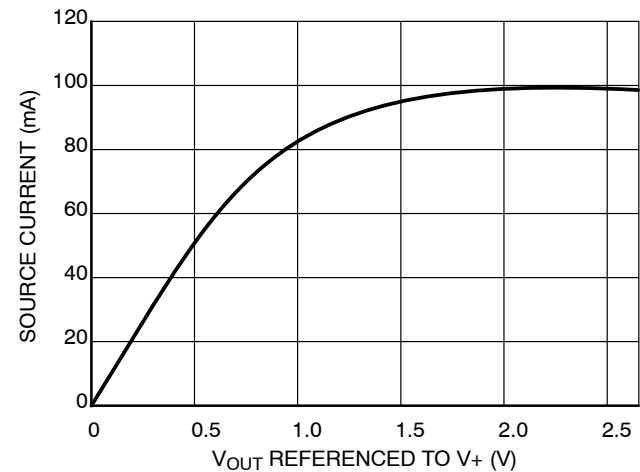

**Figure 18. Source Current vs. Output Voltage**  
 $V_S = 2.7\text{ V}$



# LMV321, NCV321, LMV358, LMV324

## TYPICAL CHARACTERISTICS

( $T_A = 25^\circ\text{C}$  and  $V_S = 5\text{ V}$  unless otherwise specified)

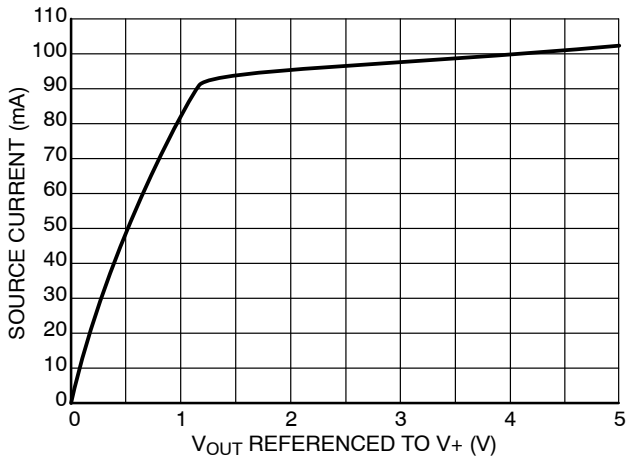

**Figure 19. Source Current vs. Output Voltage**  
 $V_S = 5.0\text{ V}$

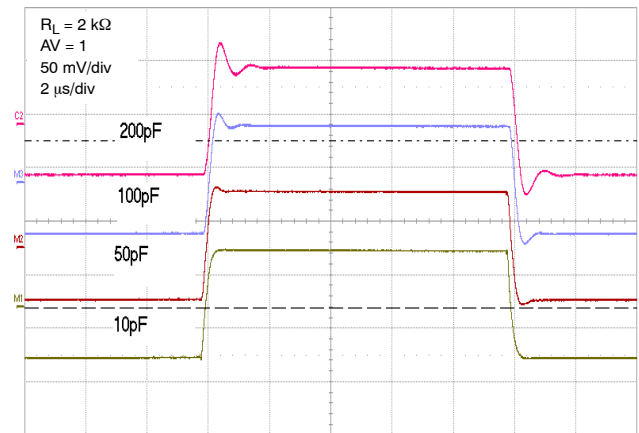

**Figure 20. Settling Time vs. Capacitive Load**

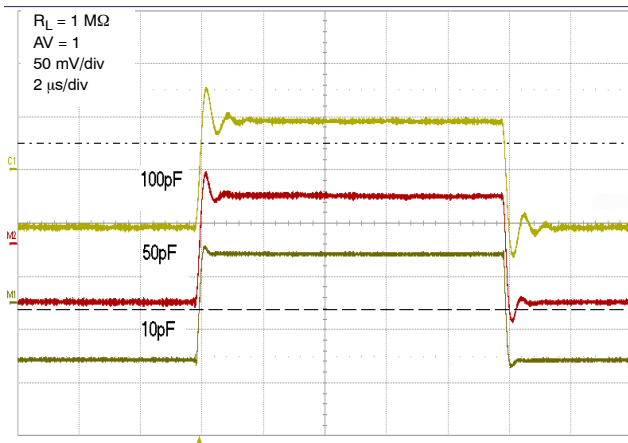

**Figure 21. Settling Time vs. Capacitive Load**

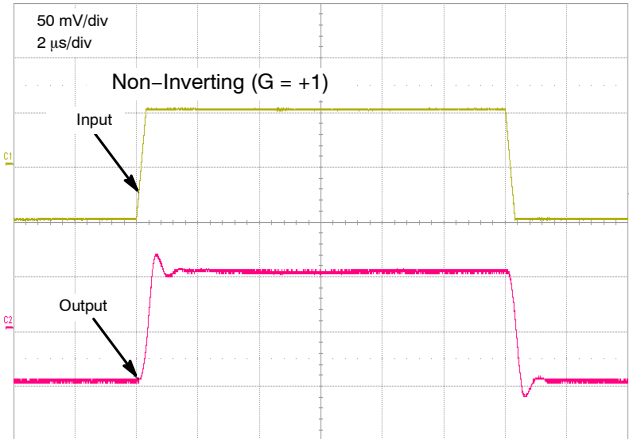

**Figure 22. Step Response - Small Signal**

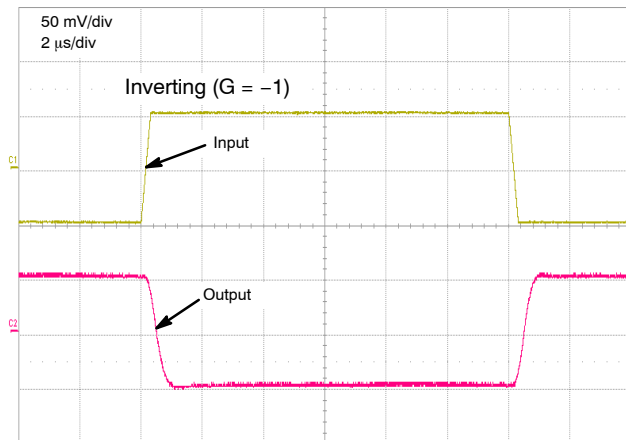

**Figure 23. Step Response - Small Signal**

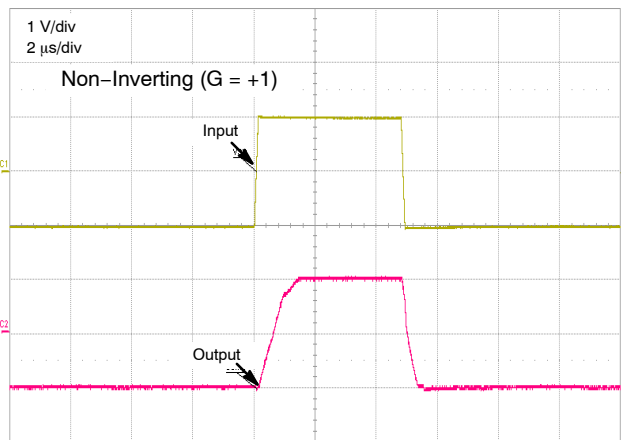
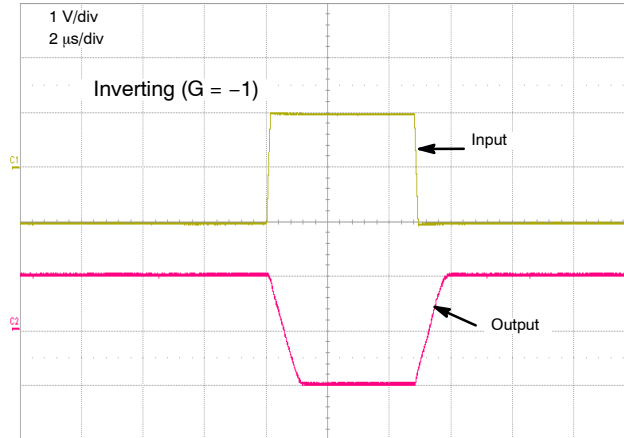

**Figure 24. Step Response - Large Signal**

# LMV321, NCV321, LMV358, LMV324

## TYPICAL CHARACTERISTICS

( $T_A = 25^\circ\text{C}$  and  $V_S = 5\text{ V}$  unless otherwise specified)



**Figure 25. Step Response – Large Signal**

APPLICATIONS

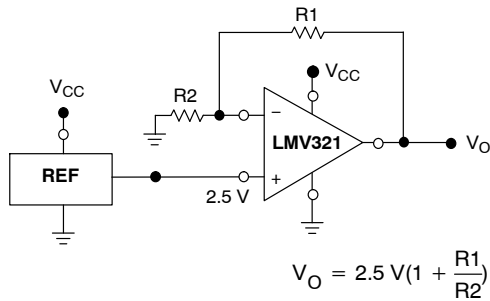

Figure 26. Voltage Reference

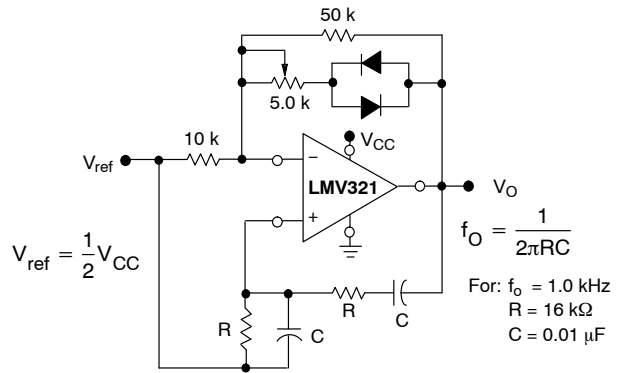

Figure 27. Wien Bridge Oscillator

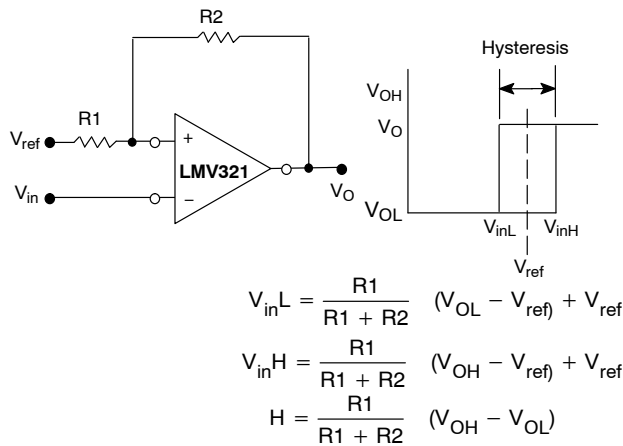
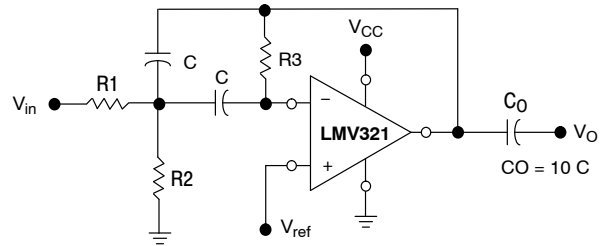

Figure 28. Comparator with Hysteresis



Given:  $f_o$  = center frequency  
 $A(f_o)$  = gain at center frequency

Choose value  $f_o, C$   
 Then:  $R_3 = \frac{Q}{\pi f_o C}$   
 $R_1 = \frac{R_3}{2 A(f_o)}$   
 $R_2 = \frac{R_1 R_3}{4Q^2 R_1 - R_3}$

For less than 10% error from operational amplifier,  
 $((Q_o f_o)/BW) < 0.1$  where  $f_o$  and BW are expressed in Hz.  
 If source impedance varies, filter may be preceded with  
 voltage follower buffer to stabilize filter parameters.

Figure 29. Multiple Feedback Bandpass Filter

## LMV321, NCV321, LMV358, LMV324

### ORDERING INFORMATION

Order Number	Number of Channels	Specific Device Marking	Package Type	Shipping <sup>†</sup>
LMV321SQ3T2G	Single	AAC	SC-70 (Pb-Free)	3000 / Tape & Reel
LMV321SN3T1G	Single	3AC	TSOP-5 (Pb-Free)	3000 / Tape & Reel
LMV321ISN3T1G	Single	3AC	TSOP-5 (Pb-Free)	3000 / Tape & Reel
NCV321SN3T1G*	Single	3AC	TSOP-5 (Pb-Free)	3000 / Tape & Reel
LMV358DMR2G	Dual	V358	Micro8 (Pb-Free)	4000 / Tape & Reel
LMV358MUTAG	Dual	AC	UDFN8 (Pb-Free)	3000 / Tape & Reel
LMV358DR2G	Dual	V358	SOIC-8 (Pb-Free)	2500 / Tape & Reel
LMV358IDR2G	Dual	V358	SOIC-8 (Pb-Free)	2500 / Tape & Reel
LMV324DR2G	Quad	LMV324	SOIC-14 (Pb-Free)	2500 / Tape & Reel
LMV324DTBR2G	Quad	LMV324	TSSOP-14 (Pb-Free)	2500 / Tape & Reel

<sup>†</sup>For information on tape and reel specifications, including part orientation and tape sizes, please refer to our Tape and Reel Packaging Specifications Brochure, BRD8011/D.

\*NCV Prefix for Automotive and Other Applications Requiring Unique Site and Control Change Requirements; AEC-Q100 Qualified and PPAP Capable.

# MECHANICAL CASE OUTLINE

## PACKAGE DIMENSIONS

ON Semiconductor®



SCALE 2:1

SC-88A (SC-70-5/SOT-353)  
CASE 419A-02  
ISSUE L

DATE 17 JAN 2013

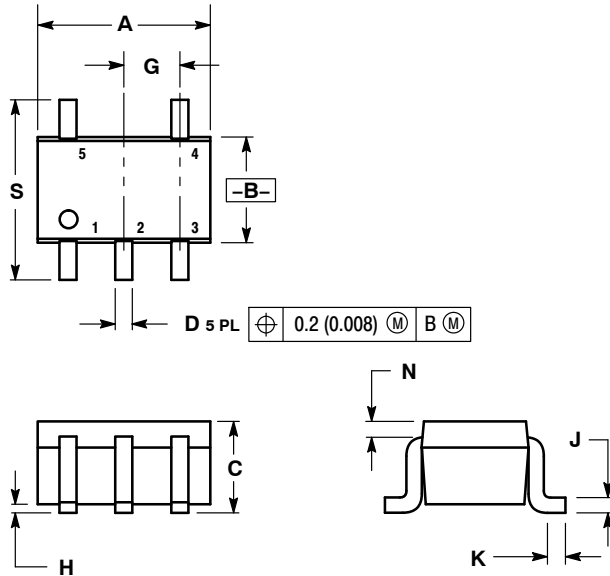

### SOLDER FOOTPRINT

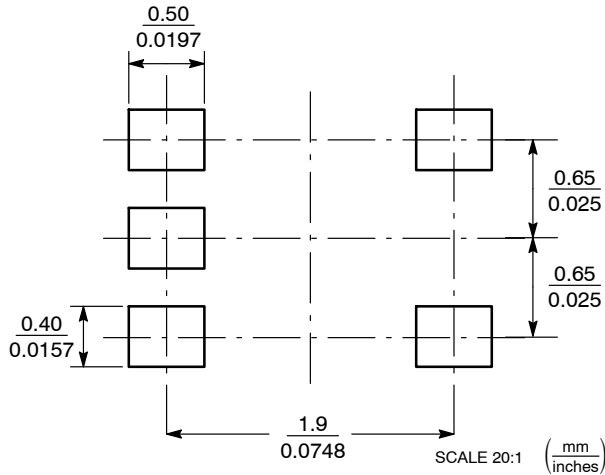

NOTES:

1. DIMENSIONING AND TOLERANCING PER ANSI Y14.5M, 1982.
2. CONTROLLING DIMENSION: INCH.
3. 419A-01 OBSOLETE. NEW STANDARD 419A-02.
4. DIMENSIONS A AND B DO NOT INCLUDE MOLD FLASH, PROTRUSIONS, OR GATE BURRS.

DIM	INCHES		MILLIMETERS	
	MIN	MAX	MIN	MAX
A	0.071	0.087	1.80	2.20
B	0.045	0.053	1.15	1.35
C	0.031	0.043	0.80	1.10
D	0.004	0.012	0.10	0.30
G	0.026 BSC		0.65 BSC	
H	---	0.004	---	0.10
J	0.004	0.010	0.10	0.25
K	0.004	0.012	0.10	0.30
N	0.008 REF		0.20 REF	
S	0.079	0.087	2.00	2.20

### GENERIC MARKING DIAGRAM\*

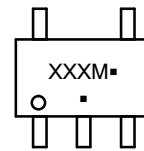

- XXX = Specific Device Code
- M = Date Code
- = Pb-Free Package

(Note: Microdot may be in either location)

\*This information is generic. Please refer to device data sheet for actual part marking. Pb-Free indicator, "G" or microdot "■", may or may not be present. Some products may not follow the Generic Marking.

- |  |  |  |  |  |
|--|--|--|--|--|
| <p>STYLE 1:<br/>PIN 1. BASE<br/>2. EMITTER<br/>3. BASE<br/>4. COLLECTOR<br/>5. COLLECTOR</p>                   | <p>STYLE 2:<br/>PIN 1. ANODE<br/>2. EMITTER<br/>3. BASE<br/>4. COLLECTOR<br/>5. CATHODE</p>  | <p>STYLE 3:<br/>PIN 1. ANODE 1<br/>2. N/C<br/>3. ANODE 2<br/>4. CATHODE 2<br/>5. CATHODE 1</p> | <p>STYLE 4:<br/>PIN 1. SOURCE 1<br/>2. DRAIN 1/2<br/>3. SOURCE 1<br/>4. GATE 1<br/>5. GATE 2</p> | <p>STYLE 5:<br/>PIN 1. CATHODE<br/>2. COMMON ANODE<br/>3. CATHODE 2<br/>4. CATHODE 3<br/>5. CATHODE 4</p>  |
| <p>STYLE 6:<br/>PIN 1. EMITTER 2<br/>2. BASE 2<br/>3. EMITTER 1<br/>4. COLLECTOR<br/>5. COLLECTOR 2/BASE 1</p> | <p>STYLE 7:<br/>PIN 1. BASE<br/>2. EMITTER<br/>3. BASE<br/>4. COLLECTOR<br/>5. COLLECTOR</p> | <p>STYLE 8:<br/>PIN 1. CATHODE<br/>2. COLLECTOR<br/>3. N/C<br/>4. BASE<br/>5. EMITTER</p>      | <p>STYLE 9:<br/>PIN 1. ANODE<br/>2. CATHODE<br/>3. ANODE<br/>4. ANODE<br/>5. ANODE</p>           | <p>Note: Please refer to datasheet for style callout. If style type is not called out in the datasheet refer to the device datasheet pinout or pin assignment.</p> |

DOCUMENT NUMBER:	98ASB42984B	Electronic versions are uncontrolled except when accessed directly from the Document Repository. Printed versions are uncontrolled except when stamped "CONTROLLED COPY" in red.
DESCRIPTION:	SC-88A (SC-70-5/SOT-353)	PAGE 1 OF 1

ON Semiconductor and ON are trademarks of Semiconductor Components Industries, LLC dba ON Semiconductor or its subsidiaries in the United States and/or other countries. ON Semiconductor reserves the right to make changes without further notice to any products herein. ON Semiconductor makes no warranty, representation or guarantee regarding the suitability of its products for any particular purpose, nor does ON Semiconductor assume any liability arising out of the application or use of any product or circuit, and specifically disclaims any and all liability, including without limitation special, consequential or incidental damages. ON Semiconductor does not convey any license under its patent rights nor the rights of others.

# MECHANICAL CASE OUTLINE

## PACKAGE DIMENSIONS

ON Semiconductor®



SCALE 2:1

### TSOP-5 CASE 483 ISSUE N

DATE 12 AUG 2020

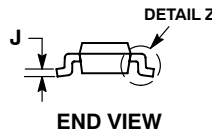
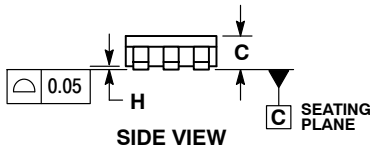
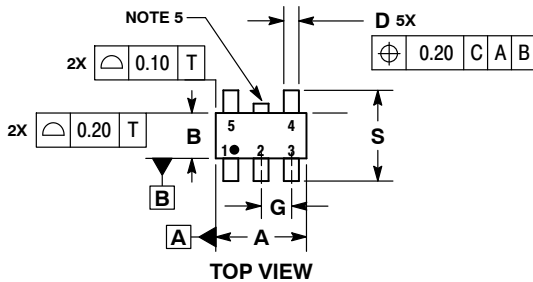

NOTES:

1. DIMENSIONING AND TOLERANCING PER ASME Y14.5M, 1994.
2. CONTROLLING DIMENSION: MILLIMETERS.
3. MAXIMUM LEAD THICKNESS INCLUDES LEAD FINISH THICKNESS. MINIMUM LEAD THICKNESS IS THE MINIMUM THICKNESS OF BASE MATERIAL.
4. DIMENSIONS A AND B DO NOT INCLUDE MOLD FLASH, PROTRUSIONS, OR GATE BURRS. MOLD FLASH, PROTRUSIONS, OR GATE BURRS SHALL NOT EXCEED 0.15 PER SIDE. DIMENSION A.
5. OPTIONAL CONSTRUCTION: AN ADDITIONAL TRIMMED LEAD IS ALLOWED IN THIS LOCATION. TRIMMED LEAD NOT TO EXTEND MORE THAN 0.2 FROM BODY.

DIM	MILLIMETERS	
	MIN	MAX
A	2.85	3.15
B	1.35	1.65
C	0.90	1.10
D	0.25	0.50
G	0.95 BSC	
H	0.01	0.10
J	0.10	0.26
K	0.20	0.60
M	0°	10°
S	2.50	3.00

#### SOLDERING FOOTPRINT\*

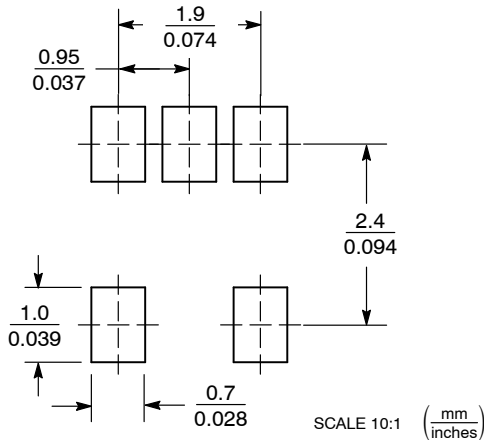

\*For additional information on our Pb-Free strategy and soldering details, please download the ON Semiconductor Soldering and Mounting Techniques Reference Manual, SOLDERRM/D.

#### GENERIC MARKING DIAGRAM\*

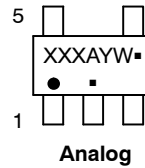

Analog

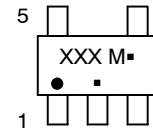

Discrete/Logic

- XXX = Specific Device Code  
 A = Assembly Location  
 Y = Year  
 W = Work Week  
 ■ = Pb-Free Package
- XXX = Specific Device Code  
 M = Date Code  
 ■ = Pb-Free Package

(Note: Microdot may be in either location)

\*This information is generic. Please refer to device data sheet for actual part marking. Pb-Free indicator, "G" or microdot "■", may or may not be present.

<b>DOCUMENT NUMBER:</b>	<b>98ARB18753C</b>	Electronic versions are uncontrolled except when accessed directly from the Document Repository. Printed versions are uncontrolled except when stamped "CONTROLLED COPY" in red.
<b>DESCRIPTION:</b>	<b>TSOP-5</b>	<b>PAGE 1 OF 1</b>

ON Semiconductor and are trademarks of Semiconductor Components Industries, LLC dba ON Semiconductor or its subsidiaries in the United States and/or other countries. ON Semiconductor reserves the right to make changes without further notice to any products herein. ON Semiconductor makes no warranty, representation or guarantee regarding the suitability of its products for any particular purpose, nor does ON Semiconductor assume any liability arising out of the application or use of any product or circuit, and specifically disclaims any and all liability, including without limitation special, consequential or incidental damages. ON Semiconductor does not convey any license under its patent rights nor the rights of others.

# MECHANICAL CASE OUTLINE

## PACKAGE DIMENSIONS

ON Semiconductor®



SCALE 4:1

UDFN8 1.8x1.2, 0.4P  
CASE 517AJ-01  
ISSUE O

DATE 08 NOV 2006

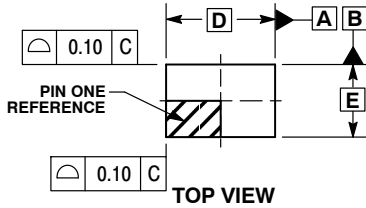

TOP VIEW

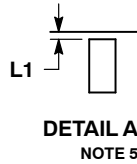

DETAIL A  
NOTE 5

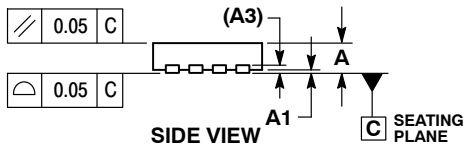

SIDE VIEW

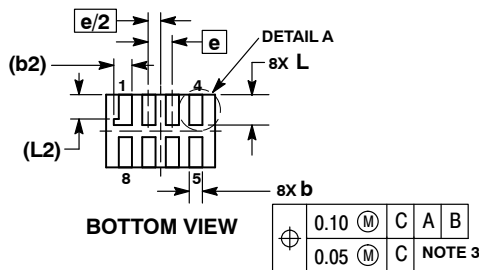

BOTTOM VIEW

⊕	0.10	(M)	C	A	B
	0.05	(M)	C		

NOTE 3

NOTES:

- DIMENSIONING AND TOLERANCING PER ASME Y14.5M, 1994.
- CONTROLLING DIMENSION: MILLIMETERS.
- DIMENSION b APPLIES TO PLATED TERMINAL AND IS MEASURED BETWEEN 0.15 AND 0.30 mm FROM TERMINAL TIP.
- MOLD FLASH ALLOWED ON TERMINALS ALONG EDGE OF PACKAGE. FLASH MAY NOT EXCEED 0.03 ONTO BOTTOM SURFACE OF TERMINALS.
- DETAIL A SHOWS OPTIONAL CONSTRUCTION FOR TERMINALS.

DIM	MILLIMETERS	
	MIN	MAX
A	0.45	0.55
A1	0.00	0.05
A3	0.127	REF
b	0.15	0.25
b2	0.30	REF
D	1.80	BSC
E	1.20	BSC
e	0.40	BSC
L	0.45	0.55
L1	0.00	0.03
L2	0.40	REF

GENERIC MARKING DIAGRAM\*

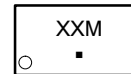

- XX = Specific Device Code
- M = Date Code
- = Pb-Free Package

MOUNTING FOOTPRINT  
SOLDERMASK DEFINED

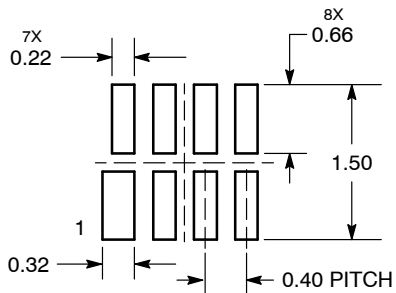

DIMENSIONS: MILLIMETERS

\*This information is generic. Please refer to device data sheet for actual part marking. Pb-Free indicator, "G" or microdot "▪", may or may not be present.

DOCUMENT NUMBER:	98AON23417D	Electronic versions are uncontrolled except when accessed directly from the Document Repository. Printed versions are uncontrolled except when stamped "CONTROLLED COPY" in red.
DESCRIPTION:	UDFN8 1.8X1.2, 0.4P	PAGE 1 OF 1

ON Semiconductor and ON are trademarks of Semiconductor Components Industries, LLC dba ON Semiconductor or its subsidiaries in the United States and/or other countries. ON Semiconductor reserves the right to make changes without further notice to any products herein. ON Semiconductor makes no warranty, representation or guarantee regarding the suitability of its products for any particular purpose, nor does ON Semiconductor assume any liability arising out of the application or use of any product or circuit, and specifically disclaims any and all liability, including without limitation special, consequential or incidental damages. ON Semiconductor does not convey any license under its patent rights nor the rights of others.

# MECHANICAL CASE OUTLINE PACKAGE DIMENSIONS

ON Semiconductor®



SCALE 1:1

SOIC-8 NB  
CASE 751-07  
ISSUE AK

DATE 16 FEB 2011

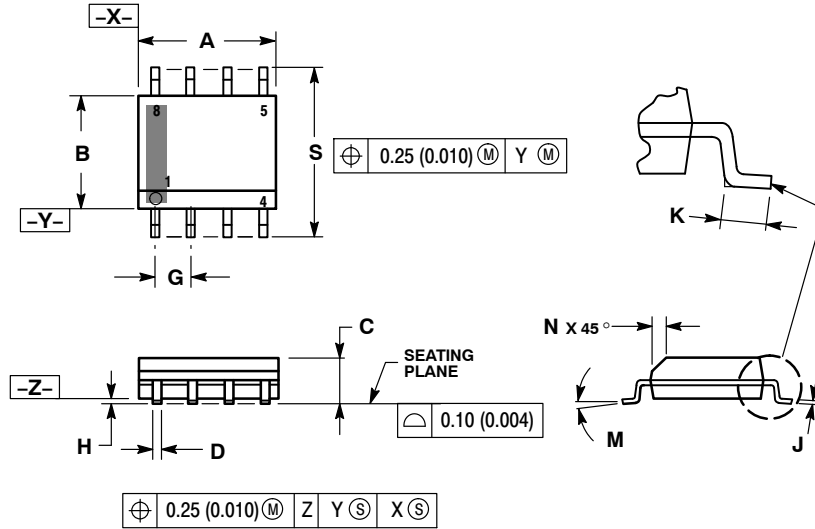

- NOTES:
1. DIMENSIONING AND TOLERANCING PER ANSI Y14.5M, 1982.
  2. CONTROLLING DIMENSION: MILLIMETER.
  3. DIMENSION A AND B DO NOT INCLUDE MOLD PROTRUSION.
  4. MAXIMUM MOLD PROTRUSION 0.15 (0.006) PER SIDE.
  5. DIMENSION D DOES NOT INCLUDE DAMBAR PROTRUSION. ALLOWABLE DAMBAR PROTRUSION SHALL BE 0.127 (0.005) TOTAL IN EXCESS OF THE D DIMENSION AT MAXIMUM MATERIAL CONDITION.
  6. 751-01 THRU 751-06 ARE OBSOLETE. NEW STANDARD IS 751-07.

DIM	MILLIMETERS		INCHES	
	MIN	MAX	MIN	MAX
A	4.80	5.00	0.189	0.197
B	3.80	4.00	0.150	0.157
C	1.35	1.75	0.053	0.069
D	0.33	0.51	0.013	0.020
G	1.27 BSC		0.050 BSC	
H	0.10	0.25	0.004	0.010
J	0.19	0.25	0.007	0.010
K	0.40	1.27	0.016	0.050
M	0°	8°	0°	8°
N	0.25	0.50	0.010	0.020
S	5.80	6.20	0.228	0.244

### SOLDERING FOOTPRINT\*



\*For additional information on our Pb-Free strategy and soldering details, please download the ON Semiconductor Soldering and Mounting Techniques Reference Manual, SOLDERRM/D.

### GENERIC MARKING DIAGRAM\*



XXXXXX = Specific Device Code  
 A = Assembly Location  
 L = Wafer Lot  
 Y = Year  
 W = Work Week  
 ■ = Pb-Free Package

XXXXXX = Specific Device Code  
 A = Assembly Location  
 Y = Year  
 WW = Work Week  
 ■ = Pb-Free Package

\*This information is generic. Please refer to device data sheet for actual part marking. Pb-Free indicator, "G" or microdot "•", may or may not be present. Some products may not follow the Generic Marking.

STYLES ON PAGE 2

DOCUMENT NUMBER:	98ASB42564B	Electronic versions are uncontrolled except when accessed directly from the Document Repository. Printed versions are uncontrolled except when stamped "CONTROLLED COPY" in red.
DESCRIPTION:	SOIC-8 NB	PAGE 1 OF 2

ON Semiconductor and ON are trademarks of Semiconductor Components Industries, LLC dba ON Semiconductor or its subsidiaries in the United States and/or other countries. ON Semiconductor reserves the right to make changes without further notice to any products herein. ON Semiconductor makes no warranty, representation or guarantee regarding the suitability of its products for any particular purpose, nor does ON Semiconductor assume any liability arising out of the application or use of any product or circuit, and specifically disclaims any and all liability, including without limitation special, consequential or incidental damages. ON Semiconductor does not convey any license under its patent rights nor the rights of others.



**SOIC-8 NB**  
**CASE 751-07**  
**ISSUE AK**

DATE 16 FEB 2011

- |  |   |   |   |
|--|---|---|---|
| <p><b>STYLE 1:</b><br/> PIN 1. EMITTER<br/> 2. COLLECTOR<br/> 3. COLLECTOR<br/> 4. EMITTER<br/> 5. EMITTER<br/> 6. BASE<br/> 7. BASE<br/> 8. EMITTER</p>   | <p><b>STYLE 2:</b><br/> PIN 1. COLLECTOR, DIE, #1<br/> 2. COLLECTOR, #1<br/> 3. COLLECTOR, #2<br/> 4. COLLECTOR, #2<br/> 5. BASE, #2<br/> 6. EMITTER, #2<br/> 7. BASE, #1<br/> 8. EMITTER, #1</p>               | <p><b>STYLE 3:</b><br/> PIN 1. DRAIN, DIE #1<br/> 2. DRAIN, #1<br/> 3. DRAIN, #2<br/> 4. DRAIN, #2<br/> 5. GATE, #2<br/> 6. SOURCE, #2<br/> 7. GATE, #1<br/> 8. SOURCE, #1</p>                            | <p><b>STYLE 4:</b><br/> PIN 1. ANODE<br/> 2. ANODE<br/> 3. ANODE<br/> 4. ANODE<br/> 5. ANODE<br/> 6. ANODE<br/> 7. ANODE<br/> 8. COMMON CATHODE</p>   |
| <p><b>STYLE 5:</b><br/> PIN 1. DRAIN<br/> 2. DRAIN<br/> 3. DRAIN<br/> 4. DRAIN<br/> 5. GATE<br/> 6. GATE<br/> 7. SOURCE<br/> 8. SOURCE</p>   | <p><b>STYLE 6:</b><br/> PIN 1. SOURCE<br/> 2. DRAIN<br/> 3. DRAIN<br/> 4. SOURCE<br/> 5. SOURCE<br/> 6. GATE<br/> 7. GATE<br/> 8. SOURCE</p>  | <p><b>STYLE 7:</b><br/> PIN 1. INPUT<br/> 2. EXTERNAL BYPASS<br/> 3. THIRD STAGE SOURCE<br/> 4. GROUND<br/> 5. DRAIN<br/> 6. GATE 3<br/> 7. SECOND STAGE Vd<br/> 8. FIRST STAGE Vd</p>                    | <p><b>STYLE 8:</b><br/> PIN 1. COLLECTOR, DIE #1<br/> 2. BASE, #1<br/> 3. BASE, #2<br/> 4. COLLECTOR, #2<br/> 5. COLLECTOR, #2<br/> 6. EMITTER, #2<br/> 7. EMITTER, #1<br/> 8. COLLECTOR, #1</p>                              |
| <p><b>STYLE 9:</b><br/> PIN 1. EMITTER, COMMON<br/> 2. COLLECTOR, DIE #1<br/> 3. COLLECTOR, DIE #2<br/> 4. EMITTER, COMMON<br/> 5. EMITTER, COMMON<br/> 6. BASE, DIE #2<br/> 7. BASE, DIE #1<br/> 8. EMITTER, COMMON</p> | <p><b>STYLE 10:</b><br/> PIN 1. GROUND<br/> 2. BIAS 1<br/> 3. OUTPUT<br/> 4. GROUND<br/> 5. GROUND<br/> 6. BIAS 2<br/> 7. INPUT<br/> 8. GROUND</p>  | <p><b>STYLE 11:</b><br/> PIN 1. SOURCE 1<br/> 2. GATE 1<br/> 3. SOURCE 2<br/> 4. GATE 2<br/> 5. DRAIN 2<br/> 6. DRAIN 2<br/> 7. DRAIN 1<br/> 8. DRAIN 1</p>   | <p><b>STYLE 12:</b><br/> PIN 1. SOURCE<br/> 2. SOURCE<br/> 3. SOURCE<br/> 4. GATE<br/> 5. DRAIN<br/> 6. DRAIN<br/> 7. DRAIN<br/> 8. DRAIN</p>   |
| <p><b>STYLE 13:</b><br/> PIN 1. N.C.<br/> 2. SOURCE<br/> 3. SOURCE<br/> 4. GATE<br/> 5. DRAIN<br/> 6. DRAIN<br/> 7. DRAIN<br/> 8. DRAIN</p>  | <p><b>STYLE 14:</b><br/> PIN 1. N-SOURCE<br/> 2. N-GATE<br/> 3. P-SOURCE<br/> 4. P-GATE<br/> 5. P-DRAIN<br/> 6. P-DRAIN<br/> 7. N-DRAIN<br/> 8. N-DRAIN</p>   | <p><b>STYLE 15:</b><br/> PIN 1. ANODE 1<br/> 2. ANODE 1<br/> 3. ANODE 1<br/> 4. ANODE 1<br/> 5. CATHODE, COMMON<br/> 6. CATHODE, COMMON<br/> 7. CATHODE, COMMON<br/> 8. CATHODE, COMMON</p>               | <p><b>STYLE 16:</b><br/> PIN 1. EMITTER, DIE #1<br/> 2. BASE, DIE #1<br/> 3. EMITTER, DIE #2<br/> 4. BASE, DIE #2<br/> 5. COLLECTOR, DIE #2<br/> 6. COLLECTOR, DIE #2<br/> 7. COLLECTOR, DIE #1<br/> 8. COLLECTOR, DIE #1</p> |
| <p><b>STYLE 17:</b><br/> PIN 1. VCC<br/> 2. V2OUT<br/> 3. V1OUT<br/> 4. TXE<br/> 5. RXE<br/> 6. VEE<br/> 7. GND<br/> 8. ACC</p>  | <p><b>STYLE 18:</b><br/> PIN 1. ANODE<br/> 2. ANODE<br/> 3. SOURCE<br/> 4. GATE<br/> 5. DRAIN<br/> 6. DRAIN<br/> 7. CATHODE<br/> 8. CATHODE</p>   | <p><b>STYLE 19:</b><br/> PIN 1. SOURCE 1<br/> 2. GATE 1<br/> 3. SOURCE 2<br/> 4. GATE 2<br/> 5. DRAIN 2<br/> 6. MIRROR 2<br/> 7. DRAIN 1<br/> 8. MIRROR 1</p>   | <p><b>STYLE 20:</b><br/> PIN 1. SOURCE (N)<br/> 2. GATE (N)<br/> 3. SOURCE (P)<br/> 4. GATE (P)<br/> 5. DRAIN<br/> 6. DRAIN<br/> 7. DRAIN<br/> 8. DRAIN</p>   |
| <p><b>STYLE 21:</b><br/> PIN 1. CATHODE 1<br/> 2. CATHODE 2<br/> 3. CATHODE 3<br/> 4. CATHODE 4<br/> 5. CATHODE 5<br/> 6. COMMON ANODE<br/> 7. COMMON ANODE<br/> 8. CATHODE 6</p>  | <p><b>STYLE 22:</b><br/> PIN 1. I/O LINE 1<br/> 2. COMMON CATHODE/VCC<br/> 3. COMMON CATHODE/VCC<br/> 4. I/O LINE 3<br/> 5. COMMON ANODE/GND<br/> 6. I/O LINE 4<br/> 7. I/O LINE 5<br/> 8. COMMON ANODE/GND</p> | <p><b>STYLE 23:</b><br/> PIN 1. LINE 1 IN<br/> 2. COMMON ANODE/GND<br/> 3. COMMON ANODE/GND<br/> 4. LINE 2 IN<br/> 5. LINE 2 OUT<br/> 6. COMMON ANODE/GND<br/> 7. COMMON ANODE/GND<br/> 8. LINE 1 OUT</p> | <p><b>STYLE 24:</b><br/> PIN 1. BASE<br/> 2. EMITTER<br/> 3. COLLECTOR/ANODE<br/> 4. COLLECTOR/ANODE<br/> 5. CATHODE<br/> 6. CATHODE<br/> 7. COLLECTOR/ANODE<br/> 8. COLLECTOR/ANODE</p>                                      |
| <p><b>STYLE 25:</b><br/> PIN 1. VIN<br/> 2. N/C<br/> 3. REXT<br/> 4. GND<br/> 5. IOUT<br/> 6. IOUT<br/> 7. IOUT<br/> 8. IOUT</p>   | <p><b>STYLE 26:</b><br/> PIN 1. GND<br/> 2. dv/dt<br/> 3. ENABLE<br/> 4. ILIMIT<br/> 5. SOURCE<br/> 6. SOURCE<br/> 7. SOURCE<br/> 8. VCC</p>  | <p><b>STYLE 27:</b><br/> PIN 1. ILIMIT<br/> 2. OVLO<br/> 3. UVLO<br/> 4. INPUT+<br/> 5. SOURCE<br/> 6. SOURCE<br/> 7. SOURCE<br/> 8. DRAIN</p>  | <p><b>STYLE 28:</b><br/> PIN 1. SW_TO_GND<br/> 2. DASIC OFF<br/> 3. DASIC_SW_DET<br/> 4. GND<br/> 5. V_MON<br/> 6. VBULK<br/> 7. VBULK<br/> 8. VIN</p>  |
| <p><b>STYLE 29:</b><br/> PIN 1. BASE, DIE #1<br/> 2. EMITTER, #1<br/> 3. BASE, #2<br/> 4. EMITTER, #2<br/> 5. COLLECTOR, #2<br/> 6. COLLECTOR, #2<br/> 7. COLLECTOR, #1<br/> 8. COLLECTOR, #1</p>                        | <p><b>STYLE 30:</b><br/> PIN 1. DRAIN 1<br/> 2. DRAIN 1<br/> 3. GATE 2<br/> 4. SOURCE 2<br/> 5. SOURCE 1/DRAIN 2<br/> 6. SOURCE 1/DRAIN 2<br/> 7. SOURCE 1/DRAIN 2<br/> 8. GATE 1</p>                           |   |   |

<b>DOCUMENT NUMBER:</b>	<b>98ASB42564B</b>	Electronic versions are uncontrolled except when accessed directly from the Document Repository. Printed versions are uncontrolled except when stamped "CONTROLLED COPY" in red.
<b>DESCRIPTION:</b>	<b>SOIC-8 NB</b>	<b>PAGE 2 OF 2</b>

ON Semiconductor and  are trademarks of Semiconductor Components Industries, LLC dba ON Semiconductor or its subsidiaries in the United States and/or other countries. ON Semiconductor reserves the right to make changes without further notice to any products herein. ON Semiconductor makes no warranty, representation or guarantee regarding the suitability of its products for any particular purpose, nor does ON Semiconductor assume any liability arising out of the application or use of any product or circuit, and specifically disclaims any and all liability, including without limitation special, consequential or incidental damages. ON Semiconductor does not convey any license under its patent rights nor the rights of others.

# MECHANICAL CASE OUTLINE PACKAGE DIMENSIONS

ON Semiconductor®

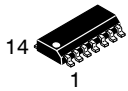

SCALE 1:1

SOIC-14 NB  
CASE 751A-03  
ISSUE L

DATE 03 FEB 2016

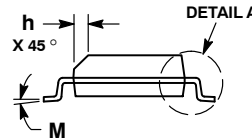
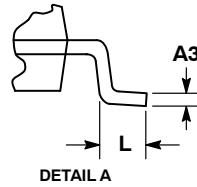
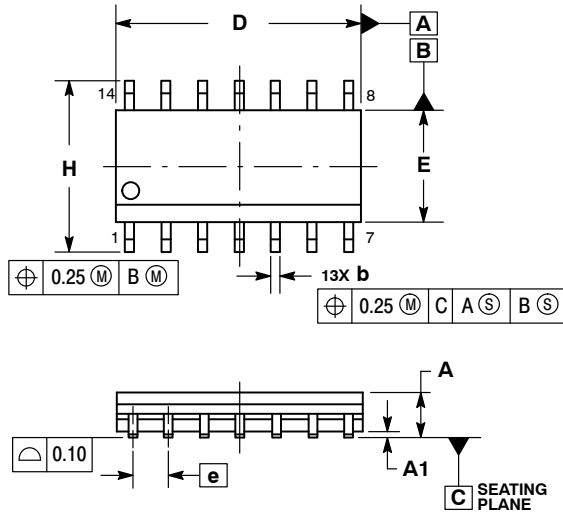

- NOTES:
1. DIMENSIONING AND TOLERANCING PER ASME Y14.5M, 1994.
  2. CONTROLLING DIMENSION: MILLIMETERS.
  3. DIMENSION b DOES NOT INCLUDE DAMBAR PROTRUSION. ALLOWABLE PROTRUSION SHALL BE 0.13 TOTAL IN EXCESS OF AT MAXIMUM MATERIAL CONDITION.
  4. DIMENSIONS D AND E DO NOT INCLUDE MOLD PROTRUSIONS.
  5. MAXIMUM MOLD PROTRUSION 0.15 PER SIDE.

DIM	MILLIMETERS		INCHES	
	MIN	MAX	MIN	MAX
A	1.35	1.75	0.054	0.068
A1	0.10	0.25	0.004	0.010
A3	0.19	0.25	0.008	0.010
b	0.35	0.49	0.014	0.019
D	8.55	8.75	0.337	0.344
E	3.80	4.00	0.150	0.157
e	1.27 BSC		0.050 BSC	
H	5.80	6.20	0.228	0.244
h	0.25	0.50	0.010	0.019
L	0.40	1.25	0.016	0.049
M	0°	7°	0°	7°

### SOLDERING FOOTPRINT\*



DIMENSIONS: MILLIMETERS

\*For additional information on our Pb-Free strategy and soldering details, please download the ON Semiconductor Soldering and Mounting Techniques Reference Manual, SOLDERRM/D.

### GENERIC MARKING DIAGRAM\*



- XXXXXX = Specific Device Code
- A = Assembly Location
- WL = Wafer Lot
- Y = Year
- WW = Work Week
- G = Pb-Free Package

\*This information is generic. Please refer to device data sheet for actual part marking. Pb-Free indicator, "G" or microdot "▪", may or may not be present.

## STYLES ON PAGE 2

DOCUMENT NUMBER:	98ASB42565B	Electronic versions are uncontrolled except when accessed directly from the Document Repository. Printed versions are uncontrolled except when stamped "CONTROLLED COPY" in red.
DESCRIPTION:	SOIC-14 NB	PAGE 1 OF 2

ON Semiconductor and ON are trademarks of Semiconductor Components Industries, LLC dba ON Semiconductor or its subsidiaries in the United States and/or other countries. ON Semiconductor reserves the right to make changes without further notice to any products herein. ON Semiconductor makes no warranty, representation or guarantee regarding the suitability of its products for any particular purpose, nor does ON Semiconductor assume any liability arising out of the application or use of any product or circuit, and specifically disclaims any and all liability, including without limitation special, consequential or incidental damages. ON Semiconductor does not convey any license under its patent rights nor the rights of others.

**SOIC-14**  
**CASE 751A-03**  
**ISSUE L**

DATE 03 FEB 2016

STYLE 1:  
 PIN 1. COMMON CATHODE  
 2. ANODE/CATHODE  
 3. ANODE/CATHODE  
 4. NO CONNECTION  
 5. ANODE/CATHODE  
 6. NO CONNECTION  
 7. ANODE/CATHODE  
 8. ANODE/CATHODE  
 9. ANODE/CATHODE  
 10. NO CONNECTION  
 11. ANODE/CATHODE  
 12. ANODE/CATHODE  
 13. NO CONNECTION  
 14. COMMON ANODE

STYLE 2:  
 CANCELLED

STYLE 3:  
 PIN 1. NO CONNECTION  
 2. ANODE  
 3. ANODE  
 4. NO CONNECTION  
 5. ANODE  
 6. NO CONNECTION  
 7. ANODE  
 8. ANODE  
 9. ANODE  
 10. NO CONNECTION  
 11. ANODE  
 12. ANODE  
 13. NO CONNECTION  
 14. COMMON CATHODE

STYLE 4:  
 PIN 1. NO CONNECTION  
 2. CATHODE  
 3. CATHODE  
 4. NO CONNECTION  
 5. CATHODE  
 6. NO CONNECTION  
 7. CATHODE  
 8. CATHODE  
 9. CATHODE  
 10. NO CONNECTION  
 11. CATHODE  
 12. CATHODE  
 13. NO CONNECTION  
 14. COMMON ANODE

STYLE 5:  
 PIN 1. COMMON CATHODE  
 2. ANODE/CATHODE  
 3. ANODE/CATHODE  
 4. ANODE/CATHODE  
 5. ANODE/CATHODE  
 6. NO CONNECTION  
 7. COMMON ANODE  
 8. COMMON CATHODE  
 9. ANODE/CATHODE  
 10. ANODE/CATHODE  
 11. ANODE/CATHODE  
 12. ANODE/CATHODE  
 13. NO CONNECTION  
 14. COMMON ANODE

STYLE 6:  
 PIN 1. CATHODE  
 2. CATHODE  
 3. CATHODE  
 4. CATHODE  
 5. CATHODE  
 6. CATHODE  
 7. CATHODE  
 8. ANODE  
 9. ANODE  
 10. ANODE  
 11. ANODE  
 12. ANODE  
 13. ANODE  
 14. ANODE

STYLE 7:  
 PIN 1. ANODE/CATHODE  
 2. COMMON ANODE  
 3. COMMON CATHODE  
 4. ANODE/CATHODE  
 5. ANODE/CATHODE  
 6. ANODE/CATHODE  
 7. ANODE/CATHODE  
 8. ANODE/CATHODE  
 9. ANODE/CATHODE  
 10. ANODE/CATHODE  
 11. COMMON CATHODE  
 12. COMMON ANODE  
 13. ANODE/CATHODE  
 14. ANODE/CATHODE

STYLE 8:  
 PIN 1. COMMON CATHODE  
 2. ANODE/CATHODE  
 3. ANODE/CATHODE  
 4. NO CONNECTION  
 5. ANODE/CATHODE  
 6. ANODE/CATHODE  
 7. COMMON ANODE  
 8. COMMON ANODE  
 9. ANODE/CATHODE  
 10. ANODE/CATHODE  
 11. NO CONNECTION  
 12. ANODE/CATHODE  
 13. ANODE/CATHODE  
 14. COMMON CATHODE

<b>DOCUMENT NUMBER:</b>	<b>98ASB42565B</b>	Electronic versions are uncontrolled except when accessed directly from the Document Repository. Printed versions are uncontrolled except when stamped "CONTROLLED COPY" in red.
<b>DESCRIPTION:</b>	<b>SOIC-14 NB</b>	<b>PAGE 2 OF 2</b>

ON Semiconductor and  are trademarks of Semiconductor Components Industries, LLC dba ON Semiconductor or its subsidiaries in the United States and/or other countries. ON Semiconductor reserves the right to make changes without further notice to any products herein. ON Semiconductor makes no warranty, representation or guarantee regarding the suitability of its products for any particular purpose, nor does ON Semiconductor assume any liability arising out of the application or use of any product or circuit, and specifically disclaims any and all liability, including without limitation special, consequential or incidental damages. ON Semiconductor does not convey any license under its patent rights nor the rights of others.

# MECHANICAL CASE OUTLINE

## PACKAGE DIMENSIONS

ON Semiconductor®



SCALE 2:1

### Micro8 CASE 846A-02 ISSUE K

DATE 16 JUL 2020



TOP VIEW

NOTE 3



SIDE VIEW

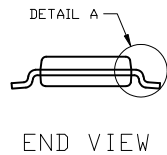

END VIEW

**NOTES:**

1. DIMENSIONING AND TOLERANCING PER ASME Y14.5M, 2009.
2. CONTROLLING DIMENSION: MILLIMETERS
3. DIMENSION *b* DOES NOT INCLUDE DAMBAR PROTRUSION. ALLOWABLE PROTRUSION SHALL BE 0.10 mm IN EXCESS OF MAXIMUM MATERIAL CONDITION.
4. DIMENSIONS *D* AND *E* DO NOT INCLUDE MOLD FLASH, PROTRUSION OR GATE BURRS. MOLD FLASH, PROTRUSIONS, OR GATE BURRS SHALL NOT EXCEED 0.15 mm PER SIDE. DIMENSION *E* DOES NOT INCLUDE INTERLEAD FLASH OR PROTRUSION. INTERLEAD FLASH OR PROTRUSION SHALL NOT EXCEED 0.25 mm PER SIDE. DIMENSIONS *D* AND *E* ARE DETERMINED AT DATUM *F*.
5. DATUMS *A* AND *B* ARE TO BE DETERMINED AT DATUM *F*.
6. *A1* IS DEFINED AS THE VERTICAL DISTANCE FROM THE SEATING PLANE TO THE LOWEST POINT ON THE PACKAGE BODY.

⌀ 0.08 (0.003) M C B S A S

DIM	MILLIMETERS		
	MIN.	NOM.	MAX.
A	---	---	1.10
A1	0.05	0.08	0.15
<i>b</i>	0.25	0.33	0.40
<i>c</i>	0.13	0.18	0.23
<i>D</i>	2.90	3.00	3.10
<i>E</i>	2.90	3.00	3.10
<i>e</i>	0.65 BSC		
<i>H<sub>E</sub></i>	4.75	4.90	5.05
<i>L</i>	0.40	0.55	0.70

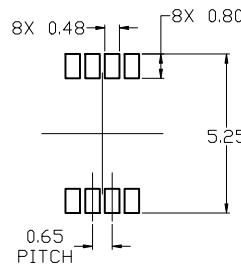

RECOMMENDED MOUNTING FOOTPRINT

For additional information on our Pb-Free strategy and soldering details, please download the ON Semiconductor Soldering and Mounting Techniques Reference Manual, SOLDERM/D.

### GENERIC MARKING DIAGRAM\*

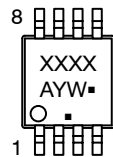

- XXXX = Specific Device Code
- A = Assembly Location
- Y = Year
- W = Work Week
- = Pb-Free Package

(Note: Microdot may be in either location)

\*This information is generic. Please refer to device data sheet for actual part marking. Pb-Free indicator, "G" or microdot "▪", may or may not be present. Some products may not follow the Generic Marking.

**STYLE 1:**

1. SOURCE
2. SOURCE
3. SOURCE
4. GATE
5. DRAIN
6. DRAIN
7. DRAIN
8. DRAIN

**STYLE 2:**

1. SOURCE 1
2. GATE 1
3. SOURCE 2
4. GATE 2
5. DRAIN 2
6. DRAIN 2
7. DRAIN 1
8. DRAIN 1

**STYLE 3:**

1. N-SOURCE
2. N-GATE
3. P-SOURCE
4. P-GATE
5. P-DRAIN
6. P-DRAIN
7. N-DRAIN
8. N-DRAIN

<b>DOCUMENT NUMBER:</b>	<b>98ASB14087C</b>	Electronic versions are uncontrolled except when accessed directly from the Document Repository. Printed versions are uncontrolled except when stamped "CONTROLLED COPY" in red.
<b>DESCRIPTION:</b>	<b>MICRO8</b>	<b>PAGE 1 OF 1</b>

ON Semiconductor and ON are trademarks of Semiconductor Components Industries, LLC dba ON Semiconductor or its subsidiaries in the United States and/or other countries. ON Semiconductor reserves the right to make changes without further notice to any products herein. ON Semiconductor makes no warranty, representation or guarantee regarding the suitability of its products for any particular purpose, nor does ON Semiconductor assume any liability arising out of the application or use of any product or circuit, and specifically disclaims any and all liability, including without limitation special, consequential or incidental damages. ON Semiconductor does not convey any license under its patent rights nor the rights of others.

# MECHANICAL CASE OUTLINE PACKAGE DIMENSIONS

ON Semiconductor®

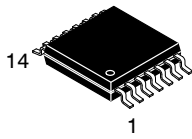

**TSSOP-14 WB**  
CASE 948G  
ISSUE C

DATE 17 FEB 2016

SCALE 2:1

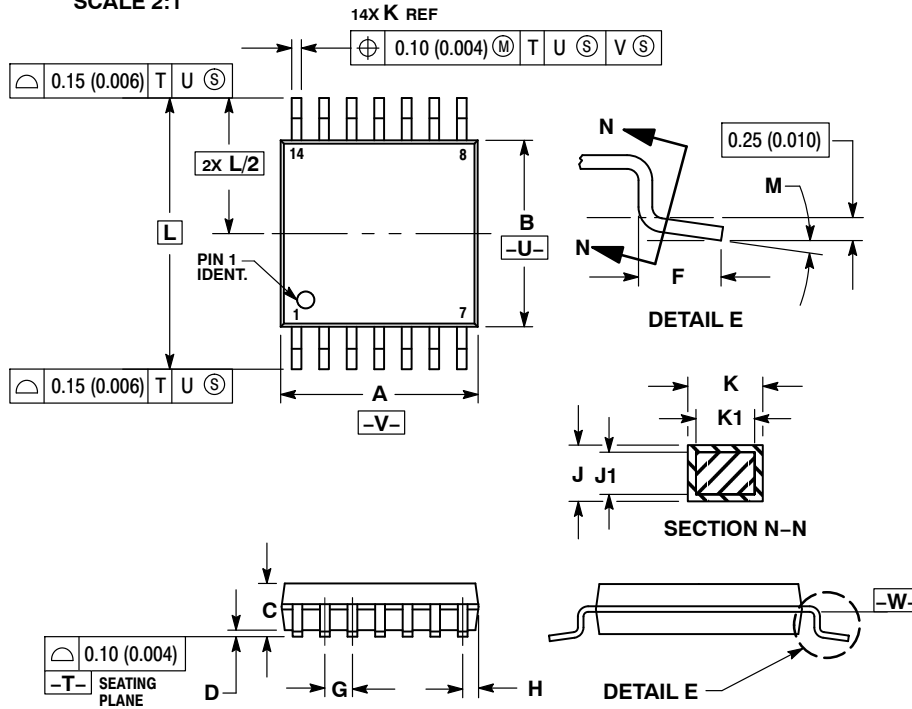

**NOTES:**

- DIMENSIONING AND TOLERANCING PER ANSI Y14.5M, 1982.
- CONTROLLING DIMENSION: MILLIMETER.
- DIMENSION A DOES NOT INCLUDE MOLD FLASH, PROTRUSIONS OR GATE BURRS. MOLD FLASH OR GATE BURRS SHALL NOT EXCEED 0.15 (0.006) PER SIDE.
- DIMENSION B DOES NOT INCLUDE INTERLEAD FLASH OR PROTRUSION. INTERLEAD FLASH OR PROTRUSION SHALL NOT EXCEED 0.25 (0.010) PER SIDE.
- DIMENSION K DOES NOT INCLUDE DAMBAR PROTRUSION. ALLOWABLE DAMBAR PROTRUSION SHALL BE 0.08 (0.003) TOTAL IN EXCESS OF THE K DIMENSION AT MAXIMUM MATERIAL CONDITION.
- TERMINAL NUMBERS ARE SHOWN FOR REFERENCE ONLY.
- DIMENSION A AND B ARE TO BE DETERMINED AT DATUM PLANE -W-.

DIM	MILLIMETERS		INCHES	
	MIN	MAX	MIN	MAX
A	4.90	5.10	0.193	0.200
B	4.30	4.50	0.169	0.177
C	---	1.20	---	0.047
D	0.05	0.15	0.002	0.006
F	0.50	0.75	0.020	0.030
G	0.65 BSC		0.026 BSC	
H	0.50	0.60	0.020	0.024
J	0.09	0.20	0.004	0.008
J1	0.09	0.16	0.004	0.006
K	0.19	0.30	0.007	0.012
K1	0.19	0.25	0.007	0.010
L	6.40 BSC		0.252 BSC	
M	0°	8°	0°	8°

**GENERIC MARKING DIAGRAM\***

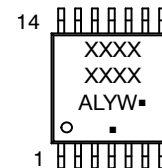

- A = Assembly Location
- L = Wafer Lot
- Y = Year
- W = Work Week
- = Pb-Free Package

(Note: Microdot may be in either location)

\*This information is generic. Please refer to device data sheet for actual part marking. Pb-Free indicator, "G" or microdot "▪", may or may not be present.

**SOLDERING FOOTPRINT**

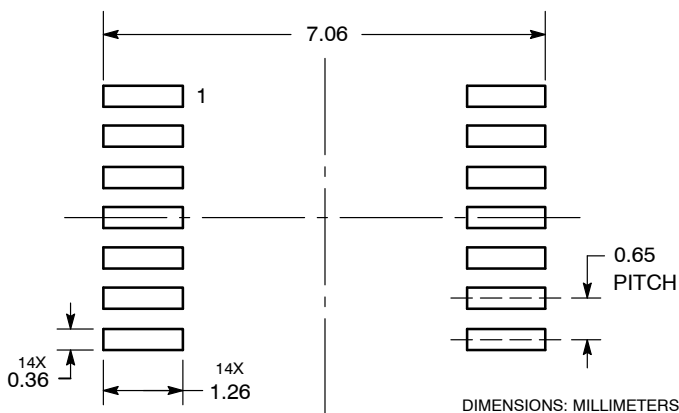

<b>DOCUMENT NUMBER:</b>	<b>98ASH70246A</b>	Electronic versions are uncontrolled except when accessed directly from the Document Repository. Printed versions are uncontrolled except when stamped "CONTROLLED COPY" in red.
<b>DESCRIPTION:</b>	<b>TSSOP-14 WB</b>	<b>PAGE 1 OF 1</b>

ON Semiconductor and ON are trademarks of Semiconductor Components Industries, LLC dba ON Semiconductor or its subsidiaries in the United States and/or other countries. ON Semiconductor reserves the right to make changes without further notice to any products herein. ON Semiconductor makes no warranty, representation or guarantee regarding the suitability of its products for any particular purpose, nor does ON Semiconductor assume any liability arising out of the application or use of any product or circuit, and specifically disclaims any and all liability, including without limitation special, consequential or incidental damages. ON Semiconductor does not convey any license under its patent rights nor the rights of others.

ON Semiconductor and  are trademarks of Semiconductor Components Industries, LLC dba ON Semiconductor or its subsidiaries in the United States and/or other countries. ON Semiconductor owns the rights to a number of patents, trademarks, copyrights, trade secrets, and other intellectual property. A listing of ON Semiconductor's product/patent coverage may be accessed at [www.onsemi.com/site/pdf/Patent-Marking.pdf](http://www.onsemi.com/site/pdf/Patent-Marking.pdf). ON Semiconductor reserves the right to make changes without further notice to any products herein. ON Semiconductor makes no warranty, representation or guarantee regarding the suitability of its products for any particular purpose, nor does ON Semiconductor assume any liability arising out of the application or use of any product or circuit, and specifically disclaims any and all liability, including without limitation special, consequential or incidental damages. Buyer is responsible for its products and applications using ON Semiconductor products, including compliance with all laws, regulations and safety requirements or standards, regardless of any support or applications information provided by ON Semiconductor. "Typical" parameters which may be provided in ON Semiconductor data sheets and/or specifications can and do vary in different applications and actual performance may vary over time. All operating parameters, including "Typicals" must be validated for each customer application by customer's technical experts. ON Semiconductor does not convey any license under its patent rights nor the rights of others. ON Semiconductor products are not designed, intended, or authorized for use as a critical component in life support systems or any FDA Class 3 medical devices or medical devices with a same or similar classification in a foreign jurisdiction or any devices intended for implantation in the human body. Should Buyer purchase or use ON Semiconductor products for any such unintended or unauthorized application, Buyer shall indemnify and hold ON Semiconductor and its officers, employees, subsidiaries, affiliates, and distributors harmless against all claims, costs, damages, and expenses, and reasonable attorney fees arising out of, directly or indirectly, any claim of personal injury or death associated with such unintended or unauthorized use, even if such claim alleges that ON Semiconductor was negligent regarding the design or manufacture of the part. ON Semiconductor is an Equal Opportunity/Affirmative Action Employer. This literature is subject to all applicable copyright laws and is not for resale in any manner.

## PUBLICATION ORDERING INFORMATION

### LITERATURE FULFILLMENT:

Email Requests to: [orderlit@onsemi.com](mailto:orderlit@onsemi.com)

ON Semiconductor Website: [www.onsemi.com](http://www.onsemi.com)

### TECHNICAL SUPPORT

North American Technical Support:  
Voice Mail: 1 800-282-9855 Toll Free USA/Canada  
Phone: 011 421 33 790 2910

Europe, Middle East and Africa Technical Support:

Phone: 00421 33 790 2910

For additional information, please contact your local Sales Representative