

NCP716

80 mA Ultra-Low Iq, Wide Input Voltage Low Dropout Regulator

The NCP716 is 80 mA LDO Linear Voltage Regulator. It is a very stable and accurate device with ultra-low ground current consumption (4.7 μA over the full output load range) and a wide input voltage range (up to 24 V). The regulator incorporates several protection features such as Thermal Shutdown and Current Limiting.

Features

- Operating Input Voltage Range: 2.5 V to 24 V
- Fixed Voltage Options Available: 1.2 V to 5.0 V
- Ultra Low Quiescent Current: Max. 4.7 μA over Temperature
- $\pm 2\%$ Accuracy over Full Load, Line and Temperature Variations
- PSRR: 60 dB at 100 kHz
- Noise: 200 μV_{RMS} from 200 Hz to 100 kHz
- Thermal Shutdown and Current Limit Protection
- Available in WDFN6, 2x2x0.8 mm Package
- This is a Pb-Free Device

Typical Applications

- Portable Equipment
- Communication Systems

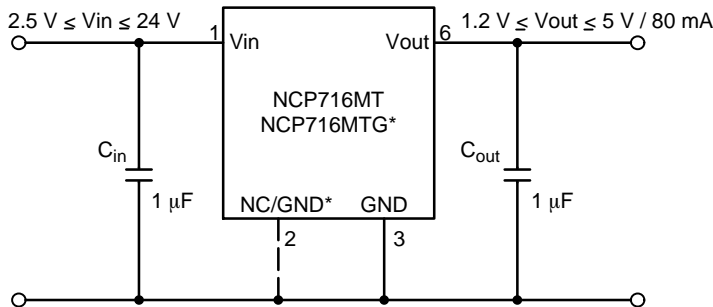

Figure 1. Typical Application Schematic



ON Semiconductor®

www.onsemi.com

MARKING DIAGRAMS

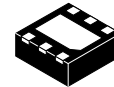

WDFN6
CASE 511BR

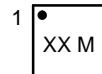

XX = Specific Device Code
M = Date Code

PIN CONNECTIONS

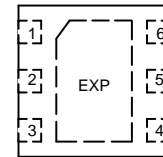

WDFN6 2x2 mm
(Top View)

ORDERING INFORMATION

See detailed ordering and shipping information in the package dimensions section on page 17 of this data sheet.

NCP716



Figure 2. Simplified Block Diagram

Table 1. PIN FUNCTION DESCRIPTION

Pin No. wDFN6, 2 x 2	Pin Name	Description
6	OUT	Regulated output voltage pin. A small 0.47 μ F ceramic capacitor is needed from this pin to ground to assure stability.
2	NC/GND*	No connection at NCP716MT devices. This pin can be tied to ground to improve thermal dissipation or left disconnected. *Power supply ground at NCP716MTG devices.
3, EXP	GND	Power supply ground. Exposed pad EXP must be tied with GND pin 3.
4	N/C	No connection. This pin can be tied to ground to improve thermal dissipation or left disconnected.
5	N/C	No connection. This pin can be tied to ground to improve thermal dissipation or left disconnected.
1	IN	Input pin. A small capacitor is needed from this pin to ground to assure stability.

Table 2. ABSOLUTE MAXIMUM RATINGS

Rating	Symbol	Value	Unit
Input Voltage (Note 1)	V_{IN}	-0.3 to 24	V
Output Voltage	V_{OUT}	-0.3 to 6	V
Output Short Circuit Duration	t_{SC}	Indefinite	s
Maximum Junction Temperature	$T_{J(MAX)}$	150	$^{\circ}$ C
Operating Ambient Temperature Range	T_A	-40 to 125	$^{\circ}$ C
Storage Temperature Range	T_{STG}	-55 to 150	$^{\circ}$ C
ESD Capability, Human Body Model (Note 2)	ESD_{HBM}	2000	V
ESD Capability, Machine Model (Note 2)	ESD_{MM}	200	V

Stresses exceeding those listed in the Maximum Ratings table may damage the device. If any of these limits are exceeded, device functionality should not be assumed, damage may occur and reliability may be affected.

1. Refer to ELECTRICAL CHARACTERISTICS and APPLICATION INFORMATION for Safe Operating Area.
2. This device series incorporates ESD protection and is tested by the following methods:
 ESD Human Body Model tested per EIA/JESD22-A114
 ESD Machine Model tested per EIA/JESD22-A115
 ESD Charged Device Model tested per EIA/JESD22-C101E
 Latch up Current Maximum Rating tested per JEDEC standard: JESD78.

Table 3. THERMAL CHARACTERISTICS

Rating	Symbol	Value	Unit
Thermal Characteristics, WDFN6, 2 mm x 2 mm Thermal Resistance, Junction-to-Air	$R_{\theta JA}$	120	$^{\circ}$ C/W

NCP716

Table 4. ELECTRICAL CHARACTERISTICS Voltage version 1.2 V

$-40^{\circ}\text{C} \leq T_J \leq 125^{\circ}\text{C}$; $V_{IN} = 3.0\text{ V}$; $I_{OUT} = 1\text{ mA}$, $C_{IN} = C_{OUT} = 1.0\text{ }\mu\text{F}$, unless otherwise noted. Typical values are at $T_J = +25^{\circ}\text{C}$. (Note 5)

Parameter	Test Conditions	Symbol	Min	Typ	Max	Unit
Operating Input Voltage	$I_{OUT} \leq 10\text{ mA}$	V_{IN}	2.5		24	V
	$10\text{ mA} < I_{OUT} < 80\text{ mA}$		3.0		24	
Output Voltage Accuracy	$3.0\text{ V} < V_{IN} < 24\text{ V}$, $0 < I_{OUT} < 80\text{ mA}$	V_{OUT}	1.164	1.2	1.236	V
Turn-On Time	$I_{OUT} = 1\text{ mA}$	t_{ON}	–	700	–	μs
Undervoltage Lock-Out	V_{IN} rising	UVLO	–	2.1	–	V
Line Regulation	$3.0\text{ V} \leq V_{IN} \leq 24\text{ V}$, $I_{OUT} = 1\text{ mA}$	Reg _{LINE}		30		mV
Load Regulation	$I_{OUT} = 0\text{ mA}$ to 80 mA	Reg _{LOAD}		20		mV
Dropout voltage (Note 3)		V_{DO}			–	mV
Maximum Output Current	(Note 6)	I_{OUT}	110			mA
Ground current	$0 < I_{OUT} < 80\text{ mA}$, $-40 < T_A < 85^{\circ}\text{C}$	I_{GND}		3.2	4.2	μA
	$0 < I_{OUT} < 80\text{ mA}$, $V_{IN} = 24\text{ V}$				5.8	
Power Supply Rejection Ratio	$V_{IN} = 3.0\text{ V}$, $V_{OUT} = 1.2\text{ V}$ $V_{PP} = 200\text{ mV}$ modulation $I_{OUT} = 1\text{ mA}$, $C_{OUT} = 10\text{ }\mu\text{F}$	$f = 100\text{ kHz}$		63		dB
Output Noise Voltage	$V_{OUT} = 1.2\text{ V}$, $I_{OUT} = 80\text{ mA}$ $f = 200\text{ Hz}$ to 100 kHz	V_N		105		μV_{rms}
Thermal Shutdown Temperature (Note 4)	Temperature increasing from $T_J = +25^{\circ}\text{C}$	T_{SD}		155		$^{\circ}\text{C}$
Thermal Shutdown Hysteresis (Note 4)	Temperature falling from T_{SD}	T_{SDH}	–	25	–	$^{\circ}\text{C}$

3. Not Characterized at $V_{IN} = 3.0\text{ V}$, $V_{OUT} = 1.2\text{ V}$, $I_{OUT} = 80\text{ mA}$

4. Guaranteed by design and characterization.

5. Performance guaranteed over the indicated operating temperature range by design and/or characterization production tested at $T_J = T_A = 25^{\circ}\text{C}$. Low duty cycle pulse techniques are used during testing to maintain the junction temperature as close to ambient as possible.

6. Respect SOA

NCP716

Table 5. ELECTRICAL CHARACTERISTICS Voltage version 1.5 V

$-40^{\circ}\text{C} \leq T_J \leq 125^{\circ}\text{C}$; $V_{IN} = 3.0\text{ V}$; $I_{OUT} = 1\text{ mA}$, $C_{IN} = C_{OUT} = 1.0\text{ }\mu\text{F}$, unless otherwise noted. Typical values are at $T_J = +25^{\circ}\text{C}$. (Note 9)

Parameter	Test Conditions	Symbol	Min	Typ	Max	Unit
Operating Input Voltage	$I_{OUT} \leq 10\text{ mA}$	V_{IN}	2.5		24	V
	$10\text{ mA} < I_{OUT} < 80\text{ mA}$		3.0		24	
Output Voltage Accuracy	$3.0\text{ V} < V_{IN} < 24\text{ V}$, $0 < I_{OUT} < 80\text{ mA}$	V_{OUT}	1.455	1.5	1.545	V
Turn-On Time	$I_{OUT} = 1\text{ mA}$	t_{ON}	–	700	–	μs
Undervoltage Lock-Out	V_{IN} rising	UVLO	–	2.1	–	V
Line Regulation	$3.0\text{ V} \leq V_{IN} \leq 24\text{ V}$, $I_{OUT} = 1\text{ mA}$	Reg _{LINE}		20		mV
Load Regulation	$I_{OUT} = 0\text{ mA}$ to 80 mA	Reg _{LOAD}		20		mV
Dropout voltage (Note 7)						
Maximum Output Current	(Note 10)	I_{OUT}	110			mA
Ground current	$0 < I_{OUT} < 80\text{ mA}$, $-40 < T_A < 85^{\circ}\text{C}$	I_{GND}		3.2	4.2	μA
	$0 < I_{OUT} < 80\text{ mA}$, $V_{IN} = 24\text{ V}$				5.8	μA
Power Supply Rejection Ratio	$V_{IN} = 3.0\text{ V}$, $V_{OUT} = 1.5\text{ V}$ $V_{PP} = 200\text{ mV}$ modulation $I_{OUT} = 1\text{ mA}$, $C_{OUT} = 10\text{ }\mu\text{F}$	$f = 100\text{ kHz}$	PSRR		60	dB
Output Noise Voltage	$V_{OUT} = 1.5\text{ V}$, $I_{OUT} = 80\text{ mA}$ $f = 200\text{ Hz}$ to 100 kHz	V_N		120		μV_{rms}
Thermal Shutdown Temperature (Note 8)	Temperature increasing from $T_J = +25^{\circ}\text{C}$	T_{SD}		155		$^{\circ}\text{C}$
Thermal Shutdown Hysteresis (Note 8)	Temperature falling from T_{SD}	T_{SDH}	–	25	–	$^{\circ}\text{C}$

7. Not Characterized at $V_{IN} = 3.0\text{ V}$, $V_{OUT} = 1.5\text{ V}$, $I_{OUT} = 80\text{ mA}$

8. Guaranteed by design and characterization.

9. Performance guaranteed over the indicated operating temperature range by design and/or characterization production tested at $T_J = T_A = 25^{\circ}\text{C}$. Low duty cycle pulse techniques are used during testing to maintain the junction temperature as close to ambient as possible.

10. Respect SOA

NCP716

Table 6. ELECTRICAL CHARACTERISTICS Voltage version 1.8 V

$-40^{\circ}\text{C} \leq T_J \leq 125^{\circ}\text{C}$; $V_{IN} = 3.0\text{ V}$; $I_{OUT} = 1\text{ mA}$, $C_{IN} = C_{OUT} = 1.0\text{ }\mu\text{F}$, unless otherwise noted. Typical values are at $T_J = +25^{\circ}\text{C}$. (Note 13)

Parameter	Test Conditions	Symbol	Min	Typ	Max	Unit
Operating Input Voltage	$I_{OUT} \leq 10\text{ mA}$	V_{IN}	2.8		24	V
	$10\text{ mA} < I_{OUT} < 80\text{ mA}$		3.0		24	
Output Voltage Accuracy	$3.0\text{ V} < V_{IN} < 24\text{ V}$, $0 < I_{OUT} < 80\text{ mA}$	V_{OUT}	1.746	1.8	1.854	V
Turn-On Time	$I_{OUT} = 1\text{ mA}$	t_{ON}	–	700	–	μs
Undervoltage Lock-Out	V_{IN} rising	UVLO	–	2.1	–	V
Line Regulation	$3.0\text{ V} \leq V_{IN} \leq 24\text{ V}$, $I_{OUT} = 1\text{ mA}$	Reg _{LINE}		15		mV
Load Regulation	$I_{OUT} = 0\text{ mA}$ to 80 mA	Reg _{LOAD}		15		mV
Dropout voltage (Note 11)						
Maximum Output Current	(Note 14)	I_{OUT}	110			mA
Ground current	$0 < I_{OUT} < 80\text{ mA}$, $-40 < T_A < 85^{\circ}\text{C}$	I_{GND}		3.2	4.2	μA
	$0 < I_{OUT} < 80\text{ mA}$, $V_{IN} = 24\text{ V}$				5.8	μA
Power Supply Rejection Ratio	$V_{IN} = 3.0\text{ V}$, $V_{OUT} = 1.8\text{ V}$ $V_{PP} = 200\text{ mV}$ modulation $I_{OUT} = 1\text{ mA}$, $C_{OUT} = 10\text{ }\mu\text{F}$	$f = 100\text{ kHz}$		60		dB
Output Noise Voltage	$V_{OUT} = 1.8\text{ V}$, $I_{OUT} = 80\text{ mA}$ $f = 200\text{ Hz}$ to 100 kHz	V_N		140		μV_{rms}
Thermal Shutdown Temperature (Note 12)	Temperature increasing from $T_J = +25^{\circ}\text{C}$	T_{SD}		155		$^{\circ}\text{C}$
Thermal Shutdown Hysteresis (Note 12)	Temperature falling from T_{SD}	T_{SDH}	–	25	–	$^{\circ}\text{C}$

11. Not Characterized at $V_{IN} = 3.0\text{ V}$, $V_{OUT} = 1.8\text{ V}$, $I_{OUT} = 80\text{ mA}$

12. Guaranteed by design and characterization.

13. Performance guaranteed over the indicated operating temperature range by design and/or characterization production tested at $T_J = T_A = 25^{\circ}\text{C}$. Low duty cycle pulse techniques are used during testing to maintain the junction temperature as close to ambient as possible.

14. Respect SOA

NCP716

Table 7. ELECTRICAL CHARACTERISTICS Voltage version 2.5 V

$-40^{\circ}\text{C} \leq T_J \leq 125^{\circ}\text{C}$; $V_{IN} = 3.5\text{ V}$; $I_{OUT} = 1\text{ mA}$, $C_{IN} = C_{OUT} = 1.0\text{ }\mu\text{F}$, unless otherwise noted. Typical values are at $T_J = +25^{\circ}\text{C}$. (Note 17)

Parameter	Test Conditions	Symbol	Min	Typ	Max	Unit
Operating Input Voltage	$0 < I_{OUT} < 80\text{ mA}$	V_{IN}	3.5		24	V
Output Voltage Accuracy	$3.5\text{ V} < V_{IN} < 24\text{ V}$, $0 < I_{OUT} < 80\text{ mA}$	V_{OUT}	2.45	2.5	2.55	V
Turn-On Time	$I_{OUT} = 1\text{ mA}$	t_{ON}	–	700	–	μs
Undervoltage Lock-Out	V_{IN} rising	UVLO	–	2.1	–	V
Line Regulation	$V_{OUT} + 1\text{ V} \leq V_{IN} \leq 24\text{ V}$, $I_{OUT} = 1\text{ mA}$	RegLINE		15		mV
Load Regulation	$I_{OUT} = 0\text{ mA}$ to 80 mA	RegLOAD		15		mV
Dropout voltage (Note 15)	$V_{DO} = V_{IN} - (V_{OUT(NOM)} - 75\text{ mV})$ $I_{OUT} = 80\text{ mA}$	V_{DO}		400	640	mV
Maximum Output Current	(Note 18)	I_{OUT}	110			mA
Ground current	$0 < I_{OUT} < 80\text{ mA}$, $-40 < T_A < 85^{\circ}\text{C}$	I_{GND}		3.2	4.2	μA
	$0 < I_{OUT} < 80\text{ mA}$, $V_{IN} = 24\text{ V}$				5.8	μA
Power Supply Rejection Ratio	$V_{IN} = 3.5\text{ V}$, $V_{OUT} = 2.5\text{ V}$ $V_{PP} = 200\text{ mV}$ modulation $I_{OUT} = 1\text{ mA}$, $C_{OUT} = 10\text{ }\mu\text{F}$	$f = 100\text{ kHz}$	PSRR	60		dB
Output Noise Voltage	$V_{OUT} = 2.5\text{ V}$, $I_{OUT} = 80\text{ mA}$ $f = 200\text{ Hz}$ to 100 kHz	V_N		160		μV_{rms}
Thermal Shutdown Temperature (Note 16)	Temperature increasing from $T_J = +25^{\circ}\text{C}$	T_{SD}		155		$^{\circ}\text{C}$
Thermal Shutdown Hysteresis (Note 16)	Temperature falling from T_{SD}	T_{SDH}	–	25	–	$^{\circ}\text{C}$

15. Characterized when V_{OUT} falls 75 mV below the regulated voltage and only for devices with $V_{OUT} = 2.5\text{ V}$

16. Guaranteed by design and characterization.

17. Performance guaranteed over the indicated operating temperature range by design and/or characterization production tested at $T_J = T_A = 25^{\circ}\text{C}$. Low duty cycle pulse techniques are used during testing to maintain the junction temperature as close to ambient as possible.

18. Respect SOA

NCP716

Table 8. ELECTRICAL CHARACTERISTICS Voltage version 3.0 V

$-40^{\circ}\text{C} \leq T_J \leq 125^{\circ}\text{C}$; $V_{IN} = 4.0\text{ V}$; $I_{OUT} = 1\text{ mA}$, $C_{IN} = C_{OUT} = 1.0\text{ }\mu\text{F}$, unless otherwise noted. Typical values are at $T_J = +25^{\circ}\text{C}$. (Note 21)

Parameter	Test Conditions	Symbol	Min	Typ	Max	Unit
Operating Input Voltage	$0 < I_{OUT} < 80\text{ mA}$	V_{IN}	4.0		24	V
Output Voltage Accuracy	$4.3\text{ V} < V_{IN} < 24\text{ V}$, $0 < I_{OUT} < 80\text{ mA}$	V_{OUT}	2.94	3.0	3.06	V
Turn-On Time	$I_{OUT} = 1\text{ mA}$	t_{ON}	–	700	–	μs
Undervoltage Lock-Out	V_{IN} rising	UVLO	–	2.1	–	V
Line Regulation	$V_{OUT} + 1\text{ V} \leq V_{IN} \leq 24\text{ V}$, $I_{OUT} = 1\text{ mA}$	Reg _{LINE}		4	10	mV
Load Regulation	$I_{OUT} = 0\text{ mA}$ to 80 mA	Reg _{LOAD}		10	30	mV
Dropout voltage (Note 19)	$V_{DO} = V_{IN} - (V_{OUT(NOM)} - 90\text{ mV})$ $I_{OUT} = 80\text{ mA}$	V_{DO}		370	580	mV
Maximum Output Current	(Note 22)	I_{OUT}	110			mA
Ground current	$0 < I_{OUT} < 80\text{ mA}$, $-40 < T_A < 85^{\circ}\text{C}$	I_{GND}		3.2	4.2	μA
	$0 < I_{OUT} < 80\text{ mA}$, $V_{IN} = 24\text{ V}$				5.8	μA
Power Supply Rejection Ratio	$V_{IN} = 4.3\text{ V}$, $V_{OUT} = 3.3\text{ V}$ $V_{PP} = 200\text{ mV}$ modulation $I_{OUT} = 1\text{ mA}$, $C_{OUT} = 10\text{ }\mu\text{F}$	$f = 100\text{ kHz}$	PSRR	58		dB
Output Noise Voltage	$V_{OUT} = 4.3\text{ V}$, $I_{OUT} = 80\text{ mA}$ $f = 200\text{ Hz}$ to 100 kHz	V_N		190		μV_{rms}
Thermal Shutdown Temperature (Note 20)	Temperature increasing from $T_J = +25^{\circ}\text{C}$	T_{SD}		155		$^{\circ}\text{C}$
Thermal Shutdown Hysteresis (Note 20)	Temperature falling from T_{SD}	T_{SDH}	–	25	–	$^{\circ}\text{C}$

19. Characterized when V_{OUT} falls 90 mV below the regulated voltage and only for devices with $V_{OUT} = 3.0\text{ V}$

20. Guaranteed by design and characterization.

21. Performance guaranteed over the indicated operating temperature range by design and/or characterization production tested at $T_J = T_A = 25^{\circ}\text{C}$. Low duty cycle pulse techniques are used during testing to maintain the junction temperature as close to ambient as possible.

22. Respect SOA

NCP716

Table 9. ELECTRICAL CHARACTERISTICS Voltage version 3.3 V

$-40^{\circ}\text{C} \leq T_J \leq 125^{\circ}\text{C}$; $V_{IN} = 4.3\text{ V}$; $I_{OUT} = 1\text{ mA}$, $C_{IN} = C_{OUT} = 1.0\text{ }\mu\text{F}$, unless otherwise noted. Typical values are at $T_J = +25^{\circ}\text{C}$. (Note 25)

Parameter	Test Conditions	Symbol	Min	Typ	Max	Unit
Operating Input Voltage	$0 < I_{OUT} < 80\text{ mA}$	V_{IN}	4.3		24	V
Output Voltage Accuracy	$4.3\text{ V} < V_{IN} < 24\text{ V}$, $0 < I_{OUT} < 80\text{ mA}$	V_{OUT}	3.234	3.3	3.366	V
Turn-On Time	$I_{OUT} = 1\text{ mA}$	t_{ON}	–	700	–	μs
Undervoltage Lock-Out	V_{IN} rising	UVLO	–	2.1	–	V
Line Regulation	$V_{OUT} + 1\text{ V} \leq V_{IN} \leq 24\text{ V}$, $I_{OUT} = 1\text{ mA}$	Reg _{LINE}		4	10	mV
Load Regulation	$I_{OUT} = 0\text{ mA}$ to 80 mA	Reg _{LOAD}		10	30	mV
Dropout voltage (Note 23)	$V_{DO} = V_{IN} - (V_{OUT(NOM)} - 99\text{ mV})$ $I_{OUT} = 80\text{ mA}$	V_{DO}		350	560	mV
Maximum Output Current	(Note 26)	I_{OUT}	110			mA
Ground current	$0 < I_{OUT} < 80\text{ mA}$, $-40 < T_A < 85^{\circ}\text{C}$	I_{GND}		3.2	4.2	μA
	$0 < I_{OUT} < 80\text{ mA}$, $V_{IN} = 24\text{ V}$				5.8	μA
Power Supply Rejection Ratio	$V_{IN} = 4.3\text{ V}$, $V_{OUT} = 3.3\text{ V}$ $V_{PP} = 200\text{ mV}$ modulation $I_{OUT} = 1\text{ mA}$, $C_{OUT} = 10\text{ }\mu\text{F}$	$f = 100\text{ kHz}$	PSRR	60		dB
Output Noise Voltage	$V_{OUT} = 4.3\text{ V}$, $I_{OUT} = 80\text{ mA}$ $f = 200\text{ Hz}$ to 100 kHz	V_N		200		μV_{rms}
Thermal Shutdown Temperature (Note 24)	Temperature increasing from $T_J = +25^{\circ}\text{C}$	T_{SD}		155		$^{\circ}\text{C}$
Thermal Shutdown Hysteresis (Note 24)	Temperature falling from T_{SD}	T_{SDH}	–	25	–	$^{\circ}\text{C}$

23. Characterized when V_{OUT} falls 99 mV below the regulated voltage and only for devices with $V_{OUT} = 3.3\text{ V}$

24. Guaranteed by design and characterization.

25. Performance guaranteed over the indicated operating temperature range by design and/or characterization production tested at $T_J = T_A = 25^{\circ}\text{C}$. Low duty cycle pulse techniques are used during testing to maintain the junction temperature as close to ambient as possible.

26. Respect SOA

NCP716

Table 10. ELECTRICAL CHARACTERISTICS Voltage version 5.0 V

$-40^{\circ}\text{C} \leq T_J \leq 125^{\circ}\text{C}$; $V_{IN} = 6.0\text{ V}$; $I_{OUT} = 1\text{ mA}$, $C_{IN} = C_{OUT} = 1.0\text{ }\mu\text{F}$, unless otherwise noted. Typical values are at $T_J = +25^{\circ}\text{C}$. (Note 29)

Parameter	Test Conditions	Symbol	Min	Typ	Max	Unit
Operating Input Voltage	$0 < I_{OUT} < 80\text{ mA}$	V_{IN}	6.0		24	V
Output Voltage Accuracy	$6.0\text{ V} < V_{IN} < 24\text{ V}$, $0 < I_{OUT} < 80\text{ mA}$	V_{OUT}	4.9	5.0	5.1	V
Turn-On Time	$I_{OUT} = 1\text{ mA}$	t_{ON}	–	700	–	μs
Undervoltage Lock-Out	V_{IN} rising	UVLO	–	2.1	–	V
Line Regulation	$V_{OUT} + 1\text{ V} \leq V_{IN} \leq 24\text{ V}$, $I_{OUT} = 1\text{ mA}$	RegLINE		4	10	mV
Load Regulation	$I_{OUT} = 0\text{ mA}$ to 80 mA	RegLOAD		10	30	mV
Dropout voltage (Note 27)	$V_{DO} = V_{IN} - (V_{OUT(NOM)} - 150\text{ mV})$ $I_{OUT} = 80\text{ mA}$	V_{DO}		310	500	mV
Maximum Output Current	(Note 30)	I_{OUT}	110			mA
Ground current	$0 < I_{OUT} < 80\text{ mA}$, $-40 < T_A < 85^{\circ}\text{C}$	I_{GND}		3.2	4.2	μA
	$0 < I_{OUT} < 80\text{ mA}$, $V_{IN} = 24\text{ V}$				5.8	μA
Power Supply Rejection Ratio	$V_{IN} = 6.0\text{ V}$, $V_{OUT} = 5.0\text{ V}$ $V_{PP} = 200\text{ mV}$ modulation $I_{OUT} = 1\text{ mA}$, $C_{OUT} = 10\text{ }\mu\text{F}$	$f = 100\text{ kHz}$	PSRR	54		dB
Output Noise Voltage	$V_{OUT} = 5.0\text{ V}$, $I_{OUT} = 80\text{ mA}$ $f = 200\text{ Hz}$ to 100 kHz	V_N		220		μV_{rms}
Thermal Shutdown Temperature (Note 28)	Temperature increasing from $T_J = +25^{\circ}\text{C}$	T_{SD}		155		$^{\circ}\text{C}$
Thermal Shutdown Hysteresis (Note 28)	Temperature falling from T_{SD}	T_{SDH}	–	25	–	$^{\circ}\text{C}$

27. Characterized when V_{OUT} falls 150 mV below the regulated voltage and only for devices with $V_{OUT} = 5.0\text{ V}$

28. Guaranteed by design and characterization.

29. Performance guaranteed over the indicated operating temperature range by design and/or characterization production tested at $T_J = T_A = 25^{\circ}\text{C}$. Low duty cycle pulse techniques are used during testing to maintain the junction temperature as close to ambient as possible.

30. Respect SOA

NCP716

TYPICAL CHARACTERISTICS

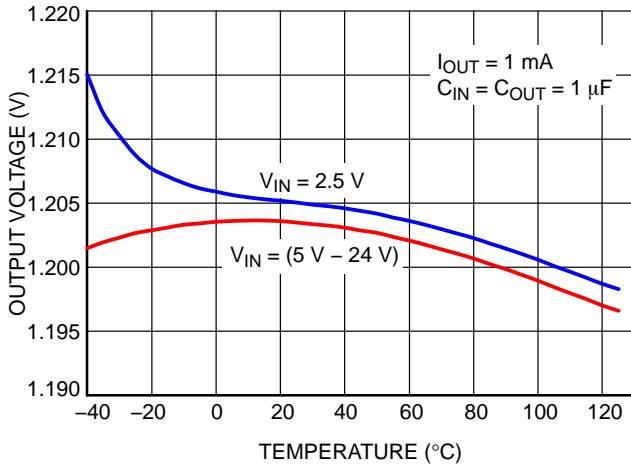

Figure 3. NCP716x12xxx Output Voltage vs. Temperature

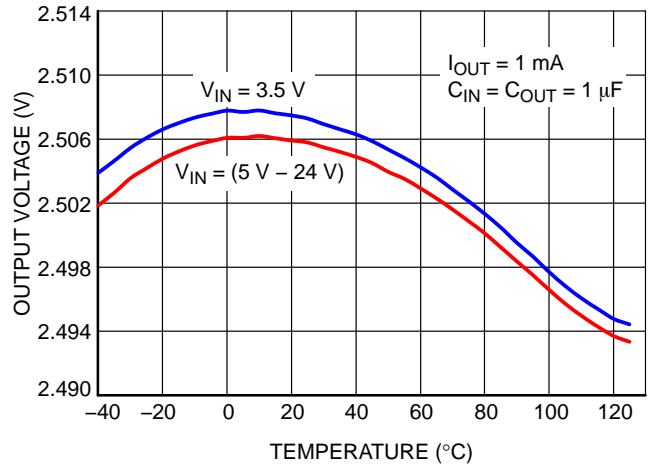

Figure 4. NCP716x25xxx Output Voltage vs. Temperature

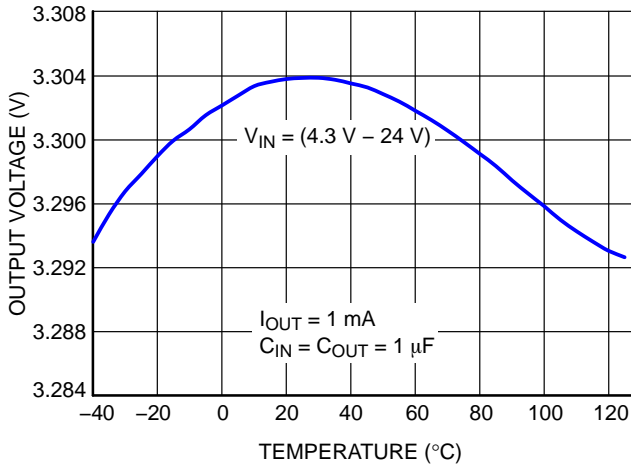

Figure 5. NCP716x33xxx Output Voltage vs. Temperature

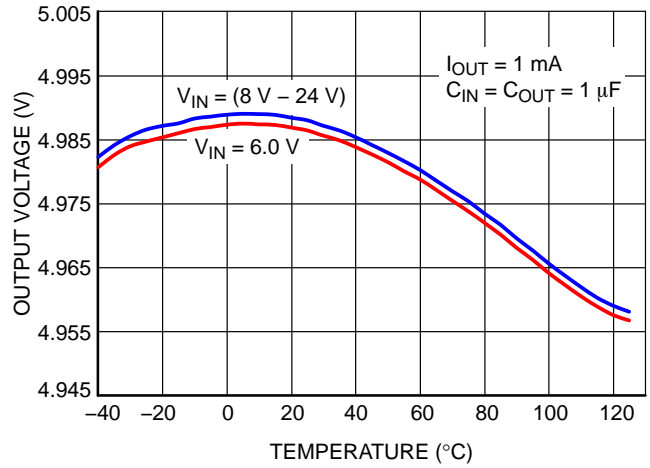

Figure 6. NCP716x50xxx Output Voltage vs. Temperature

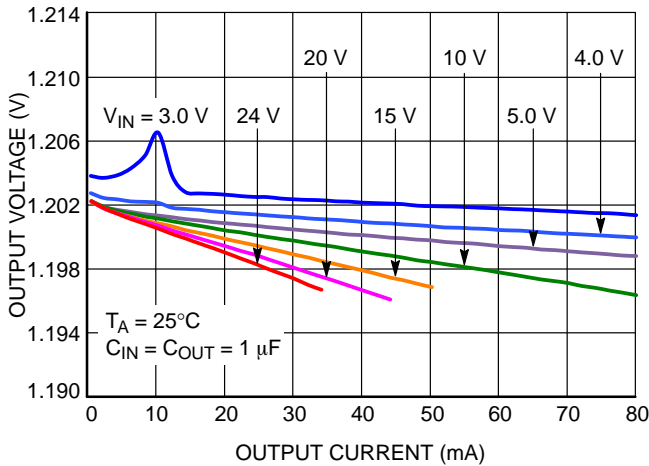

Figure 7. NCP716x12xxx Output Voltage vs. Output Current

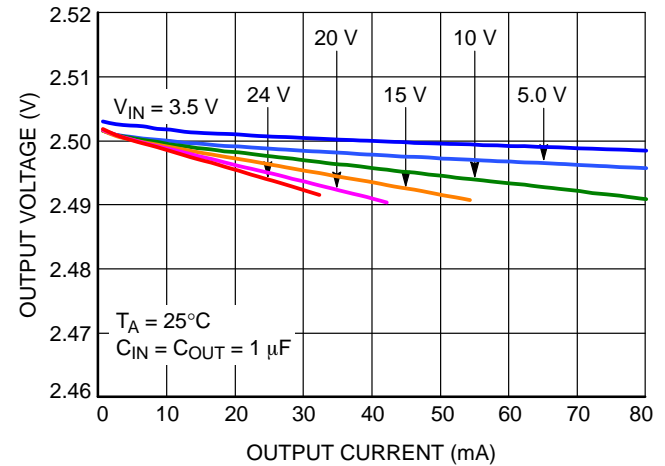

Figure 8. NCP716x25xxx Output Voltage vs. Output Current

NCP716

TYPICAL CHARACTERISTICS

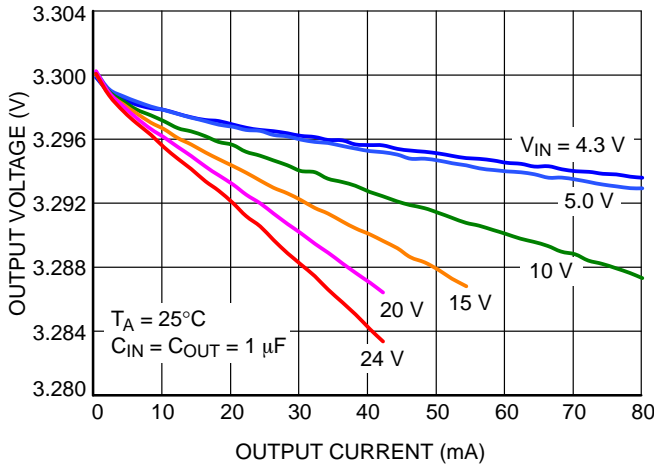

Figure 9. NCP7163V3 Output Voltage vs. Output Current

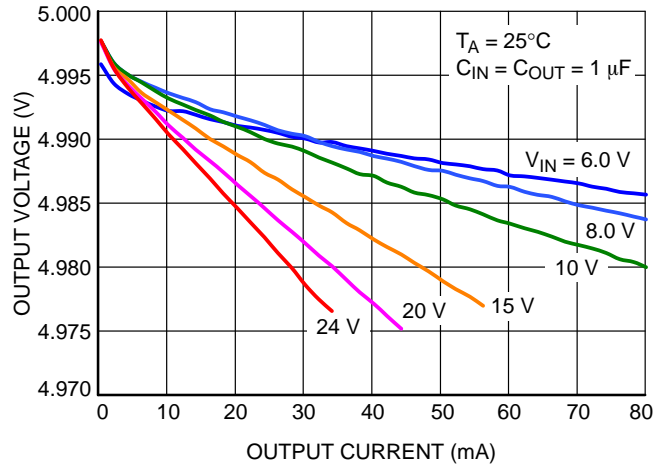

Figure 10. NCP716x50xxx Output Voltage vs. Output Current

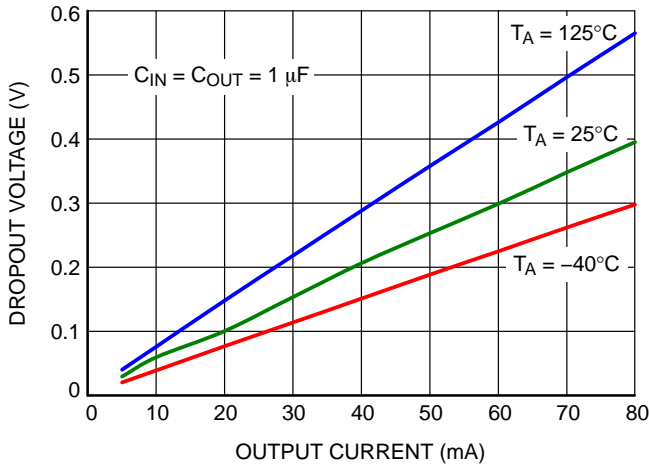

Figure 11. NCP716x25xxx Dropout Voltage vs. Output Current

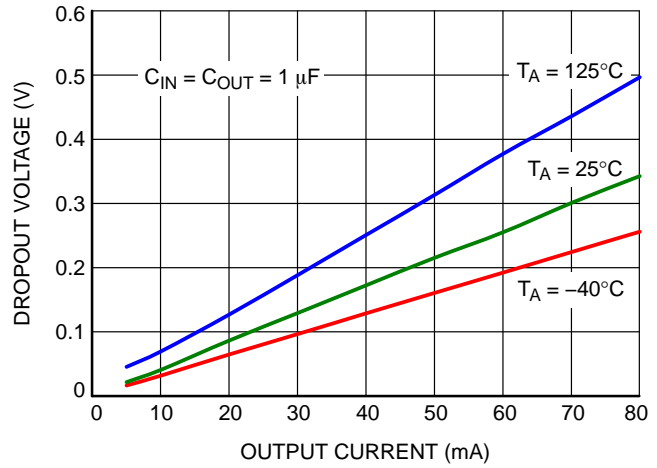

Figure 12. NCP716x33xxx Dropout Voltage vs. Output Current

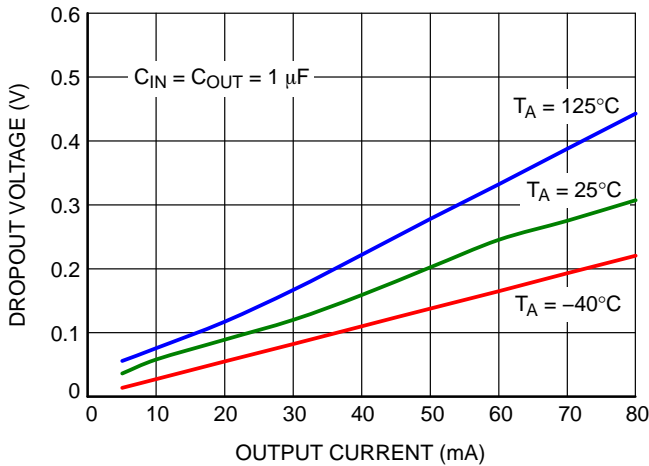

Figure 13. NCP716x50xxx Dropout Voltage vs. Output Current

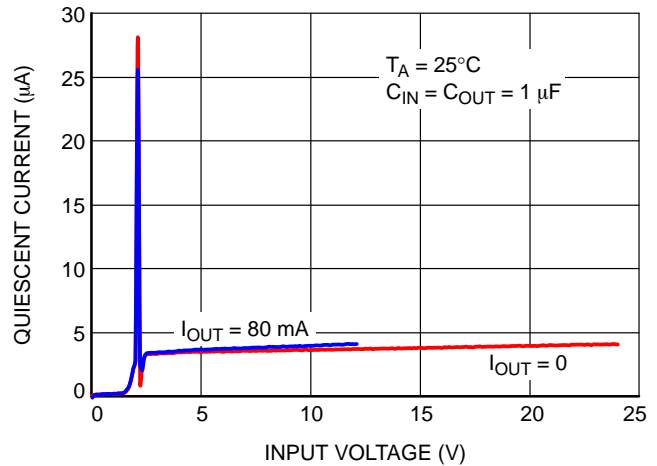

Figure 14. NCP716x12xxx Ground Current vs. Input Voltage

NCP716

TYPICAL CHARACTERISTICS

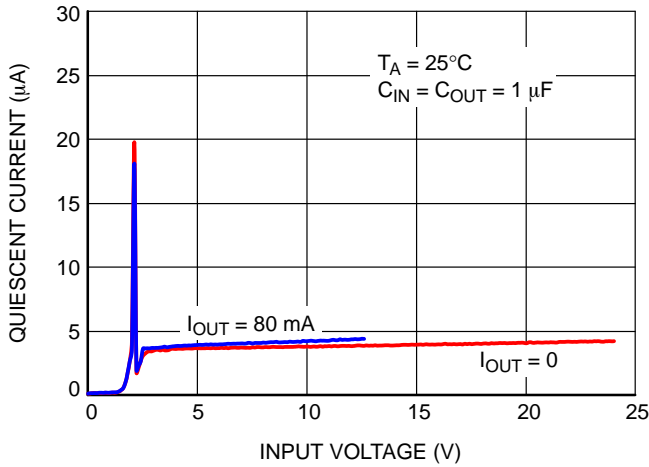

Figure 15. NCP716x25xxx Ground Current vs. Input Voltage

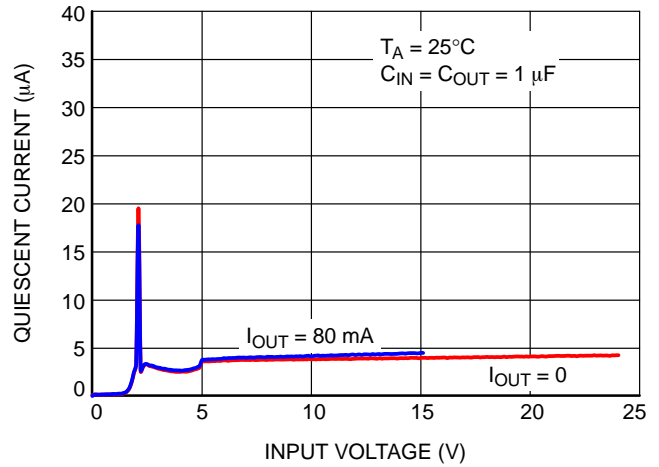

Figure 16. NCP716x50xxx Ground Current vs. Input Voltage

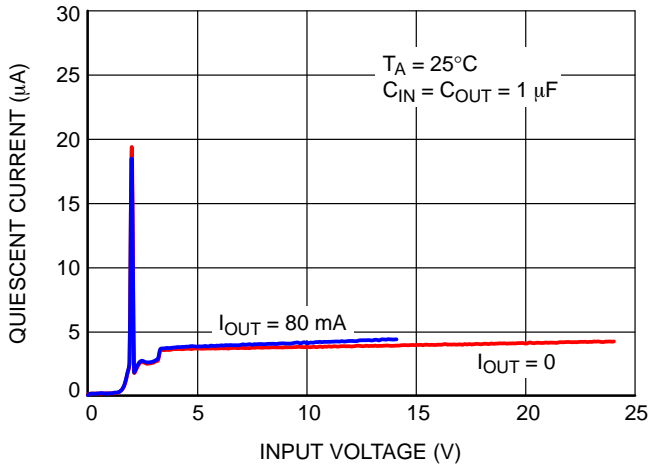

Figure 17. NCP716x33xxx Ground Current vs. Input Voltage

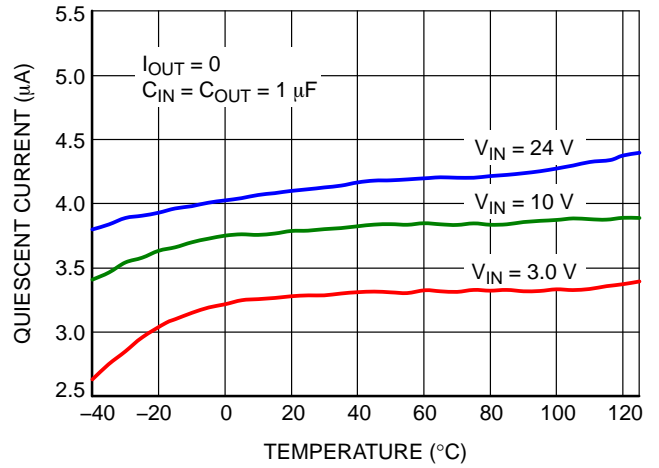

Figure 18. NCP716x12xxx Quiescent Current vs. Temperature

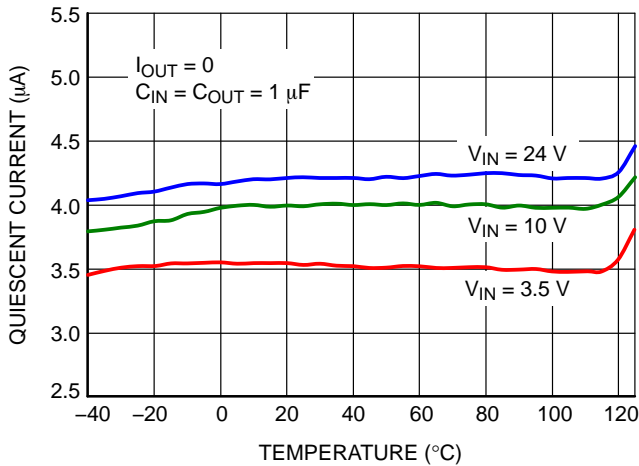

Figure 19. NCP716x25xxx Quiescent Current vs. Temperature

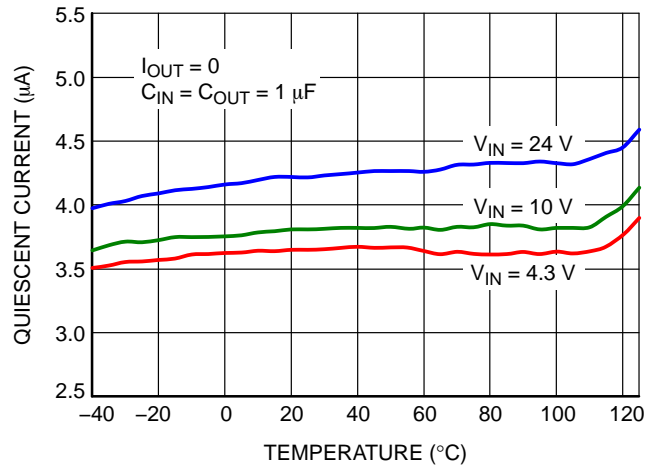

Figure 20. NCP716x33xxx Quiescent Current vs. Temperature

NCP716

TYPICAL CHARACTERISTICS

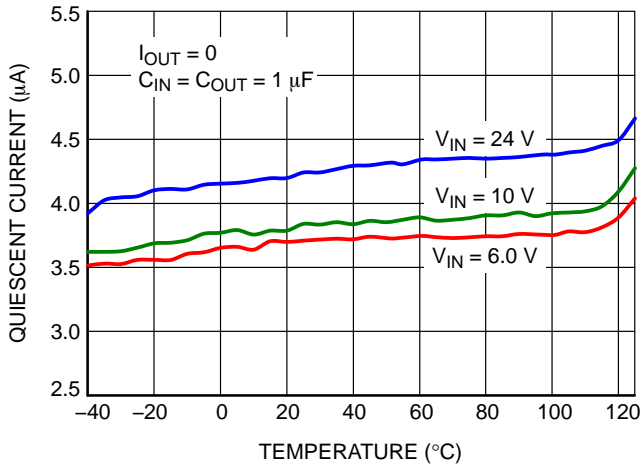

Figure 21. NCP716x50xxx Quiescent Current vs. Temperature

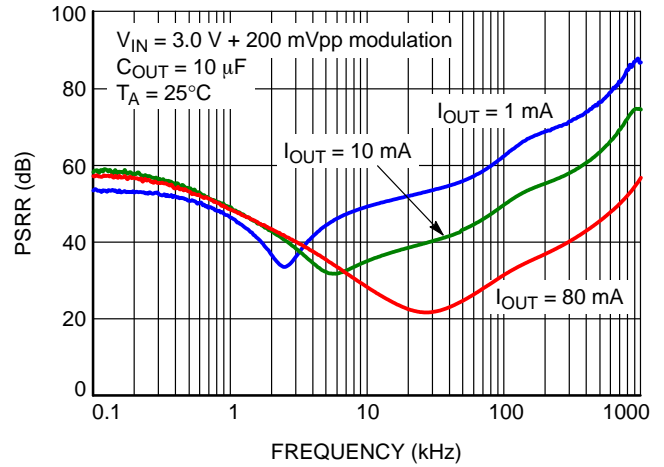

Figure 22. NCP716x12xxx PSRR vs. Frequency

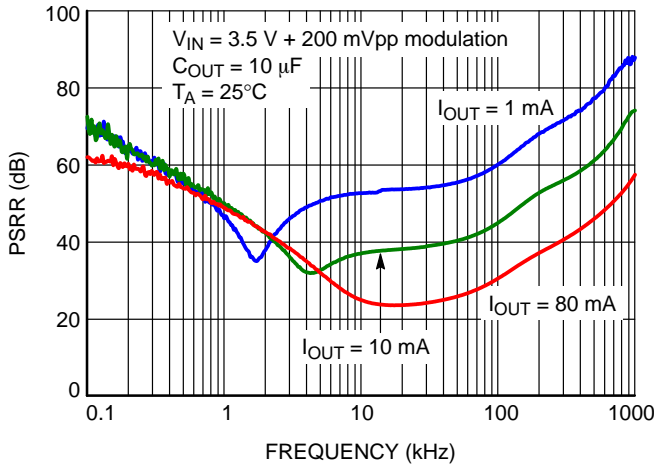

Figure 23. NCP716x25xxx PSRR vs. Frequency

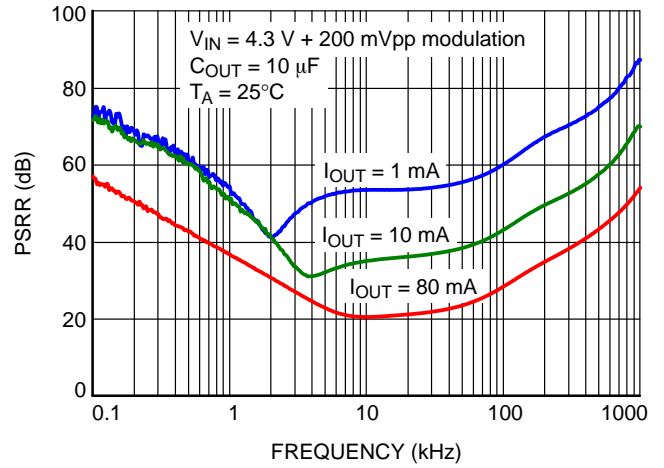

Figure 24. NCP716x33xxx PSRR vs. Frequency

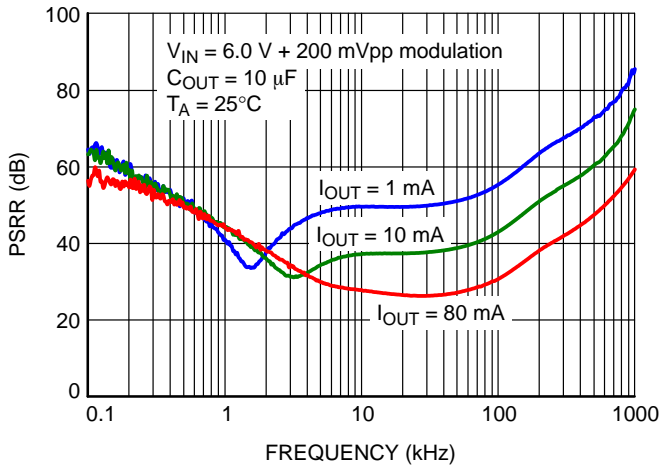

Figure 25. NCP716x50xxx PSRR vs. Frequency

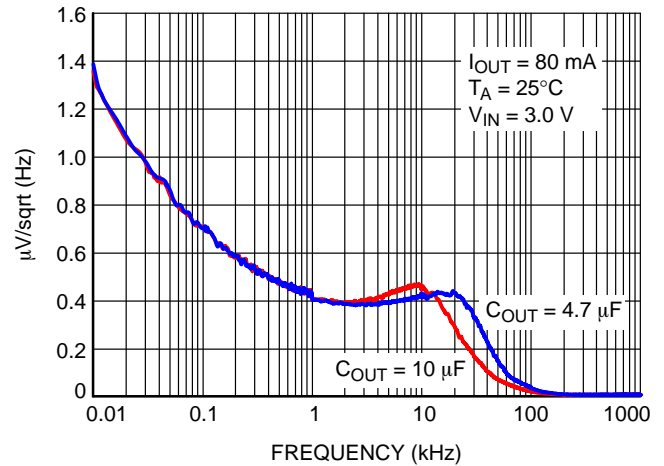

Figure 26. NCP716x12xxx Output Spectral Noise Density vs. Frequency

NCP716

TYPICAL CHARACTERISTICS

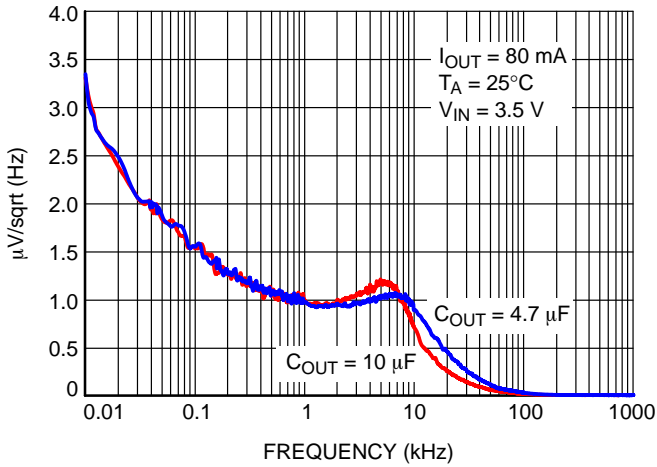

Figure 27. NCP716x25xxx Output Spectral Noise Density vs. Frequency

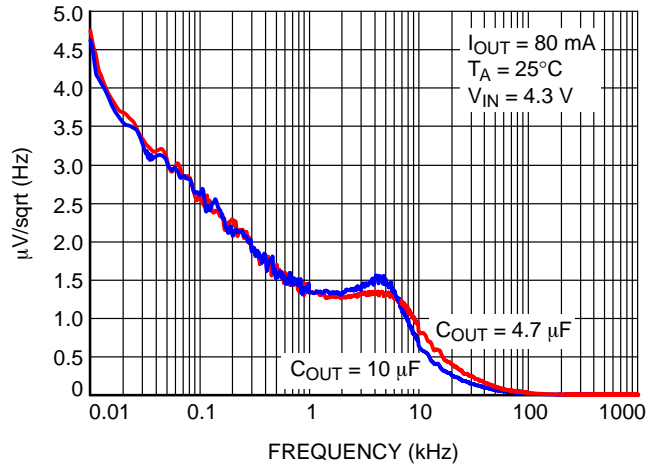

Figure 28. NCP716x33xxx Output Spectral Noise Density vs. Frequency

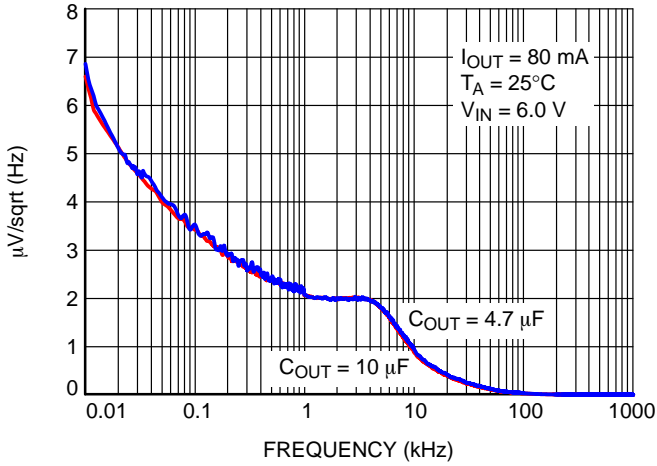

Figure 29. NCP716x50xxx Output Spectral Noise Density vs. Frequency

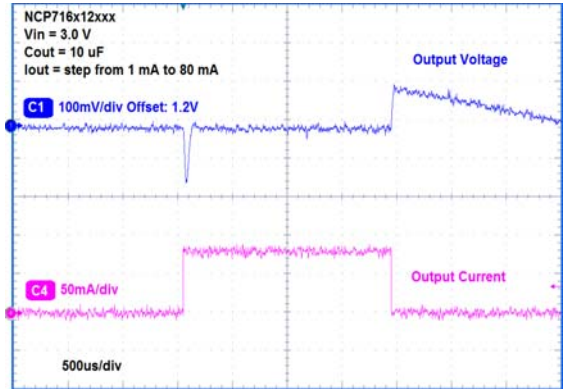

Figure 30. Load Transient Response

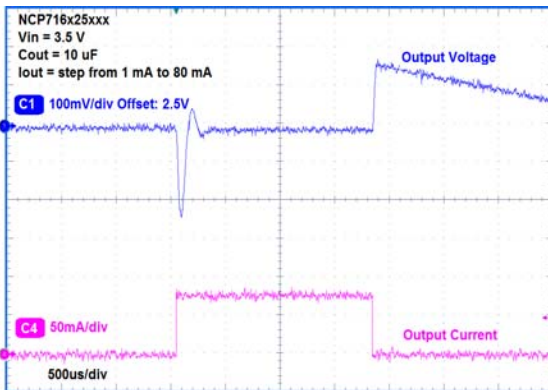

Figure 31. Load Transient Response

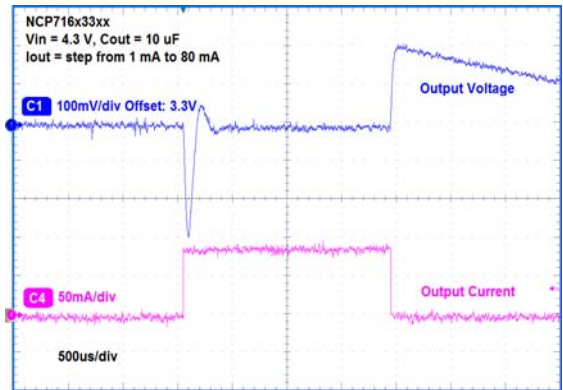

Figure 32. Load Transient Response

NCP716

TYPICAL CHARACTERISTICS

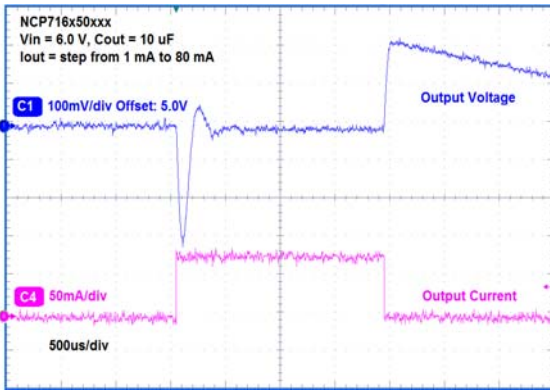

Figure 33. Load Transient Response

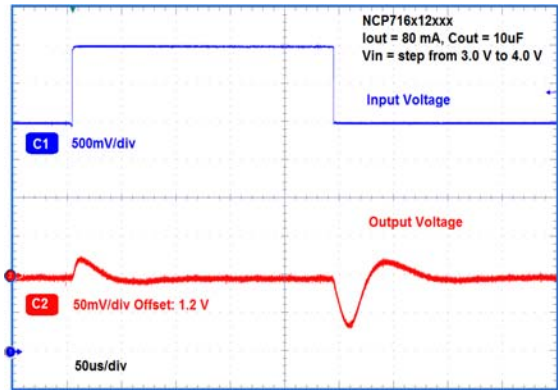

Figure 34. Line Transient Response

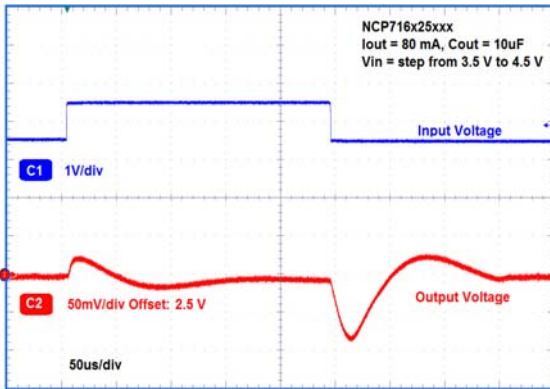

Figure 35. Line Transient Response

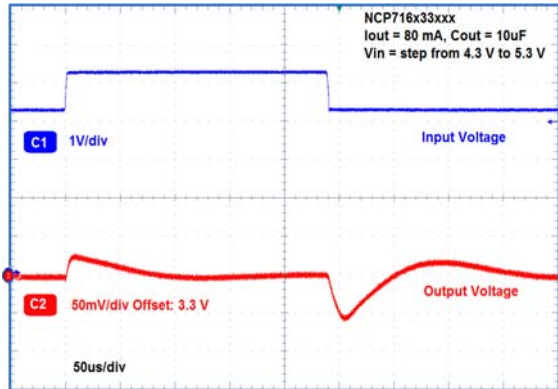

Figure 36. Line Transient Response

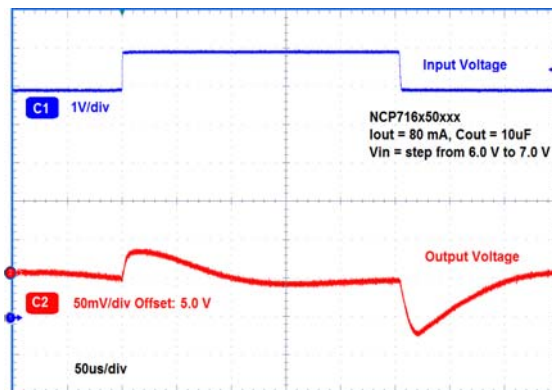

Figure 37. Line Transient Response

NCP716

TYPICAL CHARACTERISTICS

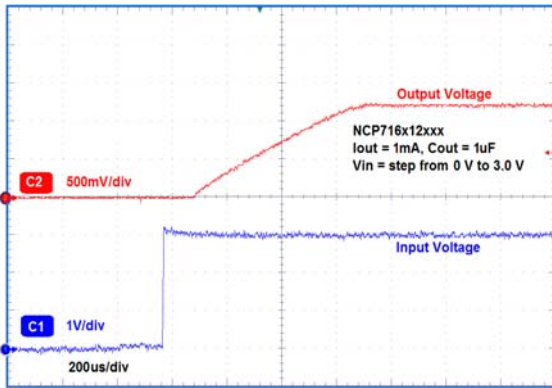

Figure 38. Input Voltage Turn-On Response

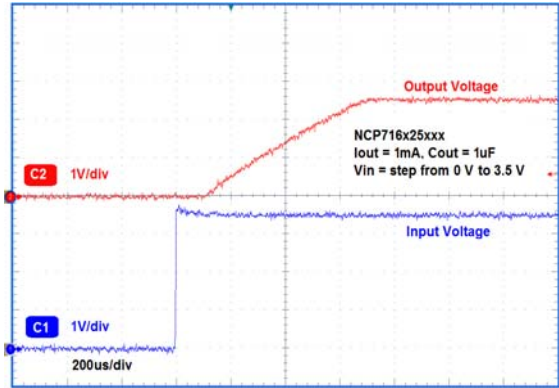

Figure 39. Input Voltage Turn-On Response

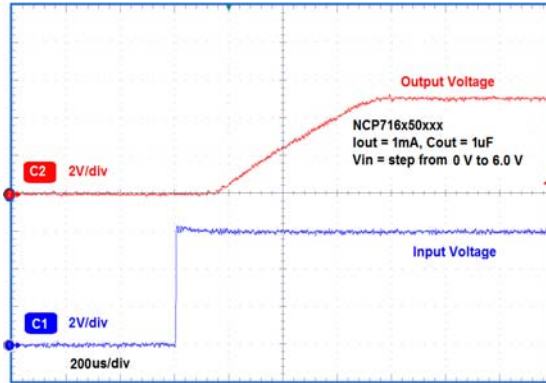

Figure 40. Input Voltage Turn-On Response

NCP716

APPLICATIONS INFORMATION

The NCP716 is the member of new family of Wide Input Voltage Range Low Dropout Regulators which delivers Ultra Low Ground Current consumption, Good Noise and Power Supply Rejection Ratio Performance.

Input Decoupling (C_{IN})

It is recommended to connect at least 0.1 μ F Ceramic X5R or X7R capacitor between IN and GND pin of the device. This capacitor will provide a low impedance path for any unwanted AC signals or Noise superimposed onto constant Input Voltage. The good input capacitor will limit the influence of input trace inductances and source resistance during sudden load current changes.

Higher capacitance and lower ESR Capacitors will improve the overall line transient response.

Output Decoupling (C_{OUT})

The NCP716 does not require a minimum Equivalent Series Resistance (ESR) for the output capacitor. The device is designed to be stable with standard ceramics capacitors with values of 0.47 μ F or greater up to 10 μ F. The X5R and X7R types have the lowest capacitance variations over temperature thus they are recommended.

Power Dissipation and Heat sinking

The maximum power dissipation supported by the device is dependent upon board design and layout. Mounting pad configuration on the PCB, the board material, and the ambient temperature affect the rate of junction temperature rise for the part. The maximum power dissipation the NCP716 can handle is given by:

$$P_{D(MAX)} = \frac{[T_{J(MAX)} - T_A]}{R_{\theta JA}} \quad (\text{eq. 1})$$

The power dissipated by the NCP716 for given application conditions can be calculated from the following equations:

$$P_D \approx V_{IN}(I_{GND} + I_{OUT}) + I_{OUT}(V_{IN} - V_{OUT}) \quad (\text{eq. 2})$$

or

$$V_{IN(MAX)} \approx \frac{P_{D(MAX)} + (V_{OUT} \times I_{OUT})}{I_{OUT} + I_{GND}} \quad (\text{eq. 3})$$

For reliable operation, junction temperature should be limited to +125°C maximum.

Hints

V_{IN} and GND printed circuit board traces should be as wide as possible. When the impedance of these traces is high, there is a chance to pick up noise or cause the regulator to malfunction. Place external components, especially the output capacitor, as close as possible to the NCP716, and make traces as short as possible.

ORDERING INFORMATION

Device	Voltage Option	Marking	Package	Shipping†
NCP716MT12TBG	1.2 V	6A	WDFN6 (Pb-Free)	3000 / Tape & Reel
NCP716MT15TG	1.5 V	6C		
NCP716MT18TBG	1.8 V	6D		
NCP716MT25TBG	2.5 V	6E		
NCP716MT30TBG	3.0 V	6F		
NCP716MT33TBG	3.3 V	6G		
NCP716MT50TBG	5.0 V	6H		
NCP716MTG50TBG	5.0 V	GH		

†For information on tape and reel specifications, including part orientation and tape sizes, please refer to our Tape and Reel Packaging Specifications Brochure, BRD8011/D.

MECHANICAL CASE OUTLINE

PACKAGE DIMENSIONS

ON Semiconductor®



SCALE 4:1

WDFN6 2x2, 0.65P
CASE 511BR
ISSUE B

DATE 19 JAN 2016

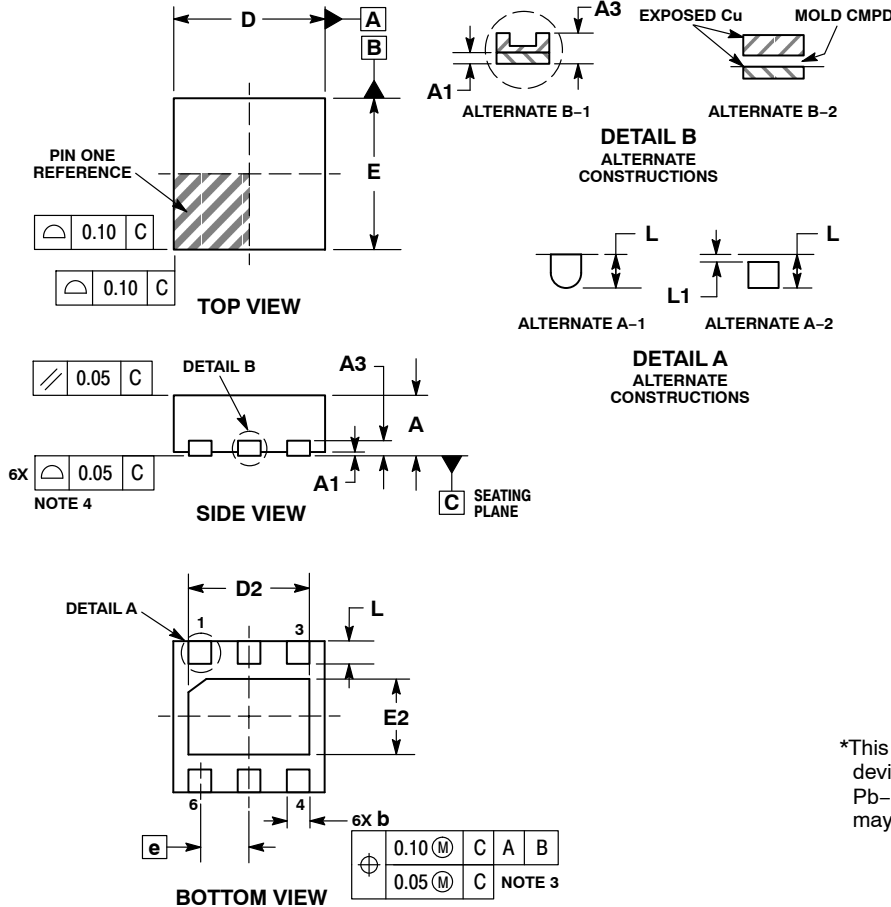

- NOTES:
1. DIMENSIONING AND TOLERANCING PER ASME Y14.5M, 1994.
 2. CONTROLLING DIMENSION: MILLIMETERS.
 3. DIMENSION b APPLIES TO PLATED TERMINAL AND IS MEASURED BETWEEN 0.15 AND 0.25 mm FROM THE TERMINAL TIP.
 4. COPLANARITY APPLIES TO THE EXPOSED PAD AS WELL AS THE TERMINALS.
 5. FOR DEVICES CONTAINING WETTABLE FLANK OPTION, DETAIL A ALTERNATE CONSTRUCTION A-2 AND DETAIL B ALTERNATE CONSTRUCTION B-2 ARE NOT APPLICABLE.

DIM	MILLIMETERS	
	MIN	MAX
A	0.70	0.80
A1	0.00	0.05
A3	0.20	REF
b	0.25	0.35
D	2.00 BSC	
D2	1.50	1.70
E	2.00 BSC	
E2	0.90	1.10
e	0.65 BSC	
L	0.20	0.40
L1	---	0.15

GENERIC MARKING DIAGRAM*

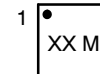

XX = Specific Device Code
M = Date Code

*This information is generic. Please refer to device data sheet for actual part marking. Pb-Free indicator, "G" or microdot "▪", may or may not be present.

RECOMMENDED MOUNTING FOOTPRINT

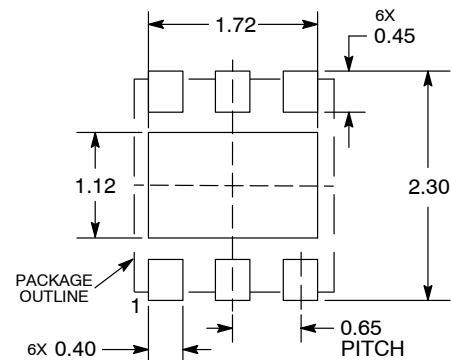

DIMENSIONS: MILLIMETERS

DOCUMENT NUMBER:	98AON55829E	Electronic versions are uncontrolled except when accessed directly from the Document Repository. Printed versions are uncontrolled except when stamped "CONTROLLED COPY" in red.
DESCRIPTION:	WDFN6 2X2, 0.65P	PAGE 1 OF 1

ON Semiconductor and are trademarks of Semiconductor Components Industries, LLC dba ON Semiconductor or its subsidiaries in the United States and/or other countries. ON Semiconductor reserves the right to make changes without further notice to any products herein. ON Semiconductor makes no warranty, representation or guarantee regarding the suitability of its products for any particular purpose, nor does ON Semiconductor assume any liability arising out of the application or use of any product or circuit, and specifically disclaims any and all liability, including without limitation special, consequential or incidental damages. ON Semiconductor does not convey any license under its patent rights nor the rights of others.

ON Semiconductor and  are trademarks of Semiconductor Components Industries, LLC dba ON Semiconductor or its subsidiaries in the United States and/or other countries. ON Semiconductor owns the rights to a number of patents, trademarks, copyrights, trade secrets, and other intellectual property. A listing of ON Semiconductor's product/patent coverage may be accessed at www.onsemi.com/site/pdf/Patent-Marking.pdf. ON Semiconductor reserves the right to make changes without further notice to any products herein. ON Semiconductor makes no warranty, representation or guarantee regarding the suitability of its products for any particular purpose, nor does ON Semiconductor assume any liability arising out of the application or use of any product or circuit, and specifically disclaims any and all liability, including without limitation special, consequential or incidental damages. Buyer is responsible for its products and applications using ON Semiconductor products, including compliance with all laws, regulations and safety requirements or standards, regardless of any support or applications information provided by ON Semiconductor. "Typical" parameters which may be provided in ON Semiconductor data sheets and/or specifications can and do vary in different applications and actual performance may vary over time. All operating parameters, including "Typicals" must be validated for each customer application by customer's technical experts. ON Semiconductor does not convey any license under its patent rights nor the rights of others. ON Semiconductor products are not designed, intended, or authorized for use as a critical component in life support systems or any FDA Class 3 medical devices or medical devices with a same or similar classification in a foreign jurisdiction or any devices intended for implantation in the human body. Should Buyer purchase or use ON Semiconductor products for any such unintended or unauthorized application, Buyer shall indemnify and hold ON Semiconductor and its officers, employees, subsidiaries, affiliates, and distributors harmless against all claims, costs, damages, and expenses, and reasonable attorney fees arising out of, directly or indirectly, any claim of personal injury or death associated with such unintended or unauthorized use, even if such claim alleges that ON Semiconductor was negligent regarding the design or manufacture of the part. ON Semiconductor is an Equal Opportunity/Affirmative Action Employer. This literature is subject to all applicable copyright laws and is not for resale in any manner.

PUBLICATION ORDERING INFORMATION

LITERATURE FULFILLMENT:

Email Requests to: orderlit@onsemi.com

ON Semiconductor Website: www.onsemi.com

TECHNICAL SUPPORT

North American Technical Support:
Voice Mail: 1 800-282-9855 Toll Free USA/Canada
Phone: 011 421 33 790 2910

Europe, Middle East and Africa Technical Support:

Phone: 00421 33 790 2910

For additional information, please contact your local Sales Representative