

NCP4352

Secondary Side SMPS ECO Mode Controller for Low Standby Power

The NCP4352 is a secondary side SMPS controller designed for use in applications which require extremely low consumption. The device is capable of detecting “light load” conditions and entering the power supply into low consumption “ECO mode”.

During ECO mode, the output voltage decreases to an adjustable level, allowing higher efficiency for light load condition while keeping lower but regulated voltage supply. Once more energy is required, the NCP4352 automatically switches back to the normal mode regulation of output voltage.

During normal power supply operation, the NCP4352 provides integrated voltage and current feedback regulation, replacing the need for a shunt regulator. Feedback control is provided through optocoupler to primary side SMPS controller.

The NCP4352 is available in TSOP–6 package.

Features

- Operating Input Voltage Range: 2.5 V to 36.0 V
- Supply Current < 155 μ A
- $\pm 0.5\%$ Reference Voltage Accuracy ($T_J = 25^\circ\text{C}$)
- Constant Voltage Control Loop
- Constant Current Control Loop
- Designed for Use with Any Primary SMPS Controller
- These are Pb–free Devices

Typical Applications

- Offline Adapters for Notebooks, Game Stations and Printers
- High Power AC–DC Converters for TVs, Set–Top Boxes, Monitors etc.



ON Semiconductor®

www.onsemi.com

MARKING DIAGRAM



TSOP–6
SN SUFFIX
CASE 318G

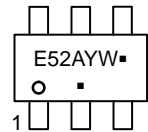

E52 = Specific Device Code
A = Assembly Location
Y = Year
W = Work Week
▪ = Pb–Free Package

(Note: Microdot may be in either location)

PIN CONNECTIONS

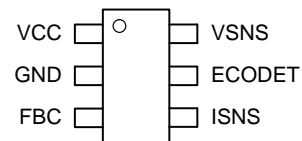

(Top View)

ORDERING INFORMATION

See detailed ordering and shipping information on page 9 of this data sheet.

NCP4352

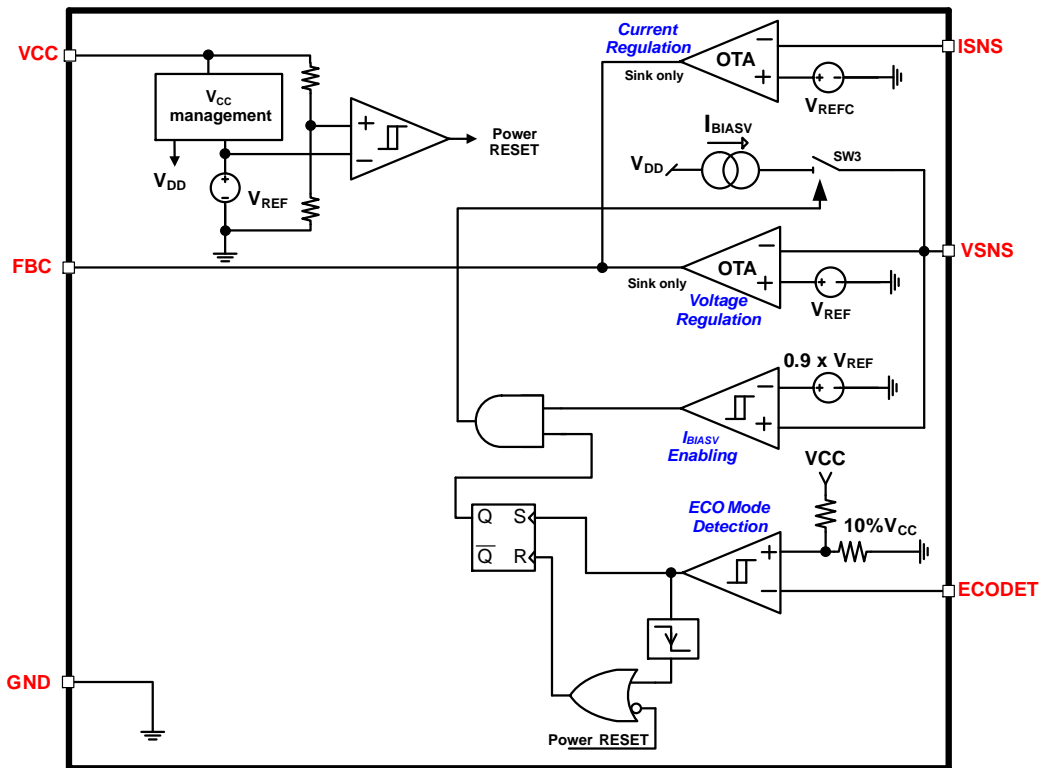

Figure 1. Simplified Block Diagram

Table 1. PIN FUNCTION DESCRIPTION

NCP4352	Pin Name	Description
1	VCC	Supply voltage pin
2	GND	Ground
6	VSNS	Output voltage sensing pin, connected to output voltage divider
5	ECODET	ECO mode detection input. Voltage divider provides adjustable ECO mode detection threshold
4	ISNS	Current sensing input for output current regulation, connect it to shunt resistor in ground branch.
3	FBC	Output of current sinking OTA amplifiers driving feedback optocoupler's LED. Connect here compensation network (networks) as well.

Table 2. ABSOLUTE MAXIMUM RATINGS

Rating	Symbol	Value	Unit
Input Voltage	V_{CC}	-0.3 to 40.0	V
FBC Voltage	V_{FBC}	-0.3 to $V_{CC} + 0.3$	V
VSNS, ISNS, ECODET Voltage	$V_{VSNS}, V_{ISNS}, V_{ECODET}$	-0.3 to 10.0	V
Thermal Resistance – Junction-to-Air (Note 1)	$R_{\theta JA}$	315	°C/W
Junction Temperature	T_J	-40 to 150	°C
Storage Temperature	T_{STG}	-60 to 150	°C
ESD Capability, Human Body Model (Note 1)	ESD _{HBM}	2000	V
ESD Capability, Machine Model (Note 1)	ESD _{MM}	250	V
ESD Capability, Charged Device Model (Note 1)	ESD _{CDM}	1000	V

Stresses exceeding those listed in the Maximum Ratings table may damage the device. If any of these limits are exceeded, device functionality should not be assumed, damage may occur and reliability may be affected.

1. 50 mm², 1.0 oz. Copper spreader.

2. This device series incorporates ESD protection and is tested by the following methods:

ESD Human Body Model tested per JESD22A-114F

ESD Charged Device Model tested per JESD22-C101F

Latch-up Current Maximum Rating tested per JEDEC standard: JESD78 class I.

NCP4352

Table 3. RECOMMENDED OPERATING CONDITIONS

Parameter	Symbol	Min	Max	Unit
Maximum Operating Input Voltage	V_{CCMAX}		36.0	V
Operating Junction Temperature	T_J	-40	125	°C

Functional operation above the stresses listed in the Recommended Operating Ranges is not implied. Extended exposure to stresses beyond the Recommended Operating Ranges limits may affect device reliability.

Table 4. ELECTRICAL CHARACTERISTICS

-40°C ≤ T_J ≤ 125°C; $V_{CC} = 15$ V; unless otherwise noted. Typical values are at $T_J = +25$ °C.

Parameter	Test Conditions	Symbol	Min	Typ	Max	Unit
VCC UVLO	V_{CC} rising	V_{CCUVLO}	3.3	3.5	3.7	V
	V_{CC} falling		2.3	2.5	2.7	
VCC UVLO Hysteresis		$V_{CCUVLOHYS}$	0.8	1.0		V
Quiescent Current	$V_{ECODET} = 2$ V, In regulation	I_{CC}		105	140	μA
	$V_{ECODET} = 0$ V, $V_{SNS} < V_{SNSBIAS}$			90	125	
	$V_{ECODET} = 1$ V, In regulation			120	155	

VOLTAGE CONTROL LOOP OTA

Transconductance	Sink current only	g_{mV}		1		S
Reference Voltage	2.8 V ≤ V_{CC} ≤ 36.0 V, $T_J = 25$ °C	V_{REF}	1.244	1.250	1.256	V
	2.8 V ≤ V_{CC} ≤ 36.0 V, $T_J = 0 - 125$ °C		1.230	1.250	1.270	
Sink Current Capability	$V_{FBC} > 1.5$ V, $V_{ECODET} = 2$ V	I_{SINKV}	2.5	3.0	3.5	mA
	$V_{FBC} > 1.5$ V, $V_{ECODET} = 1$ V		1.2	1.5	2.0	
Inverting Input Bias Current	$V_{SNS} = V_{REF}$, $V_{ECODET} = 2$ V	I_{BIASV}	-100		100	nA
	$V_{SNS} > V_{SNSBIAS}$, $V_{ECODET} = 1$ V		-35	-31	-27	μA
Inverting Input Bias Current Threshold	$V_{ECODET} = 1$ V	$V_{SNSBIAS}$	1.07	1.12	1.17	V

CURRENT CONTROL LOOP OTA

Transconductance	Sink current only	g_{mC}		3		S
Reference Voltage		V_{REFC}	60.0	62.5	65.0	mV
Sink Current Capability	$V_{FBC} > 1.5$ V, $V_{ECODET} = 2$ V	I_{SINKC}	2.5	3.0	3.5	mA
Inverting Input Bias Current	$V_{ISNS} = V_{REFC}$	I_{BIASC}	-100		100	nA

ECO MODE DETECTION COMPARATOR

Threshold Value	2.5 V ≤ V_{CC} ≤ 36.0 V	$V_{ECODETTH}$		10% V_{CC}		V
	$V_{CC} = 15$ V		1.47	1.50	1.53	
Hysteresis	Output change from logic high to logic low	$V_{ECODETH}$		40		mV

Product parametric performance is indicated in the Electrical Characteristics for the listed test conditions, unless otherwise noted. Product performance may not be indicated by the Electrical Characteristics if operated under different conditions.

TYPICAL CHARACTERISTICS

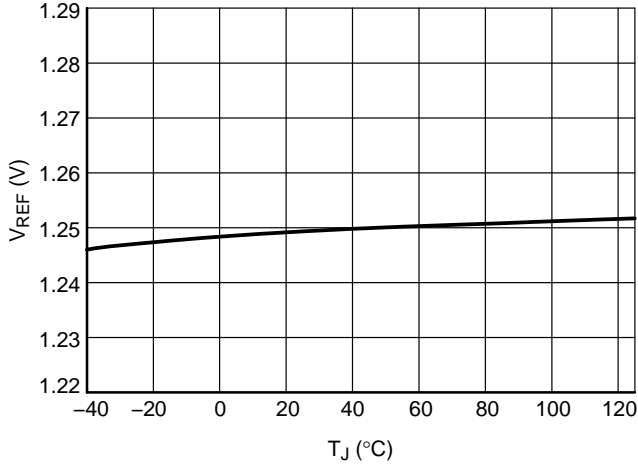

Figure 2. V_{REF} at V_{CC} = 15 V

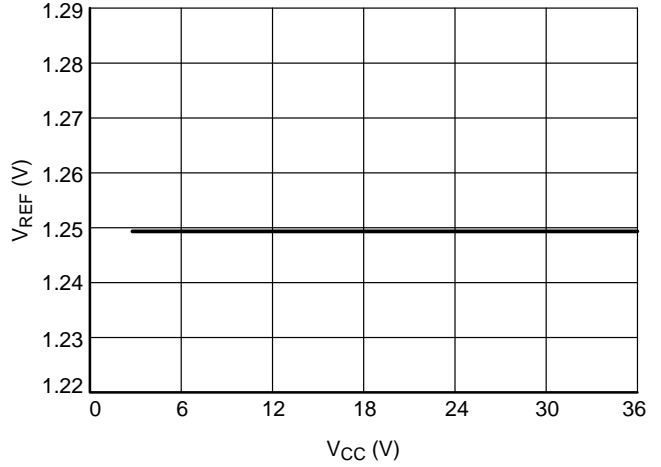

Figure 3. V_{REF} at T_J = 25°C

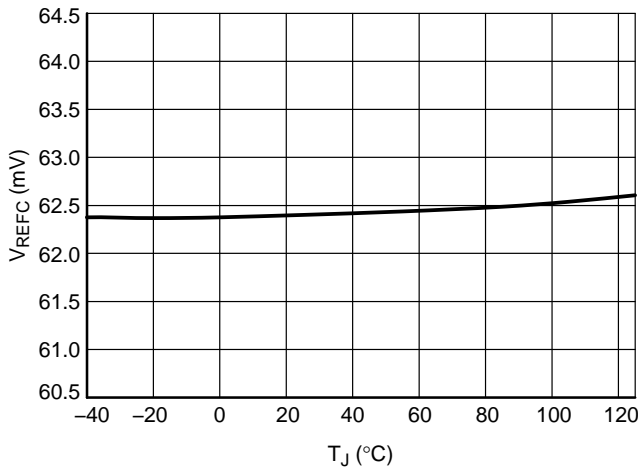

Figure 4. V_{REFC} at V_{CC} = 15 V

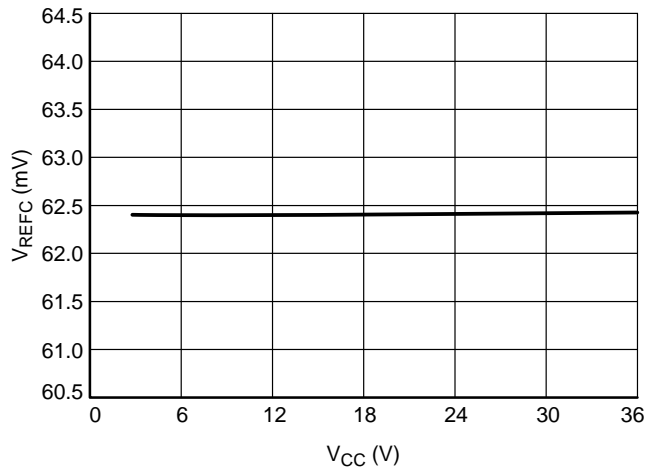

Figure 5. V_{REFC} at T_J = 25°C

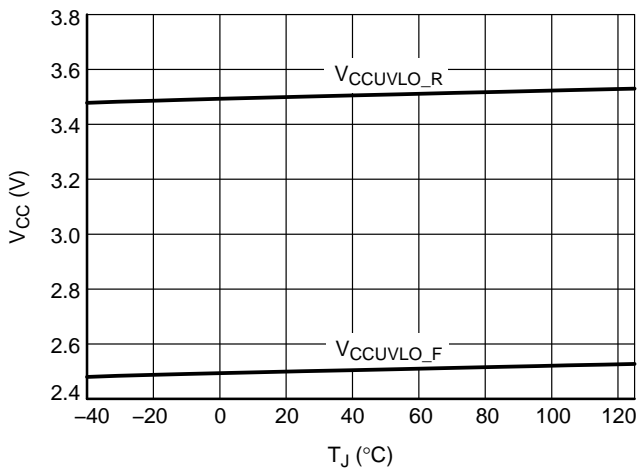

Figure 6. V_{CCUVLO} Rise and Fall Threshold

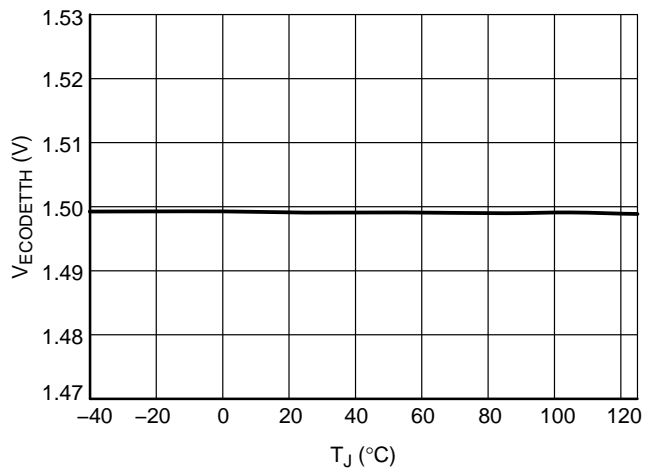

Figure 7. V_{ECODETTH} at V_{CC} = 15 V

TYPICAL CHARACTERISTICS

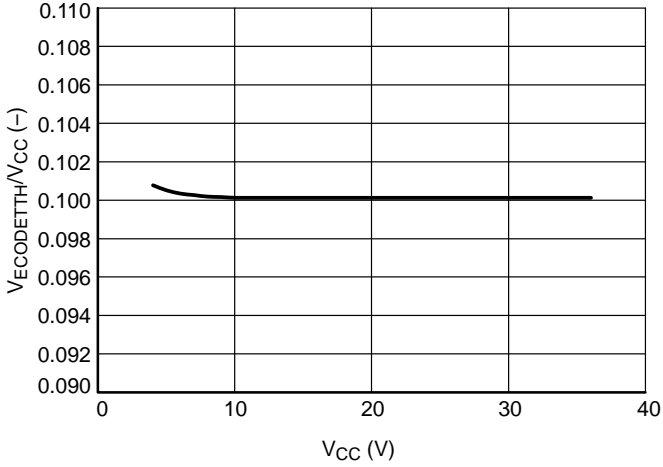

Figure 8. V_{ECDETH}/V_{CC} Ratio at T_J = 25°C

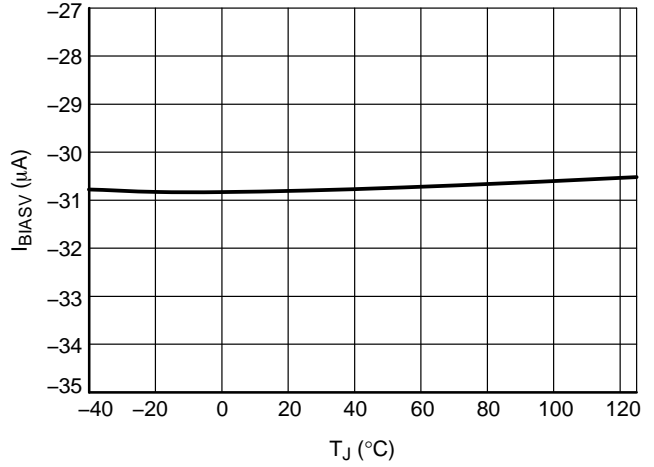

Figure 9. I_{BIASV} at V_{CC} = 15 V, V_{SNS} > V_{SNSBIASLTH}, V_{ECDETH} < 10% V_{CC}

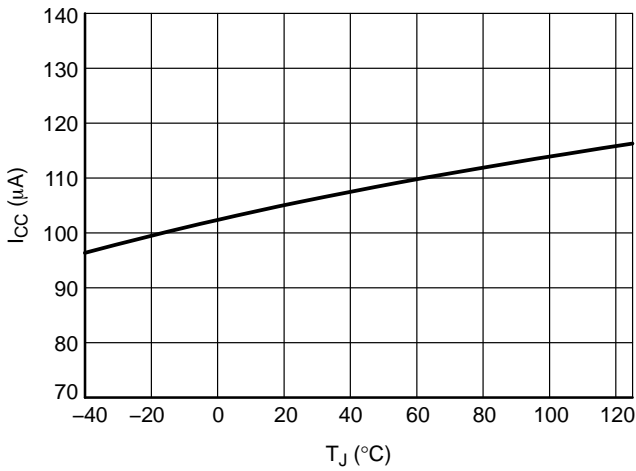

Figure 10. I_{CC} in Regulation, V_{CC} = 15 V, V_{ECDETH} = 2 V

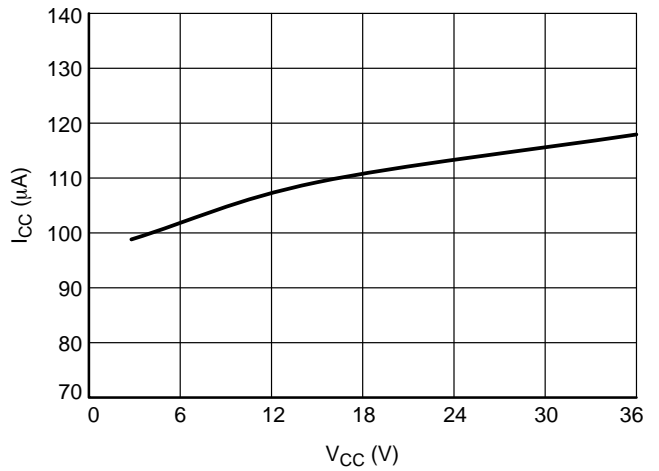

Figure 11. I_{CC} in Regulation, T_J = 25°C, V_{ECDETH} > 10% V_{CC}

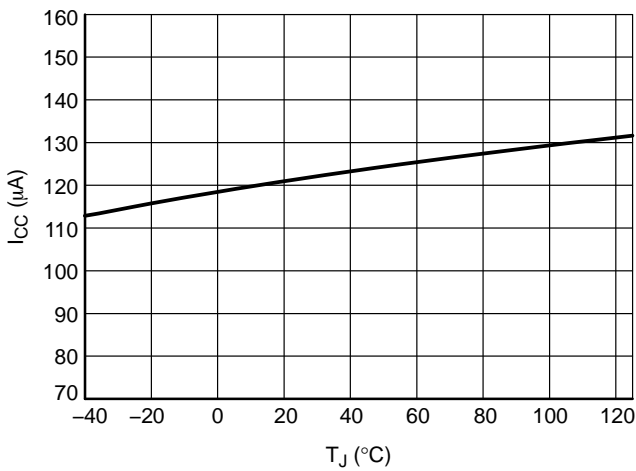

Figure 12. I_{CC} in ECO Mode, V_{CC} = 15 V, V_{ECDETH} = 1 V, V_{SNS} = V_{REF}

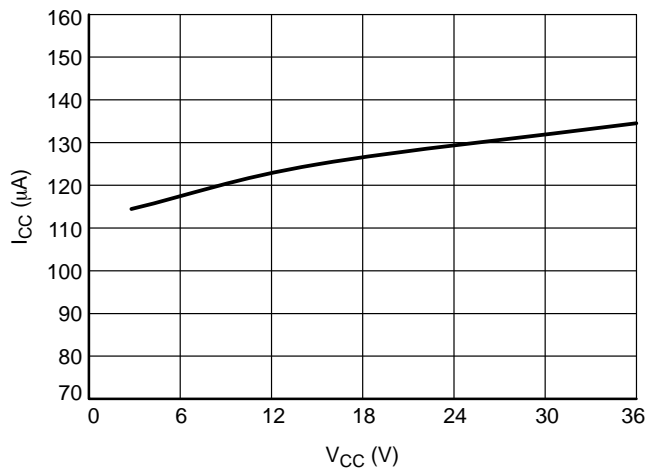

Figure 13. I_{CC} in ECO Mode, T_J = 25°C, V_{ECDETH} = 1 V, V_{SNS} = V_{REF}

NCP4352

TYPICAL CHARACTERISTICS

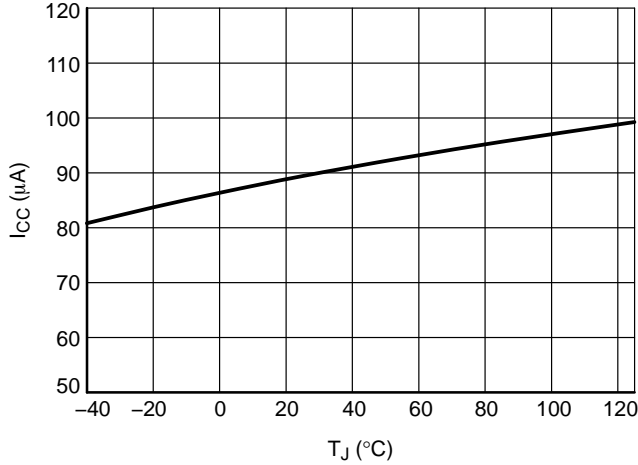

Figure 14. I_{CC} in ECO Mode, $V_{CC} = 15$ V, $V_{ECODET} = 0$ V, $V_{SNS} < V_{SNSBIAS}$

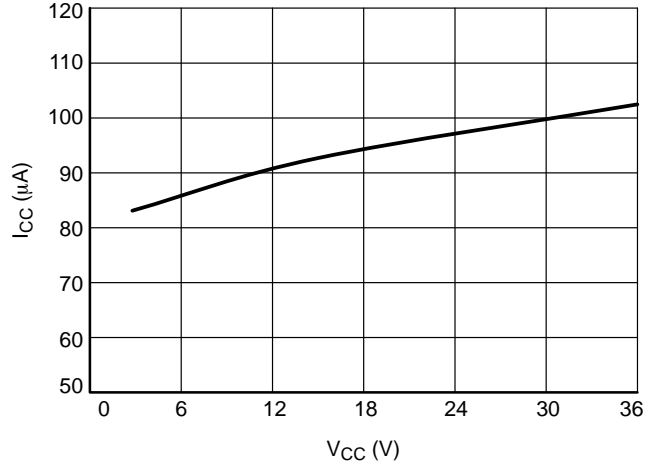

Figure 15. I_{CC} in ECO Mode, $T_J = 25^\circ\text{C}$, $V_{ECODET} = 1$ V, $V_{SNS} < V_{SNSBIAS}$

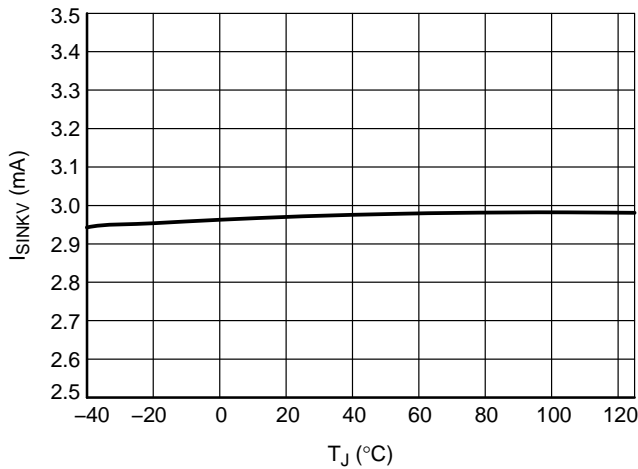

Figure 16. Voltage OTA Current Sink Capability in Normal Mode, $V_{CC} = 15$ V, $V_{ECODET} = 2$ V

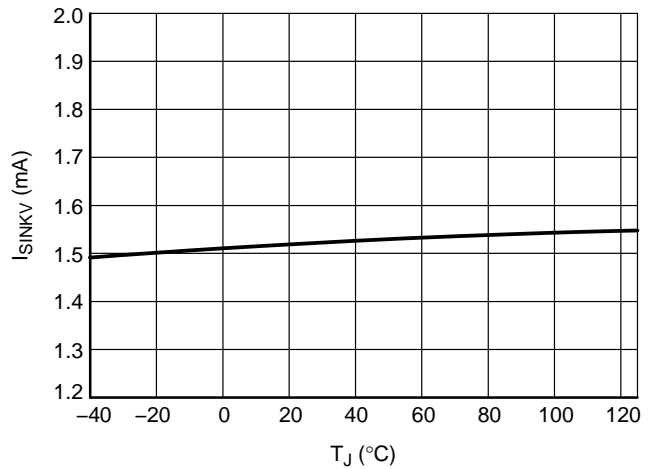

Figure 17. Voltage OTA Current Sink Capability in ECO Mode, $V_{CC} = 15$ V, $V_{ECODET} = 1$ V

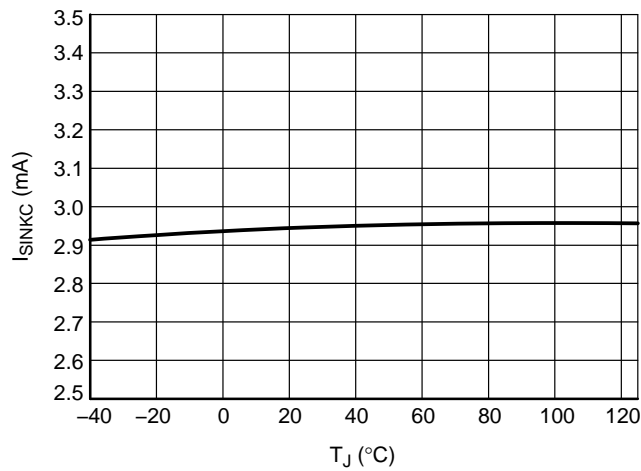

Figure 18. Current OTA Current Sink Capability in Normal Mode, $V_{CC} = 15$ V, $V_{ECODET} = 2$ V

APPLICATION INFORMATION

A typical application circuits for NCP4352 series is shown in Figure 19. Pin functions are available in pin description table.

Figure 20 shows possible connection to flyback primary controller. This schematic uses one single optocoupler for both voltage and current regulation functions.

Those schematics provide all possible functionalities.

Power Supply

The NCP4352 is designed to operate from a single supply up to 36 V. It starts to operate when VCC voltage reaches 3.5 V and stops when VCC voltage drops below 2.5 V. VCC can be supplied by direct connection to the VOUT voltage of the power supply. It is recommended to add a RC filter (R1 and C3) in series from VOUT to VCC pin to reduce voltage spikes and drops that are produced at the converter’s output capacitors. Recommended values for this filter are 220 Ω and 1 μF.

Voltage Regulation Path

The output voltage is detected on the VSNS pin by the R3 and R4 voltage divider. This voltage is compared with the internal precise voltage reference. The voltage difference is amplified by gm_V of the transconductance amplifier. The amplifier output current is connected to the FBC pin. The compensation network is also connected to this pin to provide frequency compensation for the voltage regulation path. This FBC pin drives an optocoupler to prove the secondary side regulation. The optocoupler is supplied via direct connection to VOUT line through resistor R1.

Regulation information is transferred through the optocoupler to the primary side controller where its FB pin is usually pulled down to reduce energy transferred to secondary output.

The output voltage can be computed by Equation 1.

$$V_{OUT} = V_{REF} \frac{R3 + R4}{R4} \quad (\text{eq. 1})$$

Current Regulation Path

The output current is sensed by the shut resistor R11 in series with the load. Voltage drop on R11 is compared with internal precise voltage reference V_{REFC} at ISNS transconductance amplifier input.

Voltage difference is amplified by gm_C to output current of amplifier, connected to FBC pin. Compensation network is connected between this pin and ISNS input to provide frequency compensation for current regulation path.

Current regulation OTA is activated only in normal mode, during ECO mode is turned-off to save energy. It doesn’t make any issue, because ECO mode is activated just in case of light load so current regulation path is not needed.

Current regulation point is set to current given by Equation 2.

$$I_{OUTLIM} = \frac{V_{REFC}}{R11} \quad (\text{eq. 2})$$

ECO Mode Detection

ECO mode operation is advantageous for ultra low output current condition. The reduced output voltage with very long skip off time and the low power mode of the whole regulation system reduces strongly the overall consumption.

The output voltage is reduced to a second regulation point in ECO mode. When output voltage decreases, the overall output and regulation power are reduced.

The ECO mode detection is based on comparison of output voltage and voltage loaded with fixed resistances (D2, R6, R7, R8 and C2).

Figure 21 shows detection waveforms. When output voltage is loaded with very low current, primary controller goes into skip mode (primary controller stops switching for some time). While output power is reduced, thanks to the serial resistance R6, the voltage on capacitor C2 provides a voltage proportional to output power, allowing power level detection.

Ones ECODET pin voltage goes lower than V_{ECODETTH} (this threshold is derived from V_{OUT} = V_{CC}), ECO mode is detected. This means that ECO mode is not activated until falling edge comes at ECODET pin.

To reduce output voltage on C1 down to the new regulation point, the current I_{BIASV} injected into VSNS pin provides the requested offset (VSNS voltage is higher than V_{REF}). This offset, defined by R4, R5 and the internal current source, allows keeping the same output voltage resistances divider defined for the normal mode. Reduced output voltage in ECO mode can be computed by Equation 3.

$$I_{R3} = \frac{V_{REF} + (R4 + R5) \cdot I_{BIASV}}{R4} \quad (\text{eq. 3})$$

$$V_{OUT_ECO} = I_{R3} \cdot R3 + (I_{R3} - I_{BIASV}) \cdot R4$$

The sink current on primary FB pin is so adjusted to keep primary controller FB in line with the new working point with reduced output voltage.

Primary IC should be kept supplied from auxiliary winding of the transformer despite overall voltage reduction. This may ask for serial voltage regulator to avoid over voltage in normal mode.

If output power increases such that ECODET pin voltage is higher than 10% of V_{CC}, the ECO mode is ended and regulation is switched back to original normal mode. The IC also starts in normal mode after UVLO event.

NCP4352

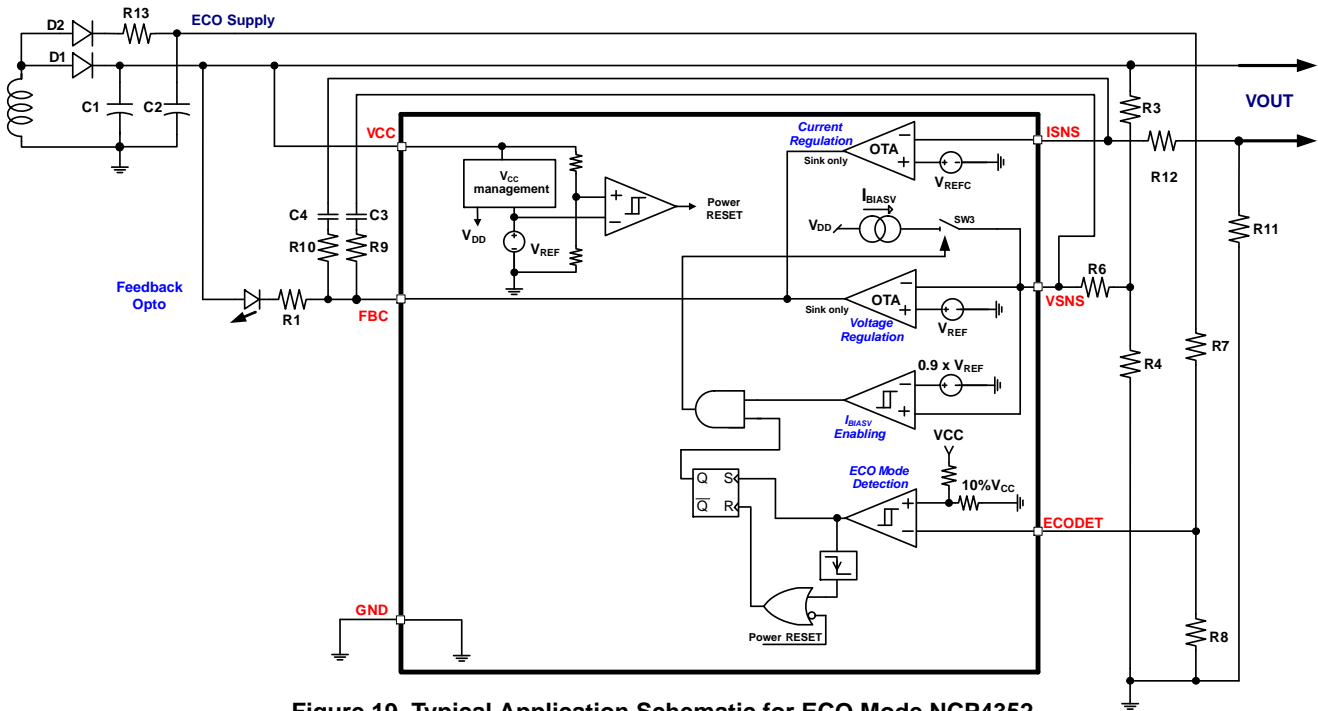

Figure 19. Typical Application Schematic for ECO Mode NCP4352

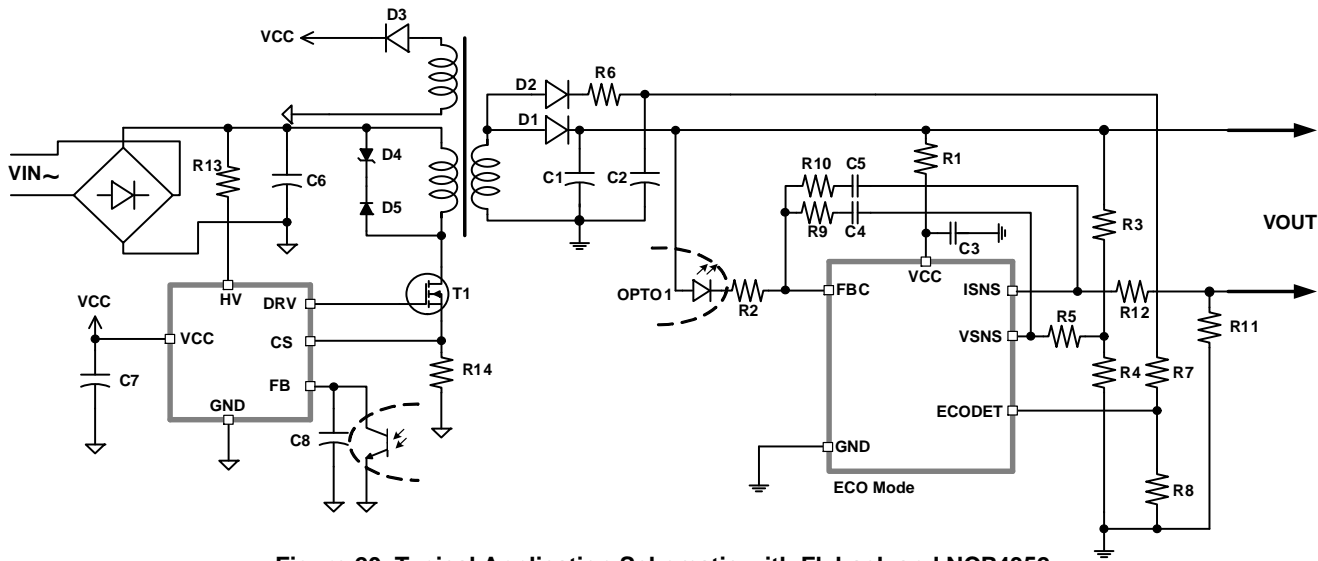

Figure 20. Typical Application Schematic with Flyback and NCP4352

NCP4352

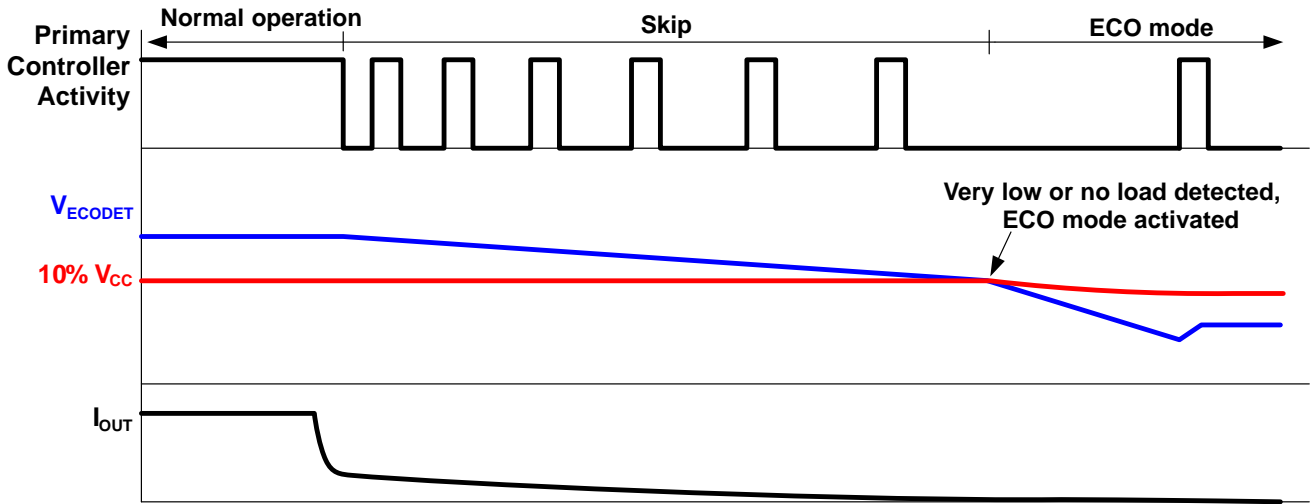

Figure 21. ECO Mode Detection

ORDERING INFORMATION

Device	Marking	Package	Shipping [†]
NCP4352SNT1G	E52	TSOP-6 (Pb-Free)	3000 / Tape & Reel

[†]For information on tape and reel specifications, including part orientation and tape sizes, please refer to our Tape and Reel Packaging Specifications Brochure, BRD8011/D.

MECHANICAL CASE OUTLINE

PACKAGE DIMENSIONS

ON Semiconductor®



SCALE 2:1

TSOP-6 CASE 318G-02 ISSUE V

DATE 12 JUN 2012

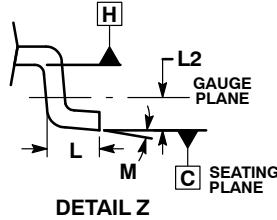
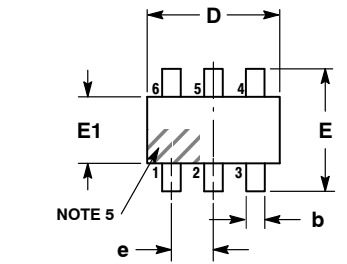

NOTES:

1. DIMENSIONING AND TOLERANCING PER ASME Y14.5M, 1994.
2. CONTROLLING DIMENSION: MILLIMETERS.
3. MAXIMUM LEAD THICKNESS INCLUDES LEAD FINISH. MINIMUM LEAD THICKNESS IS THE MINIMUM THICKNESS OF BASE MATERIAL.
4. DIMENSIONS D AND E1 DO NOT INCLUDE MOLD FLASH, PROTRUSIONS, OR GATE BURRS. MOLD FLASH, PROTRUSIONS, OR GATE BURRS SHALL NOT EXCEED 0.15 PER SIDE. DIMENSIONS D AND E1 ARE DETERMINED AT DATUM H.
5. PIN ONE INDICATOR MUST BE LOCATED IN THE INDICATED ZONE.

DIM	MILLIMETERS		
	MIN	NOM	MAX
A	0.90	1.00	1.10
A1	0.01	0.06	0.10
b	0.25	0.38	0.50
c	0.10	0.18	0.26
D	2.90	3.00	3.10
E	2.50	2.75	3.00
E1	1.30	1.50	1.70
e	0.85	0.95	1.05
L	0.20	0.40	0.60
L2	0.25 BSC		
M	0°	-	10°

- | | | | | | |
|--|--|---|---|---|--|
| <p>STYLE 1:
PIN 1. DRAIN
2. DRAIN
3. GATE
4. SOURCE
5. DRAIN
6. DRAIN</p> | <p>STYLE 2:
PIN 1. EMITTER 2
2. BASE 1
3. COLLECTOR 1
4. EMITTER 1
5. BASE 2
6. COLLECTOR 2</p> | <p>STYLE 3:
PIN 1. ENABLE
2. N/C
3. R BOOST
4. Vz
5. V in
6. V out</p> | <p>STYLE 4:
PIN 1. N/C
2. V in
3. NOT USED
4. GROUND
5. ENABLE
6. LOAD</p> | <p>STYLE 5:
PIN 1. EMITTER 2
2. BASE 2
3. COLLECTOR 1
4. EMITTER 1
5. BASE 1
6. COLLECTOR 2</p> | <p>STYLE 6:
PIN 1. COLLECTOR
2. COLLECTOR
3. BASE
4. EMITTER
5. COLLECTOR
6. COLLECTOR</p> |
| <p>STYLE 7:
PIN 1. COLLECTOR
2. COLLECTOR
3. BASE
4. N/C
5. COLLECTOR
6. EMITTER</p> | <p>STYLE 8:
PIN 1. Vbus
2. D(in)
3. D(in)+
4. D(out)+
5. D(out)
6. GND</p> | <p>STYLE 9:
PIN 1. LOW VOLTAGE GATE
2. DRAIN
3. SOURCE
4. DRAIN
5. DRAIN
6. HIGH VOLTAGE GATE</p> | <p>STYLE 10:
PIN 1. D(OUT)+
2. GND
3. D(OUT)-
4. D(IN)-
5. VBUS
6. D(IN)+</p> | <p>STYLE 11:
PIN 1. SOURCE 1
2. DRAIN 2
3. DRAIN 2
4. SOURCE 2
5. GATE 1
6. DRAIN 1/GATE 2</p> | <p>STYLE 12:
PIN 1. I/O
2. GROUND
3. I/O
4. I/O
5. VCC
6. I/O</p> |
| <p>STYLE 13:
PIN 1. GATE 1
2. SOURCE 2
3. GATE 2
4. DRAIN 2
5. SOURCE 1
6. DRAIN 1</p> | <p>STYLE 14:
PIN 1. ANODE
2. SOURCE
3. GATE
4. CATHODE/DRAIN
5. CATHODE/DRAIN
6. CATHODE/DRAIN</p> | <p>STYLE 15:
PIN 1. ANODE
2. SOURCE
3. GATE
4. DRAIN
5. N/C
6. CATHODE</p> | <p>STYLE 16:
PIN 1. ANODE/CATHODE
2. BASE
3. EMITTER
4. COLLECTOR
5. ANODE
6. CATHODE</p> | <p>STYLE 17:
PIN 1. EMITTER
2. BASE
3. ANODE/CATHODE
4. ANODE
5. CATHODE
6. COLLECTOR</p> | |

RECOMMENDED SOLDERING FOOTPRINT*



DIMENSIONS: MILLIMETERS

GENERIC MARKING DIAGRAM*



- | | |
|--|---|
| <p>XXX = Specific Device Code
A = Assembly Location
Y = Year
W = Work Week
▪ = Pb-Free Package</p> | <p>XXX = Specific Device Code
M = Date Code
▪ = Pb-Free Package</p> |
|--|---|

*For additional information on our Pb-Free strategy and soldering details, please download the ON Semiconductor Soldering and Mounting Techniques Reference Manual, SOLDERRM/D.

*This information is generic. Please refer to device data sheet for actual part marking. Pb-Free indicator, "G" or microdot "▪", may or may not be present.

DOCUMENT NUMBER:	98ASB14888C	Electronic versions are uncontrolled except when accessed directly from the Document Repository. Printed versions are uncontrolled except when stamped "CONTROLLED COPY" in red.
DESCRIPTION:	TSOP-6	PAGE 1 OF 1

ON Semiconductor and ON are trademarks of Semiconductor Components Industries, LLC dba ON Semiconductor or its subsidiaries in the United States and/or other countries. ON Semiconductor reserves the right to make changes without further notice to any products herein. ON Semiconductor makes no warranty, representation or guarantee regarding the suitability of its products for any particular purpose, nor does ON Semiconductor assume any liability arising out of the application or use of any product or circuit, and specifically disclaims any and all liability, including without limitation special, consequential or incidental damages. ON Semiconductor does not convey any license under its patent rights nor the rights of others.

ON Semiconductor and  are trademarks of Semiconductor Components Industries, LLC dba ON Semiconductor or its subsidiaries in the United States and/or other countries. ON Semiconductor owns the rights to a number of patents, trademarks, copyrights, trade secrets, and other intellectual property. A listing of ON Semiconductor's product/patent coverage may be accessed at www.onsemi.com/site/pdf/Patent-Marking.pdf. ON Semiconductor reserves the right to make changes without further notice to any products herein. ON Semiconductor makes no warranty, representation or guarantee regarding the suitability of its products for any particular purpose, nor does ON Semiconductor assume any liability arising out of the application or use of any product or circuit, and specifically disclaims any and all liability, including without limitation special, consequential or incidental damages. Buyer is responsible for its products and applications using ON Semiconductor products, including compliance with all laws, regulations and safety requirements or standards, regardless of any support or applications information provided by ON Semiconductor. "Typical" parameters which may be provided in ON Semiconductor data sheets and/or specifications can and do vary in different applications and actual performance may vary over time. All operating parameters, including "Typicals" must be validated for each customer application by customer's technical experts. ON Semiconductor does not convey any license under its patent rights nor the rights of others. ON Semiconductor products are not designed, intended, or authorized for use as a critical component in life support systems or any FDA Class 3 medical devices or medical devices with a same or similar classification in a foreign jurisdiction or any devices intended for implantation in the human body. Should Buyer purchase or use ON Semiconductor products for any such unintended or unauthorized application, Buyer shall indemnify and hold ON Semiconductor and its officers, employees, subsidiaries, affiliates, and distributors harmless against all claims, costs, damages, and expenses, and reasonable attorney fees arising out of, directly or indirectly, any claim of personal injury or death associated with such unintended or unauthorized use, even if such claim alleges that ON Semiconductor was negligent regarding the design or manufacture of the part. ON Semiconductor is an Equal Opportunity/Affirmative Action Employer. This literature is subject to all applicable copyright laws and is not for resale in any manner.

PUBLICATION ORDERING INFORMATION

LITERATURE FULFILLMENT:

Email Requests to: orderlit@onsemi.com

ON Semiconductor Website: www.onsemi.com

TECHNICAL SUPPORT

North American Technical Support:
Voice Mail: 1 800-282-9855 Toll Free USA/Canada
Phone: 011 421 33 790 2910

Europe, Middle East and Africa Technical Support:

Phone: 00421 33 790 2910

For additional information, please contact your local Sales Representative