

## HIGH AND LOW SIDE DRIVER

### Features

- Floating channel designed for bootstrap operation
- Fully operational to +500 V or +600 V
- Tolerant to negative transient voltage, dV/dt immune
- Gate drive supply range from 10 V to 20 V
- Undervoltage lockout for both channels
- 3.3 V logic compatible
- Separate logic supply range from 3.3 V to 20 V
- Logic and power ground  $\pm 5V$  offset
- CMOS Schmitt-triggered inputs with pull-down
- Cycle by cycle edge-triggered shutdown logic
- Matched propagation delay for both channels
- Outputs in phase with inputs
- RoHS compliant

### Description

The IRS2110/IRS2113 are high voltage, high speed power MOSFET and IGBT drivers with independent high-side and low-side referenced output channels. Proprietary HVIC and latch immune CMOS technologies enable ruggedized monolithic construction. Logic inputs are compatible with standard CMOS or LSTTL output, down to 3.3 V logic. The output drivers feature a high pulse current buffer stage designed for minimum driver cross-conduction. Propagation delays are matched to simplify use in high frequency applications. The floating channel can be used to drive an N-channel power MOSFET or IGBT in the high-side configuration which operates up to 500 V or 600 V.

### Product Summary

|                               |                 |
|-------------------------------|-----------------|
| V <sub>OFFSET</sub> (IRS2110) | 500 V max.      |
| (IRS2113)                     | 600 V max.      |
| I <sub>O+/-</sub>             | 2 A/2 A         |
| V <sub>OUT</sub>              | 10 V - 20 V     |
| t <sub>on/off</sub> (typ.)    | 130 ns & 120 ns |
| Delay Matching (IRS2110)      | 10 ns max.      |
| (IRS2113)                     | 20 ns max.      |

### Packages

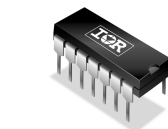

14-Lead PDIP  
IRS2110 and IRS2113

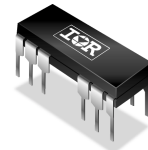

16-Lead PDIP  
(w/o leads 4 & 5)  
IRS2110-2 and IRS2113-2



14-Lead PDIP  
(w/o lead 4)  
IRS2110-1 and IRS2113-1



16-Lead SOIC  
IRS2110S and  
IRS2113S

### Typical Connection

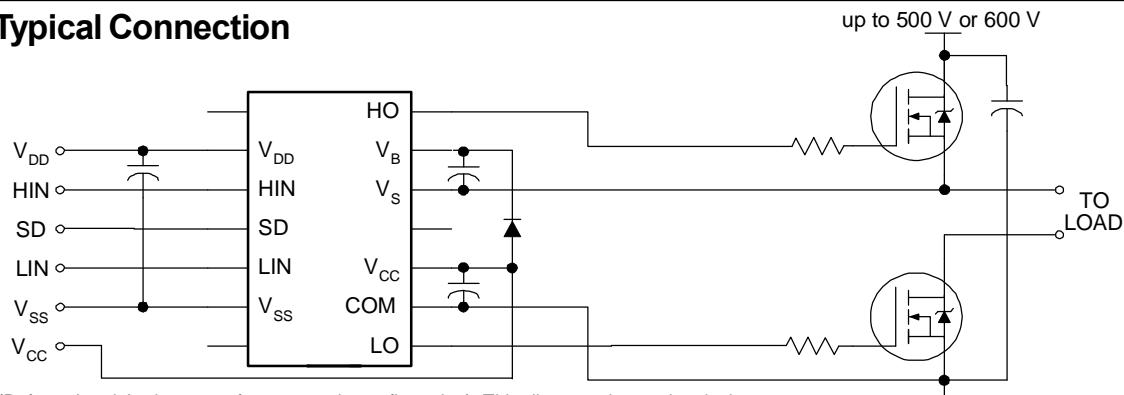

(Refer to Lead Assignments for correct pin configuration). This diagram shows electrical connections only. Please refer to our Application Notes and DesignTips for proper circuit board layout.

## Absolute Maximum Ratings

Absolute maximum ratings indicate sustained limits beyond which damage to the device may occur. All voltage parameters are absolute voltages referenced to COM. The thermal resistance and power dissipation ratings are measured under board mounted and still air conditions. Additional information is shown in Figs. 28 through 35.

| Symbol              | Definition  |                | Min.                  | Max.                            | Units |
|---------------------|---|----------------|-----------------------|---------------------------------|-------|
| V <sub>B</sub>      | High-side floating supply voltage                   | (IRS2110)      | -0.3                  | 520 (Note 1)                    | V     |
|                     |   | (IRS2113)      | -0.3                  | 620 (Note 1)                    |       |
| V <sub>S</sub>      | High-side floating supply offset voltage            |                | V <sub>B</sub> - 20   | V <sub>B</sub> + 0.3            |       |
| V <sub>HO</sub>     | High-side floating output voltage                   |                | V <sub>S</sub> - 0.3  | V <sub>B</sub> + 0.3            |       |
| V <sub>CC</sub>     | Low-side fixed supply voltage                       |                | -0.3                  | 20 (Note 1)                     |       |
| V <sub>LO</sub>     | Low-side output voltage                             |                | -0.3                  | V <sub>CC</sub> + 0.3           |       |
| V <sub>DD</sub>     | Logic supply voltage                                |                | -0.3                  | V <sub>SS</sub> +20<br>(Note 1) |       |
| V <sub>SS</sub>     | Logic supply offset voltage                         |                | V <sub>CC</sub> - 20  | V <sub>CC</sub> + 0.3           |       |
| V <sub>IN</sub>     | Logic input voltage (HIN, LIN, & SD)                |                | V <sub>SS</sub> - 0.3 | V <sub>DD</sub> + 0.3           |       |
| dV <sub>S</sub> /dt | Allowable offset supply voltage transient (Fig. 2)  |                | —                     | 50                              |       |
| PD                  | Package power dissipation @ T <sub>A</sub> ≤ +25 °C | (14 lead DIP)  | —                     | 1.6                             | W     |
|                     |   | (16 lead SOIC) | —                     | 1.25                            |       |
| R <sub>THJA</sub>   | Thermal resistance, junction to ambient             | (14 lead DIP)  | —                     | 75                              | °C/W  |
|                     |   | (16 lead SOIC) | —                     | 100                             |       |
| T <sub>J</sub>      | Junction temperature                                |                | —                     | 150                             | °C    |
| T <sub>S</sub>      | Storage temperature                                 |                | -55                   | 150                             |       |
| T <sub>L</sub>      | Lead temperature (soldering, 10 seconds)            |                | —                     | 300                             |       |

Note 1: All supplies are fully tested at 25 V, and an internal 20 V clamp exists for each supply.

## Recommended Operating Conditions

The input/output logic timing diagram is shown in Fig. 1. For proper operation, the device should be used within the recommended conditions. The V<sub>S</sub> and V<sub>SS</sub> offset ratings are tested with all supplies biased at a 15 V differential. Typical ratings at other bias conditions are shown in Figs. 36 and 37.

| Symbol          | Definition                                 |           | Min.                | Max.                 | Units |
|-----------------|--|-----------|---------------------|----------------------|-------|
| V <sub>B</sub>  | High-side floating supply absolute voltage |           | V <sub>S</sub> + 10 | V <sub>S</sub> + 20  | V     |
| V <sub>S</sub>  | High-side floating supply offset voltage   | (IRS2110) | Note 2              | 500                  |       |
|                 |  | (IRS2113) | Note 2              | 600                  |       |
| V <sub>HO</sub> | High-side floating output voltage          |           | V <sub>S</sub>      | V <sub>B</sub>       |       |
| V <sub>CC</sub> | Low-side fixed supply voltage              |           | 10                  | 20                   |       |
| V <sub>LO</sub> | Low-side output voltage                    |           | 0                   | V <sub>CC</sub>      |       |
| V <sub>DD</sub> | Logic supply voltage                       |           | V <sub>SS</sub> + 3 | V <sub>SS</sub> + 20 |       |
| V <sub>SS</sub> | Logic supply offset voltage                |           | -5 (Note 3)         | 5                    |       |
| V <sub>IN</sub> | Logic input voltage (HIN, LIN & SD)        |           | V <sub>SS</sub>     | V <sub>DD</sub>      |       |
| T <sub>A</sub>  | Ambient temperature                        |           | -40                 | 125                  | °C    |

Note 2: Logic operational for V<sub>S</sub> of -4 V to +500 V. Logic state held for V<sub>S</sub> of -4 V to -V<sub>BS</sub>. (Refer to the Design Tip DT97-3)

Note 3: When V<sub>DD</sub> < 5 V, the minimum V<sub>SS</sub> offset is limited to -V<sub>DD</sub>.

## Dynamic Electrical Characteristics

$V_{BIAS}$  ( $V_{CC}$ ,  $V_{BS}$ ,  $V_{DD}$ ) = 15 V,  $C_L$  = 1000 pF,  $T_A$  = 25 °C and  $V_{SS}$  = COM unless otherwise specified. The dynamic electrical characteristics are measured using the test circuit shown in Fig. 3.

| Symbol    | Definition                          | Min.      | Typ. | Max. | Units | Test Conditions     |
|-----------|-------------------------------------|-----------|------|------|-------|---------------------|
| $t_{on}$  | Turn-on propagation delay           | —         | 130  | 160  | ns    | $V_S = 0$ V         |
| $t_{off}$ | Turn-off propagation delay          | —         | 120  | 150  |       | $V_S = 500$ V/600 V |
| $t_{sd}$  | Shutdown propagation delay          | —         | 130  | 160  |       |                     |
| $t_r$     | Turn-on rise time                   | —         | 25   | 35   |       |                     |
| $t_f$     | Turn-off fall time                  | —         | 17   | 25   |       |                     |
| MT        | Delay matching, HS & LS turn-on/off | (IRS2110) | —    | —    |       | 10                  |
|           |                                     | (IRS2113) | —    | —    | 20    |                     |

## Static Electrical Characteristics

$V_{BIAS}$  ( $V_{CC}$ ,  $V_{BS}$ ,  $V_{DD}$ ) = 15 V,  $T_A$  = 25 °C and  $V_{SS}$  = COM unless otherwise specified. The  $V_{IN}$ ,  $V_{TH}$ , and  $I_{IN}$  parameters are referenced to  $V_{SS}$  and are applicable to all three logic input leads: HIN, LIN, and SD. The  $V_O$  and  $I_O$  parameters are referenced to COM and are applicable to the respective output leads: HO or LO.

| Symbol      | Definition  | Min. | Typ. | Max. | Units          | Test Conditions  |
|-------------|---|------|------|------|----------------|--|
| $V_{IH}$    | Logic "1" input voltage                               | 9.5  | —    | —    | V              |  |
| $V_{IL}$    | Logic "0" input voltage                               | —    | —    | 6.0  |                |  |
| $V_{OH}$    | High level output voltage, $V_{BIAS} - V_O$           | —    | —    | 1.4  |                | $I_O = 0$ A  |
| $V_{OL}$    | Low level output voltage, $V_O$                       | —    | —    | 0.15 |                | $I_O = 20$ mA  |
| $I_{LK}$    | Offset supply leakage current                         | —    | —    | 50   | $\mu$ A        | $V_B = V_S = 500$ V/600 V                              |
| $I_{QBS}$   | Quiescent $V_{BS}$ supply current                     | —    | 125  | 230  |                | $V_{IN} = 0$ V or $V_{DD}$                             |
| $I_{QCC}$   | Quiescent $V_{CC}$ supply current                     | —    | 180  | 340  |                |  |
| $I_{QDD}$   | Quiescent $V_{DD}$ supply current                     | —    | 15   | 30   |                |  |
| $I_{IN+}$   | Logic "1" input bias current                          | —    | 20   | 40   |                | $V_{IN} = V_{DD}$                                      |
| $I_{IN-}$   | Logic "0" input bias current                          | —    | —    | 5.0  | $V_{IN} = 0$ V |  |
| $V_{BSUV+}$ | $V_{BS}$ supply undervoltage positive going threshold | 7.5  | 8.6  | 9.7  | V              |  |
| $V_{BSUV-}$ | $V_{BS}$ supply undervoltage negative going threshold | 7.0  | 8.2  | 9.4  |                |  |
| $V_{CCUV+}$ | $V_{CC}$ supply undervoltage positive going threshold | 7.4  | 8.5  | 9.6  |                |  |
| $V_{CCUV-}$ | $V_{CC}$ supply undervoltage negative going threshold | 7.0  | 8.2  | 9.4  |                |  |
| $I_{O+}$    | Output high short circuit pulsed current              | 2.0  | 2.5  | —    | A              | $V_O = 0$ V, $V_{IN} = V_{DD}$<br>$PW \leq 10$ $\mu$ s |
| $I_{O-}$    | Output low short circuit pulsed current               | 2.0  | 2.5  | —    |                | $V_O = 15$ V, $V_{IN} = 0$ V<br>$PW \leq 10$ $\mu$ s   |

### Functional Block Diagram

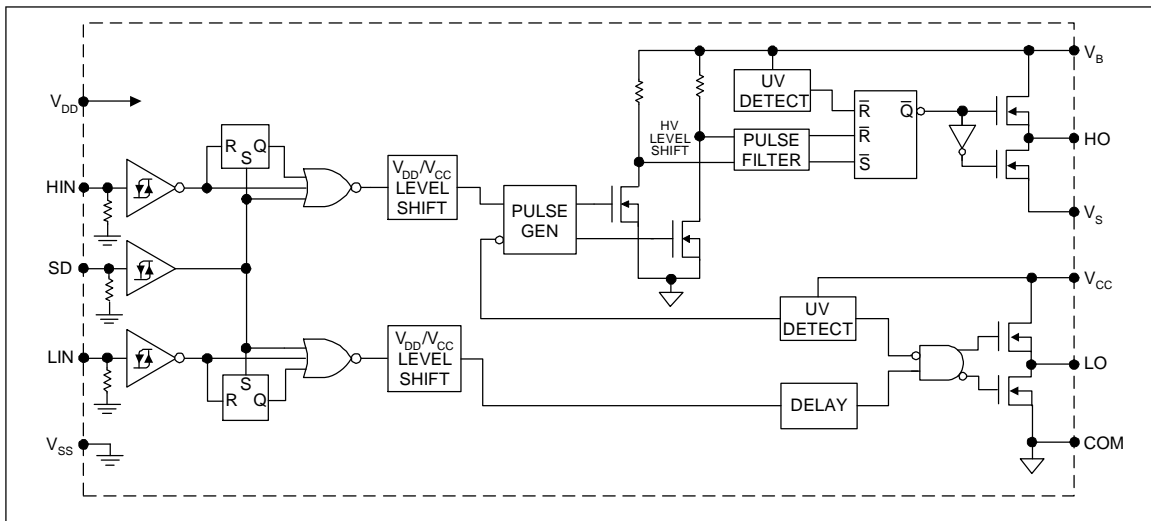

### Lead Definitions

| Symbol          | Description   |
|-----------------|---|
| V <sub>DD</sub> | Logic supply  |
| HIN             | Logic input for high-side gate driver output (HO), in phase |
| SD              | Logic input for shutdown                                    |
| LIN             | Logic input for low-side gate driver output (LO), in phase  |
| V <sub>SS</sub> | Logic ground  |
| V <sub>B</sub>  | High-side floating supply                                   |
| HO              | High-side gate drive output                                 |
| V <sub>S</sub>  | High-side floating supply return                            |
| V <sub>CC</sub> | Low-side supply   |
| LO              | Low-side gate drive output                                  |
| COM             | Low-side return   |

**Lead Assignments**

|   |  |
|---|--|
| <p style="text-align: center;">14 Lead PDIP<br/><b>IRS2110/IRS2113</b></p>                | <p style="text-align: center;">16 Lead SOIC (Wide Body)<br/><b>IRS2110S/IRS2113S</b></p>           |
| <p style="text-align: center;">14 Lead PDIP w/o lead 4<br/><b>IRS2110-1/IRS2113-1</b></p> | <p style="text-align: center;">16 Lead PDIP w/o leads 4 &amp; 5<br/><b>IRS2110-2/IRS2113-2</b></p> |
| <p><b>Part Number</b></p>   |  |

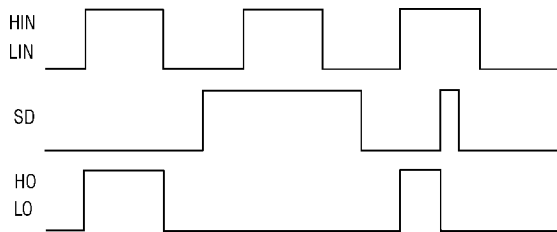

Figure 1. Input/Output Timing Diagram

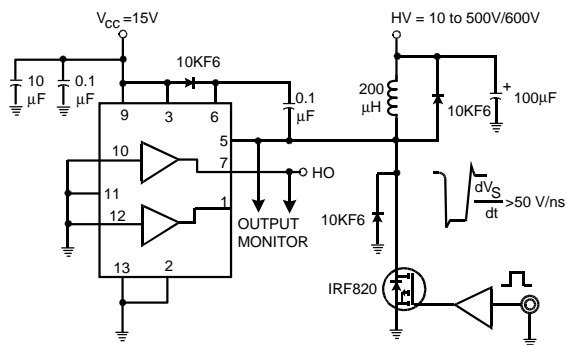

Figure 2. Floating Supply Voltage Transient Test Circuit

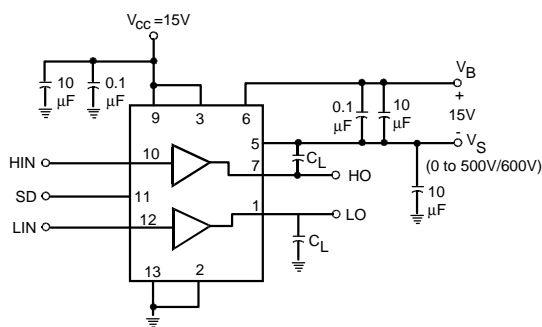

Figure 3. Switching Time Test Circuit

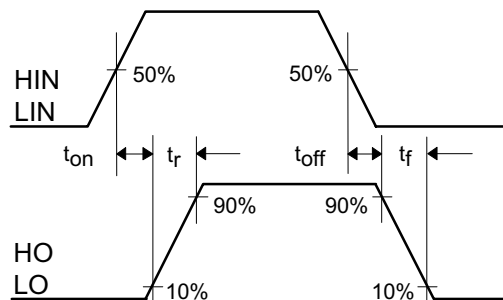

Figure 4. Switching Time Waveform Definition

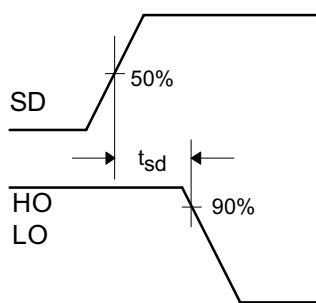

Figure 5. Shutdown Waveform Definitions

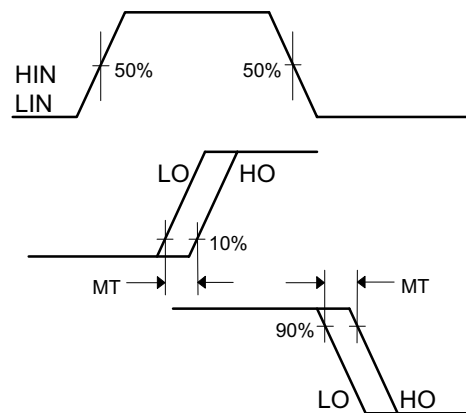

Figure 6. Delay Matching Waveform Definitions

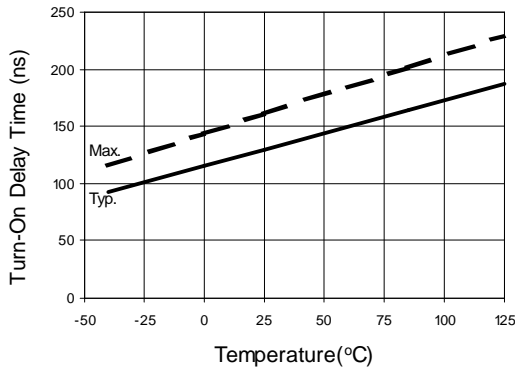

Figure 7A. Turn-On Time vs. Temperature

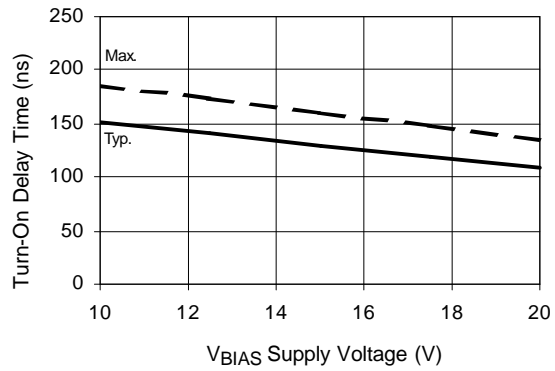

Figure 7B. Turn-On Time vs. Supply Voltage

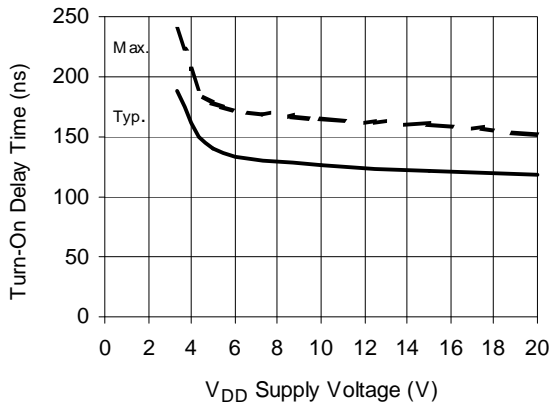

Figure 7C. Turn-On Time vs.  $V_{DD}$  Supply Voltage

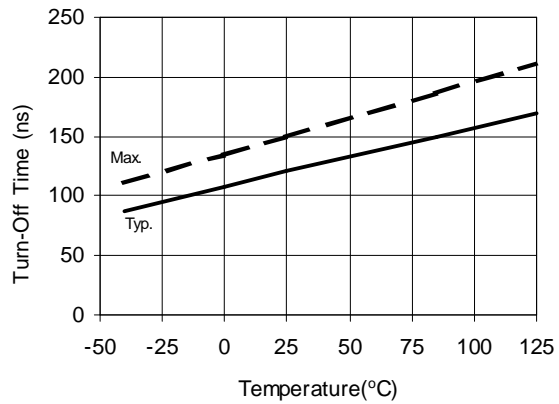

Figure 8A. Turn-Off Time vs. Temperature

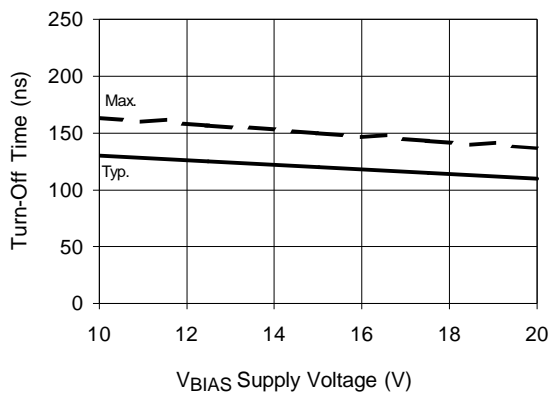

Figure 8B. Turn-Off Time vs. Supply Voltage

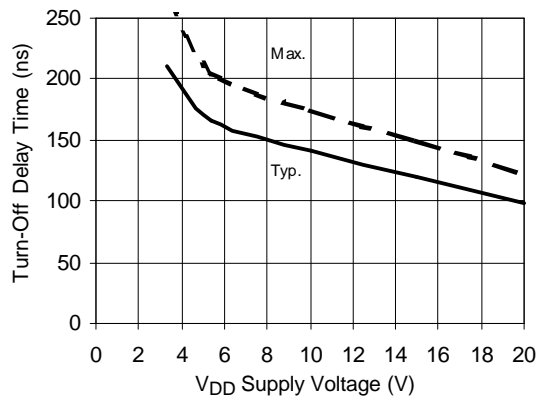

Figure 8C. Turn-Off Time vs.  $V_{DD}$  Supply Voltage

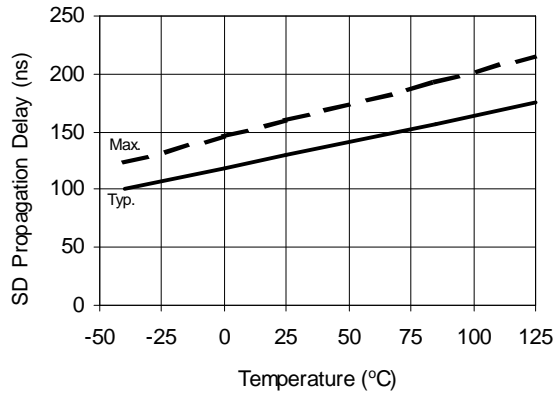

Figure 9A. Shutdown Time vs. Temperature

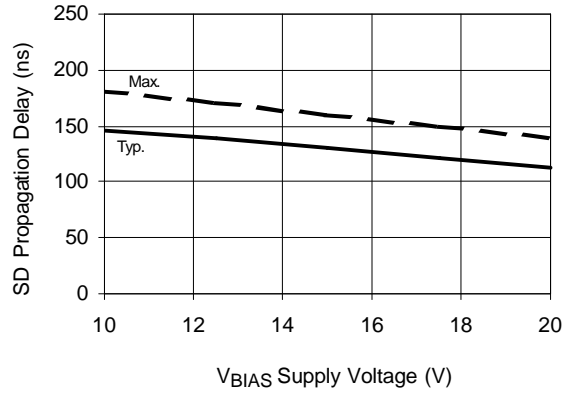

Figure 9B. Shutdown Time vs. Supply Voltage

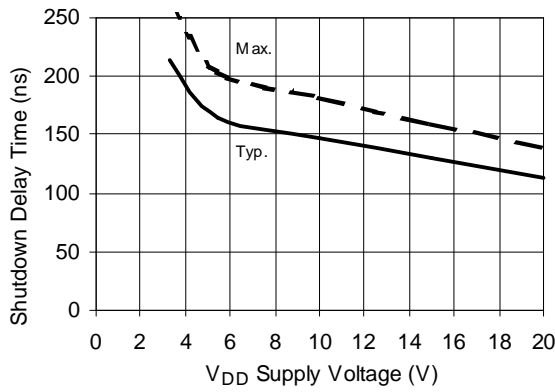

Figure 9C. Shutdown Time vs. VDD Supply Voltage

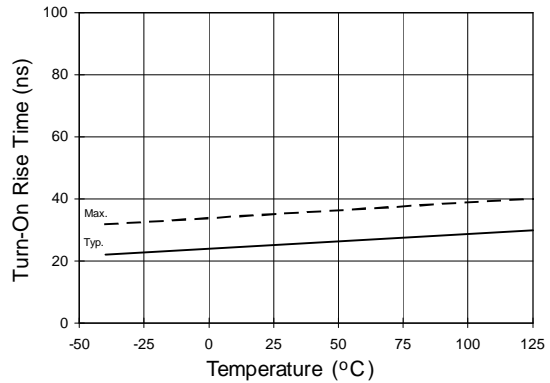

Figure 10A. Turn-On Rise Time vs. Temperature

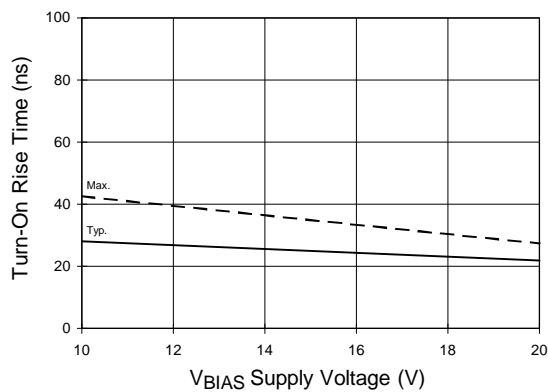

Figure 10B. Turn-On Rise Time vs. Voltage

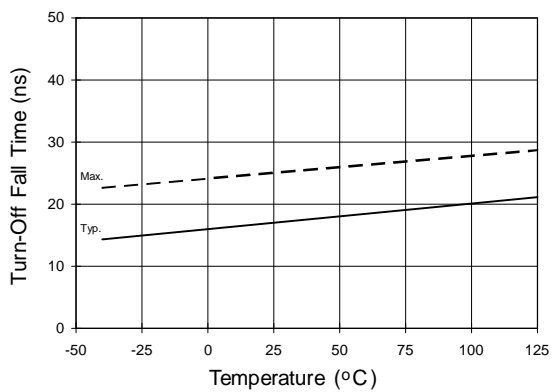

Figure 11A. Turn-Off Fall Time vs. Temperature



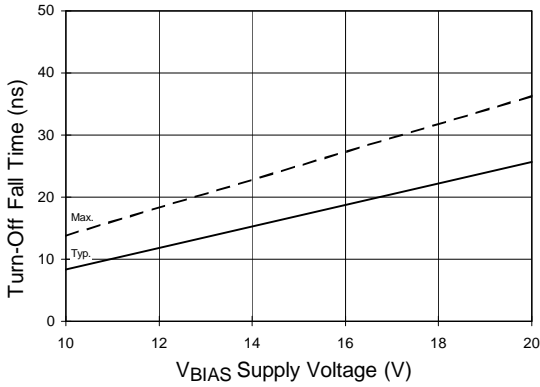

Figure 11B. Turn-Off Fall Time vs. Voltage

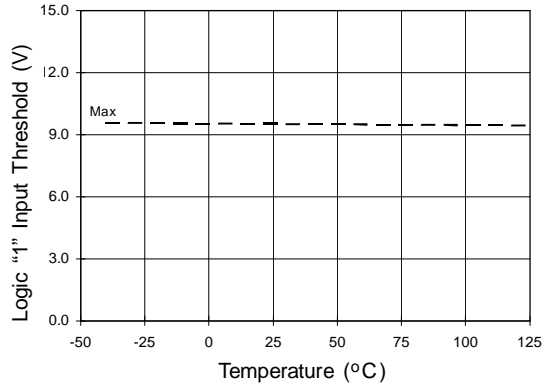

Figure 12A. Logic "1" Input Threshold vs. Temperature

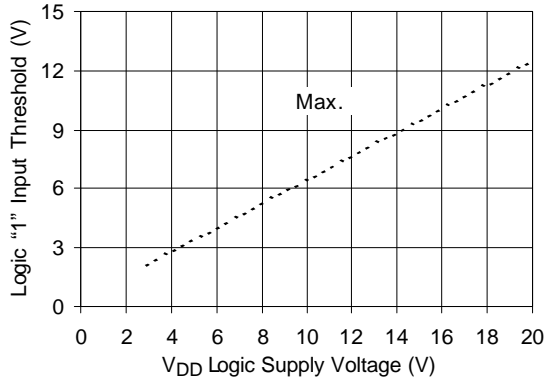

Figure 12B. Logic "1" Input Threshold vs. Voltage

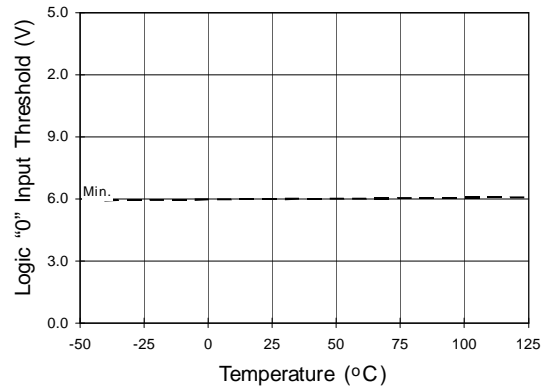

Figure 13A. Logic "0" Input Threshold vs. Temperature

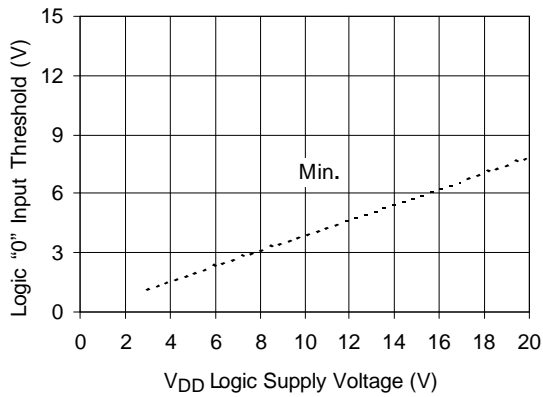

Figure 13B. Logic "0" Input Threshold vs. Voltage

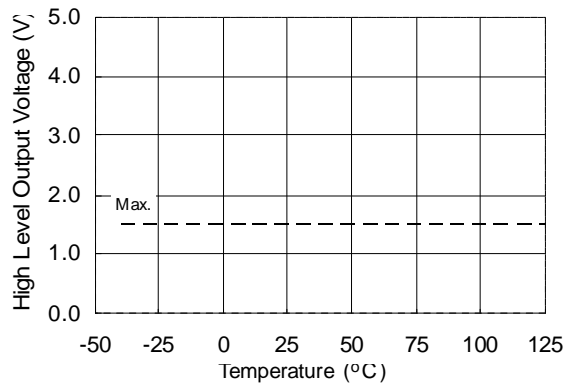

Figure 14A. High Level Output Voltage vs. Temperature ( $I_O = 0$  mA)

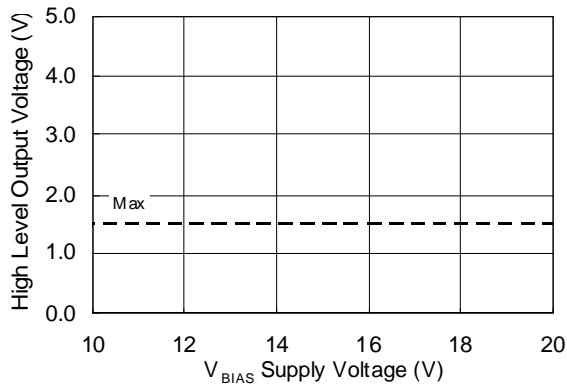

Figure 14B. High Level Output Voltage vs. Supply Voltage ( $I_o = 0$  mA)

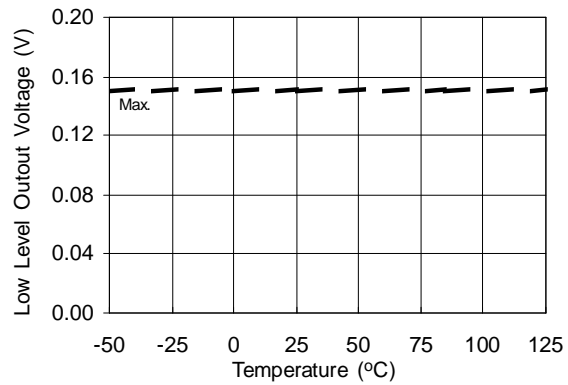

Figure 15A. Low Level Output vs. Temperature

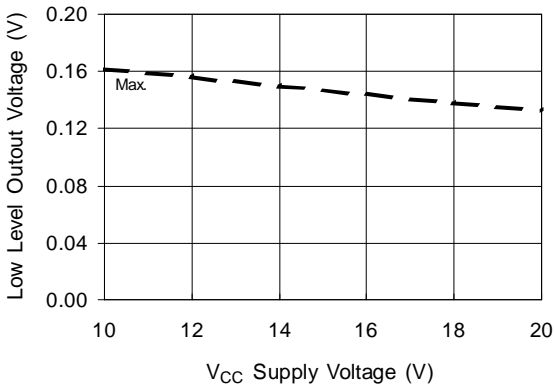

Figure 15B. Low Level Output vs. Supply Voltage

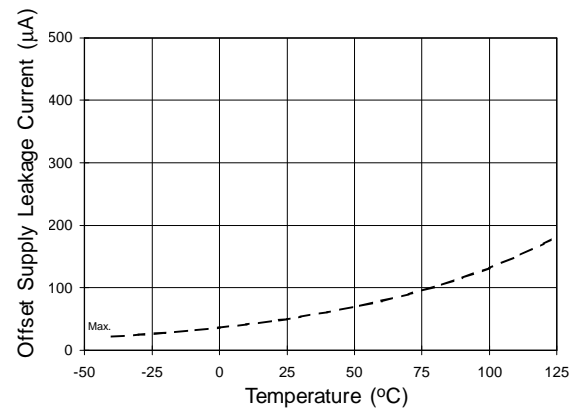

Figure 16A. Offset Supply Current vs. Temperature

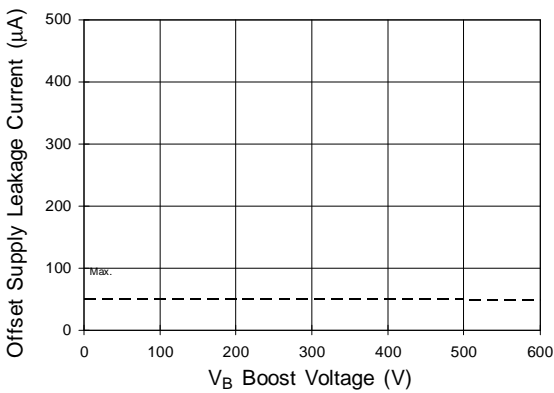

Figure 16B. Offset Supply Current vs. Voltage

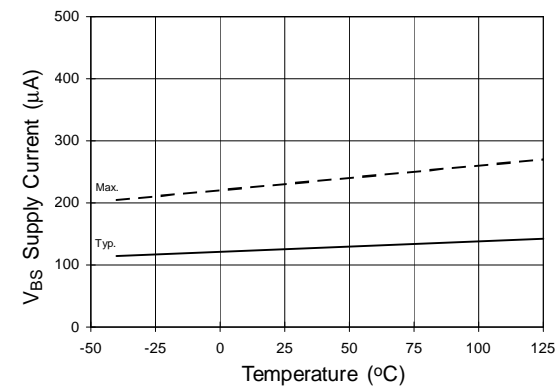

Figure 17A.  $V_{BS}$  Supply Current vs. Temperature

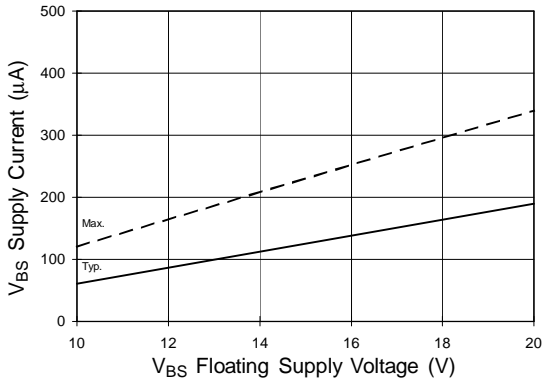

Figure 17B. V<sub>BS</sub> Supply Current vs. Voltage

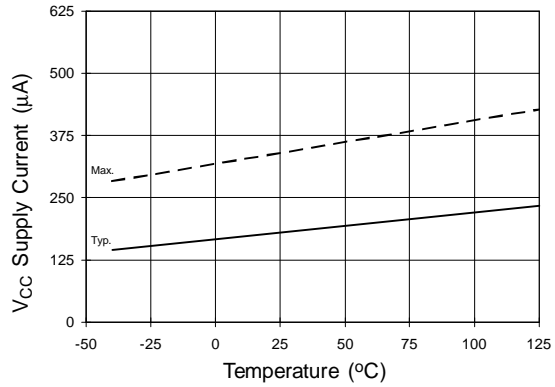

Figure 18A. V<sub>CC</sub> Supply Current vs. Temperature

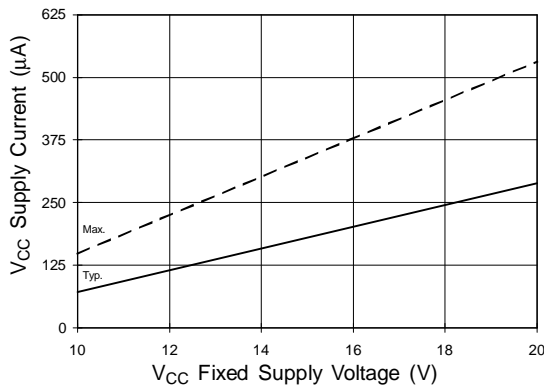

Figure 18B. V<sub>CC</sub> Supply Current vs. Voltage

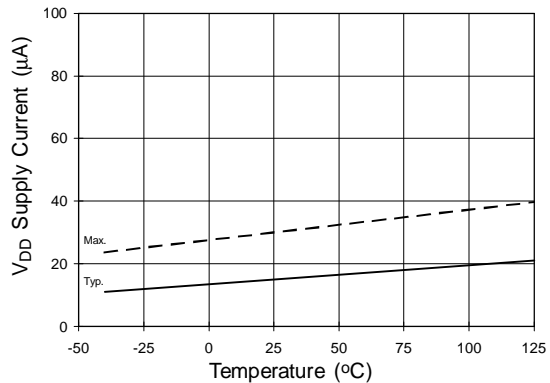

Figure 19A. V<sub>DD</sub> Supply Current vs. Temperature

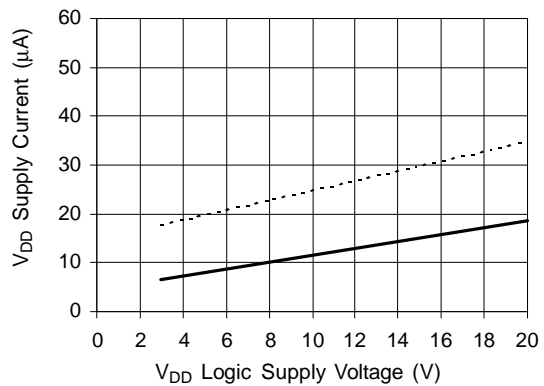

Figure 19B. V<sub>DD</sub> Supply Current vs. V<sub>DD</sub> Voltage

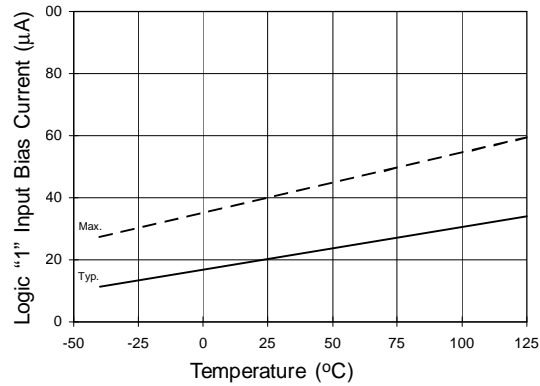

Figure 20A. Logic "1" Input Current vs. Temperature

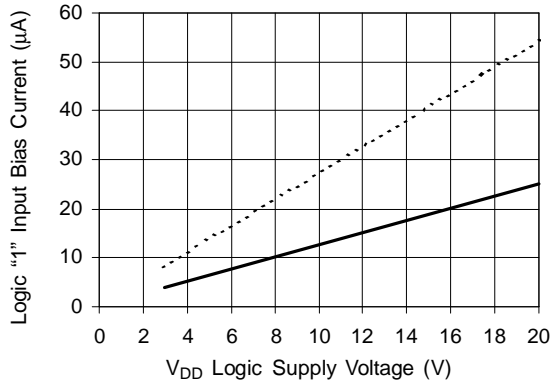

Figure 20B. Logic "1" Input Current vs. V<sub>DD</sub> Voltage

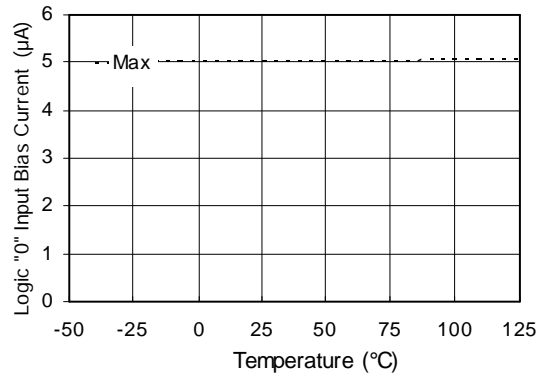

Figure 21A. Logic "0" Input Bias Current vs. Temperature

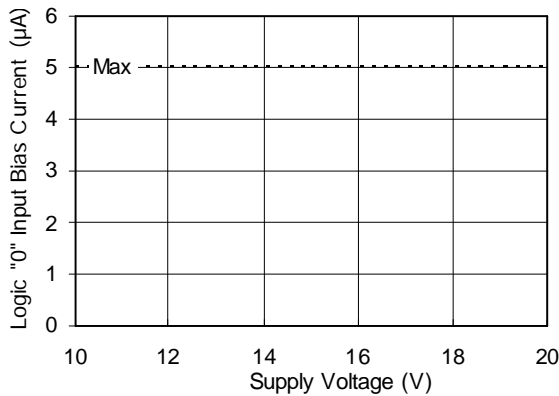

Figure 21B. Logic "0" Input Bias Current vs. Voltage

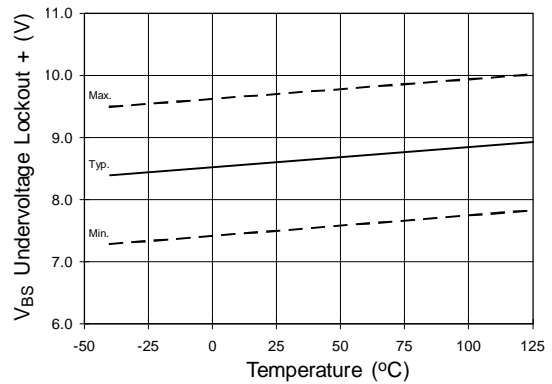

Figure 22. V<sub>BS</sub> Undervoltage (+) vs. Temperature

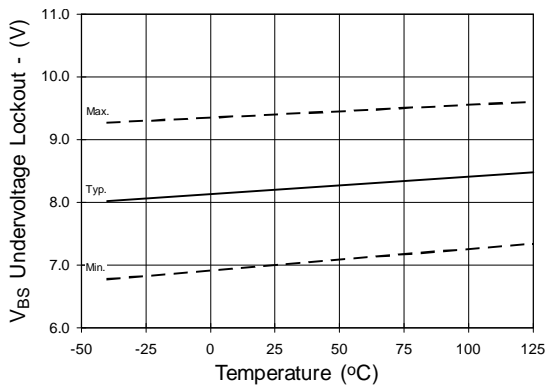

Figure 23. V<sub>BS</sub> Undervoltage (-) vs. Temperature

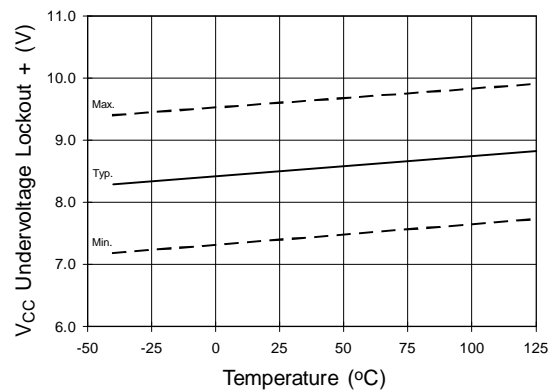

Figure 24. V<sub>CC</sub> Undervoltage (+) vs. Temperature

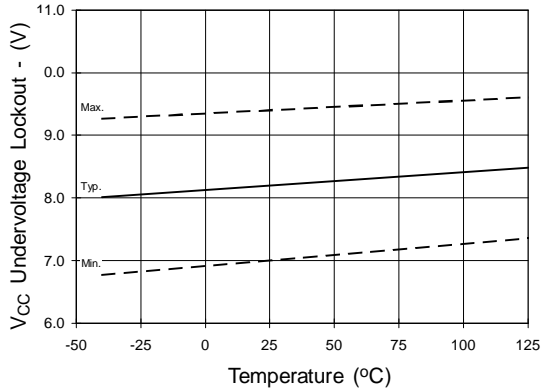

Figure 25. V<sub>CC</sub> Undervoltage (-) vs. Temperature

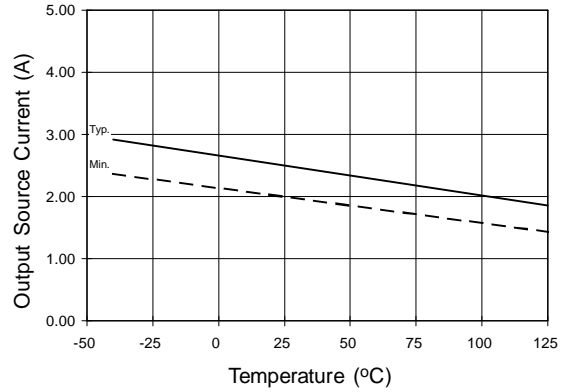

Figure 26A. Output Source Current vs. Temperature

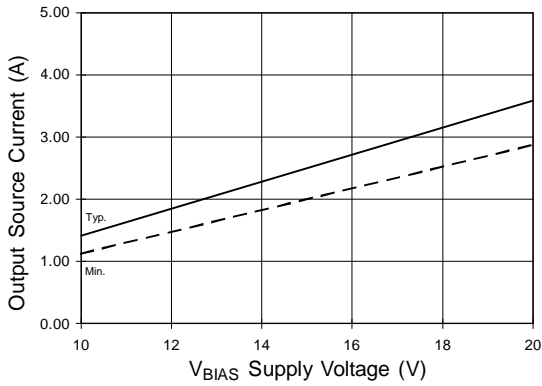

Figure 26B. Output Source Current vs. Voltage

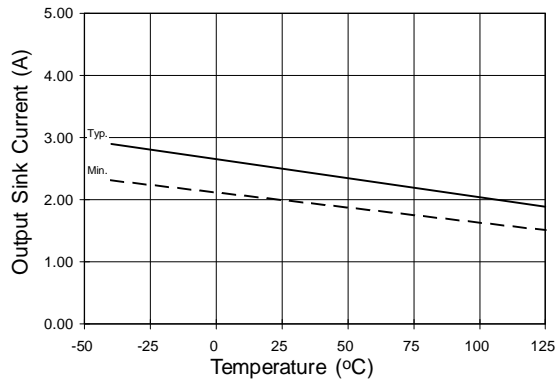

Figure 27A. Output Sink Current vs. Temperature

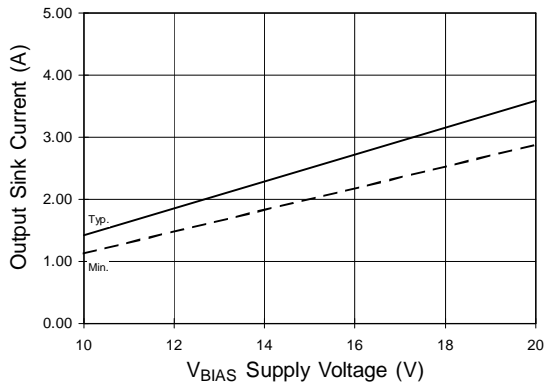

Figure 27B. Output Sink Current vs. Voltage

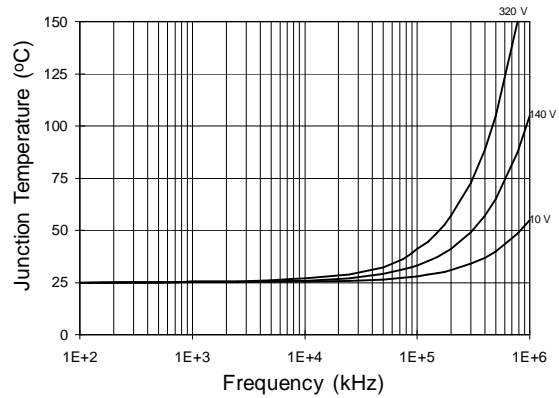

Figure 28. IRS2110/IRS2113 T<sub>J</sub> vs. Frequency (IRFBC20) R<sub>GATE</sub> = 33 W, V<sub>CC</sub> = 15 V

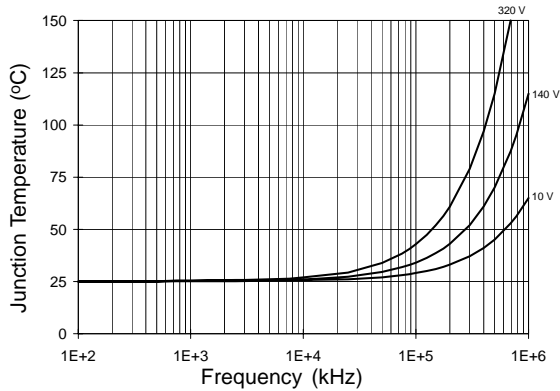

Figure 29. IRS2110/IRS2113 T<sub>J</sub> vs. Frequency (IRFBC30) R<sub>GATE</sub> = 22 Ω, V<sub>CC</sub> = 15 V

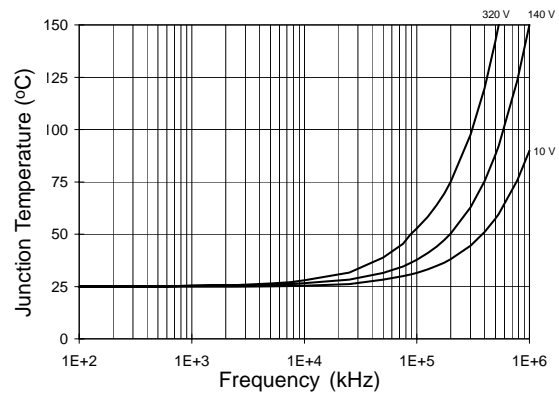

Figure 30. IRS2110/IRS2113 T<sub>J</sub> vs. Frequency (IRFBC40) R<sub>GATE</sub> = 15 Ω, V<sub>CC</sub> = 15 V

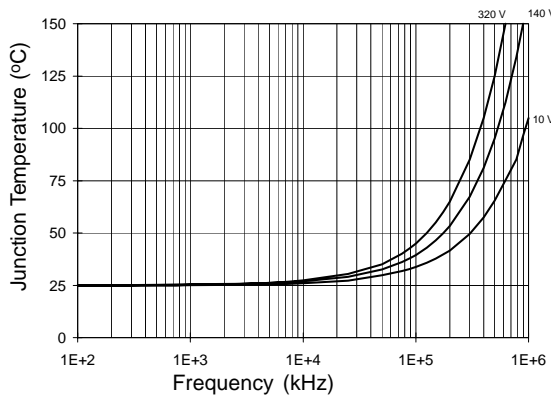

Figure 31. IRS2110/IRS2113 T<sub>J</sub> vs. Frequency (IRFPE50) R<sub>GATE</sub> = 10 Ω, V<sub>CC</sub> = 15 V

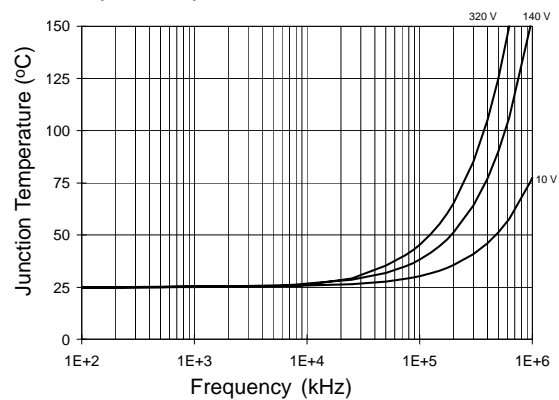

Figure 32. IRS2110S/IRS2113S T<sub>J</sub> vs. Frequency (IRFBC20) R<sub>GATE</sub> = 33 Ω, V<sub>CC</sub> = 15 V

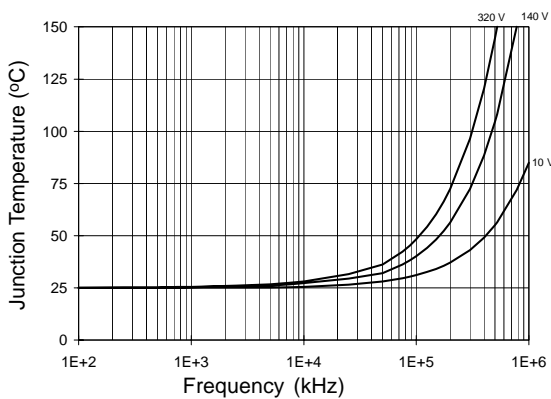

Figure 33. IRS2110S/IRS2113S T<sub>J</sub> vs. Frequency (IRFBC30) R<sub>GATE</sub> = 22 Ω, V<sub>CC</sub> = 15 V

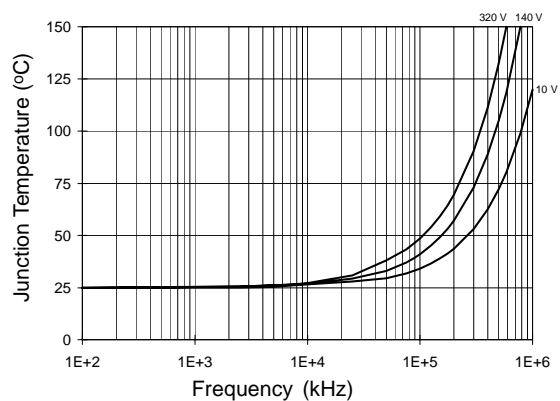

Figure 34. IRS2110S/IRS2113S T<sub>J</sub> vs. Frequency (IRFBC40) R<sub>GATE</sub> = 15 Ω, V<sub>CC</sub> = 15 V

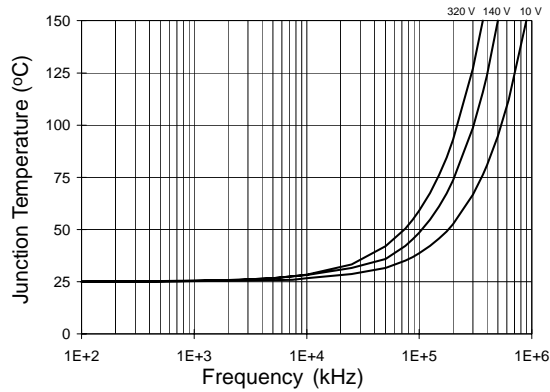

Figure 35. IRS2110S/IRS2113S  $T_J$  vs. Frequency (IRFPE50)  $R_{GATE} = 10 \Omega$ ,  $V_{CC} = 15 V$

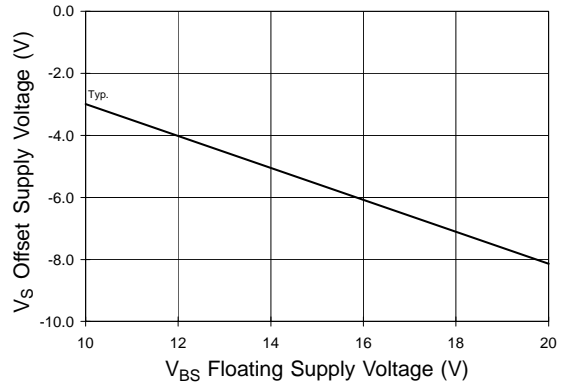

Figure 36. Maximum  $V_S$  Negative Offset vs.  $V_{BS}$  Supply Voltage

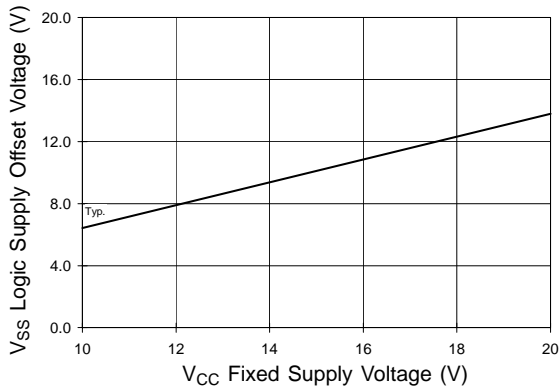
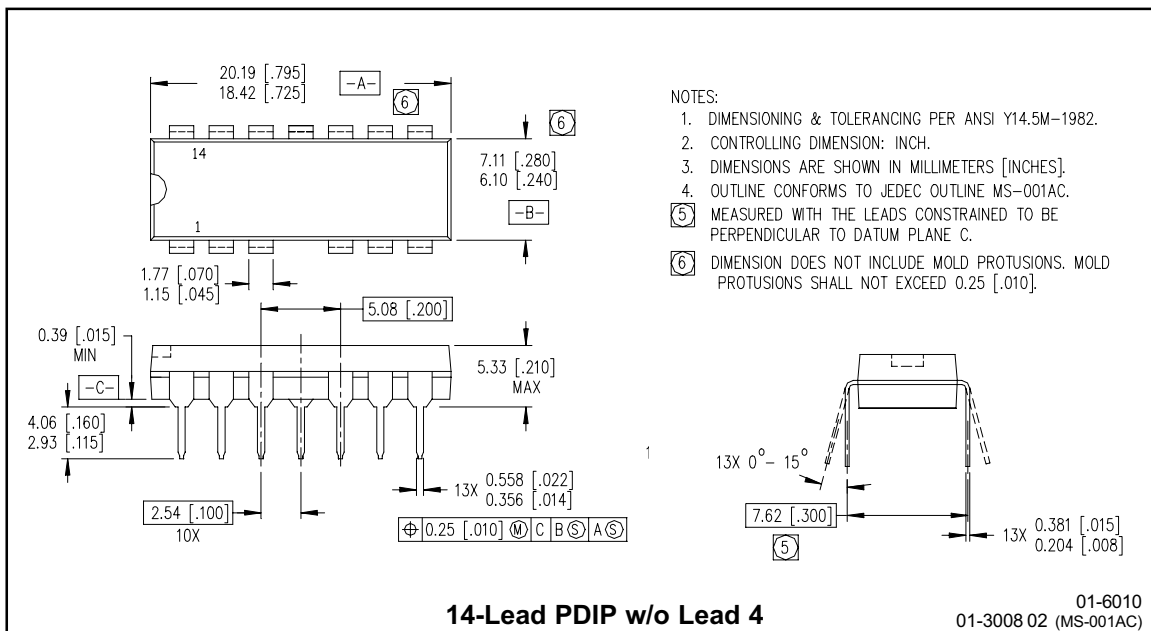
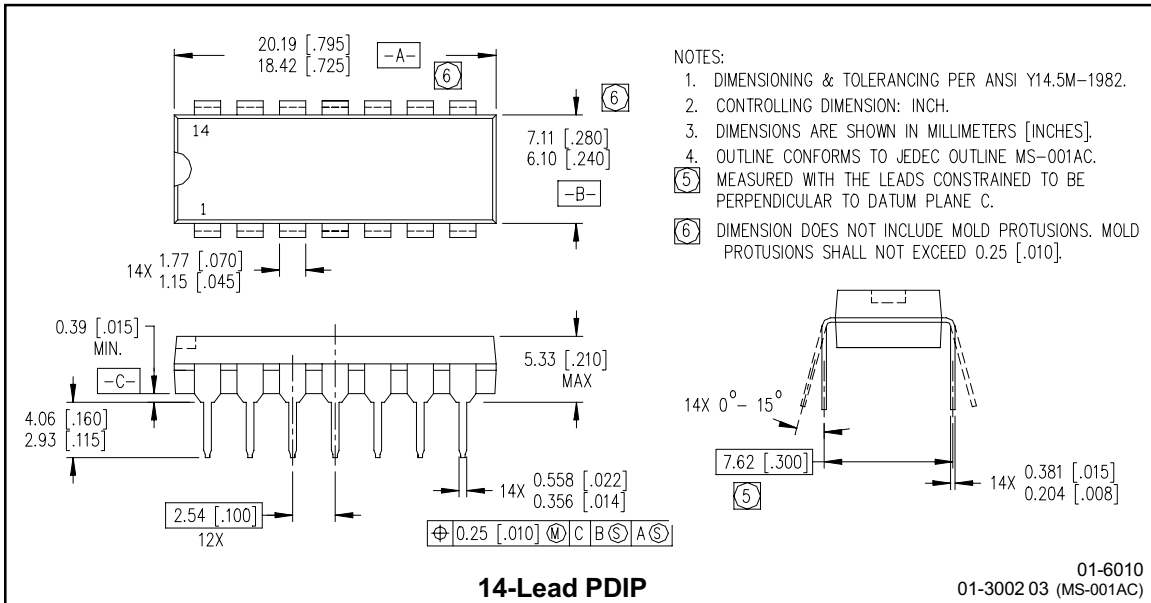
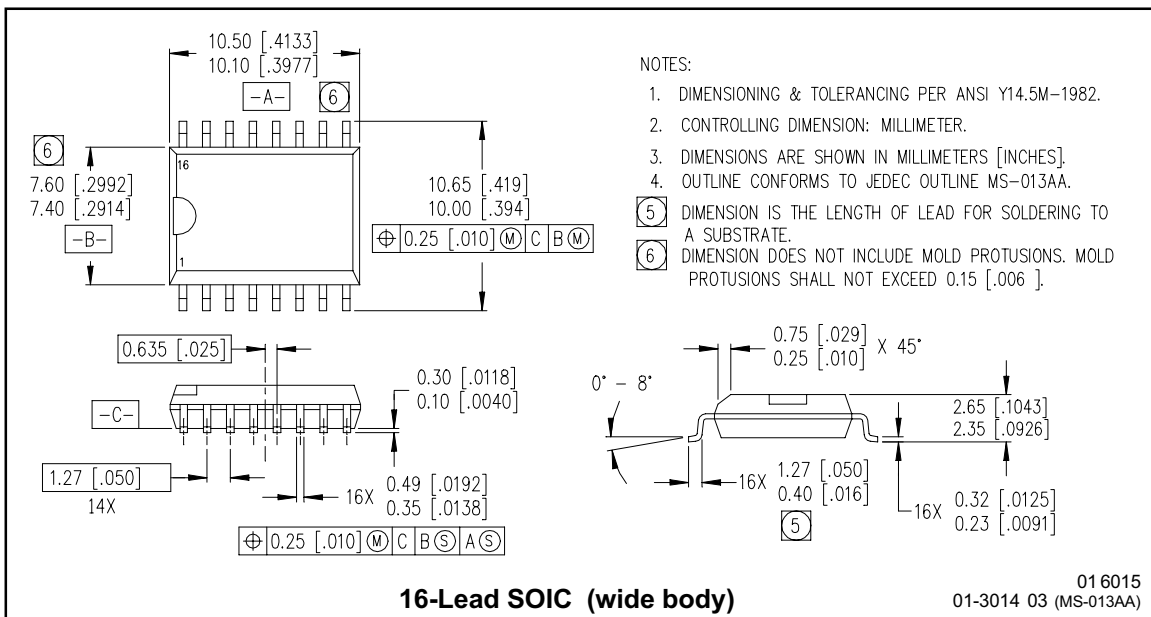
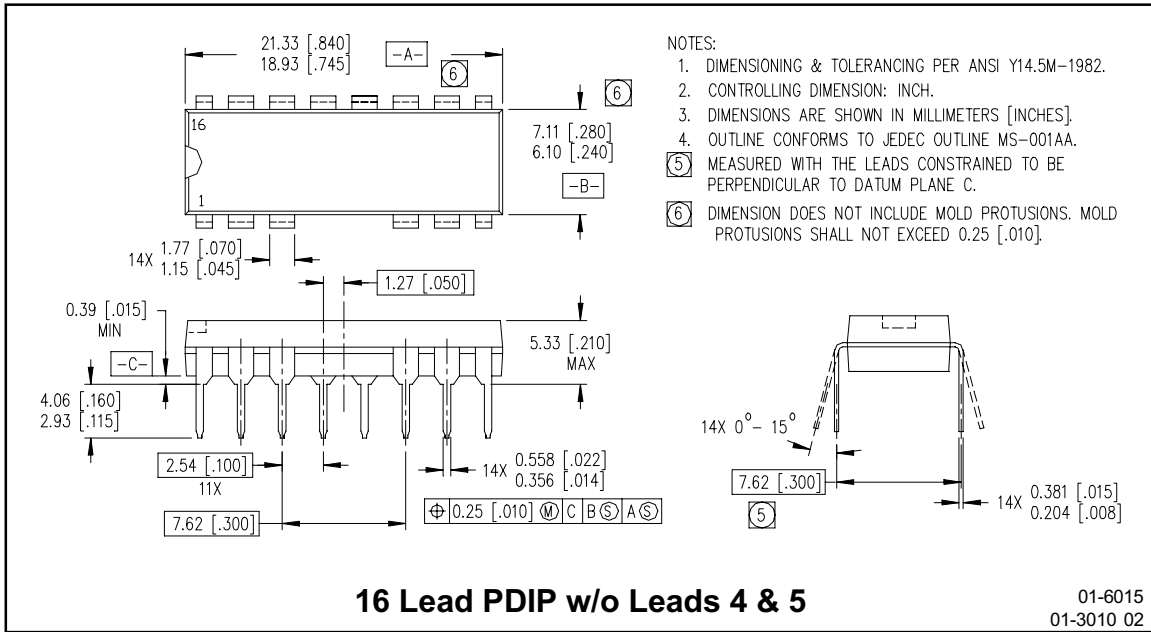

Figure 37. Maximum  $V_{SS}$  Positive Offset vs.  $V_{CC}$  Supply Voltage

Case Outlines







Tape & Reel  
16-Lead SOIC

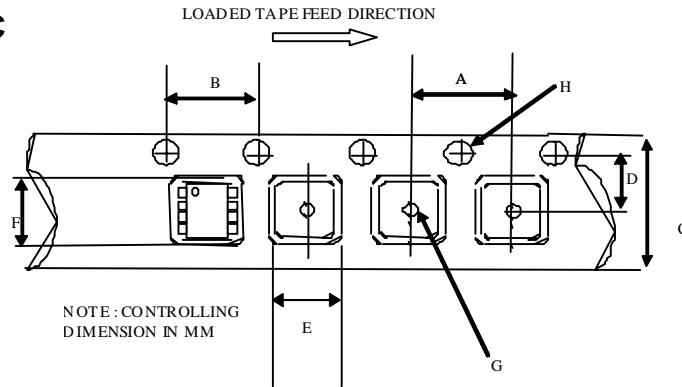

CARRIER TAPE DIMENSION FOR 16SOICW

| Code | Metric |       | Imperial |       |
|------|--------|-------|----------|-------|
|      | Min    | Max   | Min      | Max   |
| A    | 11.90  | 12.10 | 0.468    | 0.476 |
| B    | 3.90   | 4.10  | 0.153    | 0.161 |
| C    | 15.70  | 16.30 | 0.618    | 0.641 |
| D    | 7.40   | 7.60  | 0.291    | 0.299 |
| E    | 10.80  | 11.00 | 0.425    | 0.433 |
| F    | 10.60  | 10.80 | 0.417    | 0.425 |
| G    | 1.50   | n/a   | 0.059    | n/a   |
| H    | 1.50   | 1.60  | 0.059    | 0.062 |

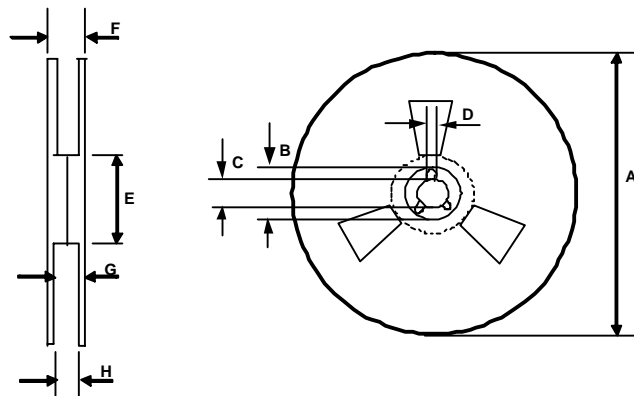

REEL DIMENSIONS FOR 16SOICW

| Code | Metric |        | Imperial |        |
|------|--------|--------|----------|--------|
|      | Min    | Max    | Min      | Max    |
| A    | 329.60 | 330.25 | 12.976   | 13.001 |
| B    | 20.95  | 21.45  | 0.824    | 0.844  |
| C    | 12.80  | 13.20  | 0.503    | 0.519  |
| D    | 1.95   | 2.45   | 0.767    | 0.096  |
| E    | 98.00  | 102.00 | 3.858    | 4.015  |
| F    | n/a    | 22.40  | n/a      | 0.881  |
| G    | 18.50  | 21.10  | 0.728    | 0.830  |
| H    | 16.40  | 18.40  | 0.645    | 0.724  |

# IRS2110(-1,-2,S)PbF/IRS2113(-1,-2,S)PbF

## LEADFREE PART MARKING INFORMATION

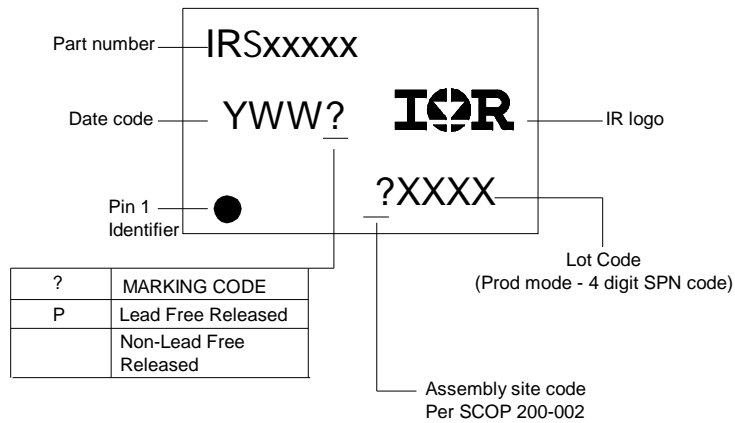

## ORDER INFORMATION

- 14-Lead PDIP IRS2110PbF
- 14-Lead PDIP IRS2110-1PbF
- 14-Lead PDIP IRS2113PbF
- 14-Lead PDIP IRS2113-1PbF
- 16-Lead PDIP IRS2110-2PbF
- 16-Lead PDIP IRS2113-2PbF
- 16-Lead SOIC IRS2110SPbF
- 16-Lead SOIC IRS2113SPbF
- 16-Lead SOIC Tape & Reel IRS2110STRPbF
- 16-Lead SOIC Tape & Reel IRS2113STRPbF