

General Description

TPV321S5 (single)TPV358S8/M8 (dual) are rail-to-rail CMOS are rail-to-rail CMOS operational amplifiers with ultra low offset. Features include wide input common-mode voltage range and broad output voltage swing with operating supply voltage from 2.2V to 5.5V. Products are fully specified over the extended -40 to +125°C temperature range.

TPV321/358 provide 1MHz bandwidth consuming Ultra low current of 40uA per channel . Very low input bias currents of 10pA enable them ideal for integrators,photodiode amplifiers, and piezoelectric sensors

Features

- Single-Supply Operation from +2.2V ~ +5.5V
- Rail-to-Rail Input / Output
- Gain-Bandwidth Product: 1MHz (Typ.)
- Low Input Bias Current: 10pA (Typ.)
- Low Offset Voltage: 5mV (Max.)
- Quiescent Current: 40μA (Typ.)
- Operating Temperature: -40°C ~ +125°C
- Available in SOT23-5 and SOP8 Packages

Applications

- Portable Equipment
- Mobile Communications
- Smoke Detector
- Sensor Interface
- Medical Instrumentation
- Battery-Powered Instruments
- Handheld Test Equipment

Pin Assignments

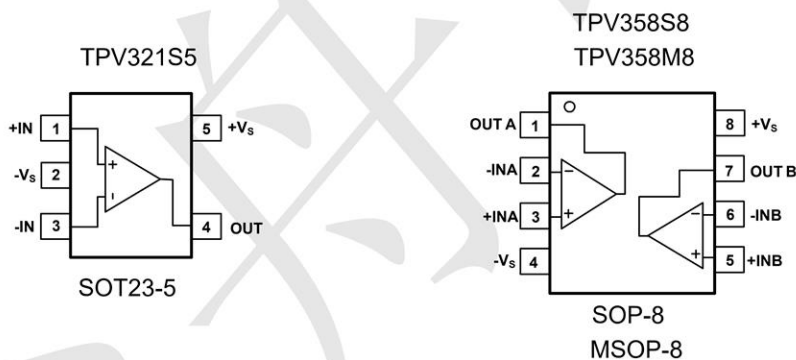

FPin Assignment Diagram (SOT23-5 and SOP-8 MSOP-8 Package)

Package/Ordering Information

Order Number	Package Description	Package Option
TPV321S5	SOT23-5	Tape and Reel 3000
TPV358M8	MSOP-8	Tape and Reel 2500 Or 4000
TPV358S8	SOP8	Tape and Reel 4000

Absolute Maximum Ratings

Condition	Min	Max
Power Supply Voltage (V_{DD} to V_{SS})	-0.5V	+7V
Analog Input Voltage (IN+ or IN-)	$V_{SS}-0.5V$	$V_{DD}+0.5V$
PDB Input Voltage	$V_{SS}-0.5V$	+7V
Operating Temperature Range	-40°C	+125°C
Junction Temperature		+150°C
Storage Temperature Range	-65°C	+150°C
Lead Temperature (soldering, 10sec)		+300°C
Package Thermal Resistance ($T_A=+25^\circ\text{C}$)		
SOT23-5, θ_{JA}		190°C
SOP-8, θ_{JA}		130°C

Note: Stress greater than those listed under Absolute Maximum Ratings may cause permanent damage to the device. This is a stress rating only and functional operation of the device at these or any other conditions outside those indicated in the operational sections of this specification are not implied. Exposure to absolute maximum rating conditions for extended periods may affect reliability.

Electrical Characteristics ($T_A=25^{\circ}\text{C}$ unless otherwise noted)

($V_{DD} = +5\text{V}$, $V_{SS} = 0\text{V}$, $V_{CM} = 0\text{V}$, $V_{OUT} = V_{DD}/2$, $R_L=100\text{K}$ tied to $V_{DD}/2$, $\text{SHDNB} = V_{DD}$, $T_A = -40^{\circ}\text{C}$ to $+125^{\circ}\text{C}$, unless otherwise noted. Typical values are at $T_A = +25^{\circ}\text{C}$.) (Notes 1)

Parameter	Symbol	Conditions	Min.	Typ.	Max.	Units
Supply-Voltage Range	V_{DD}	Guaranteed by the PSRR test	2.2	-	5.5	V
Quiescent Supply Current (per Amplifier)	I_Q	$V_{DD} = 5\text{V}$	30	40	60	μA
Input Offset Voltage	V_{OS}		-	0.5	± 5	mV
Input Offset Voltage Tempco	$\Delta V_{OS}/\Delta T$		-	2	-	$\mu\text{V}/^{\circ}\text{C}$
Input Bias Current	I_B	(Note 2)	-	10	-	pA
Input Offset Current	I_{OS}	(Note 2)	-	10	-	pA
Input Common-Mode Voltage Range	V_{CM}		-0.1	-	$V_{DD}+0.1$	V
Common-Mode Rejection Ratio	CMRR	$V_{DD}=5.5\text{V}$, $V_{SS}=0.1\text{V}$, $0.1\text{V} \leq V_{CM} \leq V_{DD}+0.1\text{V}$	55	65	-	dB
		$V_{SS} \leq V_{CM} \leq 5\text{V}$	60	80	-	dB
Power-Supply Rejection Ratio	PSRR	$V_{DD} = +2.5\text{V}$ to $+5.5\text{V}$	75	94	-	dB
Open-Loop Voltage Gain	A_V	$V_{DD}=5\text{V}$, $R_L=100\text{k}\Omega$, $0.05\text{V} \leq V_O \leq 4.95\text{V}$	100	110	-	dB
		$V_{DD}=5\text{V}$, $R_L=5\text{k}\Omega$, $0.05\text{V} \leq V_O \leq 4.95\text{V}$	70	80	-	dB
Output Voltage Swing	V_{OUT}	$ V_{IN+}-V_{IN-} \geq 10\text{mV}$ $V_{DD}-V_{OH}$	-	6	-	mV
		$R_L = 100\text{k}\Omega$ to $V_{DD}/2$ $V_{OL}-V_{SS}$	-	6	-	mV
		$ V_{IN+}-V_{IN-} \geq 10\text{mV}$ $V_{DD}-V_{OH}$	-	60	-	mV
		$R_L = 5\text{k}\Omega$ to $V_{DD}/2$ $V_{OL}-V_{SS}$	-	60	-	mV
Output Short-Circuit Current	I_{SC}	Sinking or Sourcing	-	± 20	-	mA
Gain Bandwidth Product	GBW	$A_V = +1\text{V}/\text{V}$	-	1	-	MHz
Slew Rate	SR	$A_V = +1\text{V}/\text{V}$	-	0.6	-	$\text{V}/\mu\text{s}$
Settling Time	t_S	To 0.1%, $V_{OUT} = 2\text{V}$ step $A_V = +1\text{V}/\text{V}$	-	5	-	μs
Over Load Recovery Time		$V_{IN} \times \text{Gain} = V_S$	-	2	-	μs
Input Voltage Noise Density	e_n	$f = 10\text{kHz}$	-	20	-	$\text{nV}/\sqrt{\text{Hz}}$

Note 1: All devices are 100% production tested at $T_A = +25^{\circ}\text{C}$; all specifications over the automotive temperature range is guaranteed by design, not production tested.

Note 2: Parameter is guaranteed by design.

TYPICAL PERFORMANCE CHARACTERISTICS

At $T_A=+25^{\circ}\text{C}$, $R_L=100\text{ k}\Omega$ connected to $V_S/2$ and $V_{OUT}=V_S/2$, unless otherwise noted.

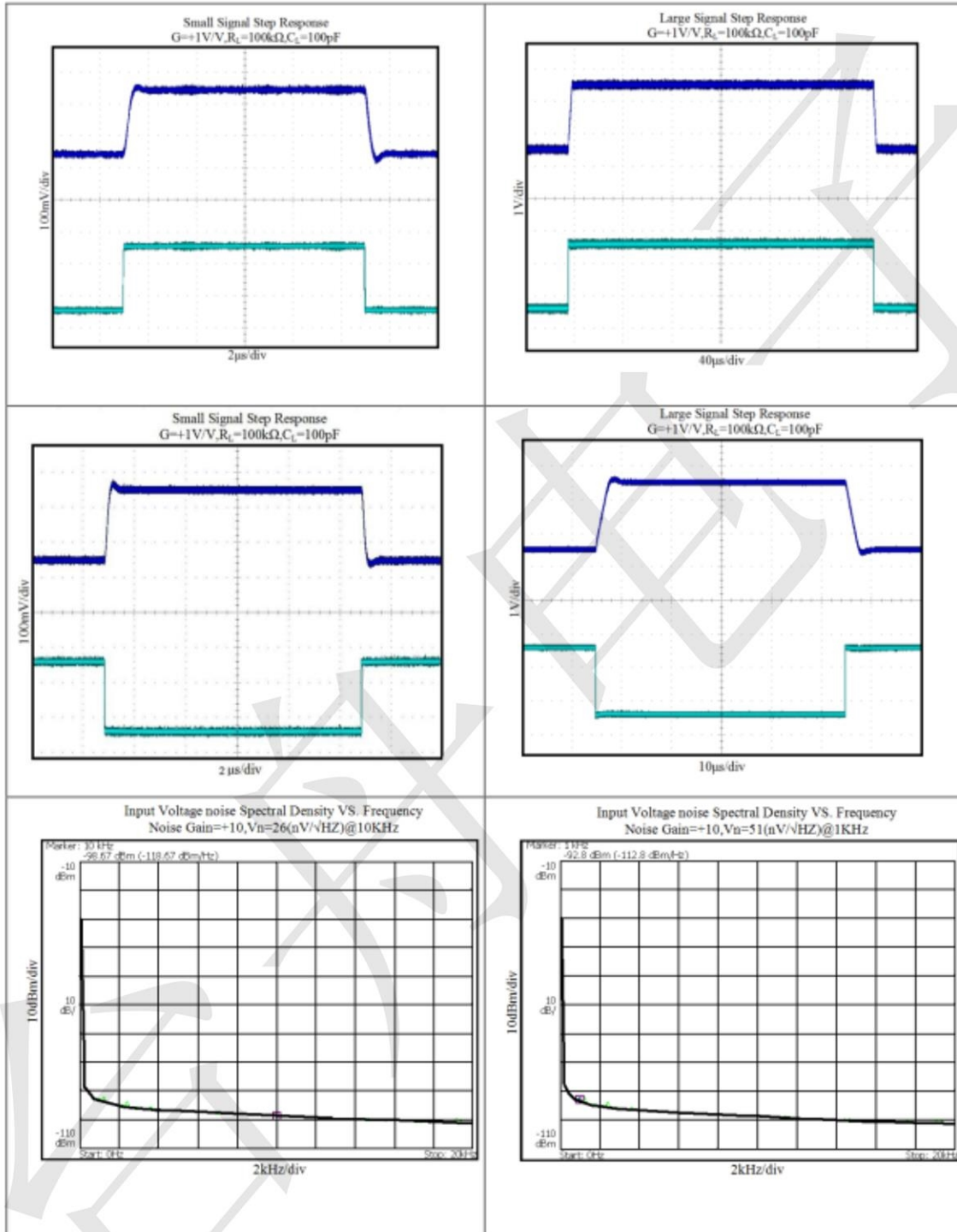

At $T_A=+25^\circ\text{C}$, $R_L=100\text{ k}\Omega$ connected to $V_S/2$ and $V_{OUT}=V_S/2$, unless otherwise noted.

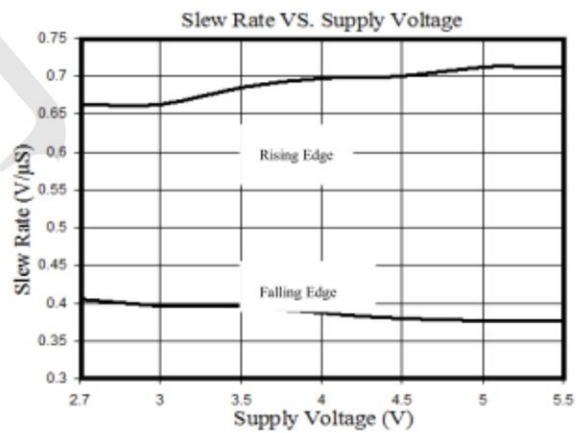
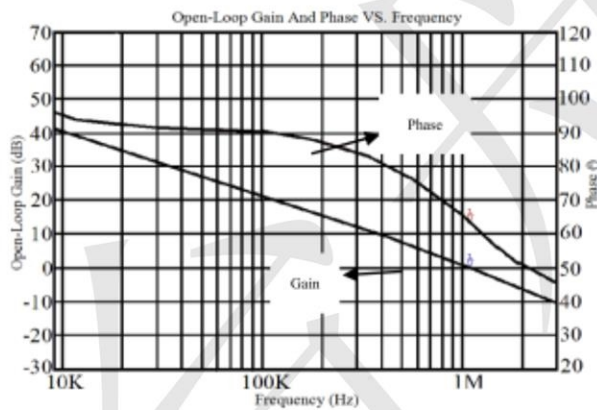
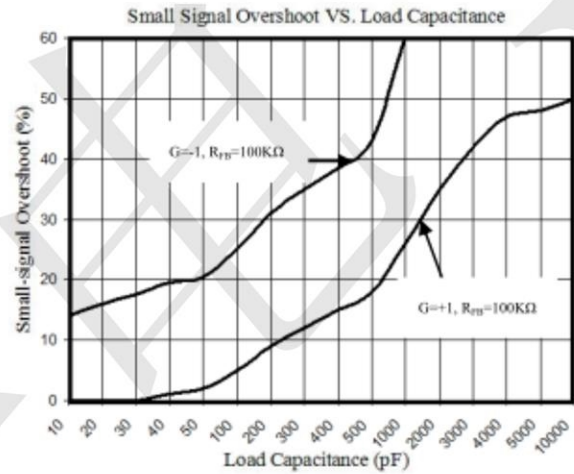
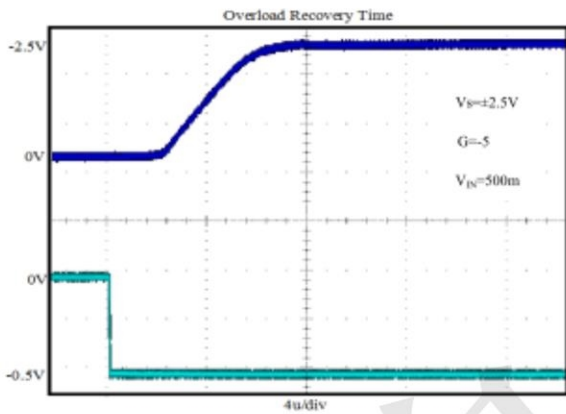
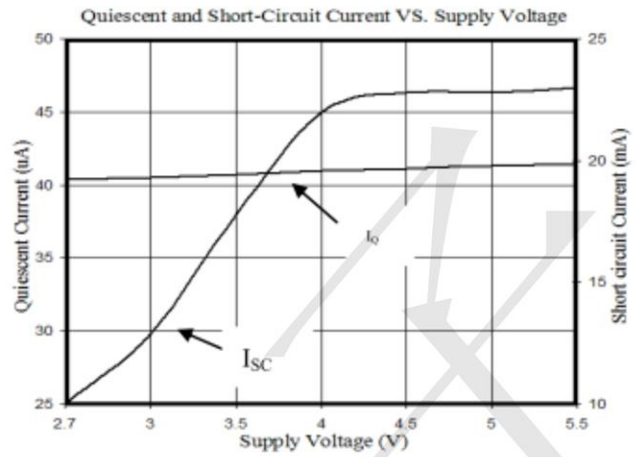
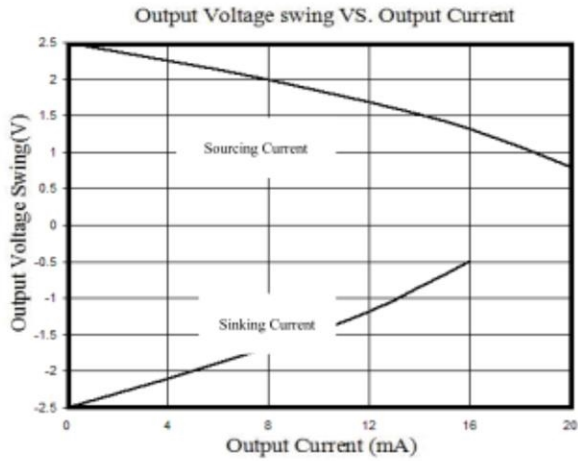

Package Information

SOT23-5

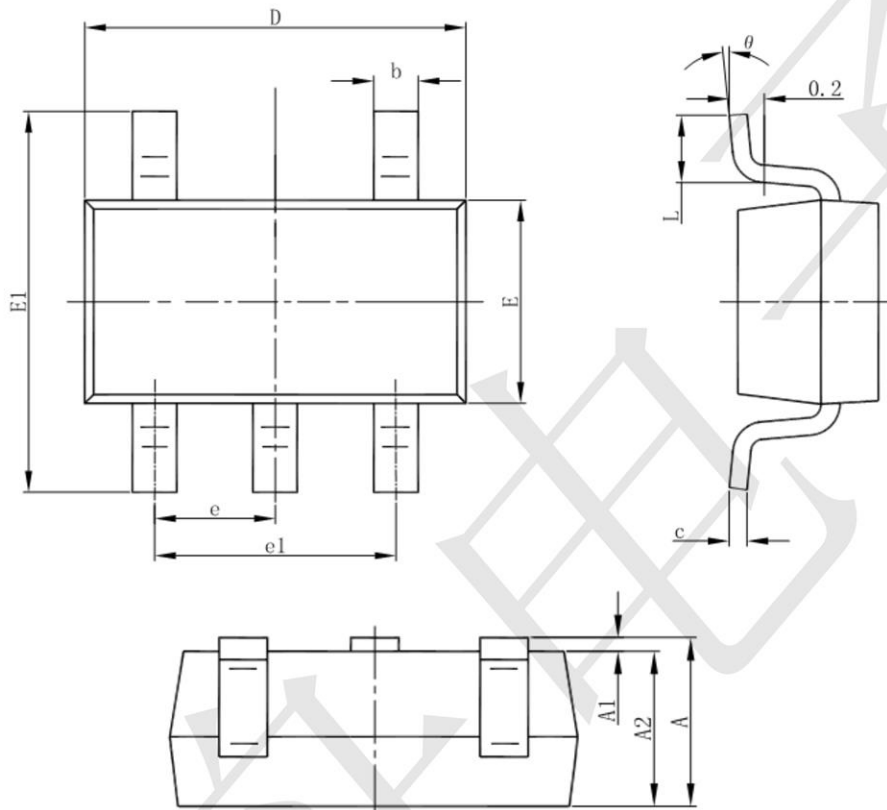

Symbol	Dimensions In Millimeters		Dimensions In Inches	
	Min	Max	Min	Max
A	1.050	1.250	0.041	0.049
A1	0.000	0.100	0.000	0.004
A2	1.050	1.150	0.041	0.045
b	0.300	0.500	0.012	0.020
c	0.100	0.200	0.004	0.008
D	2.820	3.020	0.111	0.119
E	1.500	1.700	0.059	0.067
E1	2.650	2.950	0.104	0.116
e	0.950(BSC)		0.037(BSC)	
e1	1.800	2.000	0.071	0.079
L	0.300	0.600	0.012	0.024
theta	0°	8°	0°	8°

MSOP8

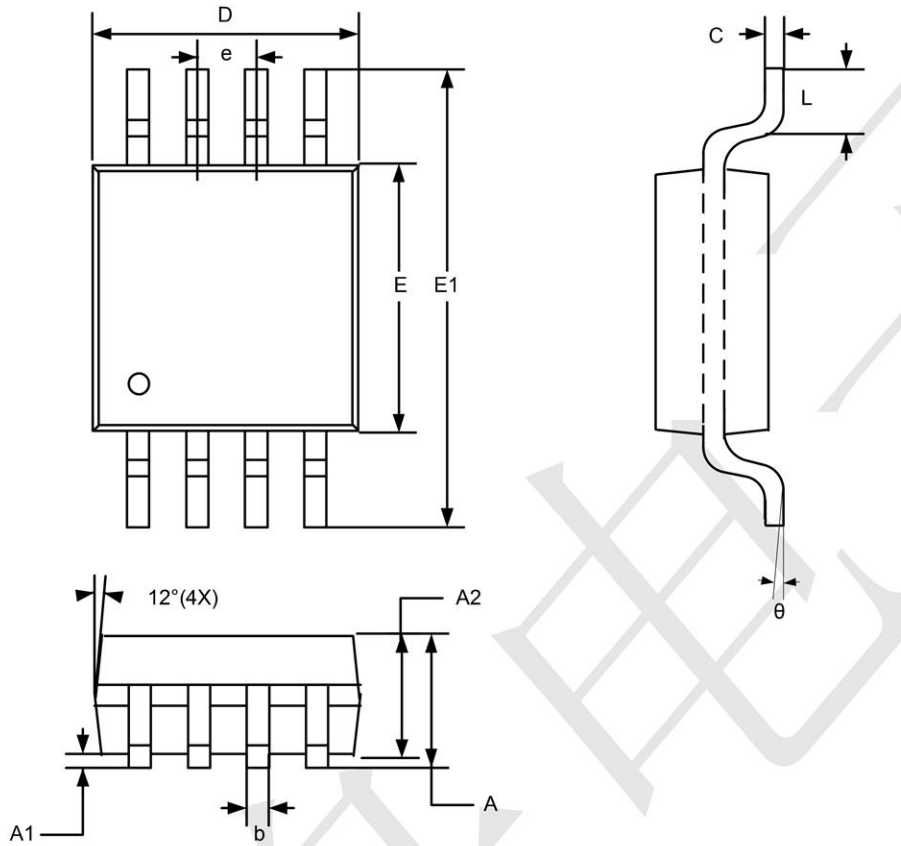

SYMBOLS	DIMENSIONS IN MILLIMETERS			DIMENSIONS IN INCHES		
	MIN	NOM	MAX	MIN	NOM	MAX
A	--	--	1.10	--	--	0.043
A1	0.05	--	0.15	0.002	--	0.006
A2	0.75	0.85	0.95	0.030	0.033	0.037
b	0.25	--	0.40	0.010	--	0.016
C	0.13	--	0.23	0.005	--	0.009
D	2.90	3.00	3.10	0.114	0.118	0.122
E	2.90	3.00	3.10	0.114	0.118	0.122
E1	4.90 BSC			0.193 BSC		
e	0.65 BSC			0.026 BSC		
L	--	--	0.55	--	--	0.022
theta	0	--	7°	0	--	7°

SOP-8

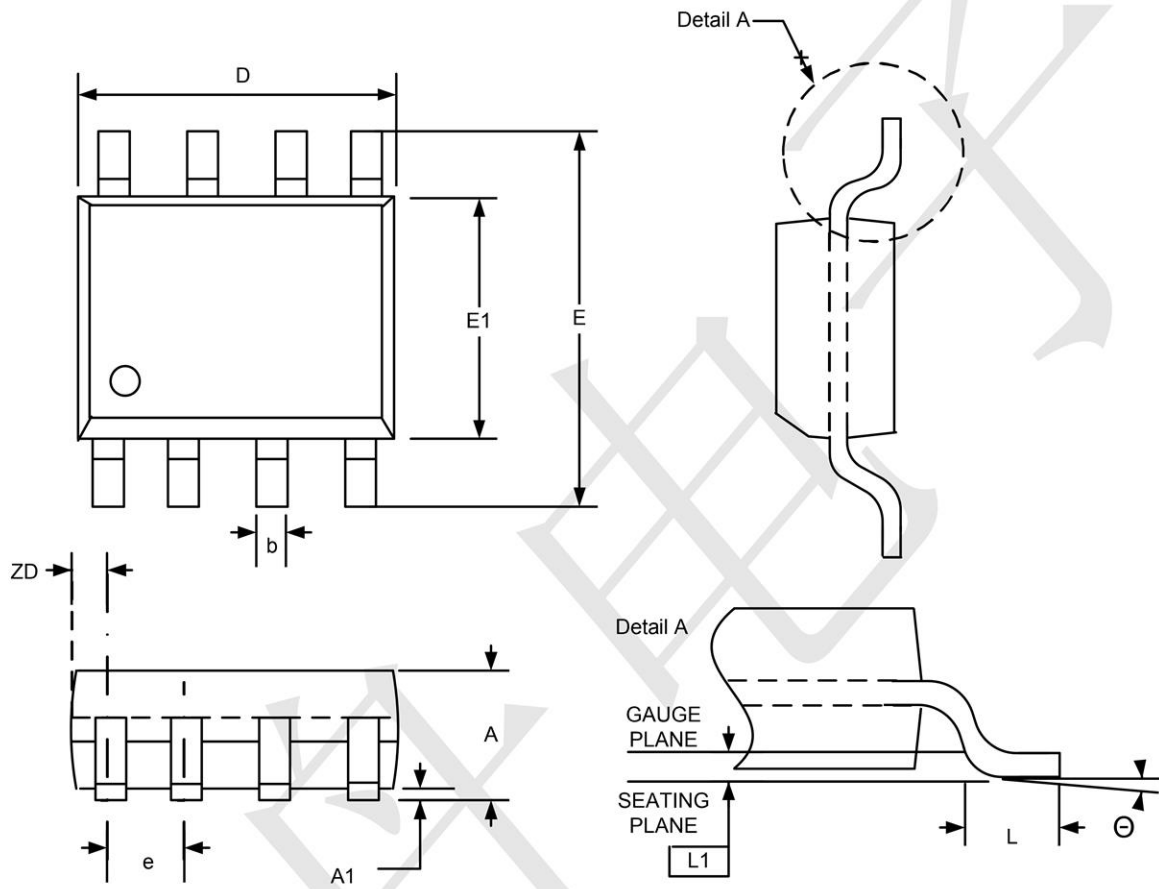

SYMBOLS	DIMENSIONS IN MILLIMETERS			DIMENSIONS IN INCHES		
	MIN	NOM	MAX	MIN	NOM	MAX
A	1.35	--	1.75	0.053	--	0.069
A1	0.10	--	0.25	0.004	--	0.010
b	0.33	--	0.51	0.013	--	0.020
D	4.80	--	5.00	0.189	--	0.197
E	5.80	--	6.20	0.228	--	0.244
E1	3.80	--	4.00	0.150	--	0.157
e	1.27 BSC.			0.050 BSC.		
L	0.38	--	1.27	0.015	--	0.050
L1	0.25 BSC.			0.010 BSC.		
ZD	0.545 REF.			0.021 REF.		
Theta	0	--	8°	0	--	8°