



GLASS PASSIVATED BRIDGE RECTIFIERS

REVERSE VOLTAGE - 50 to 1000 Volts
FORWARD CURRENT - 2.0 Amperes

FEATURES

- Rating to 1000V PRV
- Ideal for printed circuit board
- Reliable low cost construction utilizing molded plastic technique
- The plastic material has UL flammability classification 94V#0

KBP

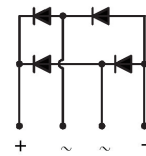
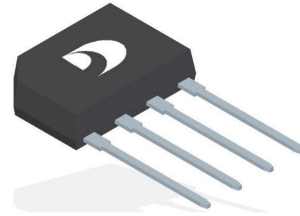

MECHANICAL DATA

- Polarity : As marked on body
- Weight : 0.05 ounces, 1.52 grams
- Mounting position : Any

MAXIMUM RATINGS AND ELECTRICAL CHARACTERISTICS

Ratings at 25°C ambient temperature unless otherwise specified.

CHARACTERISTICS	SYMBOL	KBP	KBP	KBP	KBP	KBP	KBP	KBP	UNIT
		2005G	201G	202G	204G	206G	208G	210G	
Maximum Repetitive Peak Reverse Voltage	V_{RRM}	50	100	200	400	600	800	1000	V
Maximum RMS Voltage	V_{RMS}	35	70	140	280	420	560	700	V
Maximum DC Blocking Voltage	V_{DC}	50	100	200	400	600	800	1000	V
Maximum Average Forward Rectified Current @ $T_C=100^\circ C$	$I_{(AV)}$	2.0							A
Peak Forward Surge Current 8.3ms single half sine-wave	I_{FSM}	55							A
Peak Forward Surge Current 1.0ms single half sine-wave	I_{FSM}	110							A
Maximum Forward Voltage at 2.0A DC	V_F	1.1							V
Maximum DC Reverse Current at rated Blocking Voltage	I_R	5.0 500							μA
I^2t Rating for fusing ($3ms \leq t \leq 8.3ms$)	I^2t	17.5							A^2s
Typical Junction Capacitance per element (Note 1)	C_J	25							pF
Typical thermal resistance (Note 2)	$R_{\theta JC}$	10							$^\circ C/W$
	$R_{\theta JL}$	18							
	$R_{\theta JA}$	40							
Operation Temperature Range	T_J	-55 to 150							$^\circ C$
Storage Temperature Range	T_{STG}	-55 to 150							$^\circ C$

Note: (1) Measured at 1.0MHz and applied reverse voltage of 4.0V DC.

(2) Thermal Resistance Junction to Case, Lead and Ambient.



FIG.1- FORWARD CURRENT DERATING CURVE

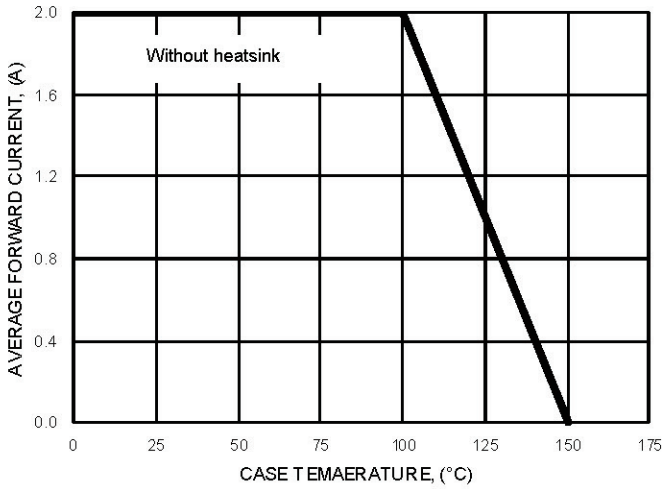

FIG.2- MAXIMUM NON-REPETITIVE SURGE CURRENT

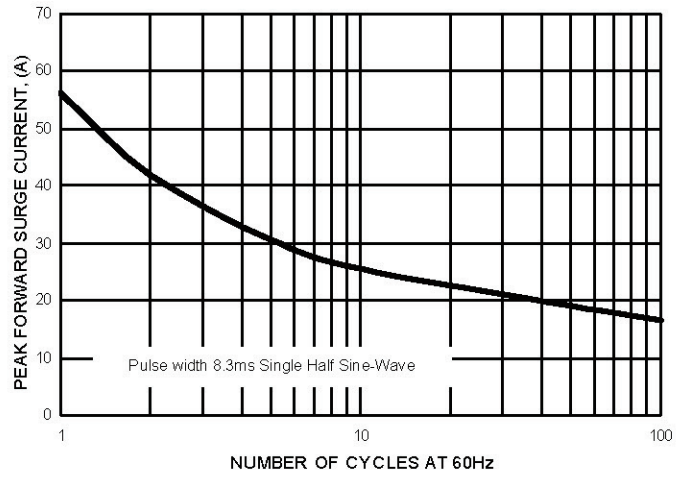

FIG.3- TYPICAL JUNCTION CAPACITANCE

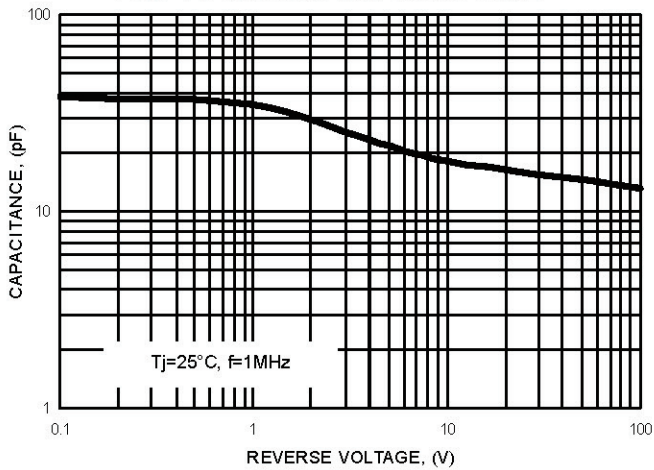

FIG.4- TYPICAL FORWARD CHARACTERISTICS

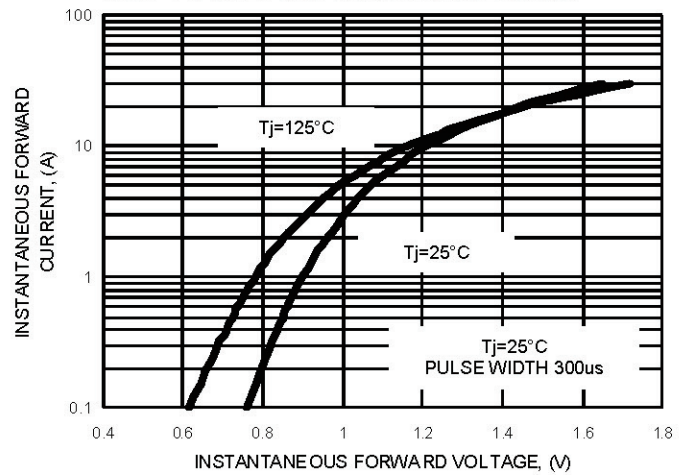
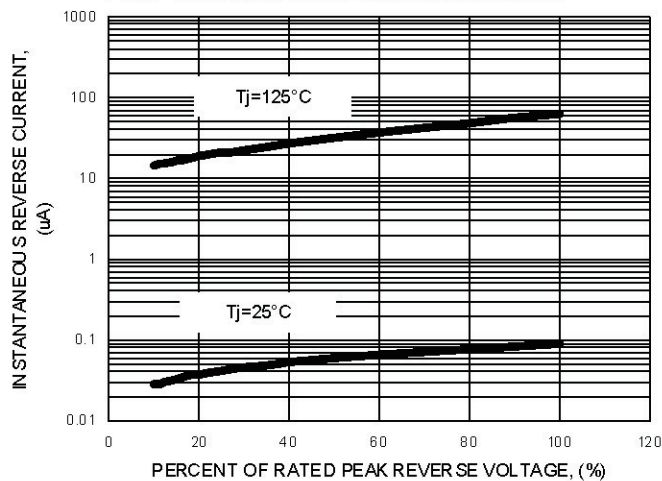
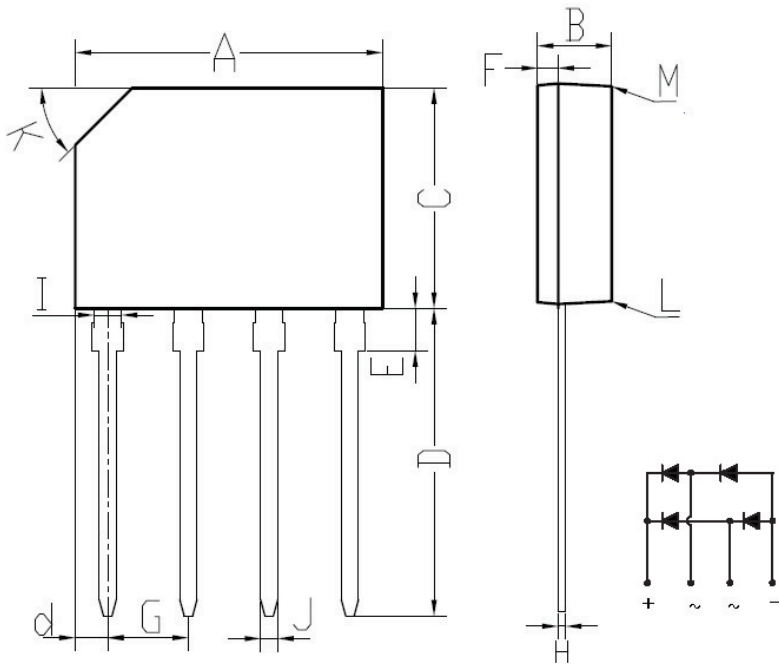

FIG.5- TYPICAL REVERSE CHARACTERISTICS





KBP Package Outline Dimensions



KBP		
DIM.	MIN.	MAX.
A	14.25	14.75
B	3.35	3.65
C	10.20	10.60
D	14.25	14.73
d	1.40	1.70
E	1.80	2.20
F	0.80	1.10
G	3.56	4.06
H	0.35	0.55
I	1.22	1.42
J	0.76	0.86
K	2.7 x 45° (Typ)	
L	#	3°
M	#	2°
All Dimensions in millimeter		