

Features

- * 350W peak pulse power (8/20 μ s)
- * Low operating :8V
- * Ultra low capacitance: 1.0 pF typical
- * Ultra low leakage: nA level
- * Low clamping voltage
- * Protects one power line or data line
- * Complies with following standards:
 - IEC 61000-4-2 (ESD) immunity test
Air discharge: \pm 30kV
Contact discharge: \pm 30kV
 - IEC61000-4-4 (EFT) 40A (5/50ns)
- * RoHS Compliant

Mechanical Characteristics

- * Package: SOD-323
- * Ultra low leakage: nA level
- * Case Material: "Green" Molding Compound.
- * UL Flammability Classification Rating 94V-0
- * Moisture Sensitivity: Level 3 per J-STD-020

Applications

- * Cellular Handsets and Accessories
- * Personal Digital Assistants
- * Notebooks and Handhelds
- * Portable Instrumentation
- * Peripherals

Ordering Information

Part Number	Qty per Reel	Reel Size
TPGC08C	3000	7"

Dimensions and Pin Configuration

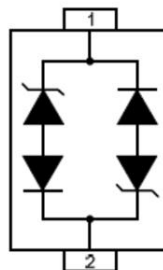

Absolute Maximum Ratings (Tamb=25°C unless otherwise specified)

Parameter	Symbol	Value	Unit
ESD per IEC 61000-4-2 (Air)	VESD	±30	kV
ESD per IEC 61000-4-2 (Contact)		±30	
Operating Temperature Range	TJ	-55 to +125	°C
Storage Temperature Range	Tstg	-55 to +150	°C

Electrical Characteristics (TA=25°C unless otherwise specified)

Symbol	Parameter
V_{RWM}	Nominal Reverse Working Voltage
I_R	Reverse Leakage Current @ V_{RWM}
V_{BR}	Reverse Breakdown Voltage @ I_T
I_T	Test Current for Reverse Breakdown
V_C	Clamping Voltage @ I_{PP}
I_{PP}	Maximum Peak Pulse Current
C_{ESD}	Parasitic Capacitance
V_R	Reverse Voltage
f	Small Signal Frequency

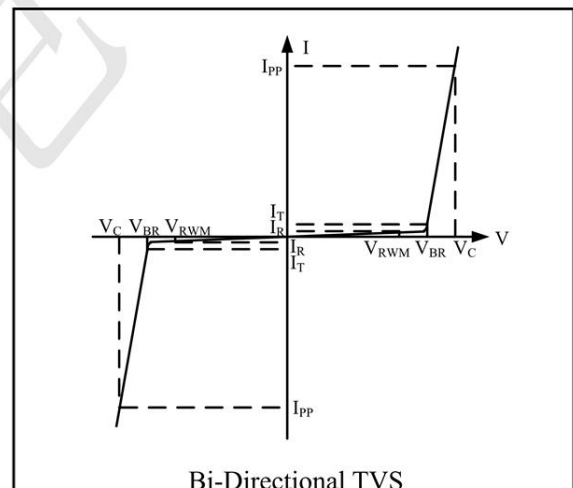

Parameter	Symbol	Test Condition	Min	Typ	Max	Unit
Reverse Working Voltage	V_{RWM}				8	V
Breakdown Voltage	V_{BR}	$I_T = 1\text{mA}$	8.7			V
Reverse Leakage Current	I_R	$V_{RWM} = 8\text{V}$			0.2	μA
Clamping Voltage	V_C	$I_{PP} = 1\text{A}$ (8 x 20 μs pulse)			13	V
Clamping Voltage	V_C	$I_{PP} = 18\text{A}$ (8 x 20 μs pulse)			20	V
Junction Capacitance	C_J	$V_R = 0\text{V}$, f = 1MHz		1		pF

Electrical Characteristics ($T_A=25^\circ\text{C}$ unless otherwise specified)

Fig1. 8/20 μs Pulse Waveform

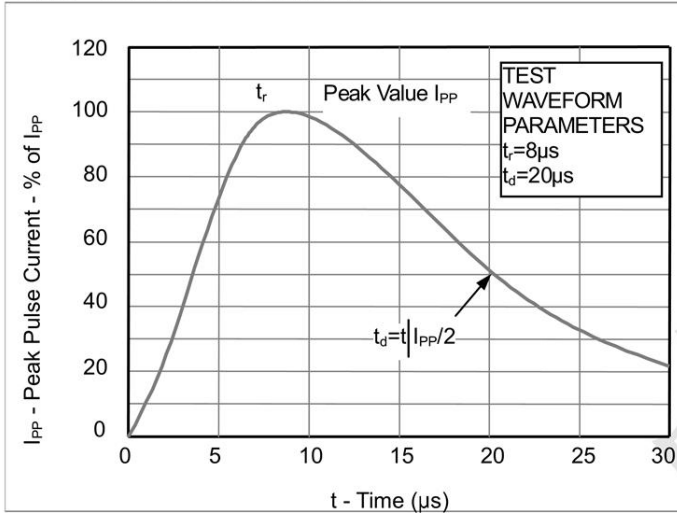

Fig2. ESD Pulse Waveform (according to IEC 61000-4-2)

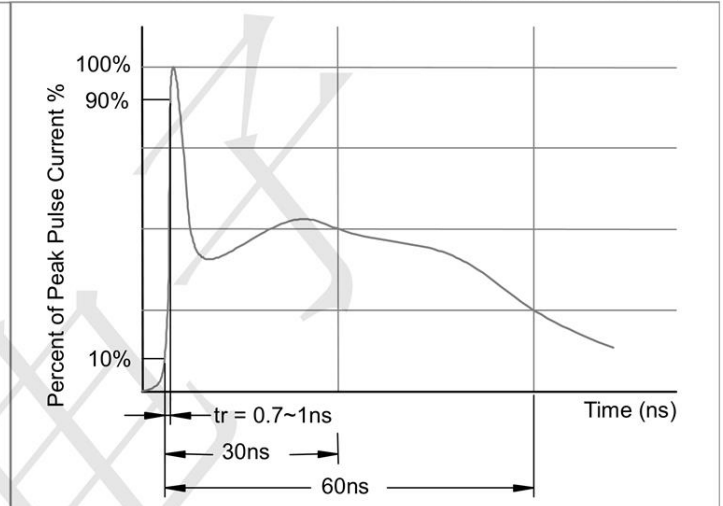
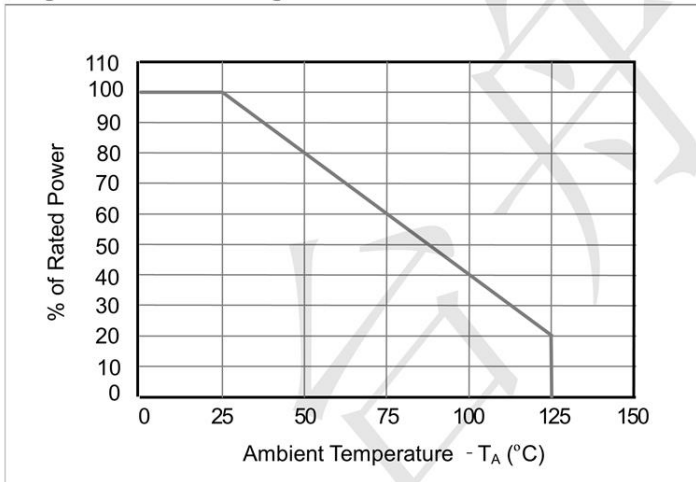
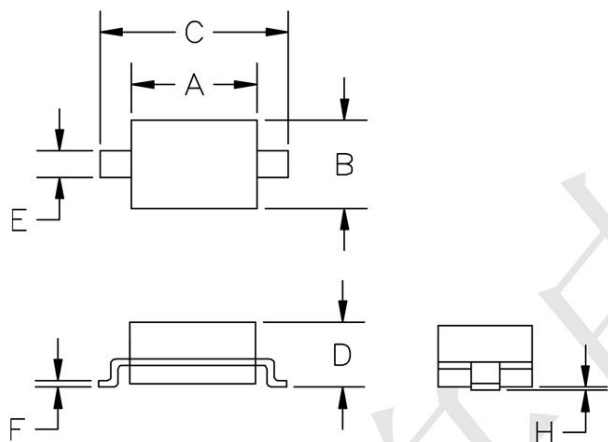

Fig3. Power Derating Curve



Outline Drawing - SOD-323



SYM	DIMENSIONS			
	MILLIMETERS		INCHES	
	MIN	MAX	MIN	MAX
A	1.50	1.80	0.060	0.071
B	1.20	1.40	0.045	0.054
C	2.30	2.70	0.090	0.107
D	-	1.10	-	0.043
E	0.30	0.40	0.012	0.016
F	0.10	0.25	0.004	0.010
H	-	0.10	-	0.004

Land Pattern - SOD-323

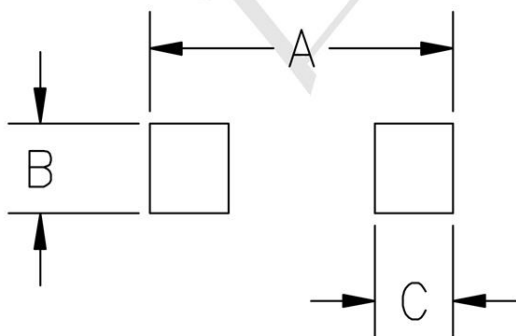

SYM	DIMENSIONS	
	MILLIMETERS	INCHES
A	3.15	0.120
B	0.80	0.031
C	0.80	0.031