

ROHS

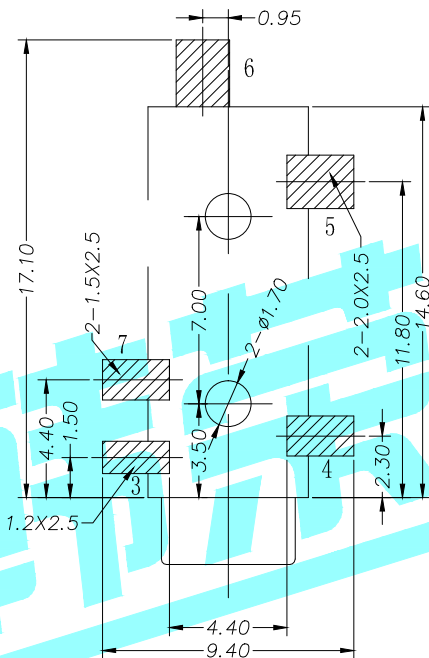

P.C.B Layout (copper-sided view)

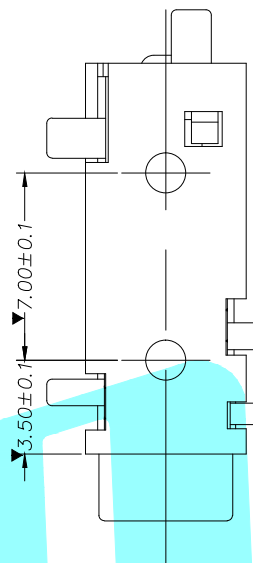
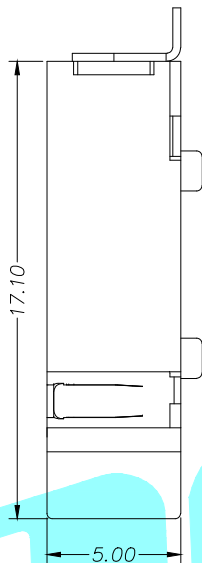
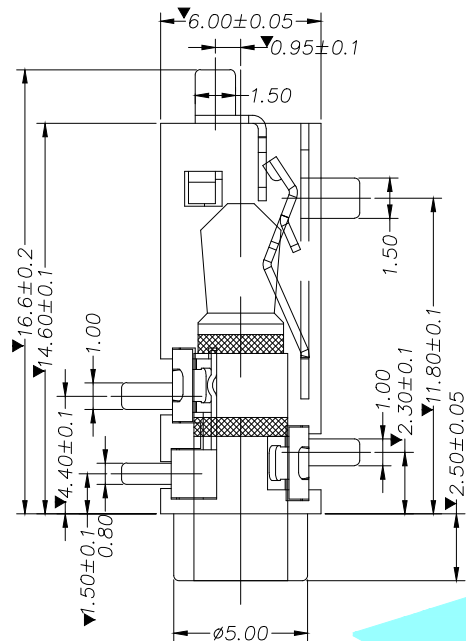
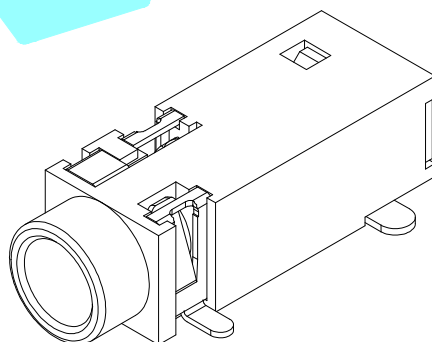
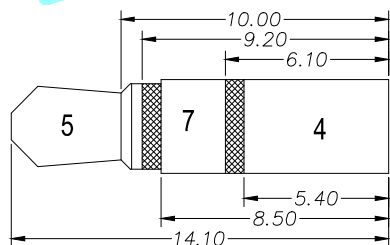
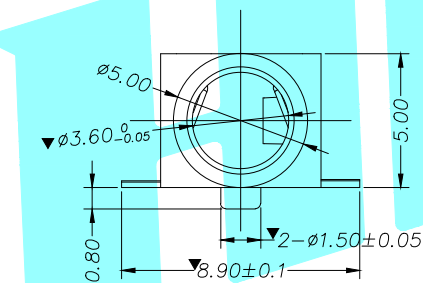

Model NO	PJ-328-5A
Schematic	

Rating:0.5A 30V DC
 Contact Resistance:100 mΩ Max.
 Operating temperature:-20℃~70℃
 Operating force:3-20N
 Operating Life:5,000cycles

②	Terminal	4	Phosphor bronze	Ag Plating		
①	Housing	1	PPA	Black		
ITEM	PART NAME	TER'NO.	QTY.	MATERIAL	FINISHING	REMARK

APPROVALS		DATE		 HRO ELECTRONICS CO.,LTD					
DRAWN	J.X.Zhang	2013/11/11					TITLE:	PHONE JACKS	
CHECKED				PART NO.	PJ-328-5A				
APPROVALS				TOLERANCES ARE	30~以上 ±0.30 10~30 ±0.20 5~10 ±0.15 ~ 5 ±0.10	ANGLE ±2°	UNIT: mm	SCALE: 1:1	PROJ:
ECN NO.	REV.	DATE.	DESCRIPTION.	CHANGE.	CHECK.	APPRO.	DRAWING NO.		SHEET 1 OF 1

ECN NO.	REV.	DATE.	DESCRIPTION.	CHANGE.	CHECK.	APPRO.
	A		NEW			