

## Features

- Ultra small package: 1.0x0.6x0.5mm
- Ultra low capacitance: 10pF max
- Ultra low leakage: nA level
- Low operating voltage:  $\pm 5V$
- Low clamping voltage
- 2-pin leadless package
- Complies with following standards:
  - – IEC 61000-4-2 (ESD) immunity test
    - Air discharge:  $\pm 30kV$
    - Contact discharge:  $\pm 30kV$
  - – IEC61000-4-5 (Lightning) 7A (8/20  $\mu s$ )
- RoHS Compliant

## Mechanical Characteristics

- Package: DFN1006-2 (0402)
- Lead Finish: Matte Tin
- Case Material: "Green" Molding Compound.
- Moisture Sensitivity: Level 3 per J-STD-020
- Terminal Connections: See Diagram Below
- Shipping Qty : 12000pcs/7Inch Tape & Reel

## Applications

- Smart Phone and Tablet PC
- TV and Set Top Box
- Wearable Devices
- PDA

## Ordering Information

Part Number	Qty per Reel	Reel Size
AZ5725-01F-P	12000	7"

## Dimensions and Pin Configuration

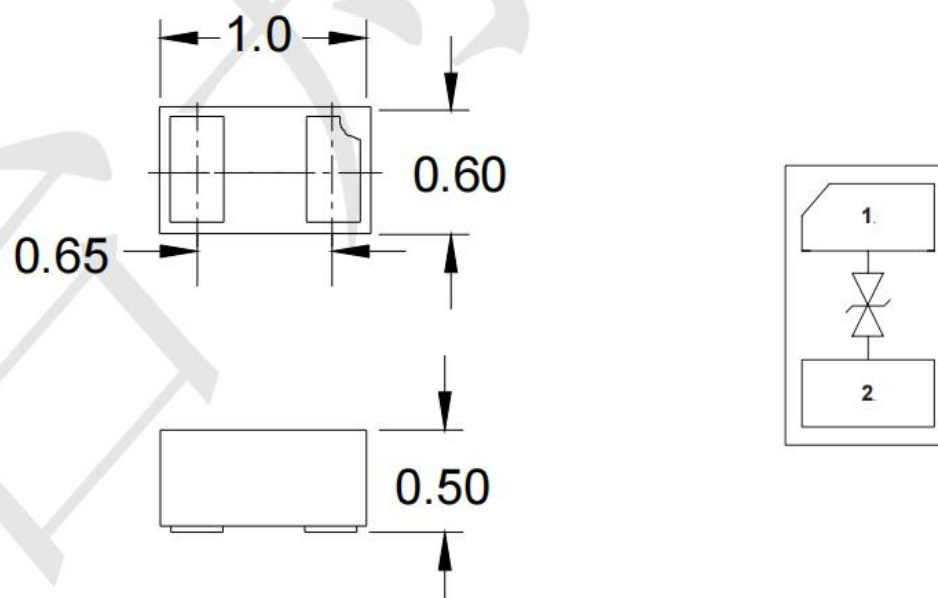

Marking:

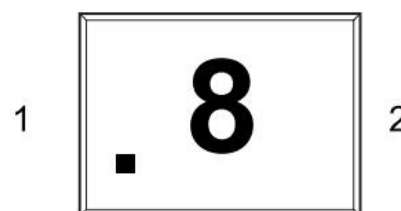

**Absolute Maximum Ratings** (Tamb=25°C unless otherwise specified)

Parameter	Symbol	Value	Unit
Peak Pulse Power (8/20μs)	Ppk	75	W
Peak Pulse Current (8/20μs)	Ipp	7	A
ESD per IEC 61000-4-2 (Air)	VESD	±30	kV
ESD per IEC 61000-4-2 (Contact)		±30	
Operating Temperature Range	TJ	-55 to +125	°C
Storage Temperature Range	Tstg	-55 to +150	°C

Symbol	Parameter
V <sub>RWM</sub>	Nominal Reverse Working Voltage
I <sub>R</sub>	Reverse Leakage Current @ V <sub>RWM</sub>
V <sub>tl</sub>	Trigger Voltage
I <sub>tl</sub>	Trigger Current @ V <sub>tl</sub>
V <sub>h</sub>	Holding Voltage
I <sub>h</sub>	Holding Current @ V <sub>h</sub>
V <sub>C</sub>	Clamping Voltage @ I <sub>pp</sub>
I <sub>pp</sub>	Maximum Peak Pulse Current
V <sub>F</sub>	Forward Voltage @ I <sub>F</sub>
C <sub>ESD</sub>	Parasitic Capacitance

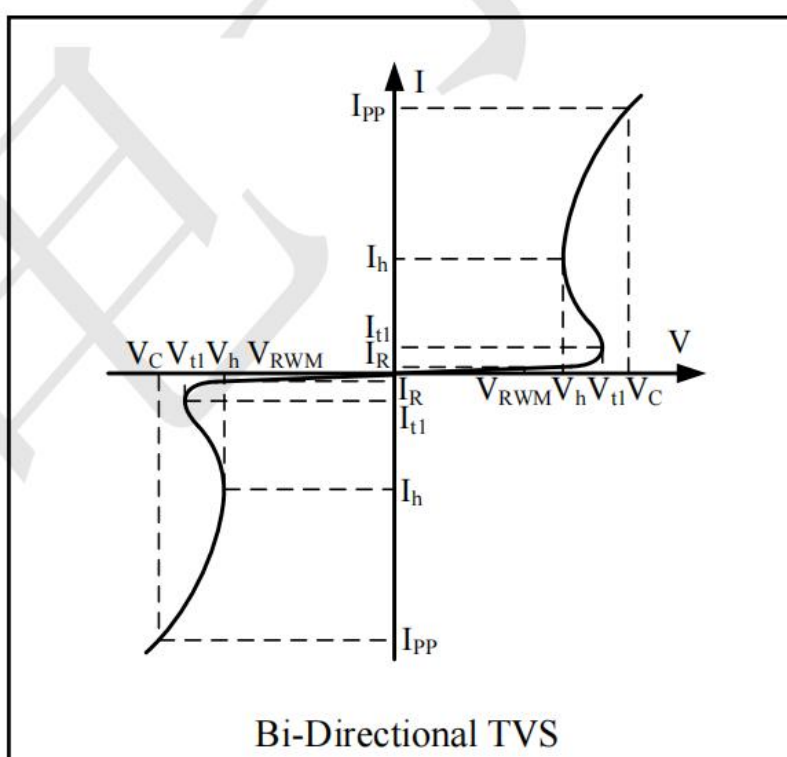

**Electrical Characteristics** (TA=25°C unless otherwise specified)

Parameter	Symbol	Min	Typ	Max	Unit	Test Condition
Reverse Working Voltage	V <sub>RWM</sub>			5	V	
Breakdown Voltage	V <sub>BR</sub>	5.8			V	I <sub>T</sub> = 1mA
Reverse Holding Voltage	V <sub>H</sub>	5.5			V	I <sub>H</sub> = 1mA
Reverse Leakage Current	I <sub>R</sub>			0.2	μA	V <sub>RWM</sub> = 5V
Clamping Voltage	V <sub>C</sub>			9	V	I <sub>pp</sub> =1A(8x 20us pulse)
Clamping Voltage	V <sub>C</sub>		15		V	I <sub>pp</sub> =7A(8x 20us pulse)
Junction Capacitance	C <sub>J</sub>		9	10	pF	V <sub>R</sub> = 0V, f = 1MHz



**Typical Performance Characteristics ( $T_A=25^{\circ}\text{C}$  unless otherwise Specified)**

**Fig1. 8/20 $\mu\text{s}$  Pulse Waveform**

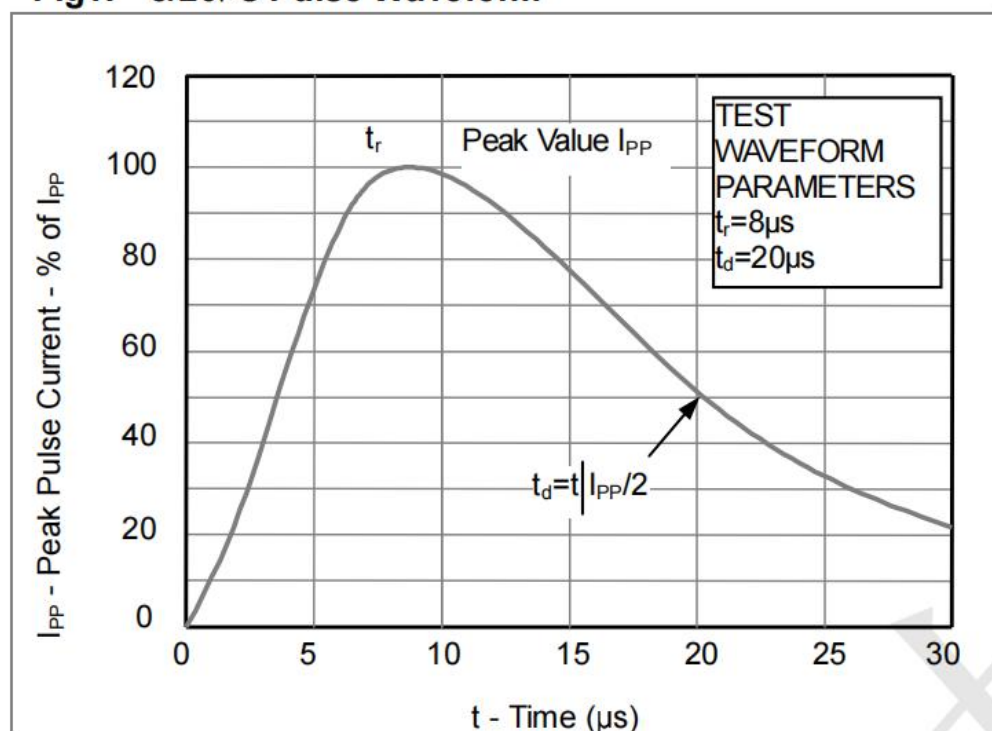

**Fig2. ESD Pulse Waveform (according to IEC 61000-4-2)**

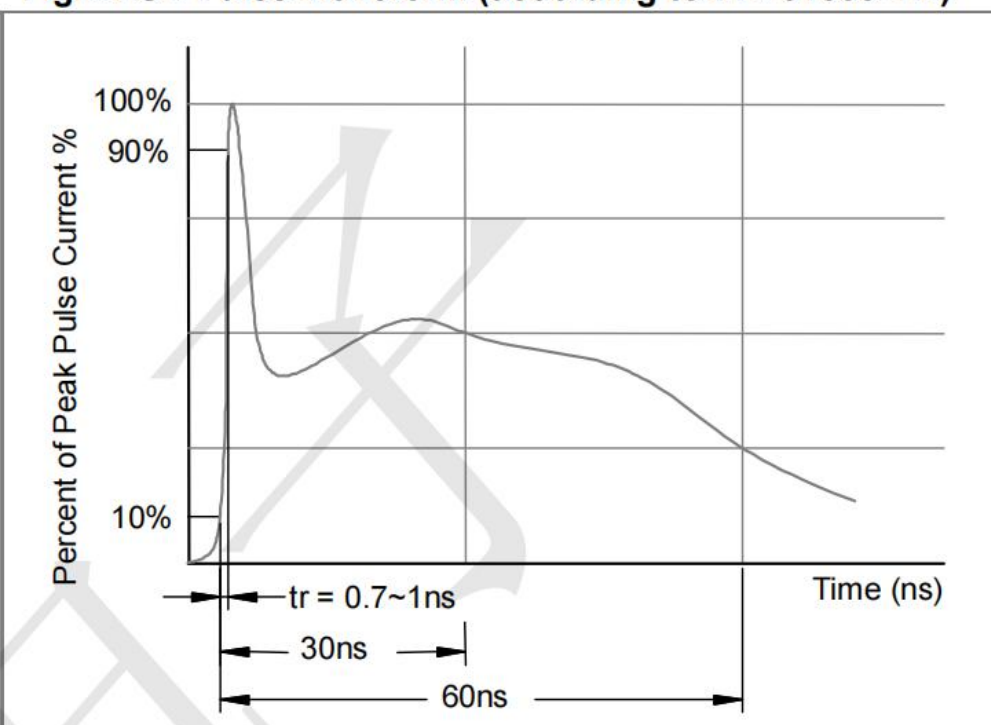

**Fig3. Power Derating Curve**

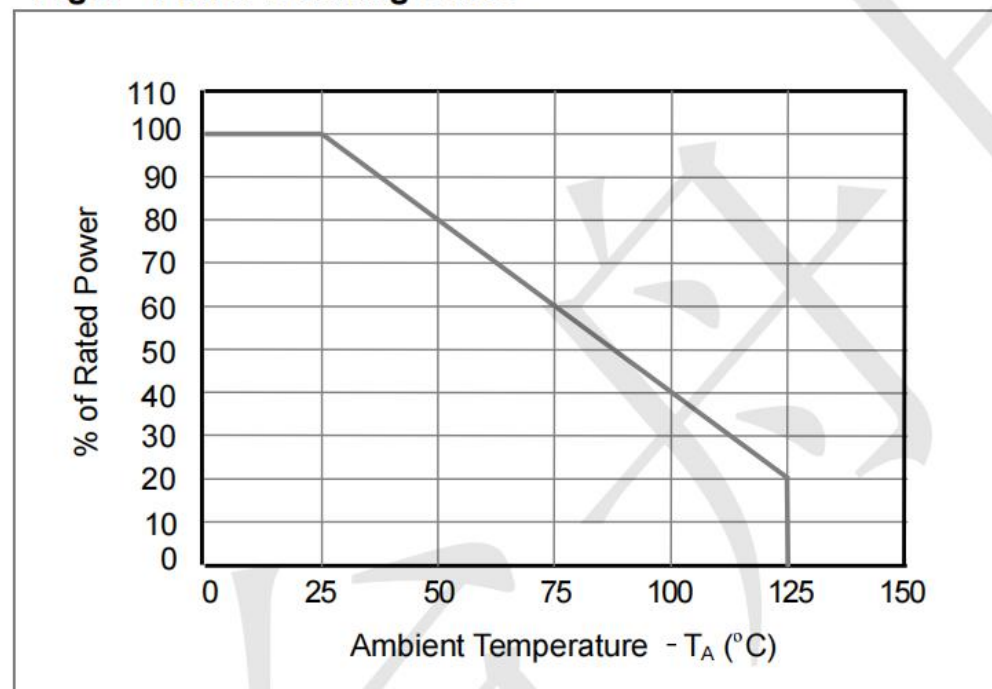

**DFN1006-2 Package Outline Drawing (0402)**

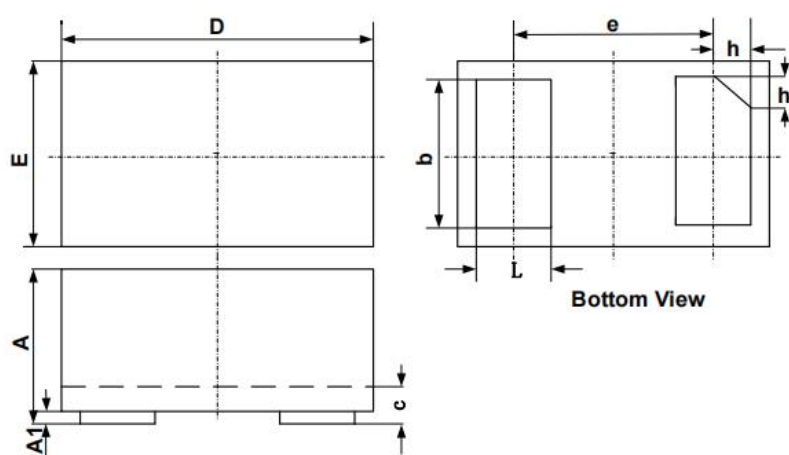

SYM	DIMENSIONS					
	MILLIMETERS			INCHES		
	MIN	NOM	MAX	MIN	NOM	MAX
A	0.45	0.50	0.55	0.018	0.020	0.022
A1	0.00	0.02	0.05	0.000	0.001	0.002
b	0.45	0.50	0.55	0.018	0.020	0.022
c	0.12	0.15	0.18	0.005	0.006	0.007
D	0.95	1.00	1.05	0.037	0.039	0.041
e	0.65 BSC			0.026 BSC		
E	0.55	0.60	0.65	0.022	0.024	0.026
L	0.20	0.25	0.30	0.008	0.010	0.012
h	0.07	0.12	0.17	0.003	0.005	0.007

**Suggested Land Pattern**

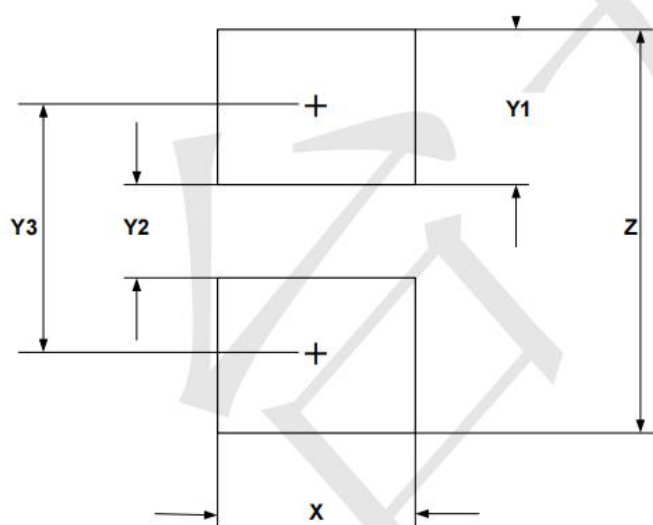

SYM	DIMENSIONS	
	MILLIMETERS	INCHES
X	0.60	0.024
Y1	0.50	0.020
Y2	0.30	0.012
Y3	0.80	0.032
Z	1.30	0.052