

Version	ECM	Amendments	Modifier	Date Modified
A/0				

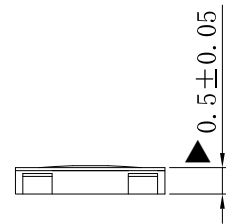

此处不可出现露筋现象

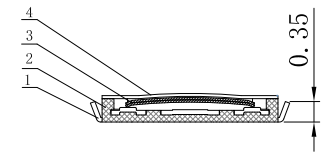
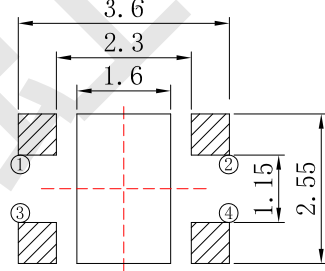
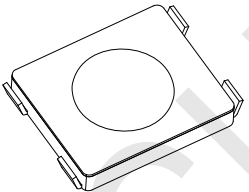
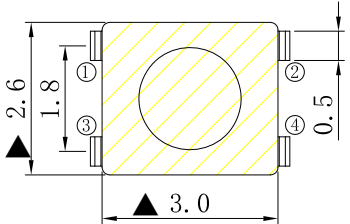
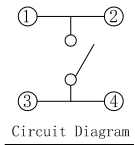
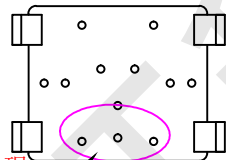

P. C. B. Layout

- Remarks:
1. Rated current, Voltage: DC 12V 50mA
  2. Contact resistance:  $\leq 100m\Omega$
  3. Insulation resistance:  $\geq 100M\Omega$
  4. The intensity of operations:  $200 \pm 50gf$
  5. Life requirements: 100000 times
  6. Withstand voltage: AC250V 1 minute
  7. All materials comply with RoHS standards

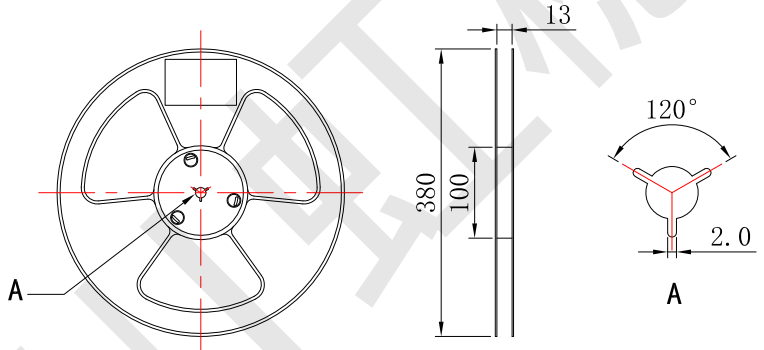
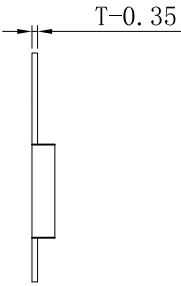
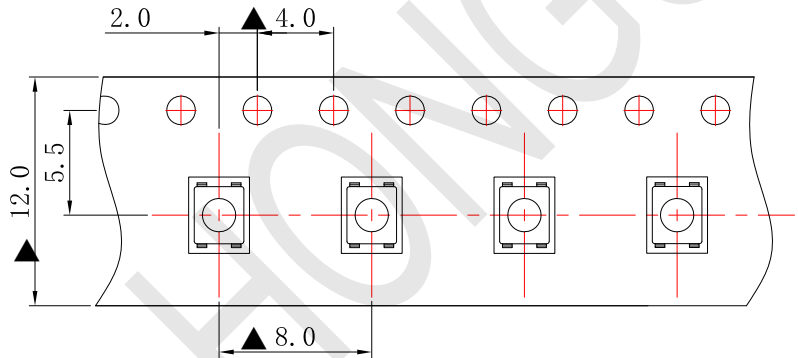

- Remarks:
- 1, The number of tapes per volume is 10000 PCS;
  - 2, Braiding process, can not be caused by carrying half crushed;
  - 3, Pay attention to the direction of the tape, with a clockwise direction out of the carrier tape, with a hole in the top or right

NO.	PART NAME	MATERIAL	QTY	FINISHING	General Tolerance		DRAWN			Product Name	
					X ≤ 1	±0.05	AFFIRM	YANGBIAO	YANGGUOQUAN	Model Number	Tact switch
4	Paster	Polyimide	1	Yellow	1 ≤ X ≤ 5	±0.10	AUDITING			DATE	2016-06-08
3	Shrapnel	SUS	2	Ag Plating	X > 10	±0.25	SHEET	1:1	UNIT	mm	
2	Housing	LCP	1	Black	ANGLE	±3°					
1	Terminal	Phosphor copper	4	Ag Plating							
Zhejiang Hongsui Precision Electronics Co., Ltd.											