

YTS-F002-X系列

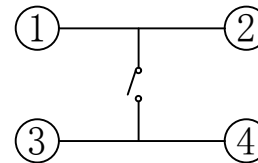

H	H
4.3	4.5
5.0	5.5
6.0	6.5
.....
18.0	18.5
19.0	19.5

电路图
CIRCUIT DIAGRAM

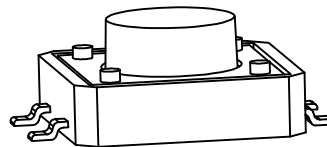
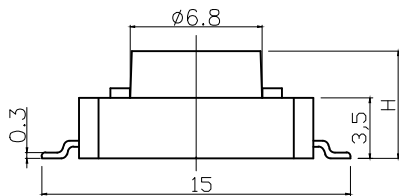
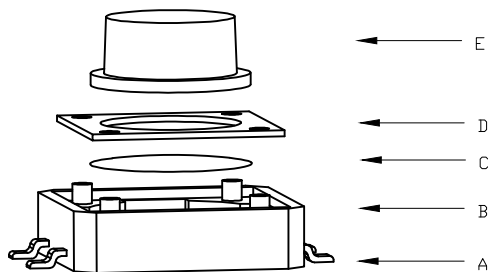
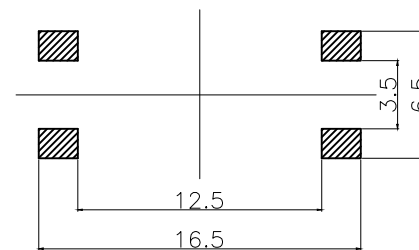
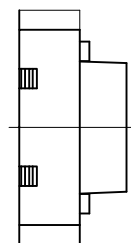
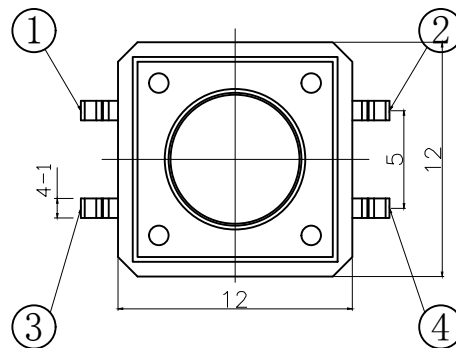

PCB. 焊接图
PCB. WELDING DRAWING

主要技术参数、性能

The Main Thchnology Performance

额定电流、电压 Rate voltage. current	50mA DC12V
接触电阻 Contact resistance	≤100mΩ
按力 Operating force	见编码表
行程 travel	0.30±0.10mm
绝缘电阻 Insulated resistance	≥100MΩ
介电强度 Dielectric strength	≥250VAC/1min
寿命 Endurance	≥30000次

编码表

YFTS	E006	X	XXX	XX	XX	X
开关	型号	等级	高度	克力	另码	包装
		A	4.3mm 4.5mm	180gf	01~99	A散装
		B	5.0mm 5.5mm	250gf		B冷封编带
			6.0mm 6.5mm			C管热
			18.0mm 18.5mm			H热封
			19.0mm 19.5mm			

E	按钮	PPA	1	黑色
D	盖板	铁盖板	1	镀铜锡
C	弹片	磷铜	1	镀银
B	本体	PPA	1	黑色
A	卡件	黄铜	1	镀银
项目 ITEM	名称 DESCRIPTION	材质 MATERIAL	数量 QTY	表面处理/颜色 FINSH/COLOR

					第一视角 FIRST VIEW			
标记 SING	处数 FREQUENCY	更改文件号 REVISION	签名 APPROVED	日期 DATE	比例 SCALE	1:1	一般公差 GENERAL TOLERANCE	
设计 DESIGN	赵晓峰		2017.05.17		单位 UNIT	mm	0.5~2	±0.10
审核 CHECKED	陈乐峰		2017.05.17		重量 WEIGHT		2~5	±0.25
批准 APPROVED	朱旭静		2017.05.17				5~10	±0.30
							角度 ANGLE	±0.5°

名称/NAME:
轻触开关
TACTILE SWITCH

型号/MODEL:
YTS-F002-X系列

东莞市博众电气有限公司
DONGGUAN BOZHONG ELECTRONIC CO.,LTD.