

LPB2305LT1G

30V P-Channel Enhancement-Mode MOSFET

1. FEATURES

- $V_{DS} = -30V$
- $R_{DS(ON)}, V_{GS}@-10V, I_{DS}@-4.2A \leq 70m\Omega$
- $R_{DS(ON)}, V_{GS}@-4.5V, I_{DS}@-4.0A \leq 85m\Omega$
- $R_{DS(ON)}, V_{GS}@-2.5V, I_{DS}@-1.0A \leq 130m\Omega$
- We declare that the material of product compliance with RoHS requirements and Halogen Free.

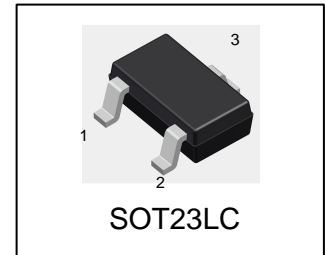

2. APPLICATIONS

- Advanced trench process technology
- High density cell design for ultra low on-resistance.

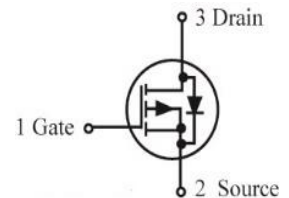

3. DEVICE MARKING AND ORDERING INFORMATION

Device	Marking	Shipping
LPB2305LT1G	P05	3000/Tape&Reel
LPB2305LT3G	P05	10000/Tape&Reel

4. MAXIMUM RATINGS($T_a = 25^\circ C$)

Parameter	Symbol	Limits	Unit
Drain–Source Voltage	V_{DSS}	-30	V
Gate–to–Source Voltage – Continuous	V_{GS}	± 14	V
Drain Current			A
– Continuous $T_A = 25^\circ C$	I_D	-4.2	
– Pulsed (Note 1)	I_{DM}	-30	

5. THERMAL CHARACTERISTICS

Parameter	Symbol	Limits	Unit
Power Dissipation	PD	1.4	W
Thermal Resistance, Junction–to–Ambient(Note 2)	$R_{\theta JA}$	140	$^\circ C/W$
Junction and Storage temperature	T_J, T_{stg}	$-55 \sim +150$	$^\circ C$

1.Repetitive Rating: Pulse width limited by the maximum junction temperature.

2.1-in² 2oz Cu PCB board.

6. ELECTRICAL CHARACTERISTICS (Ta= 25°C)

Characteristic	Symbol	Min.	Typ.	Max.	Unit	
Static						
Drain-Source Voltage (ID = -250μA, VGS = 0V)	V(BR)DSS	-30	-	-	V	
Zero Gate Voltage Drain Current (VDS = -24V, VGS = 0V)	IDSS	-	-	-1	μA	
Gate-body Leakage Current (VDS = 0V, VGS = ± 14V)	IGSS	-	-	±100	nA	
Gate Threshold Voltage (VDS = VGS, ID = -250μA)	VGS(th)	-0.7	-	-1.3	V	
Static Drain-Source On resistance (VGS = -10V, ID = -4.2A) (VGS = -4.5V, ID = -4A) (VGS = -4.5V, ID = -4A)	RDS(ON)		53 64 86	70 85 130	mΩ	
Diode Forward Voltage (IS = -1A, VGS = 0V)	VSD	-	-	-1	V	
Dynamic						
Input Capacitance	(VDS = -15V, VGS = 0V, f = 1MHz)	Ciss	-	826.18	-	pF
Output Capacitance		Coss	-	90.74	-	
Reverse Transfer Capacitance		Crss	-	53.18	-	
Turn-On Delay Time	(VDD = -15V, RL = 3.6Ω, ID = -1A, VGEN = -10V, RG = 6Ω)	td(on)	-	11.36	-	ns
Turn-On Rise Time		tr	-	2.32	-	
Turn-Off Delay Time		td(off)	-	34.88	-	
Turn-Off Fall Time		tf	-	3.52	-	

7. ELECTRICAL CHARACTERISTICS CURVES

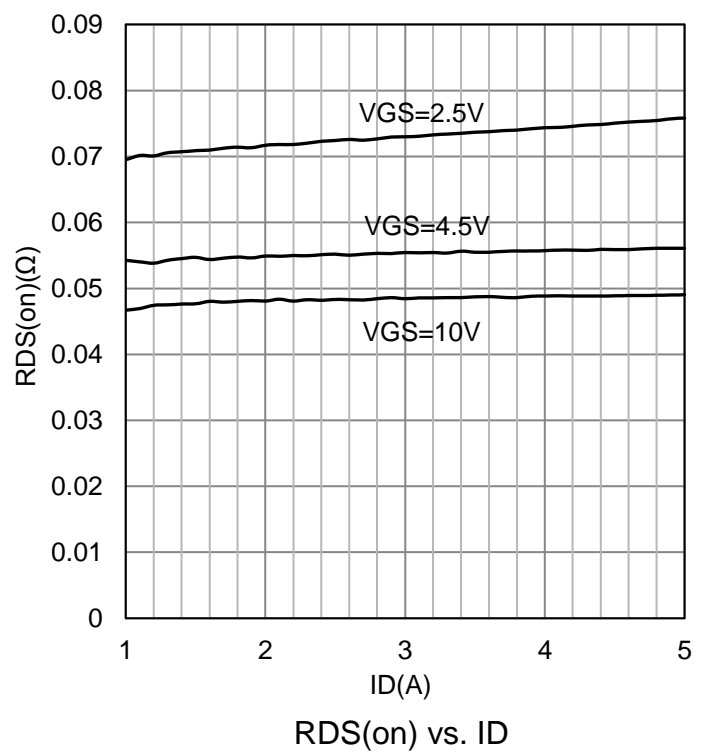
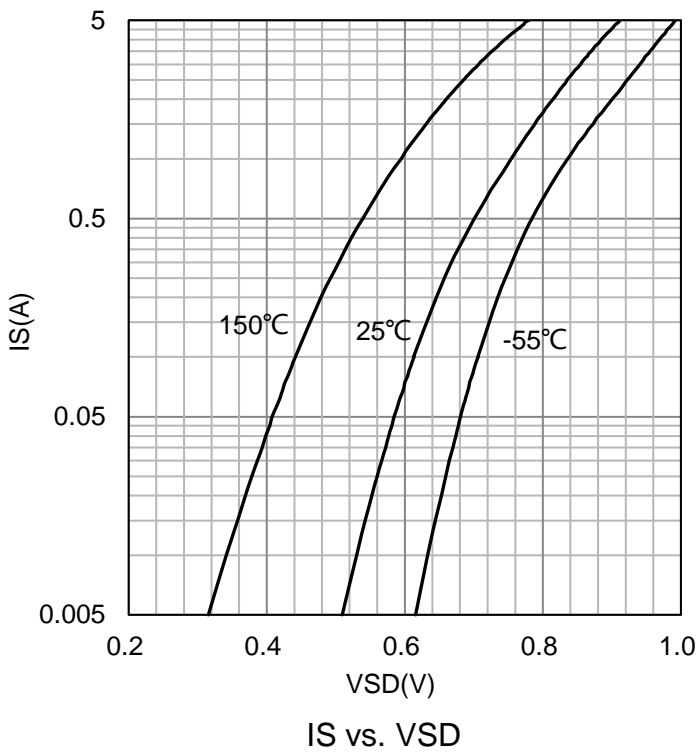
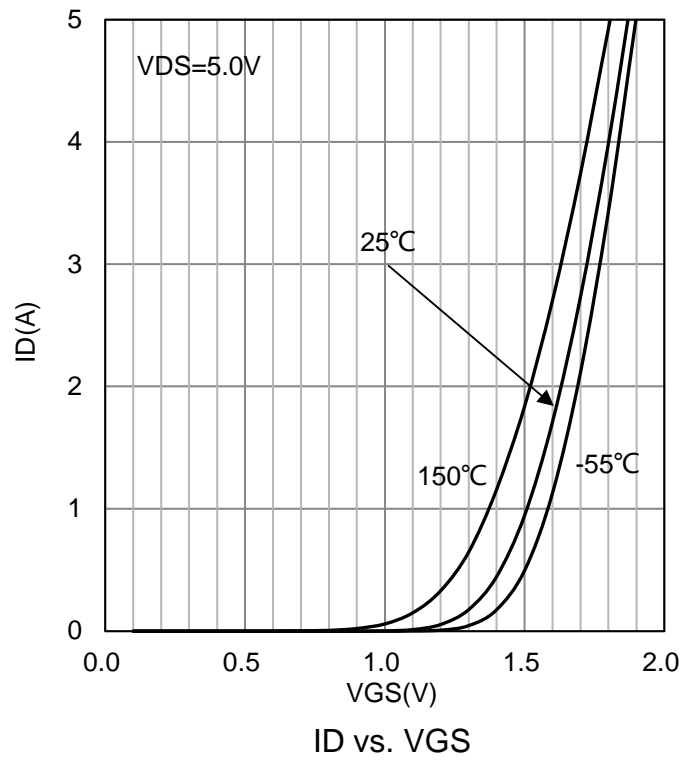
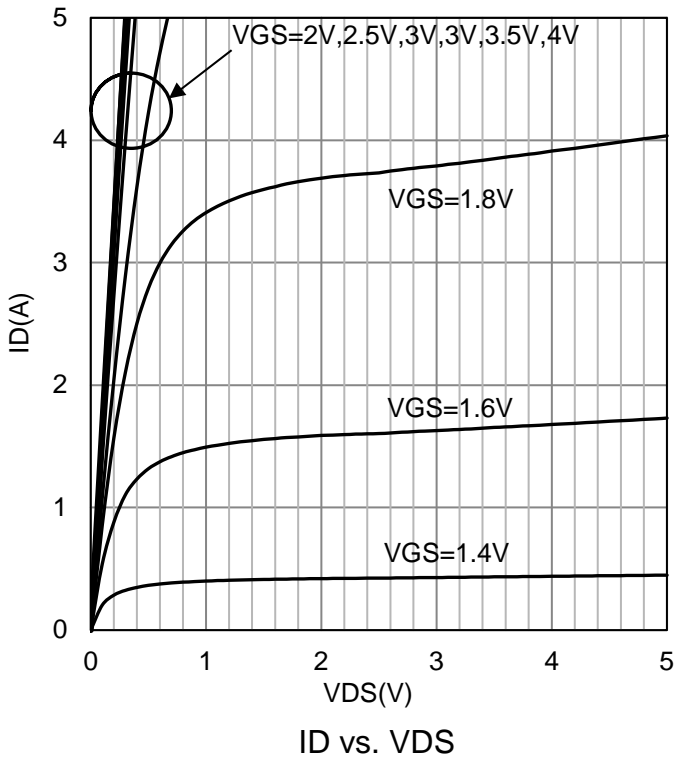

7. ELECTRICAL CHARACTERISTICS CURVES (Con.)

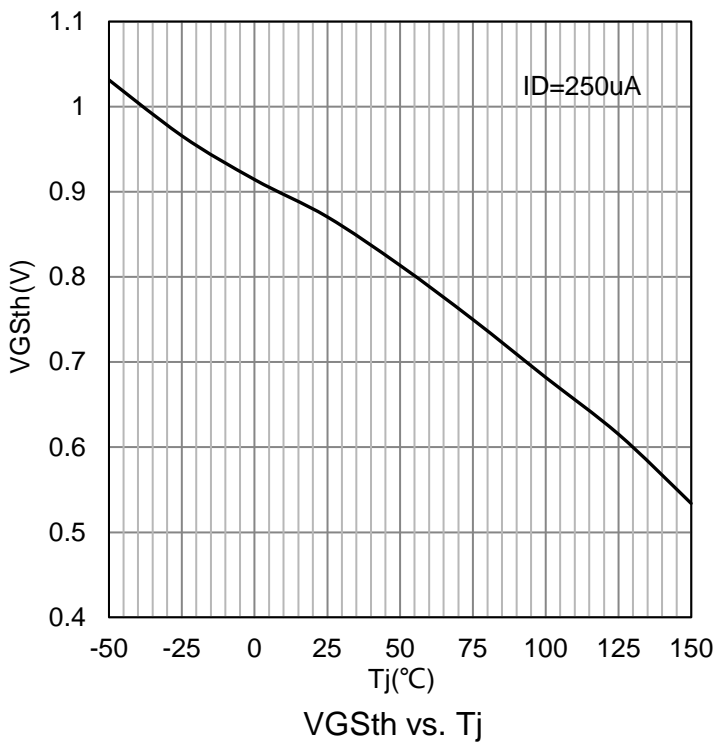
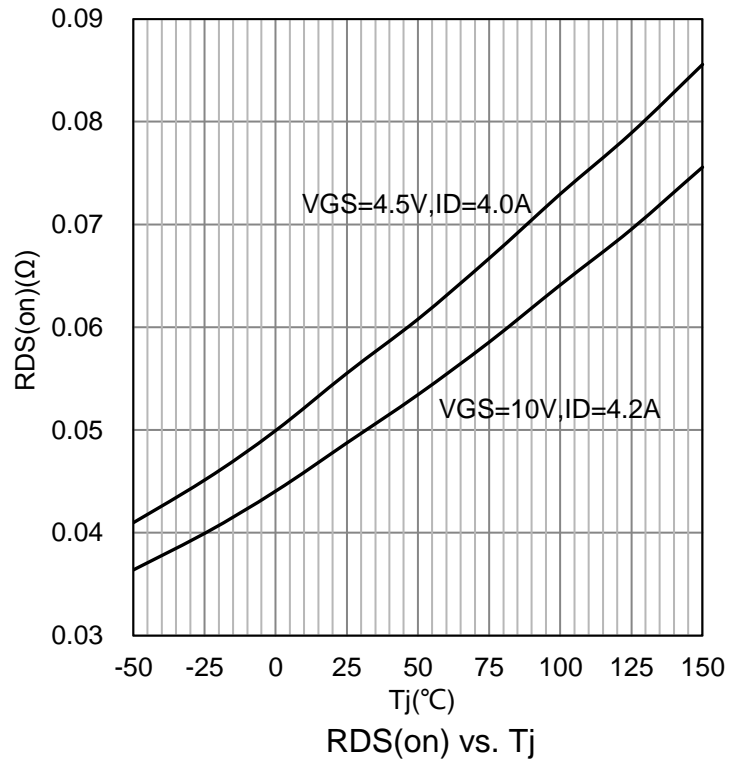
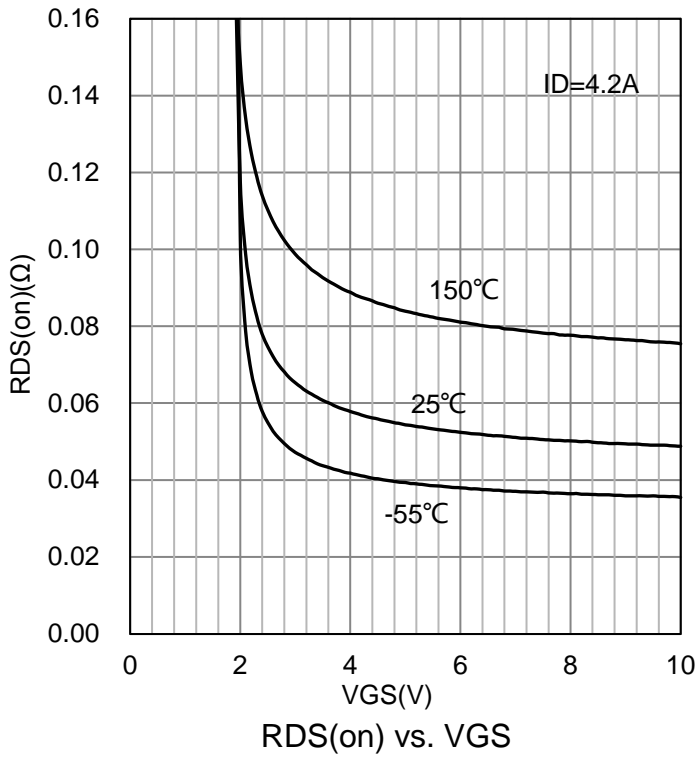

8. OUTLINE AND DIMENSIONS

SOT23LC

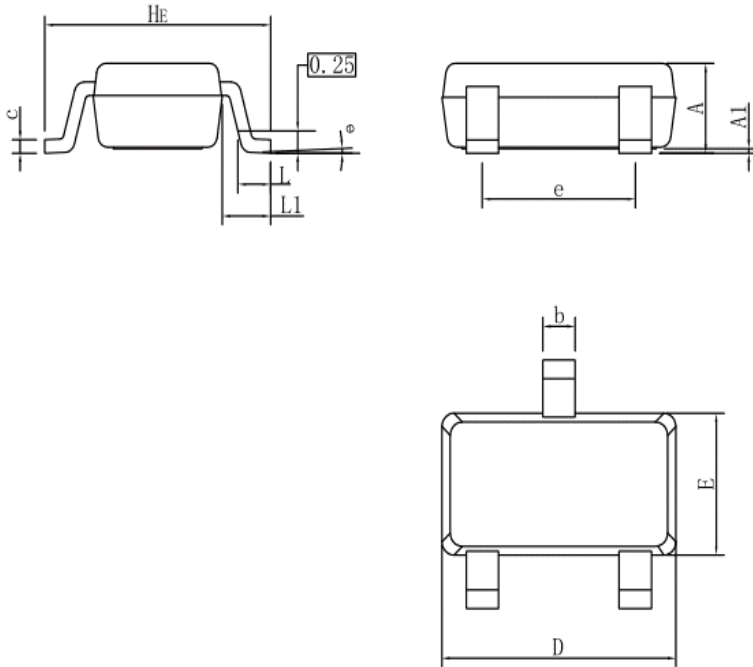

SOT23-LC			
DIM	MIN	NOR	MAX
A	0.90	1.00	1.10
A1	0.01	0.06	0.10
b	0.30	0.40	0.50
c	0.10	0.17	0.20
D	2.80	2.90	3.00
E	1.50	1.60	1.70
e	1.80	1.90	2.00
L	0.20	0.40	0.60
L1	0.60REF		
HE	2.60	2.80	3.00
θ	0°	-	10°
All Dimensions in mm			

GENERAL NOTES

1. Top package surface finish $Ra0.4 \pm 0.2 \mu m$
2. Bottom package surface finish $Ra0.7 \pm 0.2 \mu m$
3. Side package surface finish $Ra0.4 \pm 0.2 \mu m$

9. SOLDERING FOOTPRINT

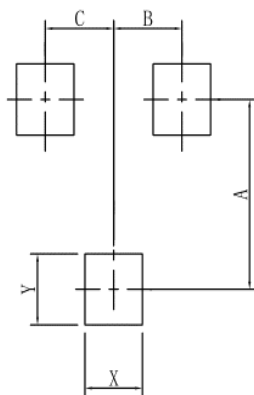

SOT23-LC	
DIM	(mm)
X	0.80
Y	0.90
A	2.40
B	0.95
C	0.95

DISCLAIMER

- Before you use our Products, you are requested to carefully read this document and fully understand its contents. LRC shall not be in any way responsible or liable for failure, malfunction or accident arising from the use of any LRC's Products against warning, caution or note contained in this document.
- All information contained in this document is current as of the issuing date and subject to change without any prior notice. Before purchasing or using LRC's Products, please confirm the latest information with a LRC sales representative.