

Inductor



Figure



Type A



Type B



Type C



Note: The image shown here is indicative only. If there is inconsistency between the image and the actual product, the actual product shall govern.

Specifications:

<i>SERIES : SKPC-ERFD25-XXX</i>	
Test Conditions:	25°C 10KHz 1V
Inductance :	25μH±5% (No Current)
Dimensions(L*W*H):	90*65*26mm
Pins and Connection	2*Terminals
Hi-Pot(Wire to Core)	1KV/3KV/5KV DC^①

Model	Type	DCR Max 20°C	Isat L drops 20% (Max)	Irms Temperature Rise 40°C (Max.) ^②	Weight (Max)
SKPC-ERFD25-3B(135)	B	2.5mΩ	20A	21A	341g
SKPC-ERFD25-4B(135)	B	3.4mΩ	34A	21A	351g
SKPC-ERFD25-5C(135)	C	1.6mΩ	45A	36A	463g
SKPC-ERFD25-6C(135)	C	1.5mΩ	57A	48A	555g
SKPC-ERFD25-7C(135)	C	2.2mΩ	68A	36A	524g
SKPC-ERFD25-8C(135)	C	2.6mΩ	79A	36A	555g
SKPC-ERFD25-9C(135)	C	4.7mΩ	89A	24A	494g
SKPC-ERFD25-10C(135)	C	5.1mΩ	100A	24A	494g
SKPC-ERFD25-11C(135)	C	5.7mΩ	112A	24A	494g
SKPC-ERFD25-12C(135)	C	6.1mΩ	122A	24A	494g
SKPC-ERFD25-13C(135)	C	6.6mΩ	134A	24A	514g

Inductor



Operating temperature: -40°C to +75°C

Note:

1. Classification of different Hi-Pot level : 1-1KVDC/3-3KVDC/5-5KVDC
2. Since different ways of heat dissipation affect Temperature rise, Temperature rise is reference.

Material List

No.	Item	Material Description
1	Core	Ferrite
2	Wire	Copper
3	Solder (Lead Free)	SnAg3%Cu
4	Insulation	Polyimide+Polyamide-imide Resin

Note: Temperature tolerance grade: H CLASS

Schematic Diagram

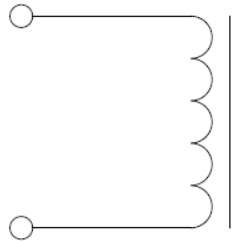

Configurations and Dimensions (mm)

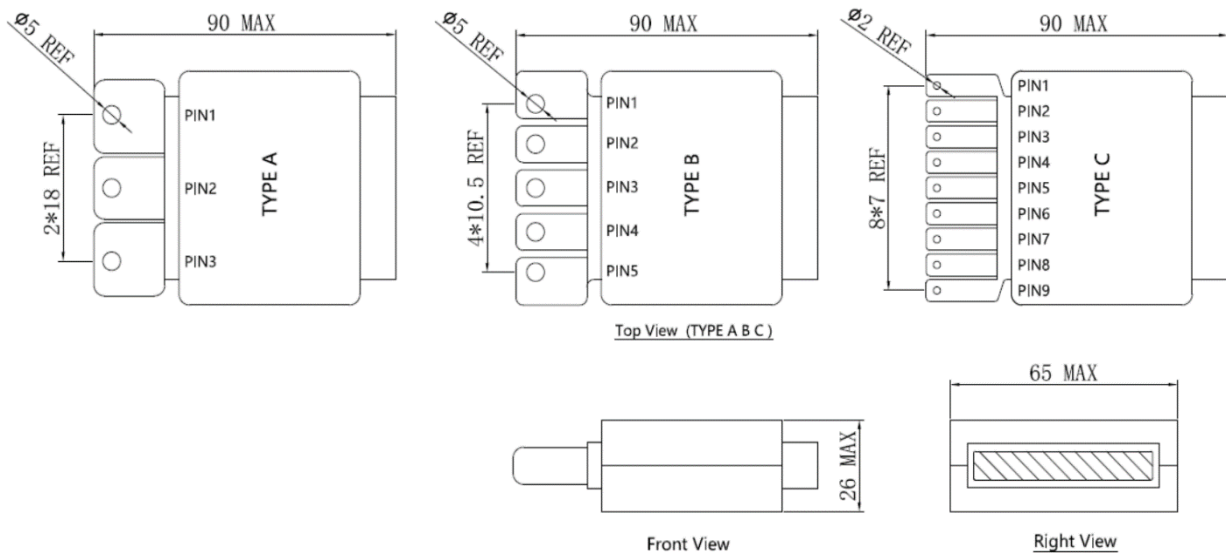

Inductor



Model.	Type	Description of pins
SKPC-ERFD25-3B(135)	B	PIN1+PIN4
SKPC-ERFD25-4B(135)	B	PIN1+PIN5
SKPC-ERFD25-5C(135)	C	PIN2+PIN7
SKPC-ERFD25-6C(135)	C	PIN2+PIN8
SKPC-ERFD25-7C(135)	C	PIN1+PIN8
SKPC-ERFD25-8C(135)	C	PIN1+PIN9
SKPC-ERFD25-9C(135)	C	PIN1+PIN8
SKPC-ERFD25-10C(135)	C	PIN1+PIN9
SKPC-ERFD25-11C(135)	C	PIN1+PIN8
SKPC-ERFD25-12C(135)	C	PIN1+PIN9
SKPC-ERFD25-13C(135)	C	PIN1+PIN8

L(uH) vs Frequency(KHz)

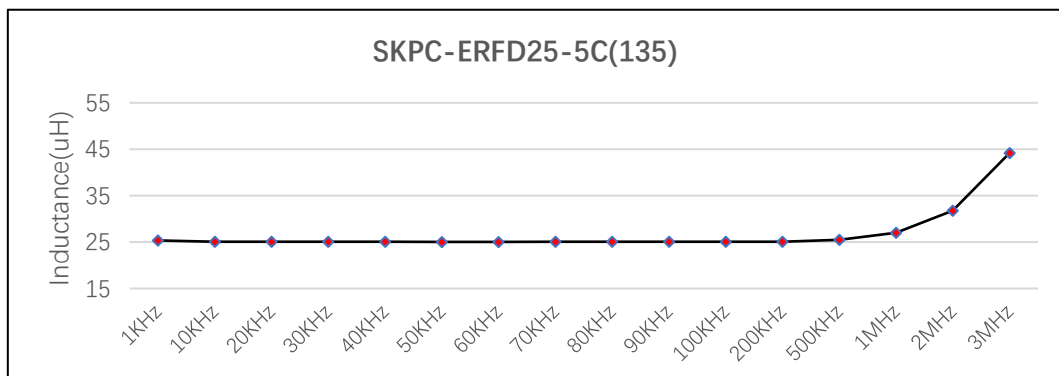
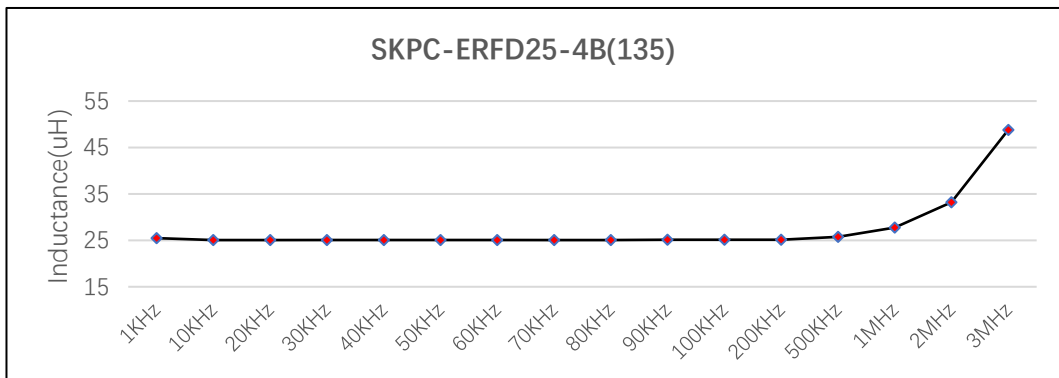
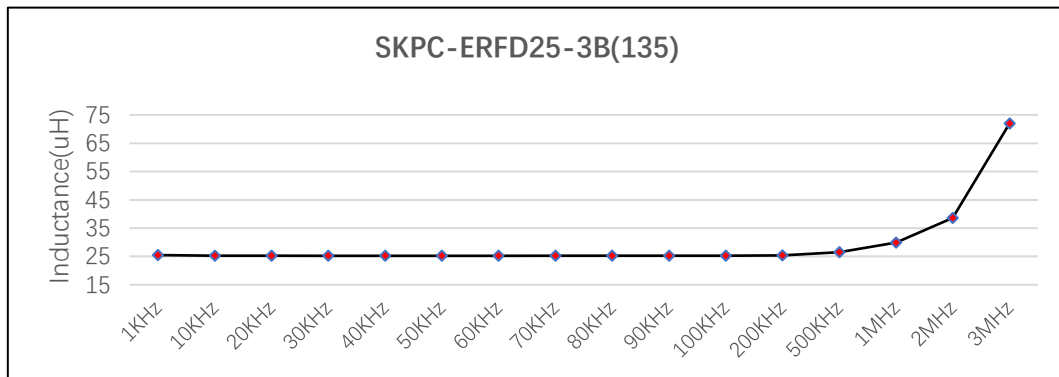

Inductor

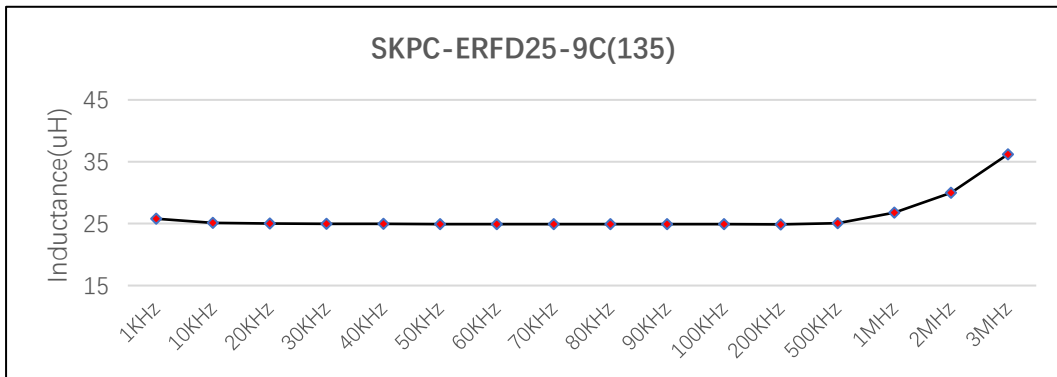
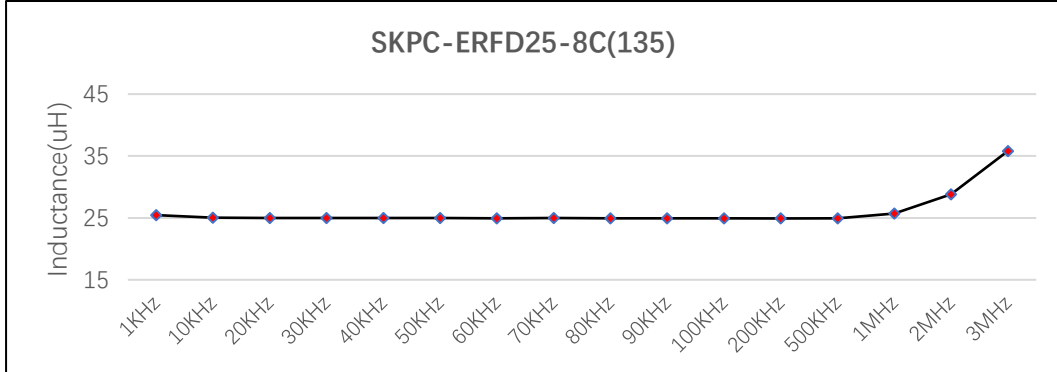
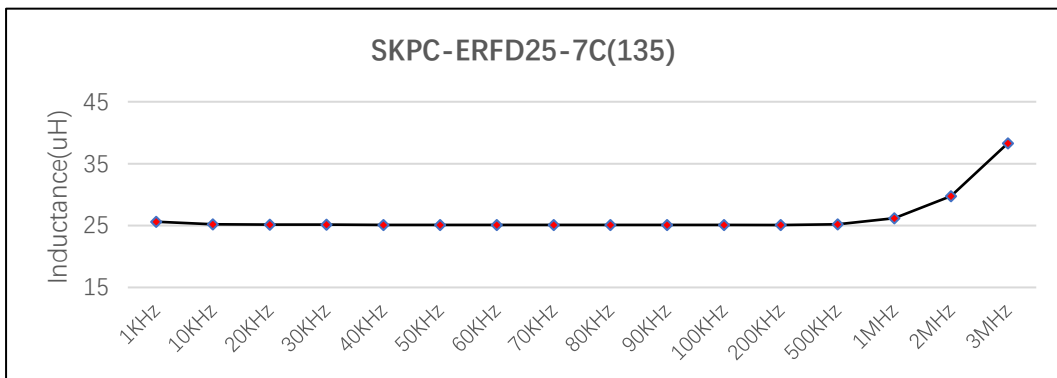
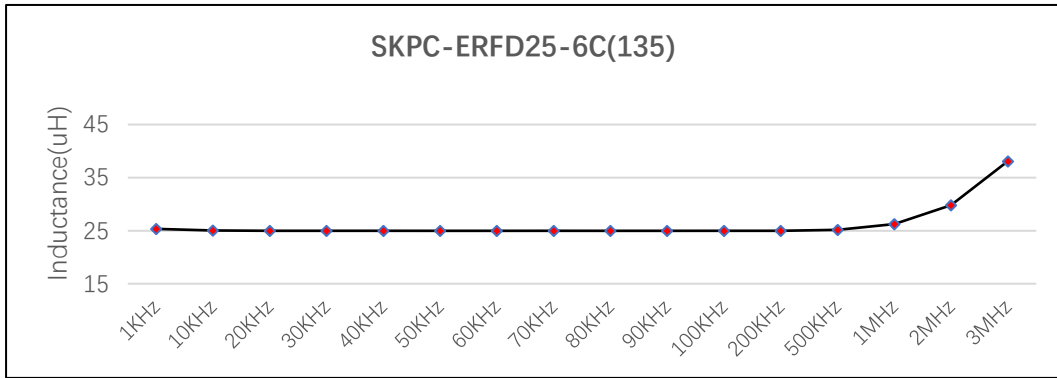

Inductor

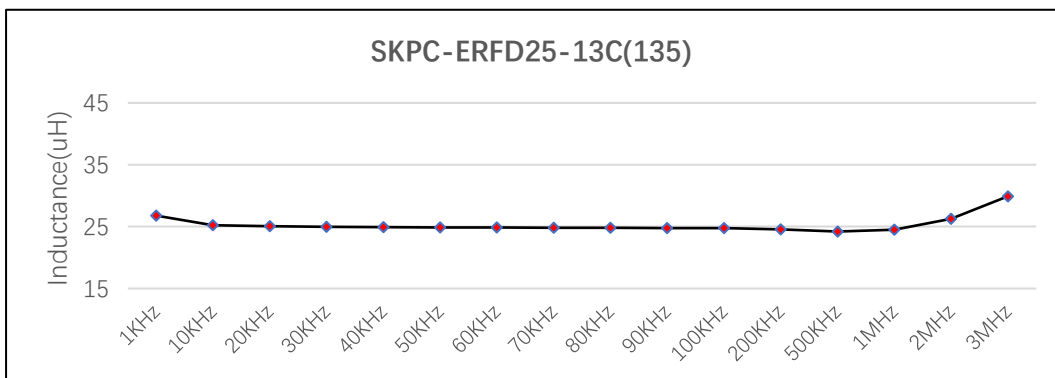
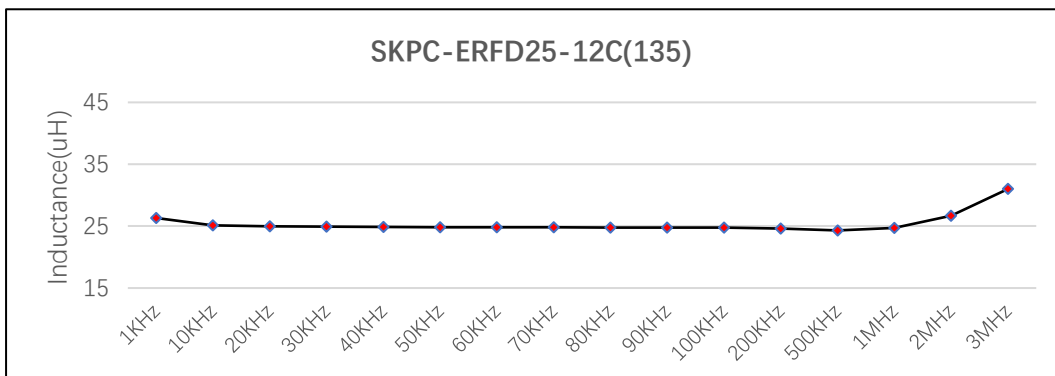
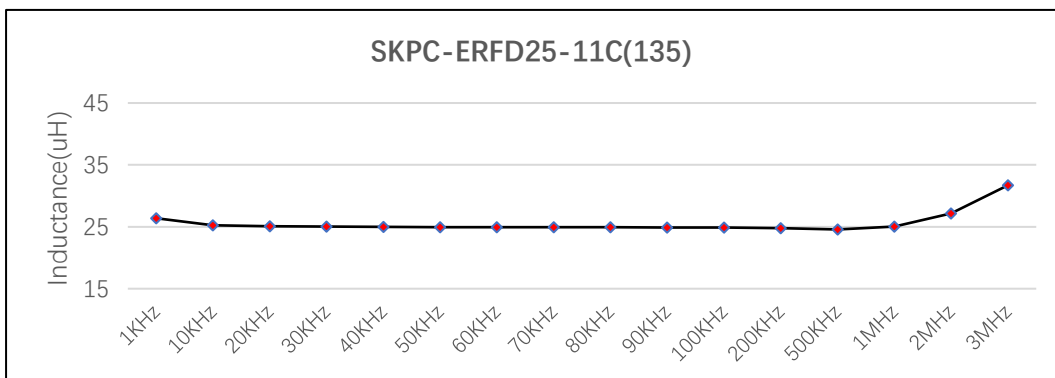
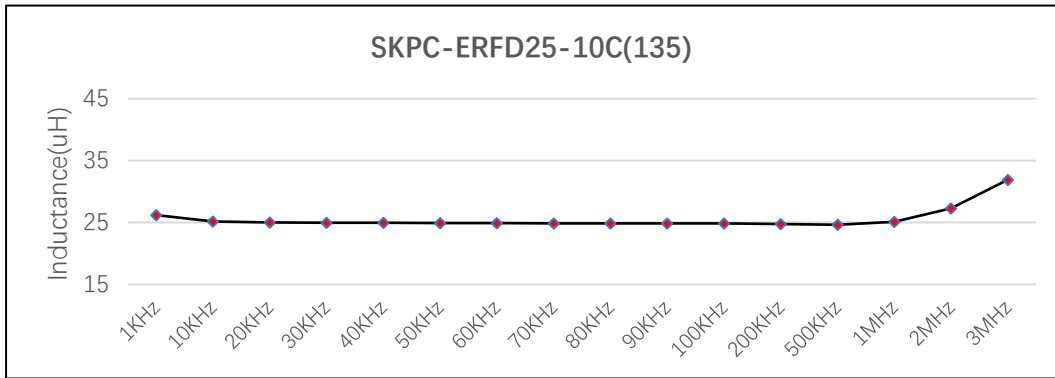

Note: This data is based on the WK-3260B.

Inductor



L(uH) vs Current(A)

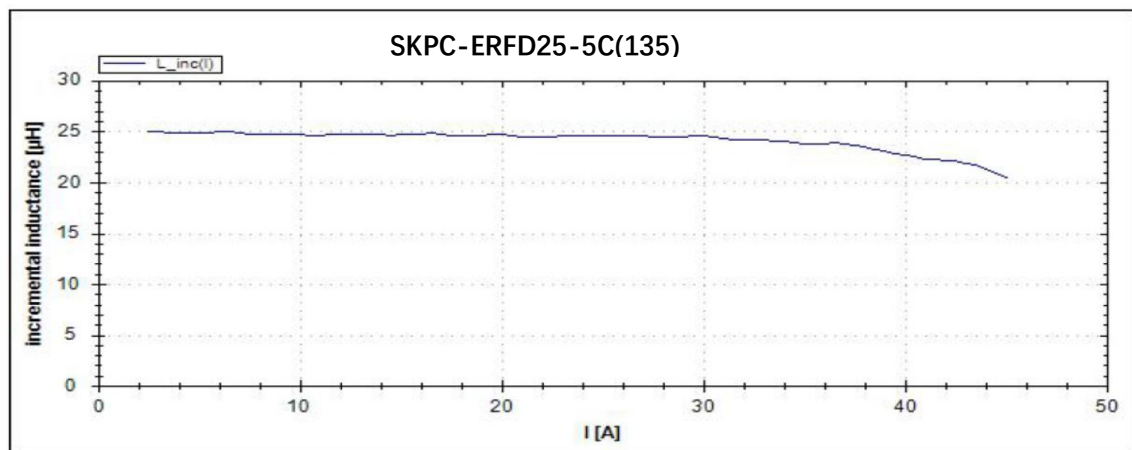
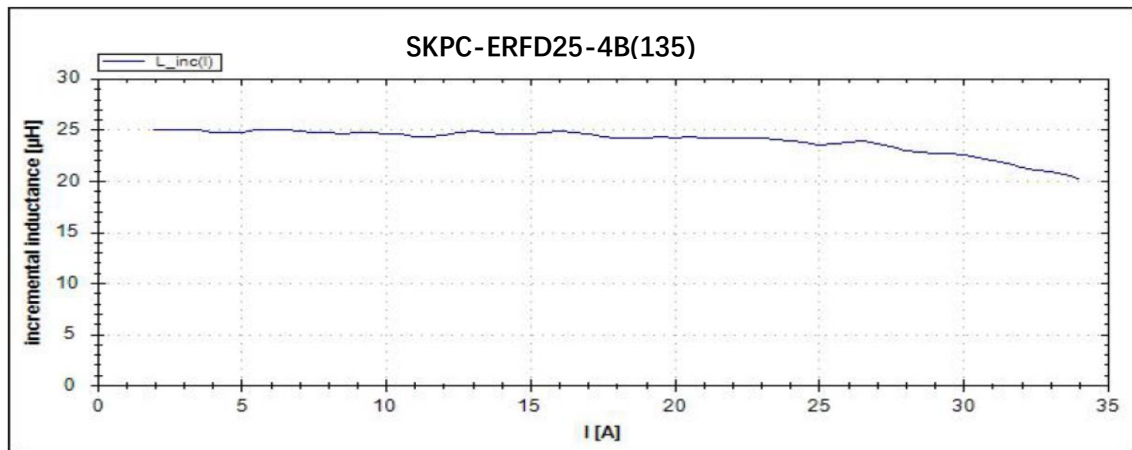
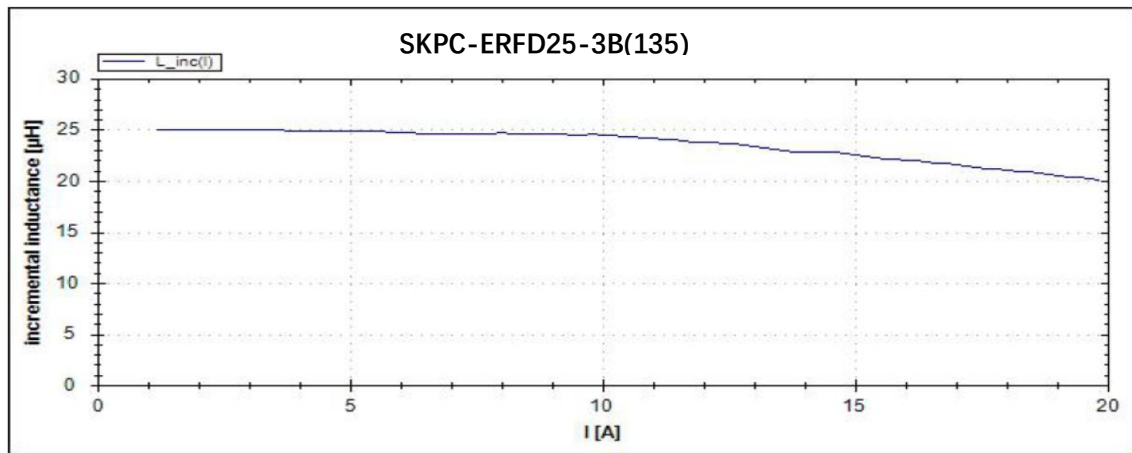

Inductor

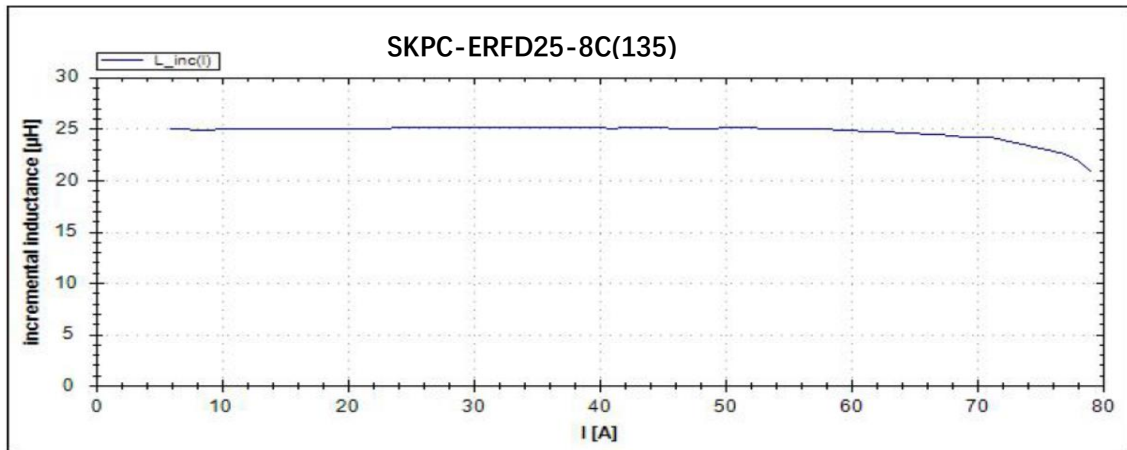
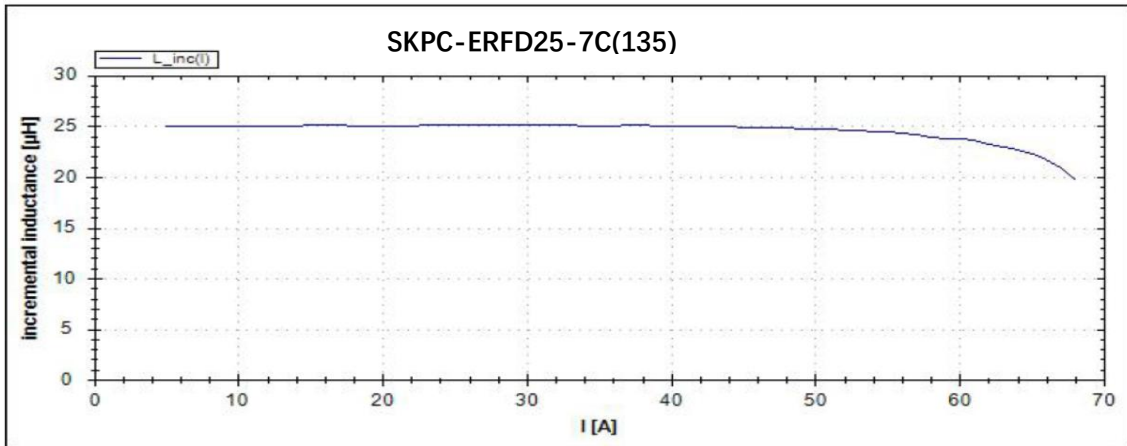
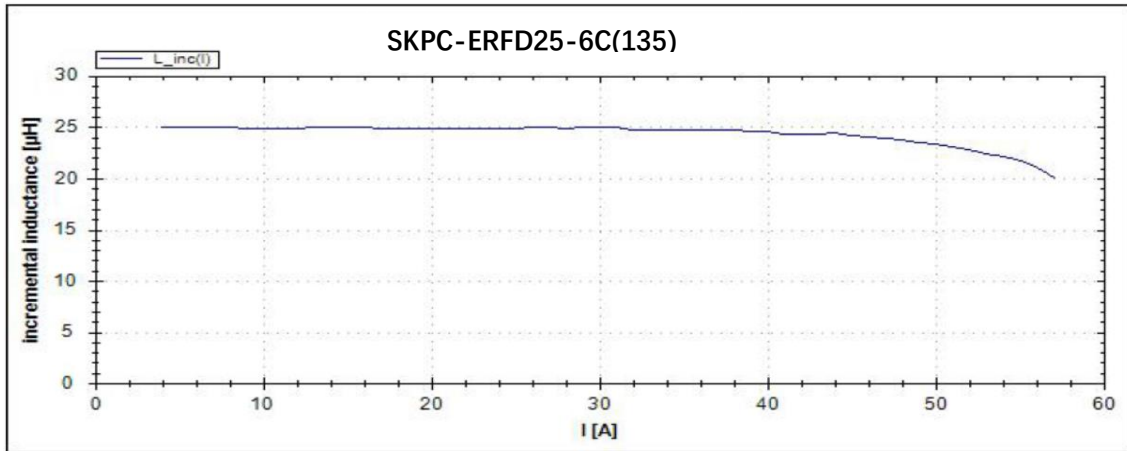

Inductor

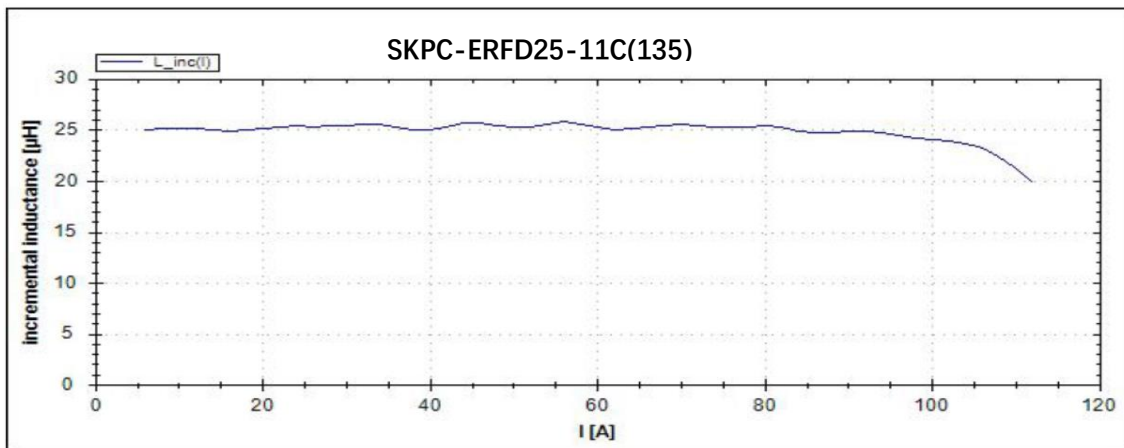
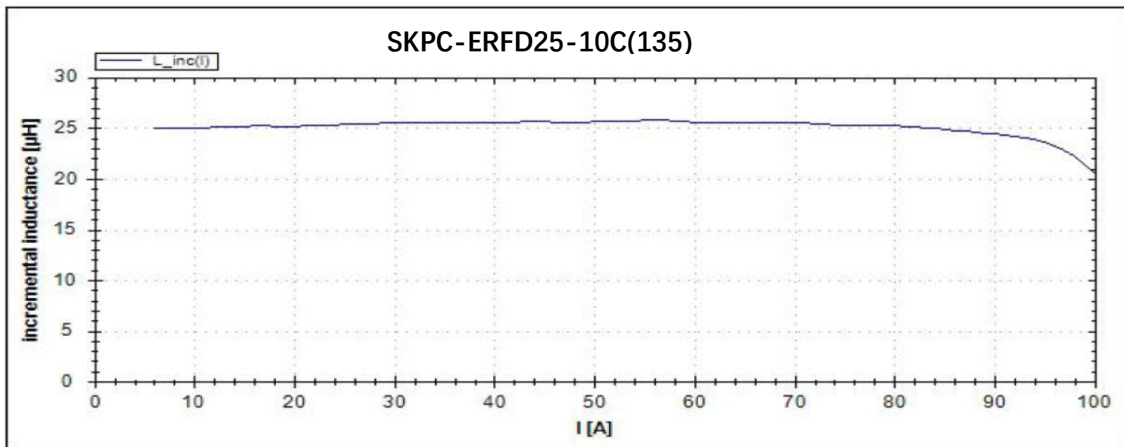
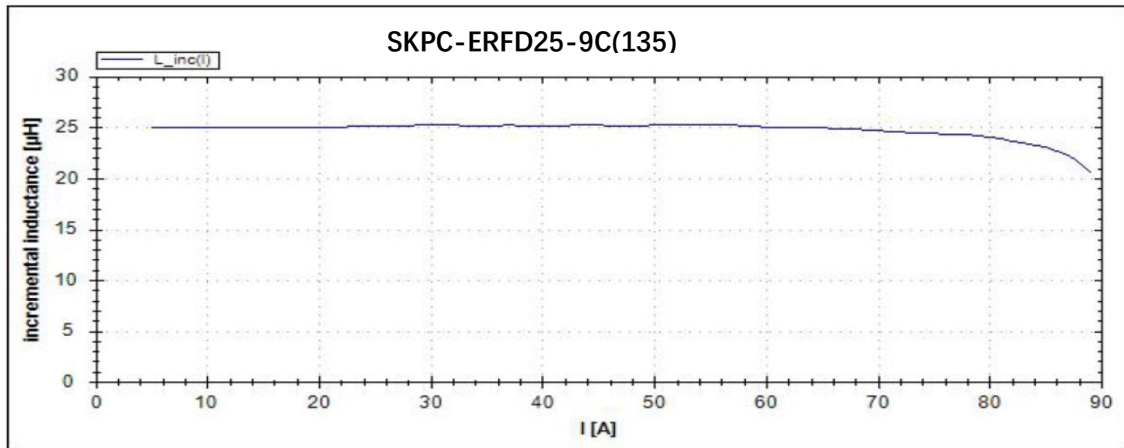

Inductor

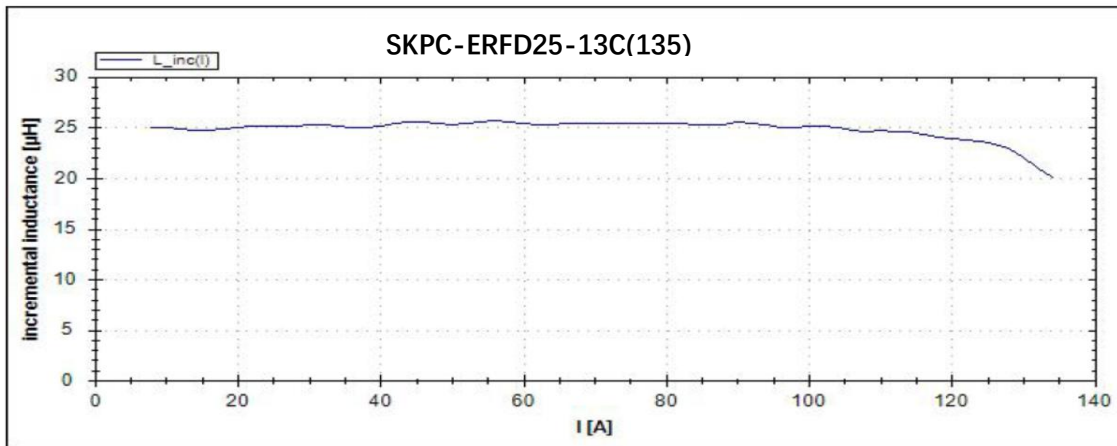
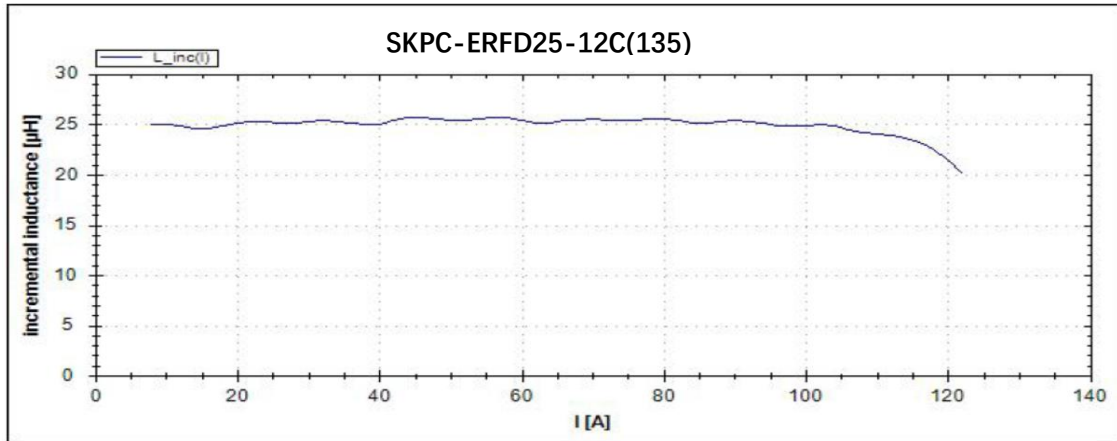

Note: This data is based on the DPG10 Power Choke Tester.