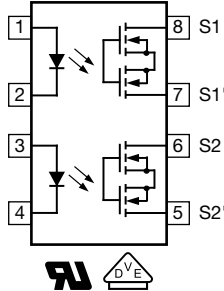
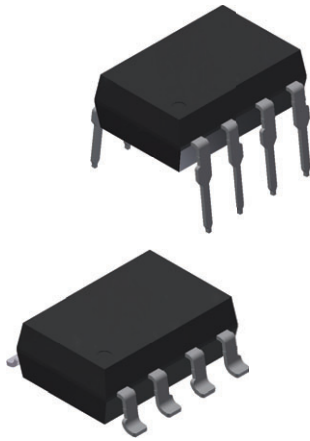


## Dual 1 Form A Solid-State Relay



### FEATURES

- Isolation test voltage 5300 V<sub>RMS</sub>
- Typical R<sub>ON</sub> 22 Ω
- Load voltage 400 V
- Load current 140 mA
- Clean bounce free switching
- Current limit protection
- Low power consumption
- Wide temperature range
- Material categorization: for definitions of compliance please see [www.vishay.com/doc?99912](http://www.vishay.com/doc?99912)



### DESCRIPTION

The VOR2142 is a 400 V dual channel normally open optically isolated solid-state relay (SPST - 1 form A). Based on hybrid architecture which allows fast switching times with a wide operating ambient temperature range. A high efficient GaAlAs IRED enables low forward current on the input side. On the output side high performance MOSFET switches provide a low R<sub>ON</sub> and can switch both DC and AC signals.

### APPLICATIONS

- General telecom switching
- Metering
- Security equipment
- Instrumentation
- Industrial controls
- Battery management systems
- Automatic test equipment

### AGENCY APPROVALS

- UL1577, file no. E52744
- DIN EN 60747-5-5 (VDE 0884-5)

ORDERING INFORMATION	
<div style="display: flex; justify-content: space-around; align-items: center;"> <div style="border: 1px solid black; padding: 2px 5px;">V</div> <div style="border: 1px solid black; padding: 2px 5px;">O</div> <div style="border: 1px solid black; padding: 2px 5px;">R</div> <div style="border: 1px solid black; padding: 2px 5px;">2</div> <div style="border: 1px solid black; padding: 2px 5px;">1</div> <div style="border: 1px solid black; padding: 2px 5px;">4</div> <div style="border: 1px solid black; padding: 2px 5px;">2</div> </div> <p style="text-align: center;">PART NUMBER</p>	<div style="display: flex; justify-content: space-around; align-items: center;"> <div style="border: 1px solid black; padding: 2px 5px;">#</div> <div style="border: 1px solid black; padding: 2px 5px;">8</div> <div style="border: 1px solid black; padding: 2px 5px;">#</div> </div> <p style="text-align: center;">PACKAGE CONFIGURATION</p> <div style="display: flex; justify-content: space-around; align-items: center;"> </div>
PACKAGE	UL, VDE
SMD-8, tape and reel	VOR2142B8T
SMD-8, tube	VOR2142B8
DIP-8, tube	VOR2142A8



<b>ABSOLUTE MAXIMUM RATINGS</b> ( $T_{amb} = 25\text{ }^{\circ}\text{C}$ , unless otherwise specified)				
PARAMETER	CONDITIONS	SYMBOL	VALUE	UNIT
<b>INPUT</b>				
IRED continuous forward current		$I_F$	50	mA
IRED reverse voltage		$V_R$	5	V
Input power dissipation		$P_{diss}$	80	mW
<b>OUTPUT</b>				
DC or peak AC load voltage		$V_L$	400	V
Continuous DC load current at 25 °C, one channel		$I_L$	140	mA
Continuous DC load current at 25 °C, two channels		$I_L$	100	mA
SSR output power dissipation		$P_{diss}$	550	mW
<b>SSR</b>				
Ambient temperature range		$T_{amb}$	-40 to +100	°C
Storage temperature range		$T_{stg}$	-40 to +150	°C
Soldering temperature	t = 10 s max.	$T_{sld}$	260	°C

**Note**

- Stresses in excess of the absolute maximum ratings can cause permanent damage to the device. Functional operation of the device is not implied at these or any other conditions in excess of those given in the operational sections of this document. Exposure to absolute maximum ratings for extended periods of the time can adversely affect reliability.

<b>ELECTRICAL CHARACTERISTICS</b> ( $T_{amb} = 25\text{ }^{\circ}\text{C}$ , unless otherwise specified)						
PARAMETER	TEST CONDITION	SYMBOL	MIN.	TYP.	MAX.	UNIT
<b>INPUT</b>						
IRED forward current, switch turn-on	$I_L = 100\text{ mA}$ , t = 10 ms	$I_{Fon}$	-	0.25	2	mA
IRED forward current, switch turn-off	$V_L = \pm 350\text{ V}$	$I_{Foff}$	0.05	0.15	-	mA
IRED forward voltage	$I_F = 10\text{ mA}$	$V_F$	-	1.36	1.5	V
IRED reverse current	$V_R = 5\text{ V}$	$I_R$	-	-	10	$\mu\text{A}$
<b>OUTPUT</b>						
On-resistance	$I_F = 5\text{ mA}$ , $I_L = 50\text{ mA}$	$R_{ON}$	-	22	27	$\Omega$
Off-resistance	$I_F = 0\text{ mA}$ , $V_L = \pm 100\text{ V}$	$R_{OFF}$	1	5000	-	G $\Omega$
Off-state leakage current	$I_F = 0\text{ mA}$ , $V_L = \pm 100\text{ V}$	$I_O$	-	< 1	100	nA
	$I_F = 0\text{ mA}$ , $V_L = \pm 400\text{ V}$	$I_O$	-	6	500	nA
Output capacitance	$I_F = 0\text{ mA}$ , $V_L = 1\text{ V}$ , 1 MHz	$C_O$	-	39	-	pF
	$I_F = 0\text{ mA}$ , $V_L = 50\text{ V}$ , 1 MHz	$C_O$	-	6	-	pF
Current limit AC/DC	$I_F = 5\text{ mA}$ , t = 5 ms, $V_L = \pm 6\text{ V}$	$I_{limit}$	170	300	450	mA
<b>TRANSFER</b>						
Capacitance (input to output)	$V_{IO} = 1\text{ V}$	$C_{IO}$	-	1	-	pF

**Note**

- Minimum and maximum values are testing requirements. Typical values are characteristics of the device and are the result of engineering evaluations. Typical values are for information only and are not part of the testing requirements.

<b>SWITCHING CHARACTERISTICS</b> ( $T_{amb} = 25\text{ }^{\circ}\text{C}$ , unless otherwise specified)						
PARAMETER	TEST CONDITION	SYMBOL	MIN.	TYP.	MAX.	UNIT
Turn-on time	$I_F = 5\text{ mA}$ , $I_L = 50\text{ mA}$	$t_{on}$	-	0.13	0.5	ms
Turn-off time	$I_F = 5\text{ mA}$ , $I_L = 50\text{ mA}$	$t_{off}$	-	0.05	0.2	ms

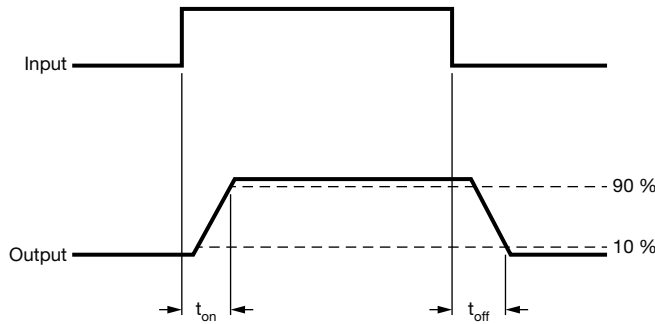
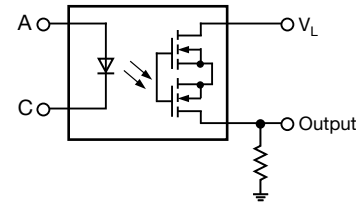


Fig. 1 - Timing Schematic



SAFETY AND INSULATION RATINGS				
PARAMETER	TEST CONDITION	SYMBOL	VALUE	UNIT
Climatic classification	According to IEC 68 part 1		40 / 100 / 21	
Pollution degree	According to DIN VDE 0109		2	
Comparative tracking index	Insulation group IIIa	CTI	175	
Maximum rated withstanding isolation voltage	According to UL1577, t = 1 min	$V_{ISO}$	5300	$V_{RMS}$
Maximum transient isolation voltage	According to DIN EN 60747-5-5	$V_{IOTM}$	8000	$V_{peak}$
Maximum repetitive peak isolation voltage	According to DIN EN 60747-5-5	$V_{IORM}$	890	$V_{peak}$
Isolation resistance	$V_{IO} = 500\text{ V}, T_{amb} = 25\text{ }^{\circ}\text{C}$	$R_{IO}$	$\geq 10^{12}$	$\Omega$
	$V_{IO} = 500\text{ V}, T_{amb} = 100\text{ }^{\circ}\text{C}$	$R_{IO}$	$\geq 10^{11}$	$\Omega$
Output safety power		$P_{SO}$	640	mW
Input safety current		$I_{SI}$	240	mA
Safety temperature		$T_S$	175	$^{\circ}\text{C}$
Creepage distance	DIP-8		$\geq 7$	mm
Clearance distance	DIP-8		$\geq 7$	mm
Creepage distance	SMD-8		$\geq 8$	mm
Clearance distance	SMD-8		$\geq 8$	mm
Insulation thickness		DTI	$\geq 0.4$	mm
Input to output test voltage, method B	$V_{IORM} \times 1.875 = V_{PR}$ , 100 % production test with $t_M = 1\text{ s}$ , partial discharge $< 5\text{ pC}$	$V_{PR}$	1669	$V_{peak}$
Input to output test voltage, method A	$V_{IORM} \times 1.6 = V_{PR}$ , 100 % sample test with $t_M = 10\text{ s}$ , partial discharge $< 5\text{ pC}$	$V_{PR}$	1424	$V_{peak}$

**Note**

- As per IEC 60747-5-5, § 7.4.3.8.2, this optocoupler is suitable for “safe electrical insulation” only within the safety ratings. Compliance with the safety ratings shall be ensured by means of protective circuits.

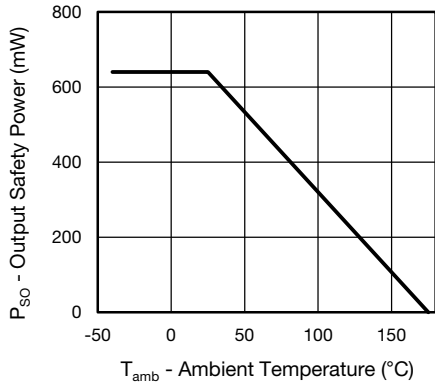


Fig. 2 - Safety Power Dissipation vs. Ambient Temperature

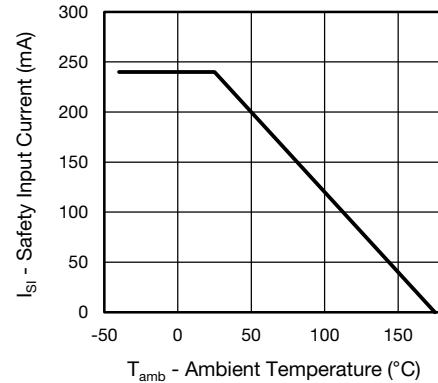


Fig. 3 - Safety Input Current vs. Ambient Temperature

**TYPICAL CHARACTERISTICS** ( $T_{amb} = 25\text{ }^{\circ}\text{C}$ , unless otherwise specified)

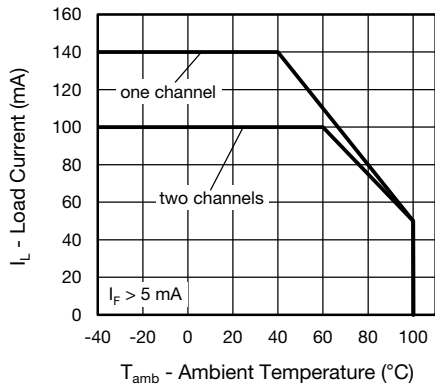


Fig. 4 - Maximum Load Current vs. Ambient Temperature

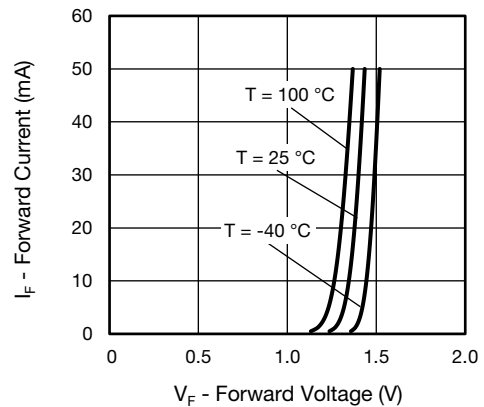


Fig. 6 - Forward Current vs. Forward Voltage

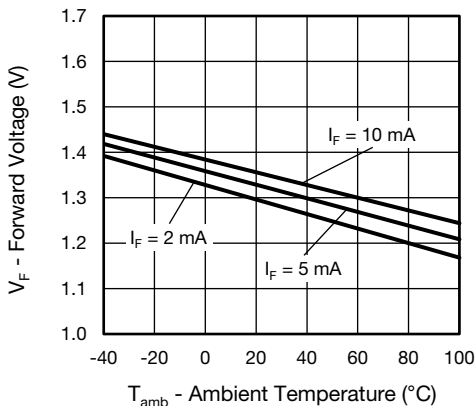


Fig. 5 - Forward Voltage vs. Ambient Temperature

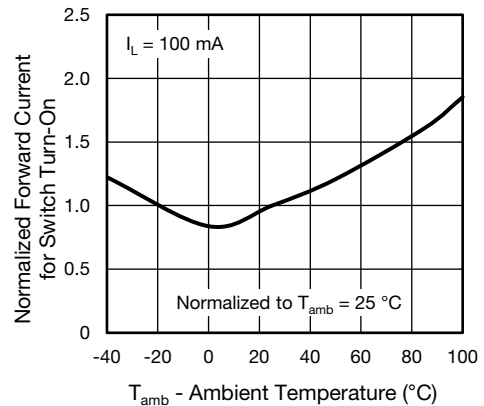


Fig. 7 - Normalized Forward Current for Switch Turn-On vs. Ambient Temperature

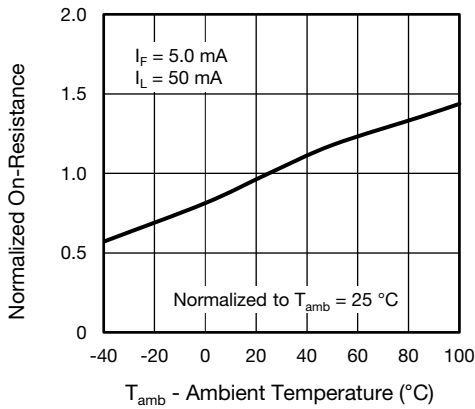


Fig. 8 - Normalized On-Resistance vs. Ambient Temperature

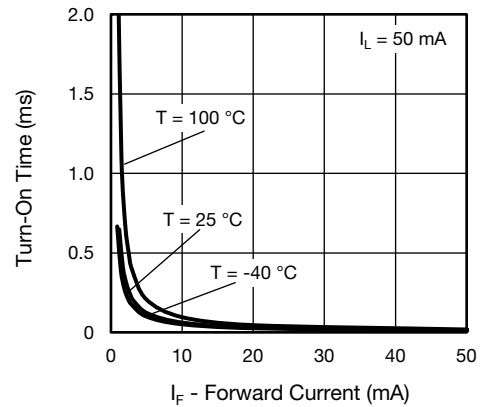


Fig. 11 - Turn-On Time vs. Forward Current

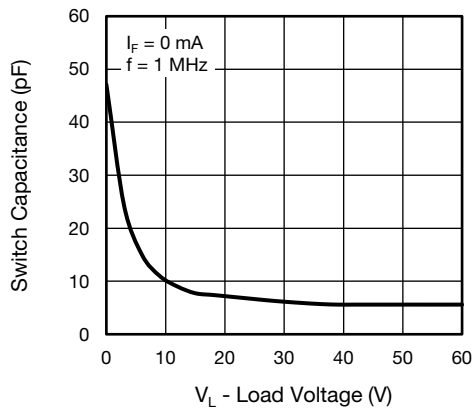


Fig. 9 - Output Capacitance vs. Load Voltage

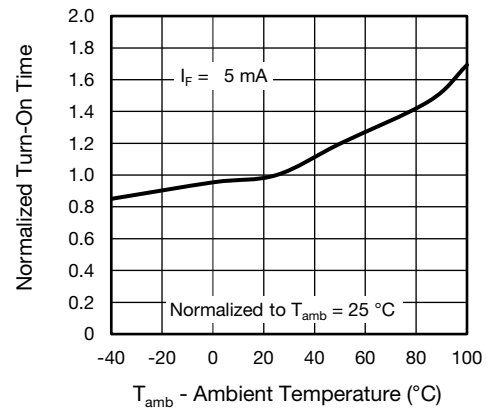


Fig. 12 - Normalized Turn-On Time vs. Ambient Temperature

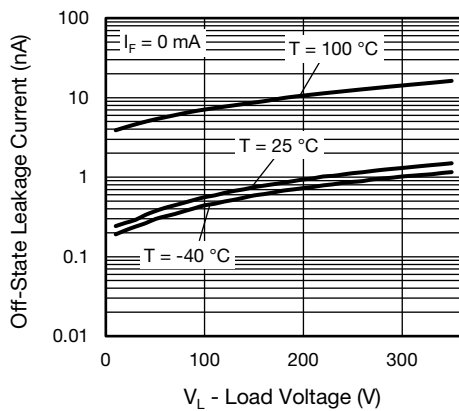


Fig. 10 - Off-State Leakage Current vs. Load Voltage

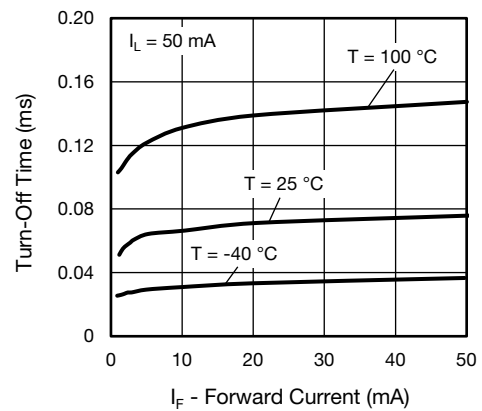


Fig. 13 - Turn-Off Time vs. Forward Current

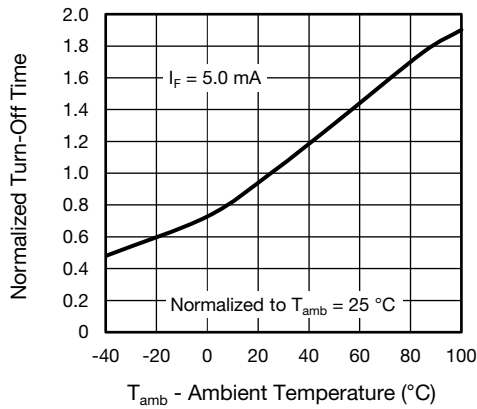
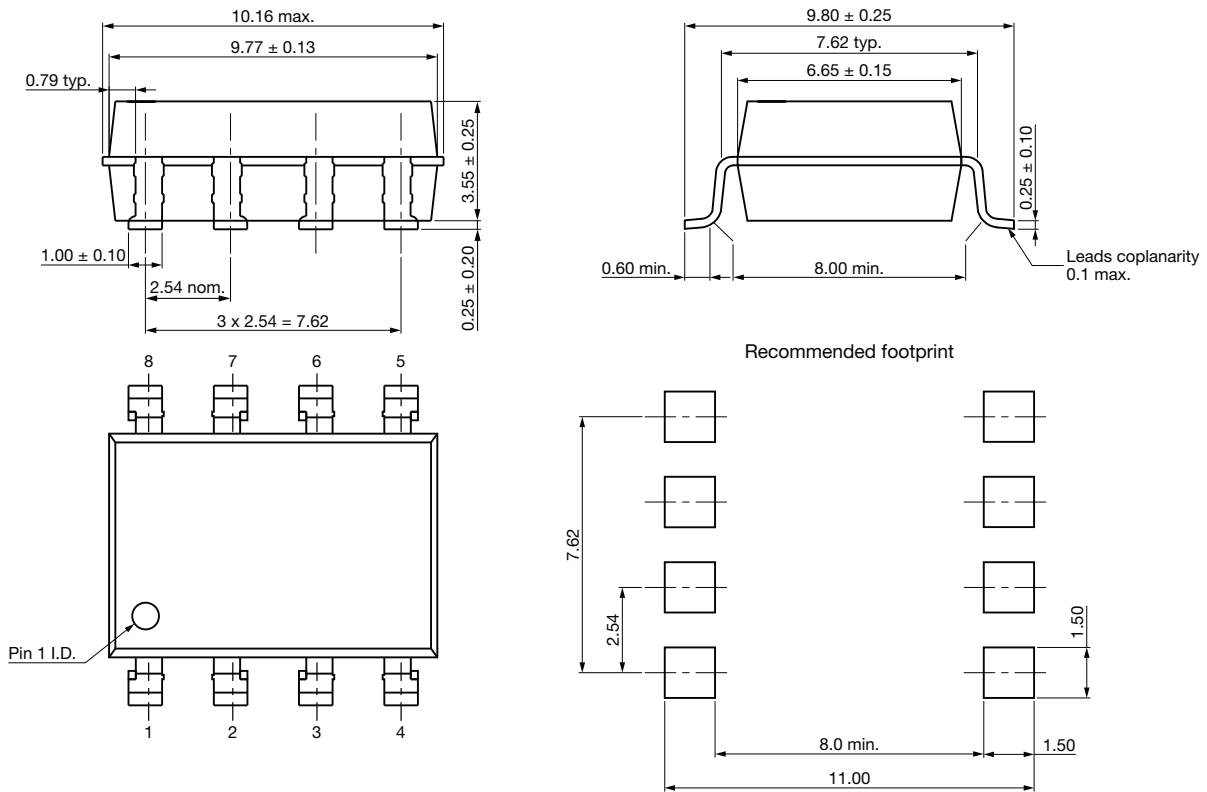


Fig. 14 - Normalized Turn-Off Time vs. Ambient Temperature

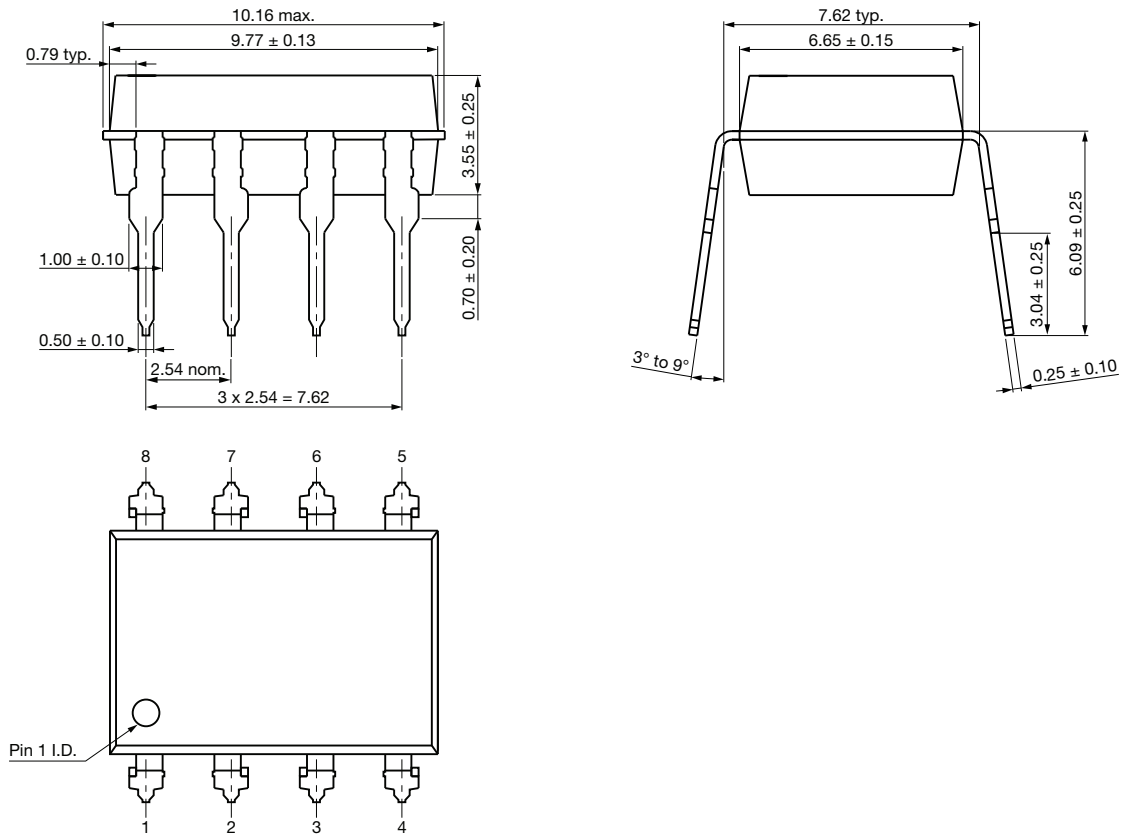
**PACKAGE DIMENSIONS** (in millimeters)

**SMD-8**





## DIP-8



## PACKAGE MARKING (example)

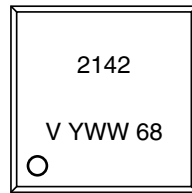


Fig. 15 - VOR2142

### Note

- Package configurations (T, A, B) are not part of the package marking.

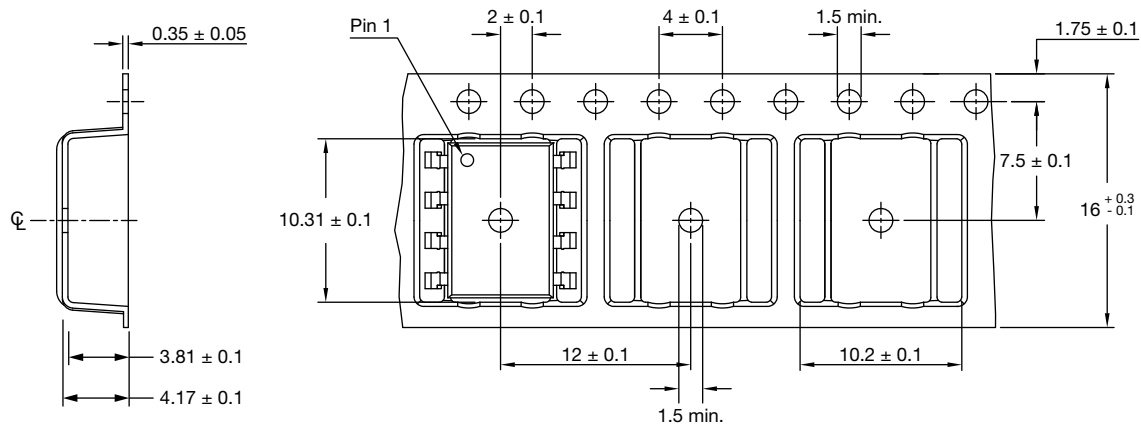
**PACKING INFORMATION** (in millimeters)


Fig. 16 - Tape and Reel Packing

TAPE AND REEL PACKING	
TYPE	UNITS/REEL
SMD-8	1000

TUBE PACKING			
TYPE	UNITS/TUBE	TUBES/BOX	UNITS/BOX
SMD-8	50	40	2000
DIP-8	50	40	2000

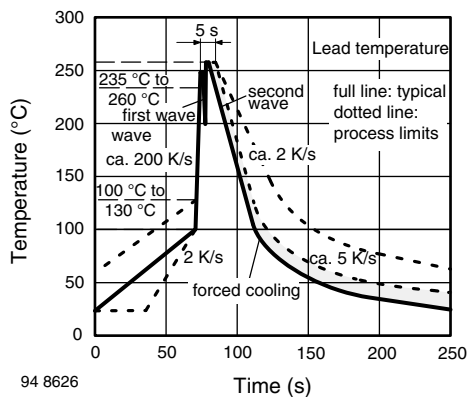
**SOLDER PROFILES**


Fig. 17 - Wave Soldering Double Wave Profile According to J-STD-020 for DIP Devices

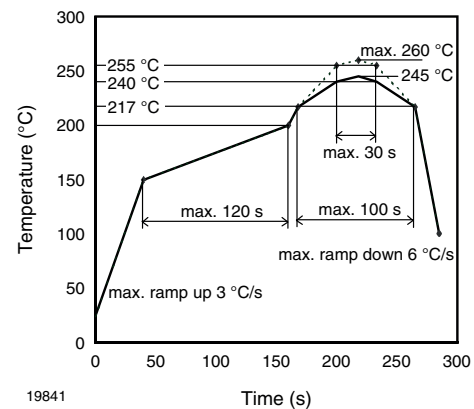


Fig. 18 - Lead (Pb)-free Reflow Solder Profile According to J-STD-020 for SMD Devices

**HANDLING AND STORAGE CONDITIONS**

ESD level: HBM class 2

Floor life: unlimited

 Conditions:  $T_{amb} < 30\text{ °C}$ , RH < 85 %

Moisture sensitivity level 1, according to J-STD-020





## Footprint and Schematic Information for VOR2142

The footprint and schematic symbols for the following parts can be accessed using the associated links. They are available in Eagle, Altium, KiCad, OrCAD / Allegro, Pulsonix, and PADS.

Note that the 3D models for these parts can be found on the Vishay product page.

PART NUMBER	FOOTPRINT / SCHEMATIC
VOR2142A8	<a href="http://www.snapeda.com/parts/VOR2142A8/Vishay/view-part">www.snapeda.com/parts/VOR2142A8/Vishay/view-part</a>
VOR2142B8	<a href="http://www.snapeda.com/parts/VOR2142B8/Vishay/view-part">www.snapeda.com/parts/VOR2142B8/Vishay/view-part</a>
VOR2142B8T	<a href="http://www.snapeda.com/parts/VOR2142B8T/Vishay/view-part">www.snapeda.com/parts/VOR2142B8T/Vishay/view-part</a>

For technical issues and product support, please contact [optocoupleranswers@vishay.com](mailto:optocoupleranswers@vishay.com).





## **Disclaimer**

ALL PRODUCT, PRODUCT SPECIFICATIONS AND DATA ARE SUBJECT TO CHANGE WITHOUT NOTICE TO IMPROVE RELIABILITY, FUNCTION OR DESIGN OR OTHERWISE.

Vishay Intertechnology, Inc., its affiliates, agents, and employees, and all persons acting on its or their behalf (collectively, "Vishay"), disclaim any and all liability for any errors, inaccuracies or incompleteness contained in any datasheet or in any other disclosure relating to any product.

Vishay makes no warranty, representation or guarantee regarding the suitability of the products for any particular purpose or the continuing production of any product. To the maximum extent permitted by applicable law, Vishay disclaims (i) any and all liability arising out of the application or use of any product, (ii) any and all liability, including without limitation special, consequential or incidental damages, and (iii) any and all implied warranties, including warranties of fitness for particular purpose, non-infringement and merchantability.

Statements regarding the suitability of products for certain types of applications are based on Vishay's knowledge of typical requirements that are often placed on Vishay products in generic applications. Such statements are not binding statements about the suitability of products for a particular application. It is the customer's responsibility to validate that a particular product with the properties described in the product specification is suitable for use in a particular application. Parameters provided in datasheets and / or specifications may vary in different applications and performance may vary over time. All operating parameters, including typical parameters, must be validated for each customer application by the customer's technical experts. Product specifications do not expand or otherwise modify Vishay's terms and conditions of purchase, including but not limited to the warranty expressed therein.

Except as expressly indicated in writing, Vishay products are not designed for use in medical, life-saving, or life-sustaining applications or for any other application in which the failure of the Vishay product could result in personal injury or death. Customers using or selling Vishay products not expressly indicated for use in such applications do so at their own risk. Please contact authorized Vishay personnel to obtain written terms and conditions regarding products designed for such applications.

No license, express or implied, by estoppel or otherwise, to any intellectual property rights is granted by this document or by any conduct of Vishay. Product names and markings noted herein may be trademarks of their respective owners.