8-bit AVR Microcontroller with 4/8K Bytes In-System Programmable Flash

SUMMARY DATASHEET**Features**

- High Performance, Low Power Atmel® AVR® 8-bit Microcontroller
- Advanced RISC Architecture
 - 120 Powerful Instructions – Most Single Clock Cycle Execution
 - 32 x 8 General Purpose Working Registers
 - Fully Static Operation
 - Up to 16 MIPS Throughput at 16 MHz
- Non-volatile Program and Data Memories
 - 4/8K Bytes of In-System Programmable Flash Program Memory
 - Endurance: 10,000 Write/Erase Cycles
 - 256/512 Bytes of In-System Programmable EEPROM
 - Endurance: 100,000 Write/Erase Cycles
 - 256/512 Bytes Internal SRAM
 - Data Retention: 20 Years at 85°C / 100 Years at 25°C
 - Programming Lock for Self-Programming Flash & EEPROM Data Security
- Peripheral Features
 - One 8-bit and Two 16-bit Timer/Counters with Two PWM Channels, Each
 - Programmable Ultra Low Power Watchdog Timer
 - 10-bit Analog to Digital Converter
 - 12 External and 5 Internal, Single-ended Input Channels
 - 46 Differential ADC Channel Pairs with Programmable Gain (1x / 20x / 100x)
 - Two On-chip Analog Comparators
 - Two Full Duplex USARTs with Start Frame Detection
 - Master/Slave SPI Serial Interface
 - Slave I²C Serial Interface
- Special Microcontroller Features
 - Low Power Idle, ADC Noise Reduction, Standby and Power-down Modes
 - Enhanced Power-on Reset Circuit
 - Programmable Brown-out Detection Circuit with Supply Voltage Sampling
 - External and Internal Interrupt Sources
 - Pin Change Interrupt on 12 Pins
 - Calibrated 8MHz Oscillator with Temperature Calibration Option
 - Calibrated 32kHz Ultra Low Power Oscillator
 - High-Current Drive Capability on 2 I/O Pins
- I/O and Packages
 - 14-pin SOIC, 20-pad MLF/QFN and 20-pad VQFN
 - 12 Programmable I/O Lines
- Speed Grade
 - 0 – 2 MHz @ 1.7 – 1.8V
 - 0 – 4 MHz @ 1.8 – 5.5V
 - 0 – 10 MHz @ 2.7 – 5.5V
 - 0 – 16 MHz @ 4.5 – 5.5V
- Low Power Consumption
 - Active Mode: 0.2 mA at 1.8V and 1MHz
 - Idle Mode: 30 µA at 1.8V and 1MHz
 - Power-Down Mode (WDT Enabled): 1.3µA at 1.8V
 - Power-Down Mode (WDT Disabled): 150nA at 1.8V

1. Pin Configurations

Figure 1-1. Pinout in 14-pin SOIC.

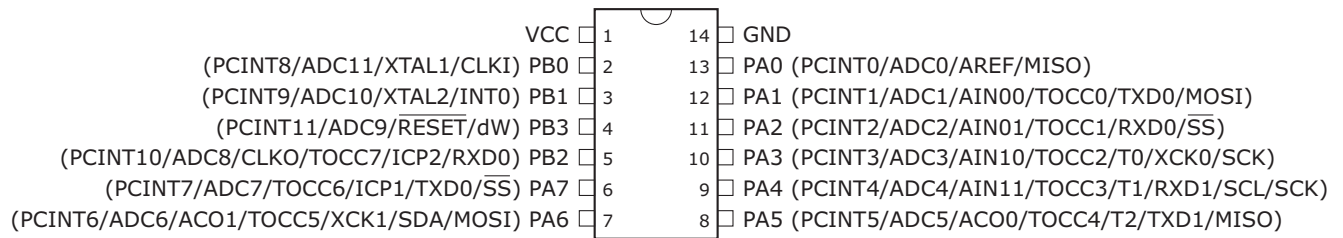
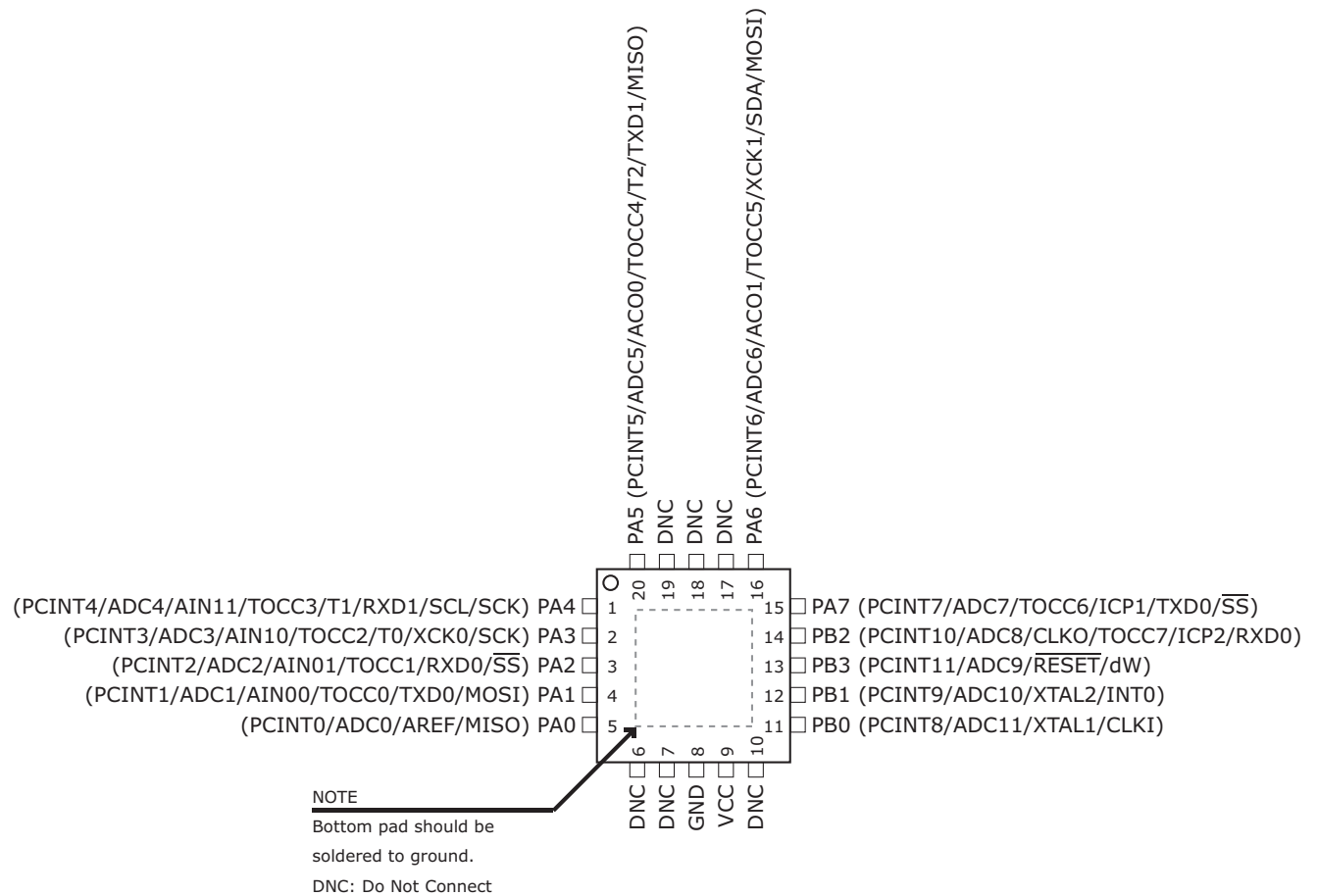

Figure 1-2. Pinout in 20-pad VQFN/WQFN.



1.1 Pin Description

1.1.1 VCC

Supply voltage.

1.1.2 GND

Ground.

1.1.3 RESET

Reset input. A low level on this pin for longer than the minimum pulse length will generate a reset, even if the clock is not running and provided the reset pin has not been disabled. Shorter pulses are not guaranteed to generate a reset.

The reset pin can also be used as a (weak) I/O pin.

1.1.4 Port A (PA7:PA0)

This is an 8-bit, bi-directional I/O port with internal pull-up resistors (selected for each bit). Output buffers have standard sink and source capability, except ports PA7 and PA5, which have high sink capability.

As inputs, port pins that are externally pulled low will source current provided that pull-up resistors are activated. Port pins are tri-stated when a reset condition becomes active, even if the clock is not running.

This port has alternative pin functions for pin change interrupts, the analog comparator, and ADC.

1.1.5 Port B (PB3:PB0)

This is a 4-bit, bi-directional I/O port with internal pull-up resistors (selected for each bit). Output buffers have standard sink and source capability.

As inputs, port pins that are externally pulled low will source current provided that pull-up resistors are activated. Port pins are tri-stated when a reset condition becomes active, even if the clock is not running.

This port has alternative pin functions for pin change interrupts, and ADC.

2. Overview

ATtiny441/841 is a low-power CMOS 8-bit microcontrollers based on the AVR enhanced RISC architecture. By executing powerful instructions in a single clock cycle, the ATtiny441/841 achieves throughputs approaching 1 MIPS per MHz allowing the system designer to optimize power consumption versus processing speed.

Figure 2-1. Block Diagram

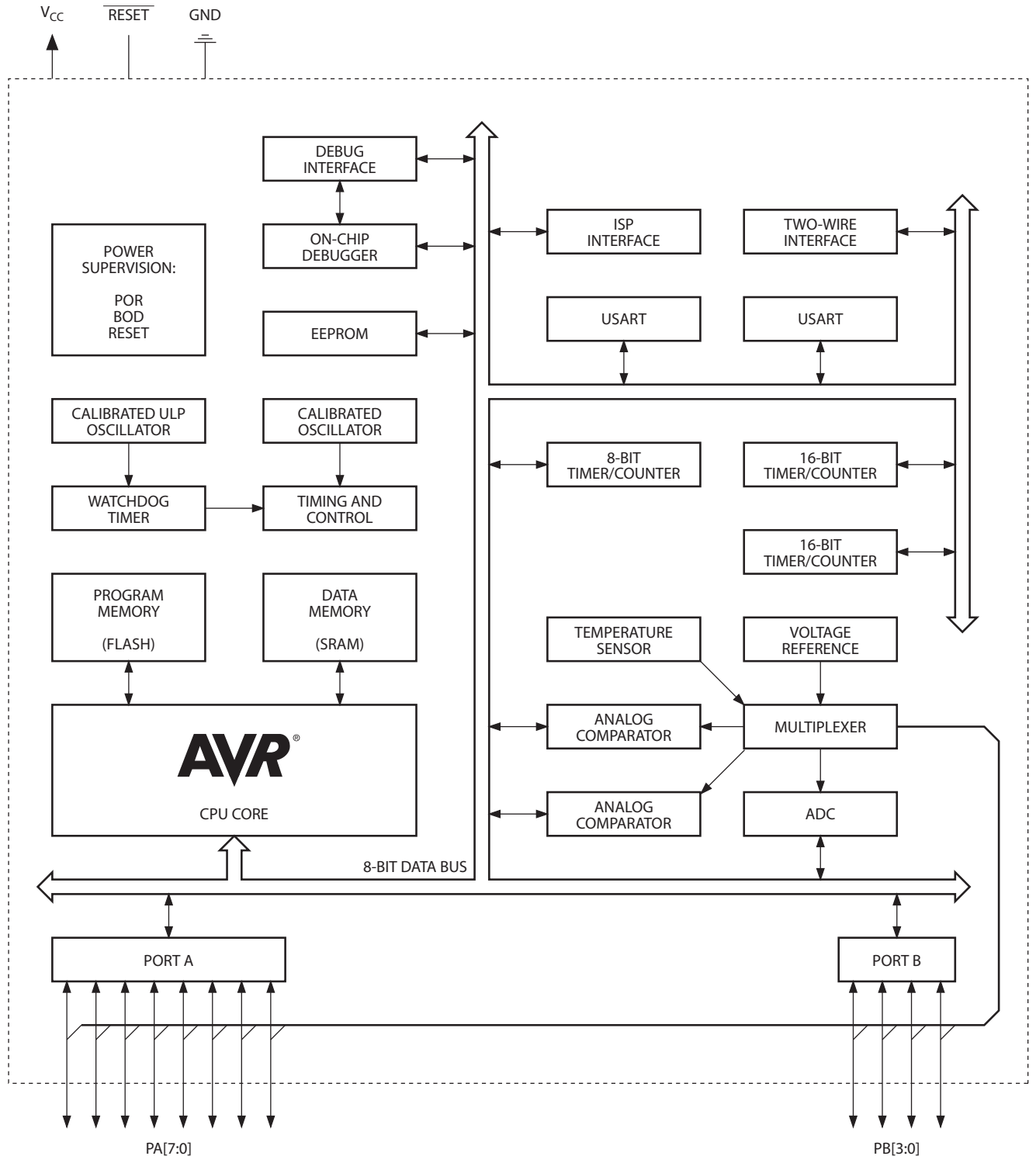

The AVR core combines a rich instruction set with 32 general purpose working registers. All 32 registers are directly connected to the Arithmetic Logic Unit (ALU), allowing two independent registers to be accessed in a single instruction, executed in one clock cycle. The resulting architecture is compact and code efficient while achieving throughputs up to ten times faster than conventional CISC microcontrollers.

ATtiny441/841 provides the following features:

- 4K/8K bytes of in-system programmable Flash
- 256/512 bytes of SRAM data memory
- 256/512 bytes of EEPROM data memory
- 12 general purpose I/O lines
- 32 general purpose working registers
- One 8-bit timer/counter with two PWM channels
- Two 16-bit timer/counters with two PWM channels
- Internal and external interrupts
- One 10-bit ADC with 5 internal and 12 external channels
- One ultra-low power, programmable watchdog timer with internal oscillator
- Two programmable USARTs with start frame detection
- Slave Two-Wire Interface (TWI)
- Master/slave Serial Peripheral Interface (SPI)
- Calibrated 8MHz oscillator
- Calibrated 32kHz, ultra low power oscillator
- Four software selectable power saving modes.

The device includes the following modes for saving power:

- Idle mode: stops the CPU while allowing the timer/counter, ADC, analog comparator, SPI, TWI, and interrupt system to continue functioning
- ADC Noise Reduction mode: minimizes switching noise during ADC conversions by stopping the CPU and all I/O modules except the ADC
- Power-down mode: registers keep their contents and all chip functions are disabled until the next interrupt or hardware reset
- Standby mode: the oscillator is running while the rest of the device is sleeping, allowing very fast start-up combined with low power consumption

The device is manufactured using Atmel's high density non-volatile memory technology. The Flash program memory can be re-programmed in-system through a serial interface, by a conventional non-volatile memory programmer or by an on-chip boot code, running on the AVR core.

The ATtiny441/841 AVR is supported by a full suite of program and system development tools including: C compilers, macro assemblers, program debugger/simulators and evaluation kits.

3. General Information

3.1 Resources

A comprehensive set of drivers, application notes, data sheets and descriptions on development tools are available for download at <http://www.atmel.com/avr>.

3.2 Code Examples

This documentation contains simple code examples that briefly show how to use various parts of the device. These code examples assume that the part specific header file is included before compilation. Be aware that not all C compiler vendors include bit definitions in the header files and interrupt handling in C is compiler dependent. Please confirm with the C compiler documentation for more details.

3.3 Data Retention

Reliability Qualification results show that the projected data retention failure rate is much less than 1 PPM over 20 years at 85°C or 100 years at 25°C.

3.4 Disclaimer

Typical values contained in this datasheet are based on simulations and characterization of other AVR microcontrollers manufactured on the same process technology.

4. Register Summary

Address	Name	Bit 7	Bit 6	Bit 5	Bit 4	Bit 3	Bit 2	Bit 1	Bit 0	Page(s)
(0xFF)	Reserved	-	-	-	-	-	-	-	-	
(0xFE)	Reserved	-	-	-	-	-	-	-	-	
(0xFD)	Reserved	-	-	-	-	-	-	-	-	
(0xFC)	Reserved	-	-	-	-	-	-	-	-	
(0xFB)	Reserved	-	-	-	-	-	-	-	-	
(0xFA)	Reserved	-	-	-	-	-	-	-	-	
(0xF9)	Reserved	-	-	-	-	-	-	-	-	
(0xF8)	Reserved	-	-	-	-	-	-	-	-	
(0xF7)	Reserved	-	-	-	-	-	-	-	-	
(0xF6)	Reserved	-	-	-	-	-	-	-	-	
(0xF5)	Reserved	-	-	-	-	-	-	-	-	
(0xF4)	Reserved	-	-	-	-	-	-	-	-	
(0xF3)	Reserved	-	-	-	-	-	-	-	-	
(0xF2)	Reserved	-	-	-	-	-	-	-	-	
(0xF1)	Reserved	-	-	-	-	-	-	-	-	
(0xF0)	Reserved	-	-	-	-	-	-	-	-	
(0xEF)	Reserved	-	-	-	-	-	-	-	-	
(0xEE)	Reserved	-	-	-	-	-	-	-	-	
(0xED)	Reserved	-	-	-	-	-	-	-	-	
(0xEC)	Reserved	-	-	-	-	-	-	-	-	
(0xEB)	Reserved	-	-	-	-	-	-	-	-	
(0xEA)	Reserved	-	-	-	-	-	-	-	-	
(0xE9)	Reserved	-	-	-	-	-	-	-	-	
(0xE8)	Reserved	-	-	-	-	-	-	-	-	
(0xE7)	Reserved	-	-	-	-	-	-	-	-	
(0xE6)	Reserved	-	-	-	-	-	-	-	-	
(0xE5)	Reserved	-	-	-	-	-	-	-	-	
(0xE4)	Reserved	-	-	-	-	-	-	-	-	
(0xE3)	Reserved	-	-	-	-	-	-	-	-	
(0xE2)	Reserved	-	-	-	-	-	-	-	-	
(0xE1)	Reserved	-	-	-	-	-	-	-	-	
(0xE0)	Reserved	-	-	-	-	-	-	-	-	
(0xDF)	Reserved	-	-	-	-	-	-	-	-	
(0xDE)	Reserved	-	-	-	-	-	-	-	-	
(0xDD)	Reserved	-	-	-	-	-	-	-	-	
(0xDC)	Reserved	-	-	-	-	-	-	-	-	
(0xDB)	Reserved	-	-	-	-	-	-	-	-	
(0xDA)	Reserved	-	-	-	-	-	-	-	-	
(0xD9)	Reserved	-	-	-	-	-	-	-	-	
(0xD8)	Reserved	-	-	-	-	-	-	-	-	
(0xD7)	Reserved	-	-	-	-	-	-	-	-	
(0xD6)	Reserved	-	-	-	-	-	-	-	-	
(0xD5)	Reserved	-	-	-	-	-	-	-	-	
(0xD4)	Reserved	-	-	-	-	-	-	-	-	
(0xD3)	Reserved	-	-	-	-	-	-	-	-	
(0xD2)	Reserved	-	-	-	-	-	-	-	-	
(0xD1)	Reserved	-	-	-	-	-	-	-	-	
(0xD0)	Reserved	-	-	-	-	-	-	-	-	
(0xCF)	Reserved	-	-	-	-	-	-	-	-	
(0xCE)	Reserved	-	-	-	-	-	-	-	-	
(0xCD)	Reserved	-	-	-	-	-	-	-	-	
(0xCC)	Reserved	-	-	-	-	-	-	-	-	
(0xCB)	Reserved	-	-	-	-	-	-	-	-	
(0xCA)	TCCR2A	COM2A1	COM2A0	COM2B1	COM2B0	-	-	WGM21	WGM20	Page 111
(0xC9)	TCCR2B	ICNC2	ICES2	-	WGM23	WGM22	CS22	CS21	CS20	Page 114
(0xC8)	TCCR2C	FOC2A	FOC2B	-	-	-	-	-	-	Page 115
(0xC7)	TCNT2H	Timer/Counter2 – Counter Register High Byte								Page 116
(0xC6)	TCNT2L	Timer/Counter2 – Counter Register Low Byte								Page 116
(0xC5)	OCR2AH	Timer/Counter2 – Output Compare Register A High Byte								Page 117
(0xC4)	OCR2AL	Timer/Counter2 – Output Compare Register A Low Byte								Page 117
(0xC3)	OCR2BH	Timer/Counter2 – Output Compare Register B High Byte								Page 117
(0xC2)	OCR2BL	Timer/Counter2 – Output Compare Register B Low Byte								Page 117
(0xC1)	ICR2H	Timer/Counter1 – Input Capture Register High Byte								Page 118
(0xC0)	ICR2L	Timer/Counter1 – Input Capture Register Low Byte								Page 118
(0xBF)	Reserved	-	-	-	-	-	-	-	-	

Address	Name	Bit 7	Bit 6	Bit 5	Bit 4	Bit 3	Bit 2	Bit 1	Bit 0	Page(s)	
(0xBE)	Reserved	-	-	-	-	-	-	-	-		
(0xBD)	Reserved	-	-	-	-	-	-	-	-		
(0xBC)	Reserved	-	-	-	-	-	-	-	-		
(0xBB)	Reserved	-	-	-	-	-	-	-	-		
(0xBA)	Reserved	-	-	-	-	-	-	-	-		
(0xB9)	Reserved	-	-	-	-	-	-	-	-		
(0xB8)	Reserved	-	-	-	-	-	-	-	-		
(0xB7)	Reserved	-	-	-	-	-	-	-	-		
(0xB6)	Reserved	-	-	-	-	-	-	-	-		
(0xB5)	Reserved	-	-	-	-	-	-	-	-		
(0xB4)	Reserved	-	-	-	-	-	-	-	-		
(0xB3)	Reserved	-	-	-	-	-	-	-	-		
(0xB2)	SPCR	SPIE	SPE	DORD	MSTR	CPOL	CPHA	SPR1	SPR0	Page 157	
(0xB1)	SPSR	SPIF	WCOL	-	-	-	-	-	SPI2X	Page 158	
(0xB0)	SPDR	SPI Data Register									Page 159
(0xAF)	Reserved	-	-	-	-	-	-	-	-		
(0xAE)	Reserved	-	-	-	-	-	-	-	-		
(0xAD)	Reserved	-	-	-	-	-	-	-	-		
(0xAC)	Reserved	-	-	-	-	-	-	-	-		
(0xAB)	Reserved	-	-	-	-	-	-	-	-		
(0xAA)	Reserved	-	-	-	-	-	-	-	-		
(0xA9)	Reserved	-	-	-	-	-	-	-	-		
(0xA8)	Reserved	-	-	-	-	-	-	-	-		
(0xA7)	Reserved	-	-	-	-	-	-	-	-		
(0xA6)	Reserved	-	-	-	-	-	-	-	-		
(0xA5)	TWSCRA	TWSHE	-	TWDIE	TWASIE	TWEN	TWSIE	TWPME	TWSME	Page 205	
(0xA4)	TWSCR	-	-	-	-	TWHNM	TWAA	TWCMD1	TWCMD0	Page 205	
(0xA3)	TWSSRA	TWDIF	TWASIF	TWCH	TWRA	TWC	TWBE	TWDIR	TWAS	Page 207	
(0xA2)	TWSA	TWI Slave Address Register									Page 208
(0xA1)	TWSAM	TWI Slave Address Mask Register							TWAE		Page 208
(0xA0)	TWSD	TWI Slave Data Register									Page 209
(0x9F)	Reserved	-	-	-	-	-	-	-	-		
(0x9E)	Reserved	-	-	-	-	-	-	-	-		
(0x9D)	Reserved	-	-	-	-	-	-	-	-		
(0x9C)	Reserved	-	-	-	-	-	-	-	-		
(0x9B)	Reserved	-	-	-	-	-	-	-	-		
(0x9A)	Reserved	-	-	-	-	-	-	-	-		
(0x99)	Reserved	-	-	-	-	-	-	-	-		
(0x98)	Reserved	-	-	-	-	-	-	-	-		
(0x97)	Reserved	-	-	-	-	-	-	-	-		
(0x96)	UCSR1A	RXC1	TXC1	UDRE1	FE1	DOR1	UPE1	U2X1	MPCM1	Page 181, 193	
(0x95)	UCSR1B	RXCIE1	TXCIE1	UDRIE1	RXEN1	TXEN1	UCSZ12	RXB81	TXB81	Page 182, 194	
(0x94)	UCSR1C	UMSEL11	UMSEL10	UPM11	UPM10	USBS1	UCSZ11	UCSZ10	UCPOL1	Page 183, 195	
(0x93)	UCSR1D	RXSIE1	RXS1	SFDE1	-	-	-	-	-	Page 185	
(0x92)	UBRR1H	USART1 Baud Register High Byte									Page 186, 196
(0x91)	UBRR1L	USART1 Baud Rate Register Low Byte									Page 186, 196
(0x90)	UDR1	USART1 Data Register									Pages 180, 192
(0x8F)	Reserved	-	-	-	-	-	-	-	-		
(0x8E)	Reserved	-	-	-	-	-	-	-	-		
(0x8D)	Reserved	-	-	-	-	-	-	-	-		
(0x8C)	Reserved	-	-	-	-	-	-	-	-		
(0x8B)	Reserved	-	-	-	-	-	-	-	-		
(0x8A)	Reserved	-	-	-	-	-	-	-	-		
(0x89)	Reserved	-	-	-	-	-	-	-	-		
(0x88)	Reserved	-	-	-	-	-	-	-	-		
(0x87)	Reserved	-	-	-	-	-	-	-	-		
(0x86)	UCSR0A	RXC0	TXC0	UDRE0	FE0	DOR0	UPE0	U2X0	MPCM0	Page 181, 193	
(0x85)	UCSR0B	RXCIE0	TXCIE0	UDRIE0	RXEN0	TXEN0	UCSZ02	RXB80	TXB80	Page 182, 194	
(0x84)	UCSR0C	UMSEL01	UMSEL00	UPM01	UPM00	USBS0	UCSZ01	UCSZ00	UCPOL0	Page 183, 195	
(0x83)	UCSR0D	RXSIE0	RXS0	SFDE0	-	-	-	-	-	Page 185	
(0x82)	UBRR0H	USART0 Baud Register High Byte									Page 186, 196
(0x81)	UBRR0L	USART0 Baud Rate Register Low Byte									Page 186, 196
(0x80)	UDR0	USART0 Data Register									Pages 180, 192
(0x7F)	Reserved	-	-	-	-	-	-	-	-		
(0x7E)	Reserved	-	-	-	-	-	-	-	-		
(0x7D)	Reserved	-	-	-	-	-	-	-	-		
(0x7C)	Reserved	-	-	-	-	-	-	-	-		
(0x7B)	Reserved	-	-	-	-	-	-	-	-		

Address	Name	Bit 7	Bit 6	Bit 5	Bit 4	Bit 3	Bit 2	Bit 1	Bit 0	Page(s)	
(0x7A)	Reserved	–	–	–	–	–	–	–	–		
(0x79)	Reserved	–	–	–	–	–	–	–	–		
(0x78)	Reserved	–	–	–	–	–	–	–	–		
(0x77)	OSCCAL1	–	–	–	–	–	–	CAL11	CAL10	Page 34	
(0x76)	OSCTCAL0B	Oscillator Temperature Compensation Register B									Page 34
(0x75)	OSCTCAL0A	Oscillator Temperature Compensation Register A									Page 33
(0x74)	OSCCAL0	CAL07	CAL06	CAL05	CAL04	CAL03	CAL02	CAL01	CAL00	Page 33	
(0x73)	CLKPR	–	–	–	–	CLKPS3	CLKPS2	CLKPS1	CLKPS0	Page 32	
(0x72)	CLKCR	OSCRDY	CSTR	CKOUTC	SUT	CKSEL3	CKSEL2	CKSEL1	CKSEL0	Page 31	
(0x71)	CCP	CPU Change Protection Register									Page 13
(0x70)	PRR	PRTWI	PRUSART1	PRUSART0	PRSPI	PRTIM2	PRTIM1	PRTIM0	PRADC	Page 38	
(0x6F)	Reserved	–	–	–	–	–	–	–	–		
(0x6E)	Reserved	–	–	–	–	–	–	–	–		
(0x6D)	Reserved	–	–	–	–	–	–	–	–		
(0x6C)	Reserved	–	–	–	–	–	–	–	–		
(0x6B)	Reserved	–	–	–	–	–	–	–	–		
(0x6A)	PHDE	–	–	–	–	–	–	PHDEA1	PHDEA0	Page 71	
(0x69)	Reserved	–	–	–	–	–	–	–	–		
(0x68)	TOCPMSA1	TOCC7S1	TOCC7S0	TOCC6S1	TOCC6S0	TOCC5S1	TOCC5S0	TOCC4S1	TOCC4S0	Page 115	
(0x67)	TOCPMSA0	TOCC3S1	TOCC3S0	TOCC2S1	TOCC2S0	TOCC1S1	TOCC1S0	TOCC0S1	TOCC0S0	Page 115	
(0x66)	TOCPMCOE	TOCC7OE	TOCC6OE	TOCC5OE	TOCC4OE	TOCC3OE	TOCC2OE	TOCC1OE	TOCC0OE	Page 116	
(0x65)	REMAP	–	–	–	–	–	–	SPIMAP	U0MAP	Pages 159, 186	
(0x64)	PORTCR	–	–	–	–	–	–	BBMB	BBMA	Page 71	
(0x63)	PUEA	PUEA7	PUEA6	PUEA5	PUEA4	PUEA3	PUEA2	PUEA1	PUEA0	Page 73	
(0x62)	PUEB	–	–	–	–	PUEB3	PUEB2	PUEB1	PUEB0	Page 71	
(0x61)	DIDR1	–	–	–	–	ADC9D	ADC8D	ADC10D	ADC11D	Page 150	
(0x60)	DIDR0	ADC7D	ADC6D	ADC5D	ADC4D	ADC3D	ADC2D	ADC1D	ADC0D	Pages 127, 131, 149	
0x3F (0x5F)	SREG	I	T	H	S	V	N	Z	C	Page 14	
0x3E (0x5E)	SPH	–	–	–	–	–	–	SP9	SP8	Page 13	
0x3D (0x5D)	SPL	SP7	SP6	SP5	SP4	SP3	SP2	SP1	SP0	Page 13	
0x3C (0x5C)	OCR0B	Timer/Counter0 – Output Compare Register B									Page 89
0x3B (0x5B)	GIMSK	–	INT0	PCIE1	PCIE0	–	–	–	–	Page 52	
0x3A (0x5A)	GIFR	–	INTF0	PCIF1	PCIF0	–	–	–	–	Page 53	
0x39 (0x59)	TIMSK0	–	–	–	–	–	OCIE0B	OCIE0A	TOIE0	Page 90	
0x38 (0x58)	TIFR0	–	–	–	–	–	OCF0B	OCF0A	TOV0	Page 90	
0x37 (0x57)	SPMCSR	–	–	RSIG	CTPB	RFLB	PGWRT	PGERS	SPMEN	Page 217	
0x36 (0x56)	OCR0A	Timer/Counter0 – Output Compare Register A									Page 89
0x35 (0x55)	MCUCR	–	–	SE	SM1	SM0	–	ISC01	ISC00	Page 38, 52	
0x34 (0x54)	MCUSR	–	–	–	–	WDRF	BORF	EXTRF	PORF	Page 46	
0x33 (0x53)	TCCR0B	FOC0A	FOC0B	–	–	WGM02	CS02	CS01	CS00	Page 88	
0x32 (0x52)	TCNT0	Timer/Counter0 – Counter Register									Page 89
0x31 (0x51)	Reserved	–	–	–	–	–	–	–	–		
0x30 (0x50)	TCCR0A	COM0A1	COM0A0	COM0B1	COM0B0	–	–	WGM01	WGM00	Page 85	
0x2F (0x4F)	TCCR1A	COM1A1	COM1A0	COM1B1	COM1B0	–	–	WGM11	WGM10	Page 111	
0x2E (0x4E)	TCCR1B	ICNC1	ICES1	–	WGM13	WGM12	CS12	CS11	CS10	Page 114	
0x2D (0x4D)	TCNT1H	Timer/Counter1 – Counter Register High Byte									Page 116
0x2C (0x4C)	TCNT1L	Timer/Counter1 – Counter Register Low Byte									Page 116
0x2B (0x4B)	OCR1AH	Timer/Counter1 – Output Compare Register A High Byte									Page 117
0x2A (0x4A)	OCR1AL	Timer/Counter1 – Output Compare Register A Low Byte									Page 117
0x29 (0x49)	OCR1BH	Timer/Counter1 – Output Compare Register B High Byte									Page 117
0x28 (0x48)	OCR1BL	Timer/Counter1 – Output Compare Register B Low Byte									Page 117
0x27 (0x47)	DWDR	debugWire Data Register									Page 211
0x26 (0x46)	Reserved	–	–	–	–	–	–	–	–		
0x25 (0x45)	ICR1H	Timer/Counter1 – Input Capture Register High Byte									Page 118
0x24 (0x44)	ICR1L	Timer/Counter1 – Input Capture Register Low Byte									Page 118
0x23 (0x43)	GTCCR	TSM	–	–	–	–	–	–	PSR	Page 122	
0x22 (0x42)	TCCR1C	FOC1A	FOC1B	–	–	–	–	–	–	Page 115	
0x21 (0x41)	WDTCR	WDIF	WDIE	WDP3	–	WDE	WDP2	WDP1	WDP0	Page 47	
0x20 (0x40)	PCMSK1	–	–	–	–	PCINT11	PCINT10	PCINT9	PCINT8	Page 54	
0x1F (0x3F)	EEARH	EEPROM Address Register High Byte									Page 21
0x1E (0x3E)	EEARL	EEPROM Address Register Low Byte									Page 22
0x1D (0x3D)	EEDR	EEPROM Data Register									Page 22
0x1C (0x3C)	EEDR	–	–	EEDR1	EEDR0	EEDR7	EEDR6	EEDR5	EEDR4	Page 22	
0x1B (0x3B)	PORTA	PORTA7	PORTA6	PORTA5	PORTA4	PORTA3	PORTA2	PORTA1	PORTA0	Page 73	
0x1A (0x3A)	DDRA	DDA7	DDA6	DDA5	DDA4	DDA3	DDA2	DDA1	DDA0	Page 73	
0x19 (0x39)	PINA	PINA7	PINA6	PINA5	PINA4	PINA3	PINA2	PINA1	PINA0	Page 73	
0x18 (0x38)	PORTB	–	–	–	–	PORTB3	PORTB2	PORTB1	PORTB0	Page 72	
0x17 (0x37)	DDRB	–	–	–	–	DDB3	DDB2	DDB1	DDB0	Page 72	

Address	Name	Bit 7	Bit 6	Bit 5	Bit 4	Bit 3	Bit 2	Bit 1	Bit 0	Page(s)
0x16 (0x36)	PINB	–	–	–	–	PINB3	PINB2	PINB1	PINB0	Page 72
0x15 (0x35)	GPIOR2	General Purpose I/O Register 2								Page 24
0x14 (0x34)	GPIOR1	General Purpose I/O Register 1								Page 24
0x13 (0x33)	GPIOR0	General Purpose I/O register 0								Page 24
0x12 (0x32)	PCMSK0	PCINT7	PCINT6	PCINT5	PCINT4	PCINT3	PCINT2	PCINT1	PCINT0	Page 54
0x11 (0x31)	TIMSK2	–	–	ICIE2	–	–	OCIE2B	OCIE2A	TOIE2	Page 118
0x10 (0x30)	TIFR2	–	–	ICF2	–	–	OCF2B	OCF2A	TOV2	Page 119
0x0F (0x2F)	TIMSK1	–	–	ICIE1	–	–	OCIE1B	OCIE1A	TOIE1	Page 118
0x0E (0x2E)	TIFR1	–	–	ICF1	–	–	OCF1B	OCF1A	TOV1	Page 119
0x0D (0x2D)	ACSR1B	HSEL1	HLEV1	–	ACOE1	–	ACME1	–	–	Page 130
0x0C (0x2C)	ACSR1A	ACD1	ACBG1	ACO1	ACI1	ACIE1	ACIC1	ACIS11	ACIS10	Page 129
0x0B (0x2B)	ACSR0B	HSEL0	HLEV0	–	ACOE0	ACNMUX01	ACNMUX00	ACPMUX01	ACPMUX00	Page 126
0x0A (0x2A)	ACSR0A	ACD0	ACPMUX02	ACO0	ACI0	ACIE0	ACIC0	ACIS01	ACIS00	Page 125
0x09 (0x29)	ADMUXA	–	–	MUX5	MUX4	MUX3	MUX2	MUX1	MUX0	Page 143
0x08 (0x28)	ADMUXB	REFS2	REFS1	REFS0	–	–	–	GSEL1	GSEL0	Page 146
0x07 (0x27)	ADCH	ADC – Conversion Result High Byte								Page 147
0x06 (0x26)	ADCL	ADC – Conversion Result Low Byte								Page 147
0x05 (0x25)	ADCSRA	ADEN	ADSC	ADATE	ADIF	ADIE	ADPS2	ADPS1	ADPS0	Page 148
0x04 (0x24)	ADCSRB	–	–	–	–	ADLAR	ADTS2	ADT1	ADTS0	Page 149
0x03 (0x23)	Reserved	–	–	–	–	–	–	–	–	
0x02 (0x22)	Reserved	–	–	–	–	–	–	–	–	
0x01 (0x21)	Reserved	–	–	–	–	–	–	–	–	
0x00 (0x20)	Reserved	–	–	–	–	–	–	–	–	

- Note:
1. For compatibility with future devices, reserved bits should be written to zero if accessed. Reserved I/O memory addresses should never be written.
 2. I/O Registers within the address range 0x00 - 0x1F are directly bit-accessible using the SBI and CBI instructions. In these registers, the value of single bits can be checked by using the SBIS and SBIC instructions.
 3. Some of the Status Flags are cleared by writing a logical one to them. Note that, unlike most other AVRs, the CBI and SBI instructions will only operation the specified bit, and can therefore be used on registers containing such Status Flags. The CBI and SBI instructions work with registers 0x00 to 0x1F only.

5. Instruction Set Summary

Mnemonics	Operands	Description	Operation	Flags	#Clocks
ARITHMETIC AND LOGIC INSTRUCTIONS					
ADD	Rd, Rr	Add two Registers	$Rd \leftarrow Rd + Rr$	Z,C,N,V,H	1
ADC	Rd, Rr	Add with Carry two Registers	$Rd \leftarrow Rd + Rr + C$	Z,C,N,V,H	1
ADIW	RdI, K	Add Immediate to Word	$Rdh:Rdl \leftarrow Rdh:Rdl + K$	Z,C,N,V,S	2
SUB	Rd, Rr	Subtract two Registers	$Rd \leftarrow Rd - Rr$	Z,C,N,V,H	1
SUBI	Rd, K	Subtract Constant from Register	$Rd \leftarrow Rd - K$	Z,C,N,V,H	1
SBC	Rd, Rr	Subtract with Carry two Registers	$Rd \leftarrow Rd - Rr - C$	Z,C,N,V,H	1
SBCI	Rd, K	Subtract with Carry Constant from Reg.	$Rd \leftarrow Rd - K - C$	Z,C,N,V,H	1
SBIW	RdI, K	Subtract Immediate from Word	$Rdh:Rdl \leftarrow Rdh:Rdl - K$	Z,C,N,V,S	2
AND	Rd, Rr	Logical AND Registers	$Rd \leftarrow Rd \bullet Rr$	Z,N,V	1
ANDI	Rd, K	Logical AND Register and Constant	$Rd \leftarrow Rd \bullet K$	Z,N,V	1
OR	Rd, Rr	Logical OR Registers	$Rd \leftarrow Rd \vee Rr$	Z,N,V	1
ORI	Rd, K	Logical OR Register and Constant	$Rd \leftarrow Rd \vee K$	Z,N,V	1
EOR	Rd, Rr	Exclusive OR Registers	$Rd \leftarrow Rd \oplus Rr$	Z,N,V	1
COM	Rd	One's Complement	$Rd \leftarrow 0xFF - Rd$	Z,C,N,V	1
NEG	Rd	Two's Complement	$Rd \leftarrow 0x00 - Rd$	Z,C,N,V,H	1
SBR	Rd, K	Set Bit(s) in Register	$Rd \leftarrow Rd \vee K$	Z,N,V	1
CBR	Rd, K	Clear Bit(s) in Register	$Rd \leftarrow Rd \bullet (0xFF - K)$	Z,N,V	1
INC	Rd	Increment	$Rd \leftarrow Rd + 1$	Z,N,V	1
DEC	Rd	Decrement	$Rd \leftarrow Rd - 1$	Z,N,V	1
TST	Rd	Test for Zero or Minus	$Rd \leftarrow Rd \bullet Rd$	Z,N,V	1
CLR	Rd	Clear Register	$Rd \leftarrow Rd \oplus Rd$	Z,N,V	1
SER	Rd	Set Register	$Rd \leftarrow 0xFF$	None	1
BRANCH INSTRUCTIONS					
RJMP	k	Relative Jump	$PC \leftarrow PC + k + 1$	None	2
IJMP		Indirect Jump to (Z)	$PC \leftarrow Z$	None	2
RCALL	k	Relative Subroutine Call	$PC \leftarrow PC + k + 1$	None	3
ICALL		Indirect Call to (Z)	$PC \leftarrow Z$	None	3
RET		Subroutine Return	$PC \leftarrow STACK$	None	4
RETI		Interrupt Return	$PC \leftarrow STACK$	I	4
CPSE	Rd, Rr	Compare, Skip if Equal	if (Rd = Rr) $PC \leftarrow PC + 2$ or 3	None	1/2/3
CP	Rd, Rr	Compare	$Rd - Rr$	Z, N, V, C, H	1
CPC	Rd, Rr	Compare with Carry	$Rd - Rr - C$	Z, N, V, C, H	1
CPI	Rd, K	Compare Register with Immediate	$Rd - K$	Z, N, V, C, H	1
SBRC	Rr, b	Skip if Bit in Register Cleared	if (Rr(b)=0) $PC \leftarrow PC + 2$ or 3	None	1/2/3
SBRS	Rr, b	Skip if Bit in Register is Set	if (Rr(b)=1) $PC \leftarrow PC + 2$ or 3	None	1/2/3
SBIC	P, b	Skip if Bit in I/O Register Cleared	if (P(b)=0) $PC \leftarrow PC + 2$ or 3	None	1/2/3
SBIS	P, b	Skip if Bit in I/O Register is Set	if (P(b)=1) $PC \leftarrow PC + 2$ or 3	None	1/2/3
BRBS	s, k	Branch if Status Flag Set	if (SREG(s) = 1) then $PC \leftarrow PC + k + 1$	None	1/2
BRBC	s, k	Branch if Status Flag Cleared	if (SREG(s) = 0) then $PC \leftarrow PC + k + 1$	None	1/2
BREQ	k	Branch if Equal	if (Z = 1) then $PC \leftarrow PC + k + 1$	None	1/2
BRNE	k	Branch if Not Equal	if (Z = 0) then $PC \leftarrow PC + k + 1$	None	1/2
BRCS	k	Branch if Carry Set	if (C = 1) then $PC \leftarrow PC + k + 1$	None	1/2
BRCC	k	Branch if Carry Cleared	if (C = 0) then $PC \leftarrow PC + k + 1$	None	1/2
BRSH	k	Branch if Same or Higher	if (C = 0) then $PC \leftarrow PC + k + 1$	None	1/2
BRLO	k	Branch if Lower	if (C = 1) then $PC \leftarrow PC + k + 1$	None	1/2
BRMI	k	Branch if Minus	if (N = 1) then $PC \leftarrow PC + k + 1$	None	1/2
BRPL	k	Branch if Plus	if (N = 0) then $PC \leftarrow PC + k + 1$	None	1/2
BRGE	k	Branch if Greater or Equal, Signed	if (N \oplus V = 0) then $PC \leftarrow PC + k + 1$	None	1/2
BRLT	k	Branch if Less Than Zero, Signed	if (N \oplus V = 1) then $PC \leftarrow PC + k + 1$	None	1/2
BRHS	k	Branch if Half Carry Flag Set	if (H = 1) then $PC \leftarrow PC + k + 1$	None	1/2
BRHC	k	Branch if Half Carry Flag Cleared	if (H = 0) then $PC \leftarrow PC + k + 1$	None	1/2
BRTS	k	Branch if T Flag Set	if (T = 1) then $PC \leftarrow PC + k + 1$	None	1/2
BRTC	k	Branch if T Flag Cleared	if (T = 0) then $PC \leftarrow PC + k + 1$	None	1/2
BRVS	k	Branch if Overflow Flag is Set	if (V = 1) then $PC \leftarrow PC + k + 1$	None	1/2
BRVC	k	Branch if Overflow Flag is Cleared	if (V = 0) then $PC \leftarrow PC + k + 1$	None	1/2
BRIE	k	Branch if Interrupt Enabled	if (I = 1) then $PC \leftarrow PC + k + 1$	None	1/2
BRID	k	Branch if Interrupt Disabled	if (I = 0) then $PC \leftarrow PC + k + 1$	None	1/2
BIT AND BIT-TEST INSTRUCTIONS					
SBI	P, b	Set Bit in I/O Register	$I/O(P, b) \leftarrow 1$	None	2
CBI	P, b	Clear Bit in I/O Register	$I/O(P, b) \leftarrow 0$	None	2
LSL	Rd	Logical Shift Left	$Rd(n+1) \leftarrow Rd(n), Rd(0) \leftarrow 0$	Z,C,N,V	1
LSR	Rd	Logical Shift Right	$Rd(n) \leftarrow Rd(n+1), Rd(7) \leftarrow 0$	Z,C,N,V	1
ROL	Rd	Rotate Left Through Carry	$Rd(0) \leftarrow C, Rd(n+1) \leftarrow Rd(n), C \leftarrow Rd(7)$	Z,C,N,V	1
ROR	Rd	Rotate Right Through Carry	$Rd(7) \leftarrow C, Rd(n) \leftarrow Rd(n+1), C \leftarrow Rd(0)$	Z,C,N,V	1

Mnemonics	Operands	Description	Operation	Flags	#Clocks
ASR	Rd	Arithmetic Shift Right	$Rd(n) \leftarrow Rd(n+1), n=0..6$	Z,C,N,V	1
SWAP	Rd	Swap Nibbles	$Rd(3..0) \leftarrow Rd(7..4), Rd(7..4) \leftarrow Rd(3..0)$	None	1
BSET	s	Flag Set	$SREG(s) \leftarrow 1$	SREG(s)	1
BCLR	s	Flag Clear	$SREG(s) \leftarrow 0$	SREG(s)	1
BST	Rr, b	Bit Store from Register to T	$T \leftarrow Rr(b)$	T	1
BLD	Rd, b	Bit load from T to Register	$Rd(b) \leftarrow T$	None	1
SEC		Set Carry	$C \leftarrow 1$	C	1
CLC		Clear Carry	$C \leftarrow 0$	C	1
SEN		Set Negative Flag	$N \leftarrow 1$	N	1
CLN		Clear Negative Flag	$N \leftarrow 0$	N	1
SEZ		Set Zero Flag	$Z \leftarrow 1$	Z	1
CLZ		Clear Zero Flag	$Z \leftarrow 0$	Z	1
SEI		Global Interrupt Enable	$I \leftarrow 1$	I	1
CLI		Global Interrupt Disable	$I \leftarrow 0$	I	1
SES		Set Signed Test Flag	$S \leftarrow 1$	S	1
CLS		Clear Signed Test Flag	$S \leftarrow 0$	S	1
SEV		Set Twos Complement Overflow.	$V \leftarrow 1$	V	1
CLV		Clear Twos Complement Overflow	$V \leftarrow 0$	V	1
SET		Set T in SREG	$T \leftarrow 1$	T	1
CLT		Clear T in SREG	$T \leftarrow 0$	T	1
SEH		Set Half Carry Flag in SREG	$H \leftarrow 1$	H	1
CLH		Clear Half Carry Flag in SREG	$H \leftarrow 0$	H	1
DATA TRANSFER INSTRUCTIONS					
MOV	Rd, Rr	Move Between Registers	$Rd \leftarrow Rr$	None	1
MOVW	Rd, Rr	Copy Register Word	$Rd+1:Rd \leftarrow Rr+1:Rr$	None	1
LDI	Rd, K	Load Immediate	$Rd \leftarrow K$	None	1
LD	Rd, X	Load Indirect	$Rd \leftarrow (X)$	None	2
LD	Rd, X+	Load Indirect and Post-Inc.	$Rd \leftarrow (X), X \leftarrow X + 1$	None	2
LD	Rd, -X	Load Indirect and Pre-Dec.	$X \leftarrow X - 1, Rd \leftarrow (X)$	None	2
LD	Rd, Y	Load Indirect	$Rd \leftarrow (Y)$	None	2
LD	Rd, Y+	Load Indirect and Post-Inc.	$Rd \leftarrow (Y), Y \leftarrow Y + 1$	None	2
LD	Rd, -Y	Load Indirect and Pre-Dec.	$Y \leftarrow Y - 1, Rd \leftarrow (Y)$	None	2
LDD	Rd, Y+q	Load Indirect with Displacement	$Rd \leftarrow (Y + q)$	None	2
LD	Rd, Z	Load Indirect	$Rd \leftarrow (Z)$	None	2
LD	Rd, Z+	Load Indirect and Post-Inc.	$Rd \leftarrow (Z), Z \leftarrow Z + 1$	None	2
LD	Rd, -Z	Load Indirect and Pre-Dec.	$Z \leftarrow Z - 1, Rd \leftarrow (Z)$	None	2
LDD	Rd, Z+q	Load Indirect with Displacement	$Rd \leftarrow (Z + q)$	None	2
LDS	Rd, k	Load Direct from SRAM	$Rd \leftarrow (k)$	None	2
ST	X, Rr	Store Indirect	$(X) \leftarrow Rr$	None	2
ST	X+, Rr	Store Indirect and Post-Inc.	$(X) \leftarrow Rr, X \leftarrow X + 1$	None	2
ST	-X, Rr	Store Indirect and Pre-Dec.	$X \leftarrow X - 1, (X) \leftarrow Rr$	None	2
ST	Y, Rr	Store Indirect	$(Y) \leftarrow Rr$	None	2
ST	Y+, Rr	Store Indirect and Post-Inc.	$(Y) \leftarrow Rr, Y \leftarrow Y + 1$	None	2
ST	-Y, Rr	Store Indirect and Pre-Dec.	$Y \leftarrow Y - 1, (Y) \leftarrow Rr$	None	2
STD	Y+q, Rr	Store Indirect with Displacement	$(Y + q) \leftarrow Rr$	None	2
ST	Z, Rr	Store Indirect	$(Z) \leftarrow Rr$	None	2
ST	Z+, Rr	Store Indirect and Post-Inc.	$(Z) \leftarrow Rr, Z \leftarrow Z + 1$	None	2
ST	-Z, Rr	Store Indirect and Pre-Dec.	$Z \leftarrow Z - 1, (Z) \leftarrow Rr$	None	2
STD	Z+q, Rr	Store Indirect with Displacement	$(Z + q) \leftarrow Rr$	None	2
STS	k, Rr	Store Direct to SRAM	$(k) \leftarrow Rr$	None	2
LPM		Load Program Memory	$R0 \leftarrow (Z)$	None	3
LPM	Rd, Z	Load Program Memory	$Rd \leftarrow (Z)$	None	3
LPM	Rd, Z+	Load Program Memory and Post-Inc	$Rd \leftarrow (Z), Z \leftarrow Z + 1$	None	3
SPM		Store Program Memory	$(Z) \leftarrow R1:R0$	None	-
IN	Rd, P	In Port	$Rd \leftarrow P$	None	1
OUT	P, Rr	Out Port	$P \leftarrow Rr$	None	1
PUSH	Rr	Push Register on Stack	$STACK \leftarrow Rr$	None	2
POP	Rd	Pop Register from Stack	$Rd \leftarrow STACK$	None	2
MCU CONTROL INSTRUCTIONS					
NOP		No Operation		None	1
SLEEP		Sleep	(see specific descr. for Sleep function)	None	1
WDR		Watchdog Reset	(see specific descr. for WDR/timer)	None	1
BREAK		Break	For On-chip Debug Only	None	N/A

6. Ordering Information

6.1 ATtiny441

Speed	Supply Voltage	Temperature Range	Package ⁽¹⁾	Ordering Code
16 MHz	1.7 – 5.5V	Industrial (-40°C to +85°C) ⁽²⁾	14S1	ATtiny441-SSU
				ATtiny441-SSUR
			20M1	ATtiny441-MU
				ATtiny441-MUR
			20M2	ATtiny441-MMH
				ATtiny441-MMHR

- Notes:
1. All packages are Pb-free, halide-free and fully green and they comply with the European directive for Restriction of Hazardous Substances (RoHS).
 2. These devices can also be supplied in wafer form. Please contact your local Atmel sales office for detailed ordering information and minimum quantities.

Package Type	
14S1	14-lead, 0.150" Wide Body, Plastic Gull Wing Small Outline Package (SOIC)
20M1	20-pad, 4 x 4 x 0.8 mm Body, Quad Flat No-Lead / Micro Lead Frame Package (QFN/MLF)
20M2	20-pad, 3 x 3 x 0.85 mm Body, Very Thin Quad Flat No Lead Package (VQFN)

6.2 ATtiny841

Speed	Supply Voltage	Temperature Range	Package ⁽¹⁾	Ordering Code
16 MHz	1.7 – 5.5V	Industrial (-40°C to +85°C) ⁽²⁾	14S1	ATtiny841-SSU
				ATtiny841-SSUR
			20M1	ATtiny841-MU
				ATtiny841-MUR
			20M2	ATtiny841-MMH
				ATtiny841-MMHR

- Notes:
1. All packages are Pb-free, halide-free and fully green and they comply with the European directive for Restriction of Hazardous Substances (RoHS).
 2. These devices can also be supplied in wafer form. Please contact your local Atmel sales office for detailed ordering information and minimum quantities.

Package Type	
14S1	14-lead, 0.150" Wide Body, Plastic Gull Wing Small Outline Package (SOIC)
20M1	20-pad, 4 x 4 x 0.8 mm Body, Quad Flat No-Lead / Micro Lead Frame Package (QFN/MLF)
20M2	20-pad, 3 x 3 x 0.85 mm Body, Very Thin Quad Flat No Lead Package (VQFN)

7. Packaging Information

7.1 14S1

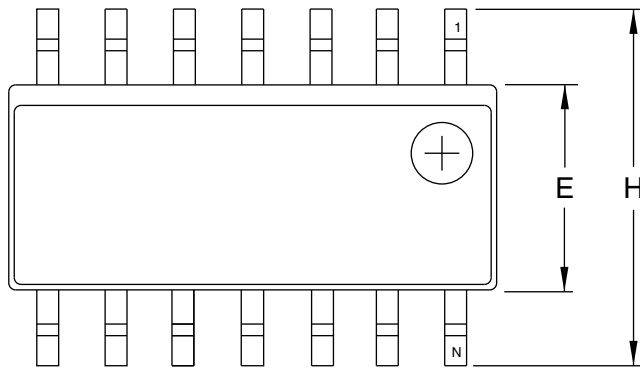

Top View

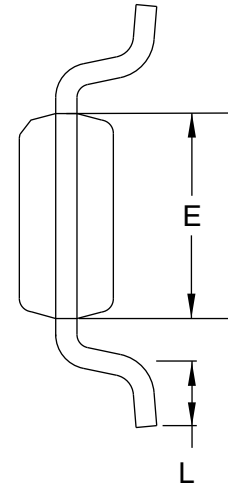

End View

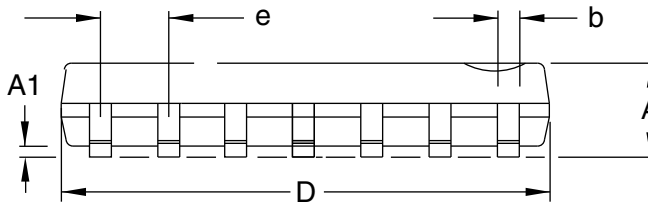

Side View

COMMON DIMENSIONS
(Unit of Measure = mm/inches)

SYMBOL	MIN	NOM	MAX	NOTE
A	1.35/0.0532	–	1.75/0.0688	
A1	0.1/0.0040	–	0.25/0.0098	
b	0.33/0.0130	–	0.5/0.02005	
D	8.55/0.3367	–	8.74/0.3444	2
E	3.8/0.1497	–	3.99/0.1574	3
H	5.8/0.2284	–	6.19/0.2440	
L	0.41/0.0160	–	1.27/0.0500	4
e	1.27/0.050 BSC			

- Notes:
1. This drawing is for general information only; refer to JEDEC Drawing MS-012, Variation AB for additional information.
 2. Dimension D does not include mold Flash, protrusions or gate burrs. Mold Flash, protrusion and gate burrs shall not exceed 0.15 mm (0.006") per side.
 3. Dimension E does not include inter-lead Flash or protrusion. Inter-lead flash and protrusions shall not exceed 0.25 mm (0.010") per side.
 4. L is the length of the terminal for soldering to a substrate.
 5. The lead width B, as measured 0.36 mm (0.014") or greater above the seating plane, shall not exceed a maximum value of 0.61 mm (0.024") per side.

2/5/02



2325 Orchard Parkway
San Jose, CA 95131

TITLE

14S1, 14-lead, 0.150" Wide Body, Plastic Gull Wing Small Outline Package (SOIC)

DRAWING NO.

14S1

REV.

A

7.2 20M1

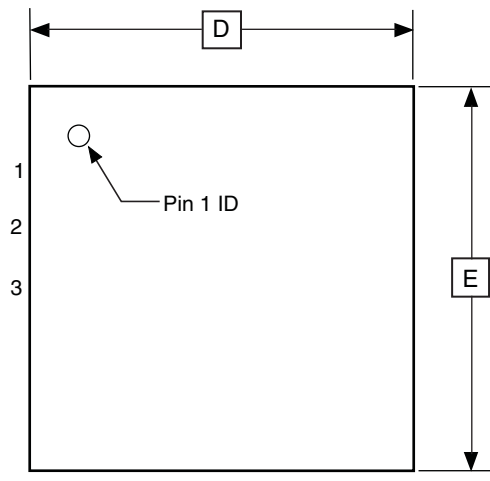

TOP VIEW

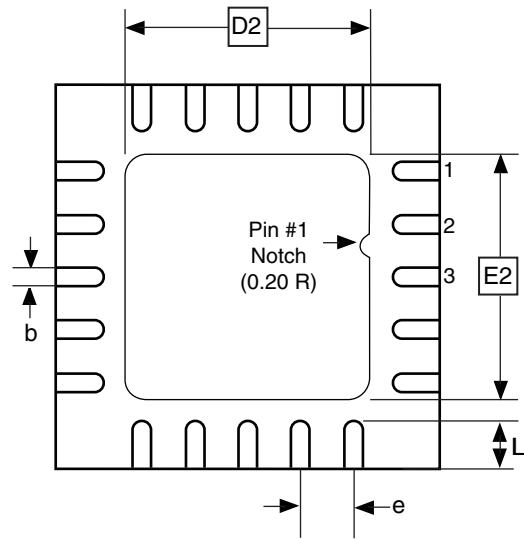

BOTTOM VIEW

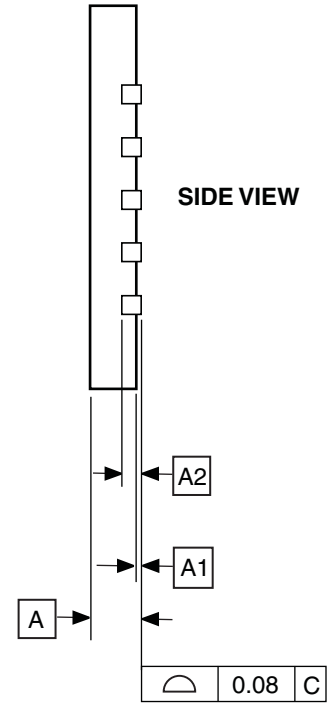

SIDE VIEW

COMMON DIMENSIONS
(Unit of Measure = mm)

SYMBOL	MIN	NOM	MAX	NOTE
A	0.70	0.75	0.80	
A1	-	0.01	0.05	
A2	0.20 REF			
b	0.18	0.23	0.30	
D	4.00 BSC			
D2	2.45	2.60	2.75	
E	4.00 BSC			
E2	2.45	2.60	2.75	
e	0.50 BSC			
L	0.35	0.40	0.55	

Note: Reference JEDEC Standard MO-220, Fig.1 (SAW Singulation) WGGD-5.

12/02/2014

 2325 Orchard Parkway San Jose, CA 95131	TITLE 20M1, 20-pad, 4 x 4 x 0.8 mm Body, Lead Pitch 0.50 mm, 2.6 mm Exposed Pad, Micro Lead Frame Package (MLF)	DRAWING NO. 20M1	REV. B

7.3 20M2

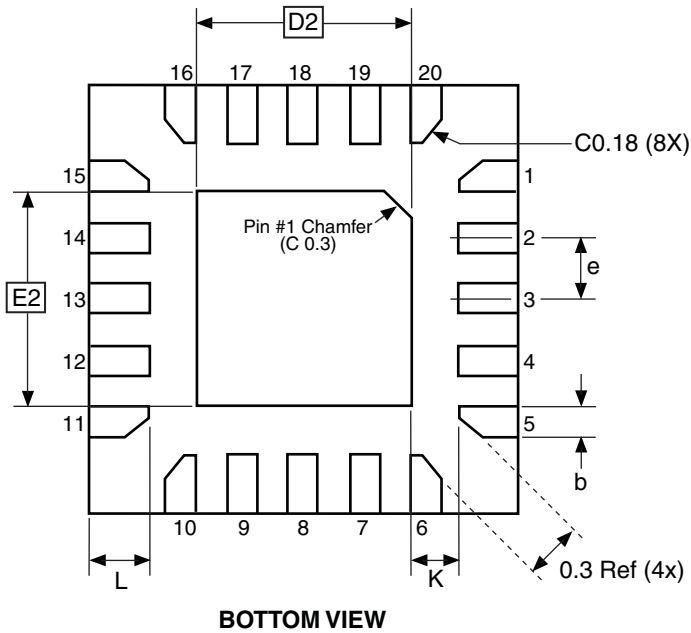
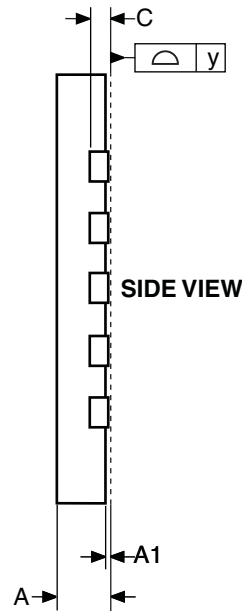
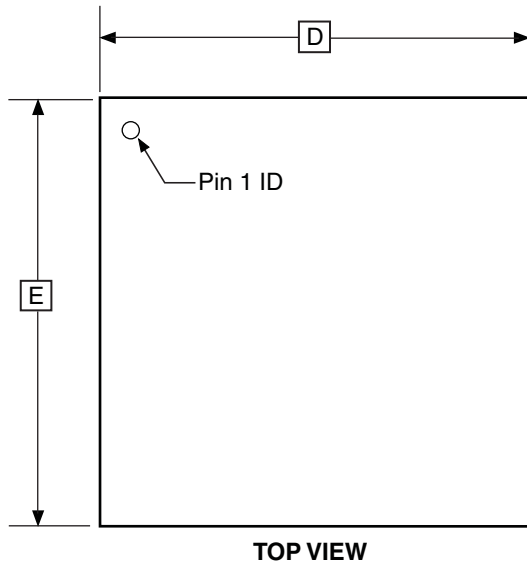

COMMON DIMENSIONS
(Unit of Measure = mm)

SYMBOL	MIN	NOM	MAX	NOTE
A	0.75	0.80	0.85	
A1	0.00	0.02	0.05	
b	0.17	0.22	0.27	
C	0.152			
D	2.90	3.00	3.10	
D2	1.40	1.55	1.70	
E	2.90	3.00	3.10	
E2	1.40	1.55	1.70	
e	-	0.45	-	
L	0.35	0.40	0.45	
K	0.20	-	-	
y	0.00	-	0.08	

10/24/08



Package Drawing Contact:
packagedrawings@atmel.com

TITLE
20M2, 20-pad, 3 x 3 x 0.85 mm Body, Lead Pitch 0.45 mm,
1.55 x 1.55 mm Exposed Pad, Thermally Enhanced
Plastic Very Thin Quad Flat No Lead Package (VQFN)

GPC
ZFC

DRAWING NO.
20M2

REV.
B

8. Errata

8.1 ATtiny441

8.1.1 Rev. D

No known erratas.

8.1.2 Rev. C

Not sampled

8.1.3 Rev. B

Not sampled.

8.1.4 Rev. A

Not sampled

8.2 ATtiny841

8.2.1 Rev. C

No known erratas.

8.2.2 Rev. B

Issue: **Non-volatile Memories Should Not Be Written at High Temperatures And Low Voltages**

Reliability issues have been detected when Flash, EEPROM or Fuse Bytes are programmed at voltages below 3V AND temperatures above 55°C.

Workaround: Do not write to Flash, EEPROM or Fuse bytes when supply voltage is below 3V AND device temperature is above 55°C.

8.2.3 Rev. A

Issue: **Non-volatile Memories Should Not Be Written at High Temperatures And Low Voltages**

Reliability issues have been detected when Flash, EEPROM or Fuse Bytes are programmed at voltages below 3V AND temperatures above 55°C.

Workaround: Do not write to Flash, EEPROM or Fuse bytes when supply voltage is below 3V AND device temperature is above 55°C.

9. Datasheet Revision History

Doc. Rev.	Date	Comments
8495A	09/2012	Initial revision
8495B	12/2012	Updated Figure 1-1 on page 2 , Figure 1-2 on page 2 , and REMAP register on pages 159 , 186 and 7 . Added ATtiny241.
8495C	03/2013	Updated " Ordering Information ": All -SU and SUR updated to -SSU and -SSUR.
8495D	07/2013	Removed references to ATtiny241 which will not be offered.
8495E	08/2013	Updated " Device Signature Imprint Table " on page 220 .
8495F	10/2013	Added Typical Characterization plots.
8495G	01/2014	System and Reset Characteristics: Updated min and max limits of Internal bandgap voltage (V _{BG}) in: Section 25.1.5 on page 240 Section 25.2.5 on page 249
8495H	05/2014	Updated WDT code example: RSTFLR register replaced with MCUSR.



Enabling Unlimited Possibilities®

Atmel Corporation

1600 Technology Drive
San Jose, CA 95110
USA

Tel: (+1) (408) 441-0311

Fax: (+1) (408) 487-2600

www.atmel.com

Atmel Asia Limited

Unit 01-5 & 16, 19F
BEA Tower, Millennium City 5
418 Kwun Tong Road
Kwun Tong, Kowloon
HONG KONG

Tel: (+852) 2245-6100

Fax: (+852) 2722-1369

Atmel Munich GmbH

Business Campus
Parkring 4
D-85748 Garching b. Munich
GERMANY

Tel: (+49) 89-31970-0

Fax: (+49) 89-3194621

Atmel Japan G.K.

16F Shin-Osaki Kangyo Bldg
1-6-4 Osaki, Shinagawa-ku
Tokyo 141-0032
JAPAN

Tel: (+81) (3) 6417-0300

Fax: (+81) (3) 6417-0370

© 2014 Atmel Corporation. All rights reserved. / Rev.: 8495HS-AVR-05/2014

Atmel®, Atmel logo and combinations thereof, Enabling Unlimited Possibilities®, AVR® and others are registered trademarks or trademarks of Atmel Corporation or its subsidiaries. Other terms and product names may be trademarks of others.

Disclaimer: The information in this document is provided in connection with Atmel products. No license, express or implied, by estoppel or otherwise, to any intellectual property right is granted by this document or in connection with the sale of Atmel products. EXCEPT AS SET FORTH IN THE ATMEL TERMS AND CONDITIONS OF SALES LOCATED ON THE ATMEL WEBSITE, ATMEL ASSUMES NO LIABILITY WHATSOEVER AND DISCLAIMS ANY EXPRESS, IMPLIED OR STATUTORY WARRANTY RELATING TO ITS PRODUCTS INCLUDING, BUT NOT LIMITED TO, THE IMPLIED WARRANTY OF MERCHANTABILITY, FITNESS FOR A PARTICULAR PURPOSE, OR NON-INFRINGEMENT. IN NO EVENT SHALL ATMEL BE LIABLE FOR ANY DIRECT, INDIRECT, CONSEQUENTIAL, PUNITIVE, SPECIAL OR INCIDENTAL DAMAGES (INCLUDING, WITHOUT LIMITATION, DAMAGES FOR LOSS AND PROFITS, BUSINESS INTERRUPTION, OR LOSS OF INFORMATION) ARISING OUT OF THE USE OR INABILITY TO USE THIS DOCUMENT, EVEN IF ATMEL HAS BEEN ADVISED OF THE POSSIBILITY OF SUCH DAMAGES. Atmel makes no representations or warranties with respect to the accuracy or completeness of the contents of this document and reserves the right to make changes to specifications and products descriptions at any time without notice. Atmel does not make any commitment to update the information contained herein. Unless specifically provided otherwise, Atmel products are not suitable for, and shall not be used in, automotive applications. Atmel products are not intended, authorized, or warranted for use as components in applications intended to support or sustain life.