

## RL78/L12

R01DS0157EJ0212

### RENESAS MCU

Rev.2.12

Dec 22, 2020

True low-power platform (62.5  $\mu$ A/MHz, and 0.64  $\mu$ A for operation with only RTC and LVD) for the LCD-based applications, with the on-chip LCD controller and driver, 8- to 32-Kbyte code flash memory, 1.6-V to 5.5-V operation, and 31 DMIPS at 24 MHz

## 1. OUTLINE

### 1.1 Features

#### Ultra-Low Power Technology

- 1.6 V to 5.5 V operation from a single supply
- Stop (RAM retained): 0.23  $\mu$ A, (LVD enabled): 0.31  $\mu$ A
- Halt (RTC + LVD): 0.64  $\mu$ A
- Supports snooze
- Operating: 62.5  $\mu$ A/MHz
- LCD operating current (Capacitor split method): 0.12  $\mu$ A
- LCD operating current (Internal voltage boost method): 0.63  $\mu$ A ( $V_{DD} = 3.0$  V)

#### 16-bit RL78 CPU Core

- Delivers 31 DMIPS at maximum operating frequency of 24 MHz
- Instruction Execution: 86% of instructions can be executed in 1 to 2 clock cycles
- CISC Architecture (Harvard) with 3-stage pipeline
- Multiply Signed & Unsigned: 16 x 16 to 32-bit result in 1 clock cycle
- MAC: 16 x 16 to 32-bit result in 2 clock cycles
- 16-bit barrel shifter for shift & rotate in 1 clock cycle
- 1-wire on-chip debug function

#### Code Flash Memory

- Density: 8 KB to 32 KB
- Block size: 1 KB
- On-chip single voltage flash memory with protection from block erase/writing
- Self-programming with flash shield window function

#### Data Flash Memory

- Data flash with background operation
- Data flash size: 2 KB size
- Erase cycles: 1 Million (typ.)
- Erase/programming voltage: 1.8 V to 5.5 V

#### RAM

- 1 KB and 1.5 KB size options
- Supports operands or instructions
- Back-up retention in all modes

#### High-speed On-chip Oscillator

- 24 MHz with  $\pm 1\%$  accuracy over voltage (1.8 V to 5.5 V) and temperature ( $-20^{\circ}\text{C}$  to  $85^{\circ}\text{C}$ )
- Pre-configured settings: 24 MHz, 16 MHz, 12 MHz, 8 MHz, 6 MHz, 4 MHz, 3 MHz, 2 MHz & 1 MHz

#### Reset and Supply Management

- Power-on reset (POR) monitor/generator
- Low voltage detection (LVD) with 14 setting options (Interrupt and/or reset function)

#### LCD Controller/Driver

- Up to 35 seg x 8 com or 39 seg x 4 com
- Supports capacitor split method, internal voltage boost method and resistance division method
- Supports waveform types A and B
- Supports LCD contrast adjustment (16 steps)
- Supports LCD blinking

#### Direct Memory Access (DMA) Controller

- Up to 2 fully programmable channels
- Transfer unit: 8- or 16-bit

#### Multiple Communication Interfaces

- Up to 1 x I<sup>2</sup>C multi-master
- Up to 2 x CSI/SPI (7-, 8-bit)
- Up to 1 x UART (7-, 8-, 9-bit)
- Up to 1 x LIN

#### Extended-Function Timers

- Multi-function 16-bit timers: Up to 8 channels
- Real-time clock (RTC): 1 channel (full calendar and alarm function with watch correction function)
- Interval Timer: 12-bit, 1 channel
- 15 kHz watchdog timer: 1 channel (window function)

#### Rich Analog

- ADC: Up to 10 channels, 10-bit resolution, 2.1  $\mu$ s conversion time
- Supports 1.6 V
- Internal reference voltage (1.45 V)
- On-chip temperature sensor

#### Safety Features (IEC or UL 60730 compliance)

- Flash memory CRC calculation
- RAM parity error check
- RAM write protection
- SFR write protection
- Illegal memory access detection
- Clock frequency detection
- ADC self-test

#### General Purpose I/O

- 5V tolerant, high-current (up to 20 mA per pin)
- Open-Drain, Internal Pull-up support

#### Operating Ambient Temperature

- T<sub>A</sub>:  $-40^{\circ}\text{C}$  to  $+85^{\circ}\text{C}$  (A: Consumer applications)
- T<sub>A</sub>:  $-40^{\circ}\text{C}$  to  $+105^{\circ}\text{C}$  (G: Industrial applications)

#### Package Type and Pin Count

From 7mm x 7mm to 12mm x 12mm  
QFP: 32, 44, 48, 52, 64

## ○ ROM, RAM capacities

| Flash ROM | Data flash | RAM                    | RL78/L12 |          |          |          |          |
|-----------|------------|------------------------|----------|----------|----------|----------|----------|
|           |            |                        | 32 pins  | 44 pins  | 48 pins  | 52 pins  | 64 pins  |
| 32 KB     | 2 KB       | 1.5 KB <sup>Note</sup> | R5F10RBC | R5F10RFC | R5F10RGC | R5F10RJC | R5F10RLC |
| 16 KB     | 2 KB       | 1 KB <sup>Note</sup>   | R5F10RBA | R5F10RFA | R5F10RGA | R5F10RJA | R5F10RLA |
| 8KB       | 2 KB       | 1 KB <sup>Note</sup>   | R5F10RB8 | R5F10RF8 | R5F10RG8 | R5F10RJ8 | –        |

**Note** In the case of the 1 KB, and 1.5 KB, this is 630 bytes when the self-programming function and data flash function is used.

**Remark** The functions mounted depend on the product. See **1.6 Outline of Functions**.

1.2 List of Part Numbers

<R>

Figure 1-1. Part Number, Memory Size, and Package of RL78/L12

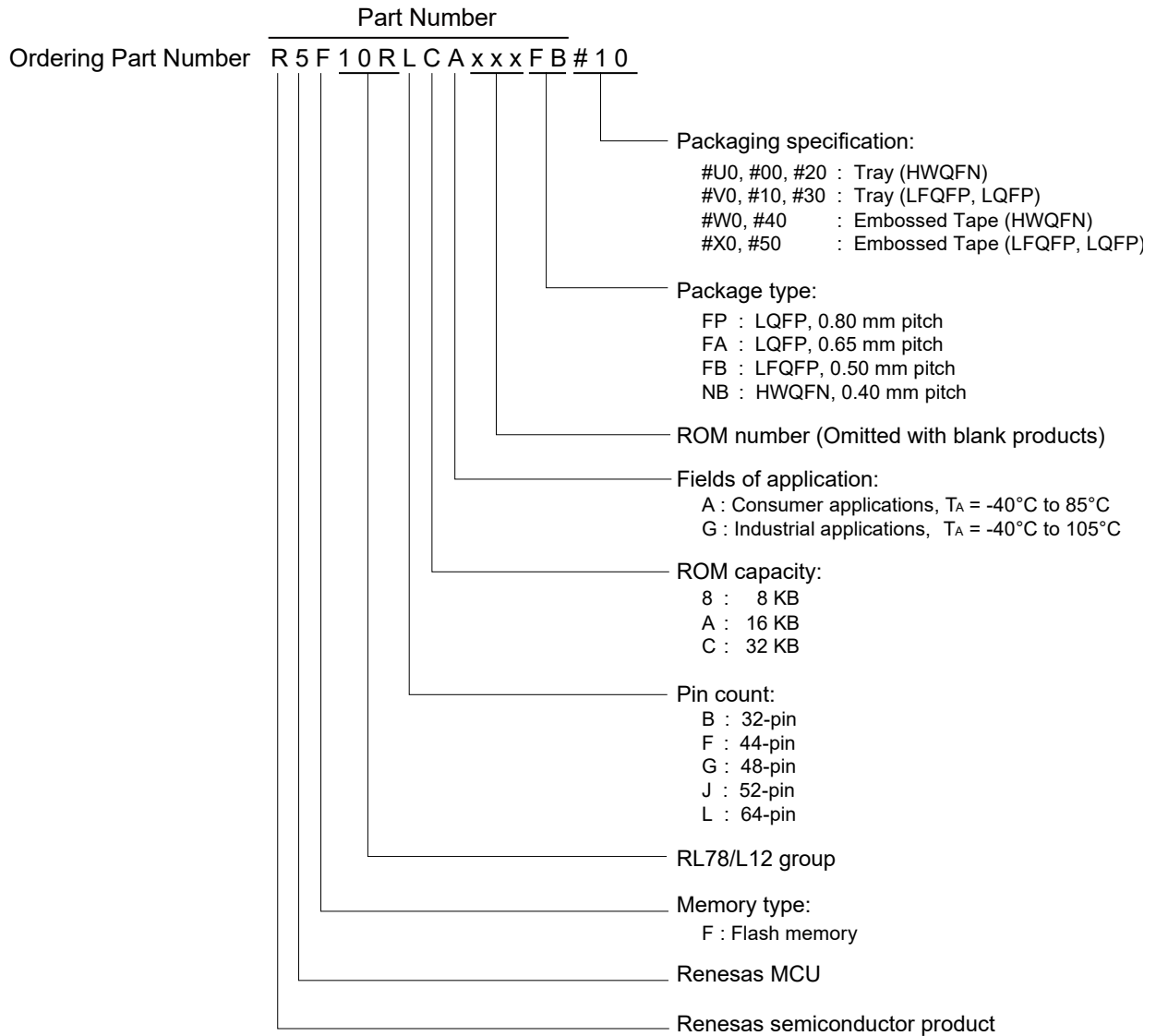

<R>

**Table 1-1. List of Ordering Part Numbers**

| Pin count | Package  | Data Flash | Fields of Application<br>Note | Ordering Part Number                     |                           | RENESAS Code                                  |
|-----------|--|------------|-------------------------------|--|---------------------------|---|
|           |  |            |                               | Part Number                              | Packaging specification   |   |
| 32 pins   | 32-pin plastic LQFP<br>(7 × 7 mm, 0.8 mm pitch)    | Mounted    | A                             | R5F10RB8AFP, R5F10RBAAFP,<br>R5F10RBCAFP | #V0, #X0<br>#10, #30, #50 | PLQP0032GB-A                                  |
|           |  |            | G                             | R5F10RB8GFP, R5F10RBAGFP,<br>R5F10RBCGFP |                           |   |
| 44 pins   | 44-pin plastic LQFP<br>(10 × 10 mm, 0.8 mm pitch)  | Mounted    | A                             | R5F10RF8AFP, R5F10RFAAFP,<br>R5F10RFCAFP | #V0, #X0<br>#10, #30, #50 | PLQP0044GC-A<br>PLQP0044GC-A/<br>PLQP0044GC-D |
|           |  |            | G                             | R5F10RF8GFP, R5F10RFAGFP,<br>R5F10RFCGFP | #V0, #X0<br>#10, #30, #50 |   |
| 48 pins   | 48-pin plastic LFQFP<br>(7 × 7 mm, 0.5 mm pitch)   | Mounted    | A                             | R5F10RG8AFB, R5F10RGAAFB,<br>R5F10RGCAPB | #V0, #X0<br>#10, #30, #50 | PLQP0048KF-A<br>PLQP0048KB-B                  |
|           |  |            | G                             | R5F10RG8GFB, R5F10RGAGFB,<br>R5F10RGCGB  | #V0, #X0<br>#10, #30, #50 |   |
| 52 pins   | 52-pin plastic LQFP<br>(10 × 10 mm, 0.65 mm pitch) | Mounted    | A                             | R5F10RJ8AFA, R5F10RJAAFA,<br>R5F10RJCAFA | #V0, #X0<br>#10, #30, #50 | PLQP0052JA-A                                  |
|           |  |            | G                             | R5F10RJ8GFA, R5F10RJAGFA,<br>R5F10RJCGFA |                           |   |
| 64 pins   | 64-pin plastic HWQFN<br>(8 × 8 mm, 0.4 mm pitch)   | Mounted    | A                             | R5F10RLAANB, R5F10RLCANB                 | #U0, #W0                  | PWQN0064LA-A                                  |
|           |  |            |                               |  | #00, #20, #40             | PWQN0064LB-A                                  |
|           |  |            | G                             | R5F10RLAGNB, R5F10RLCGNB                 | #U0, #W0<br>#00, #20, #40 | PWQN0064LA-A<br>PWQN0064LB-A                  |
|           | 64-pin plastic LFQFP<br>(10 × 10 mm, 0.5 mm pitch) | Mounted    | A                             | R5F10RLAAFB, R5F10RLCAFB                 | #V0, #X0<br>#10, #30, #50 | PLQP0064KF-A<br>PLQP0064KB-C                  |
|           |  |            | G                             | R5F10RLAGFB, R5F10RLCGFB                 | #V0, #X0<br>#10, #30, #50 |   |
|           | 64-pin plastic LQFP<br>(12 × 12 mm, 0.65 mm pitch) | Mounted    | A                             | R5F10RLAAFA, R5F10RLCAFA                 | #V0, #X0                  | PLQP0064JA-A                                  |
| G         |  |            | R5F10RLAGFA, R5F10RLCGFA      | #10, #30, #50                            |                           |   |

**Note** For the fields of application, refer to **Figure 1-1 Part Number, Memory Size, and Package of RL78/L12**.

**Caution** The ordering part numbers represent the numbers at the time of publication. For the latest ordering part numbers, refer to the target product page of the Renesas Electronics website.

### 1.3 Pin Configuration (Top View)

#### 1.3.1 32-pin products

- 32-pin plastic LQFP (7 × 7 mm, 0.8 mm pitch)

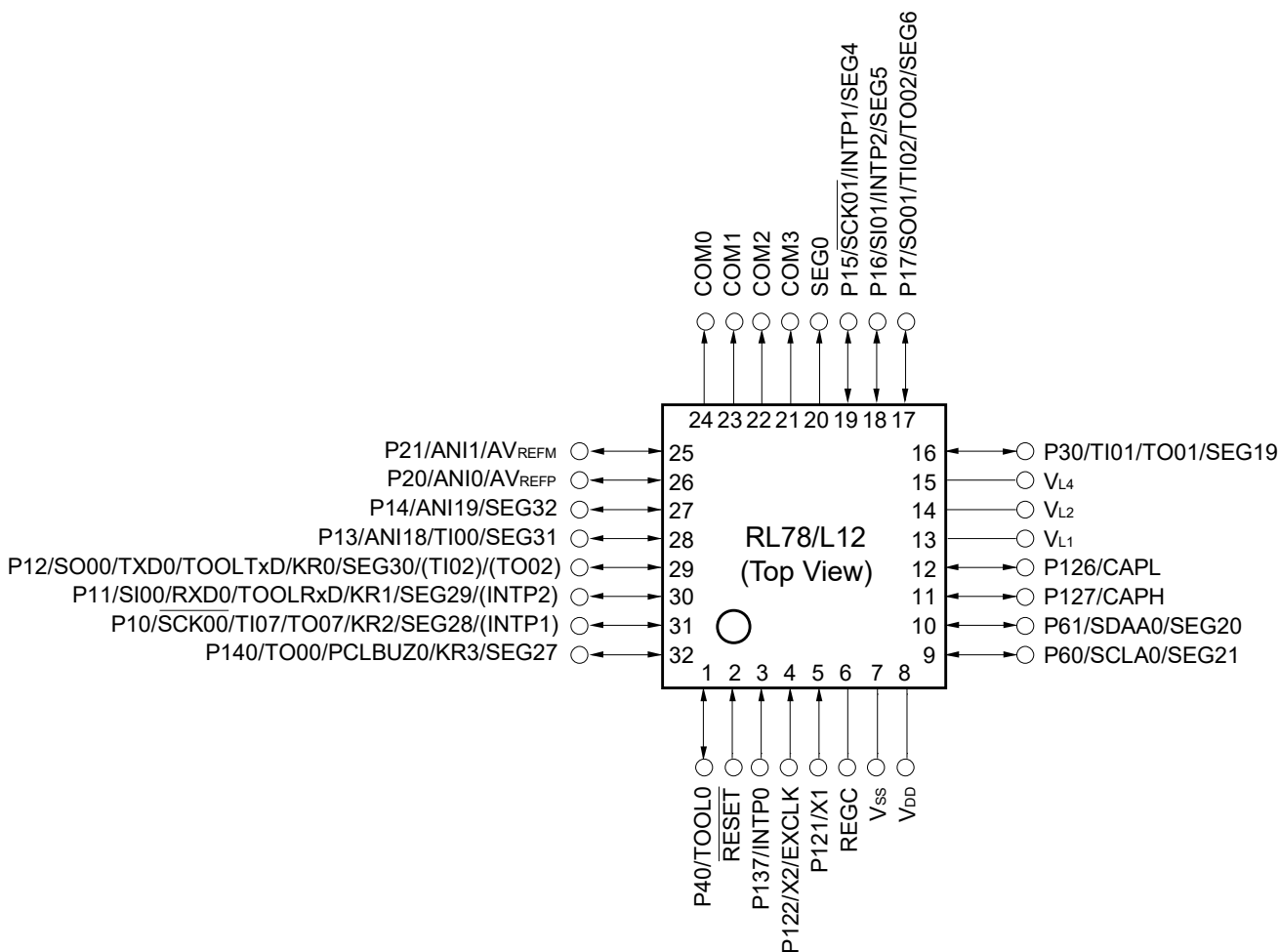

**Caution** Connect the REGC pin to V<sub>SS</sub> via a capacitor (0.47 to 1 μF).

- Remarks**
1. For pin identification, see 1.4 Pin Identification.
  2. Functions in parentheses in the above figure can be assigned via settings in the peripheral I/O redirection register (PIOR).

1.3.2 44-pin products

- 44-pin plastic LQFP (10 × 10 mm, 0.8 mm pitch)

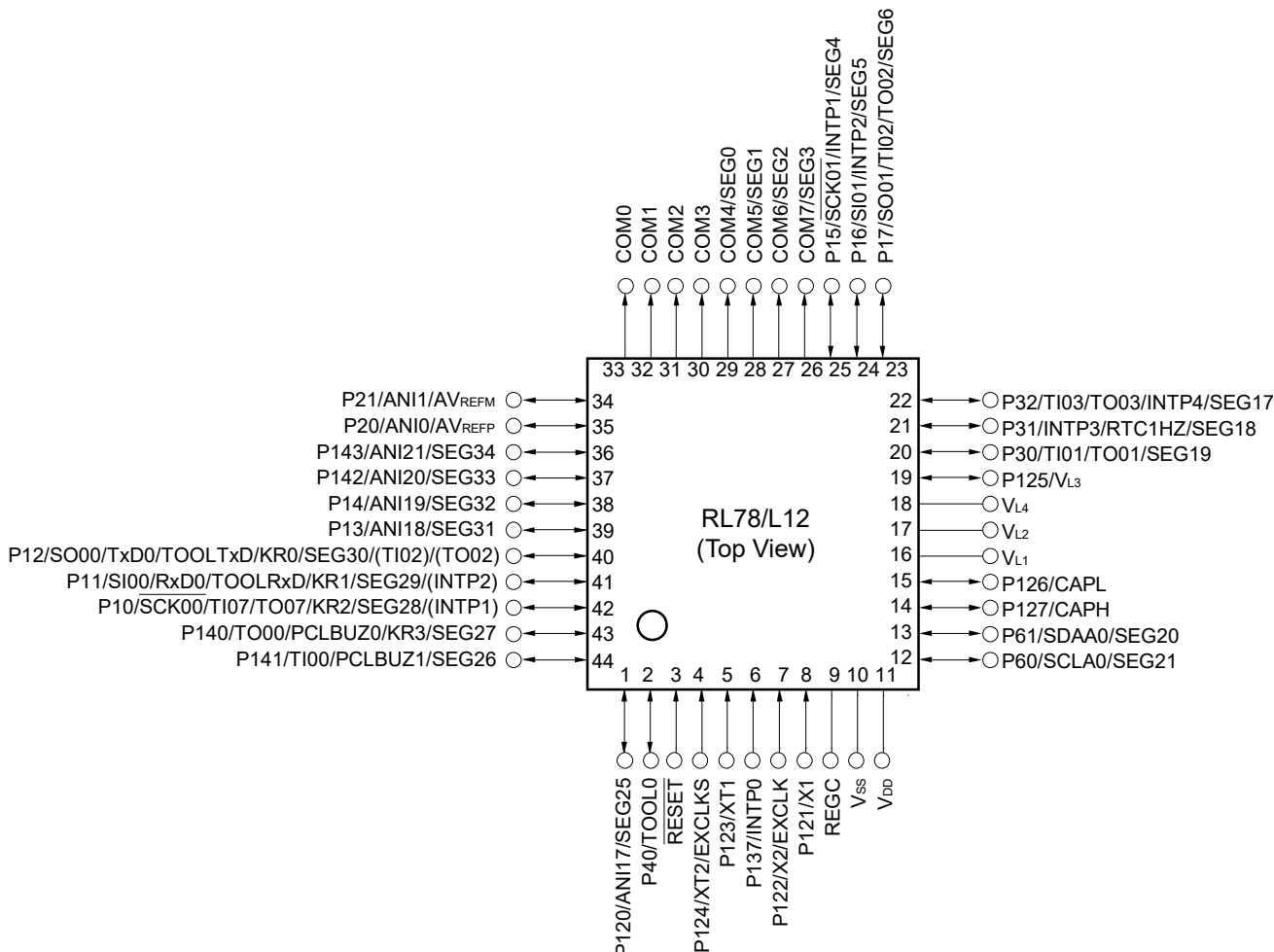

**Caution** Connect the REGC pin to V<sub>SS</sub> via a capacitor (0.47 to 1 μF).

- Remarks**
1. For pin identification, see 1.4 Pin Identification.
  2. Functions in parentheses in the above figure can be assigned via settings in the peripheral I/O redirection register (PIOR).

1.3.3 48-pin products

- 48-pin plastic LQFP (7 × 7 mm, 0.5 mm pitch)

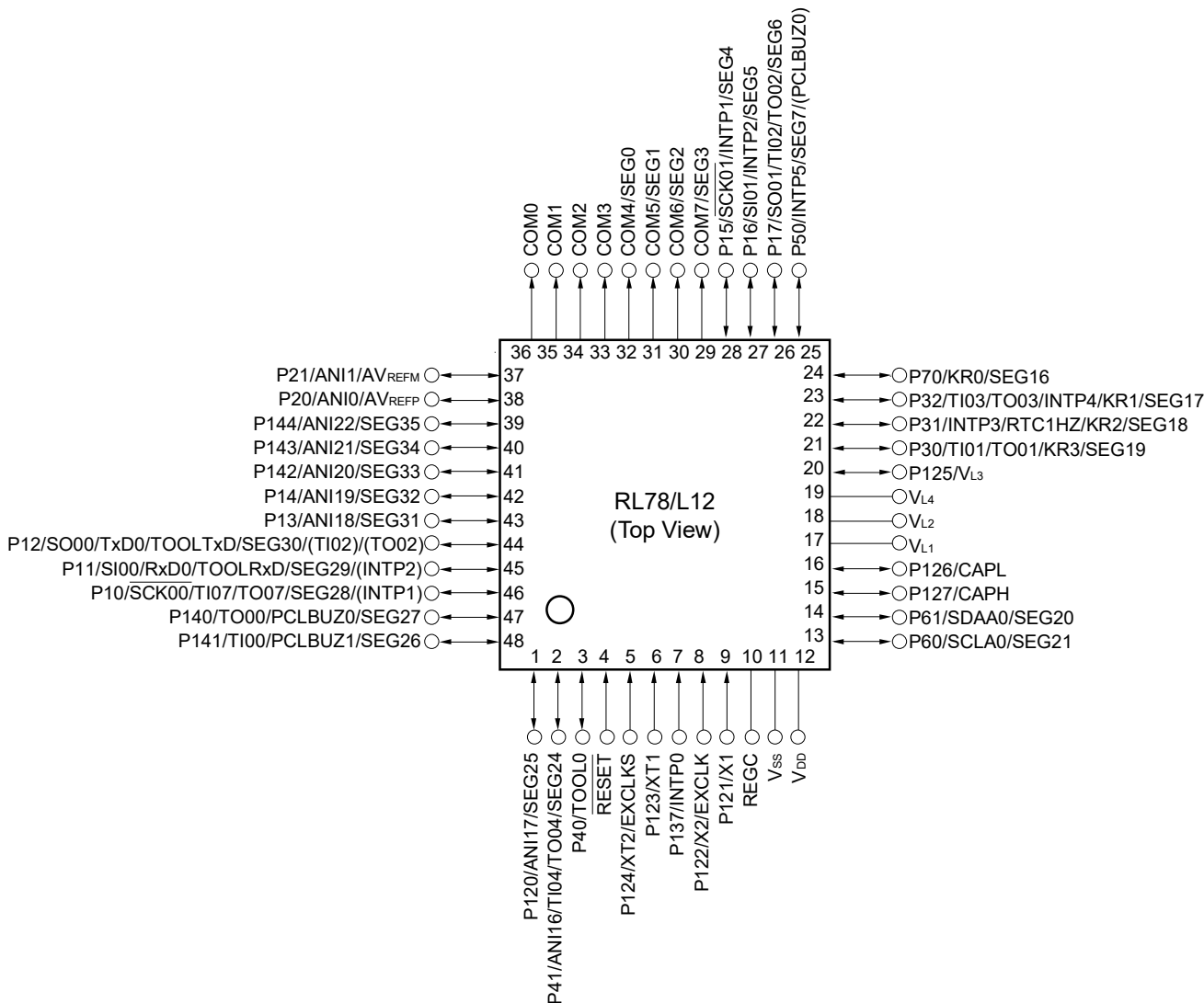

**Caution** Connect the REGC pin to V<sub>SS</sub> via a capacitor (0.47 to 1 μF).

- Remarks**
1. For pin identification, see 1.4 Pin Identification.
  2. Functions in parentheses in the above figure can be assigned via settings in the peripheral I/O redirection register (PIOR).

1.3.4 52-pin products

- 52-pin plastic LQFP (10 × 10 mm, 0.65 mm pitch)

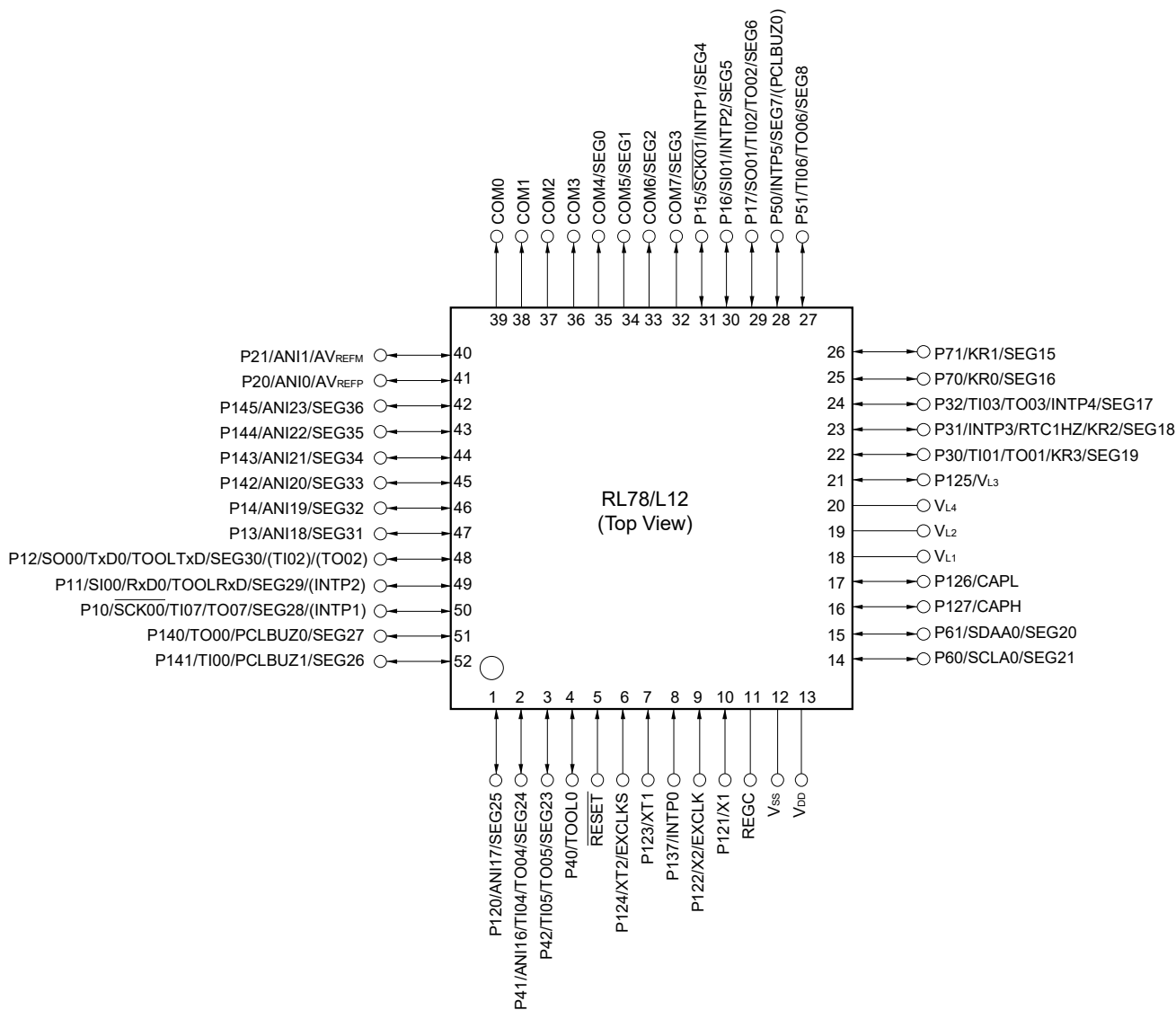

**Caution** Connect the REGC pin to V<sub>SS</sub> via a capacitor (0.47 to 1 μF).

**Remarks 1.** For pin identification, see 1.4 Pin Identification.

2. Functions in parentheses in the above figure can be assigned via settings in the peripheral I/O redirection register (PIOR).



1.3.5 64-pin products

- 64-pin plastic HWQFN (8 × 8 mm, 0.4 mm pitch)

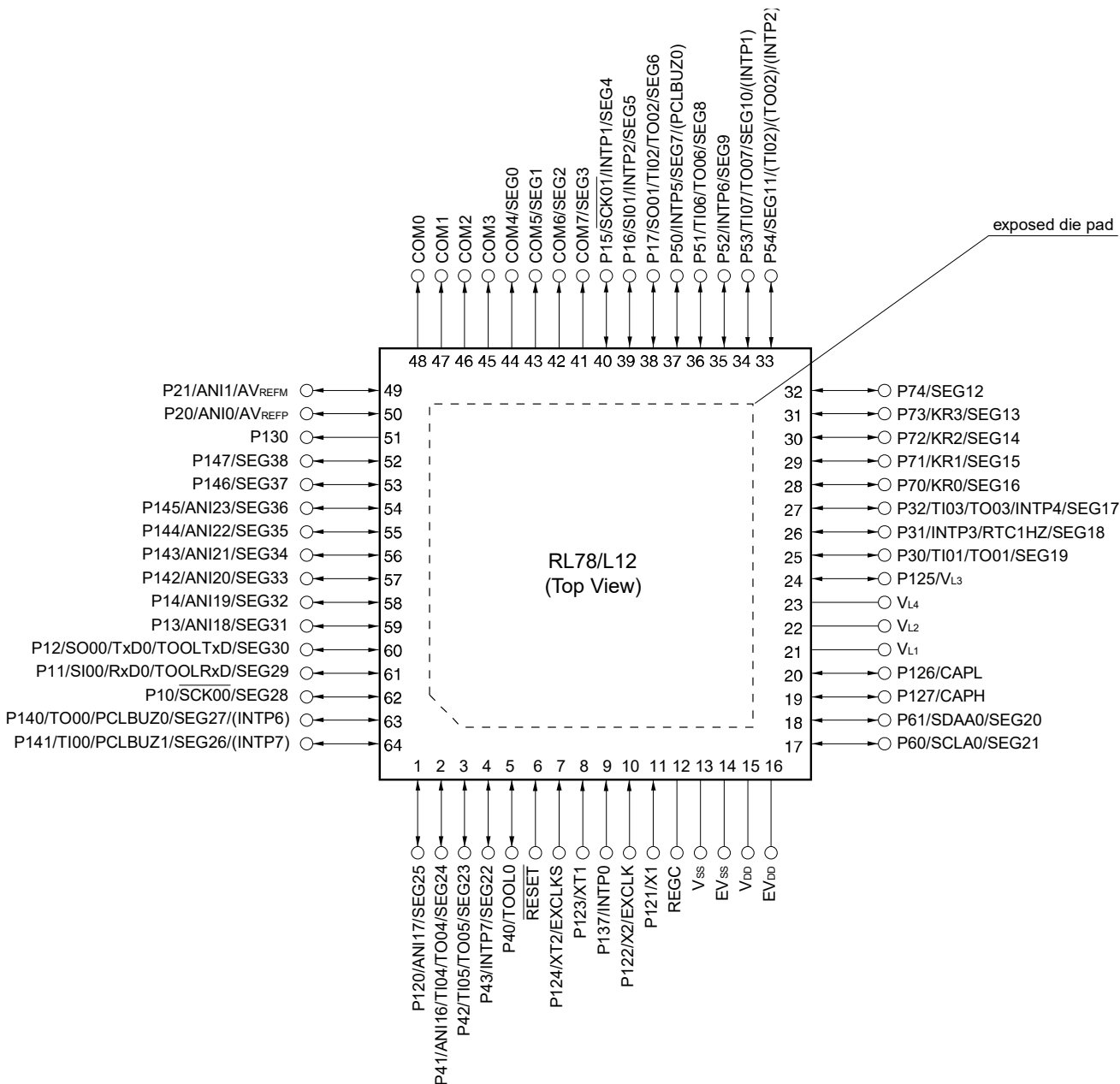

- Cautions**
1. Make EV<sub>SS</sub> pin the same potential as V<sub>SS</sub> pin.
  2. Make V<sub>DD</sub> pin the same potential as EV<sub>DD</sub> pin.
  3. Connect the REGC pin to V<sub>SS</sub> via a capacitor (0.47 to 1 μF).

- Remarks**
1. For pin identification, see 1.4 Pin Identification.
  2. When using the microcontroller for an application where the noise generated inside the microcontroller must be reduced, it is recommended to supply separate powers to the V<sub>DD</sub> and EV<sub>DD</sub> pins and connect the V<sub>SS</sub> and EV<sub>SS</sub> pins to separate ground lines.
  3. Functions in parentheses in the above figure can be assigned via settings in the peripheral I/O redirection register (PIOR).

- 64-pin plastic LQFP (10 × 10 mm, 0.5 mm pitch)
- 64-pin plastic LQFP (12 × 12 mm, 0.65 mm pitch)

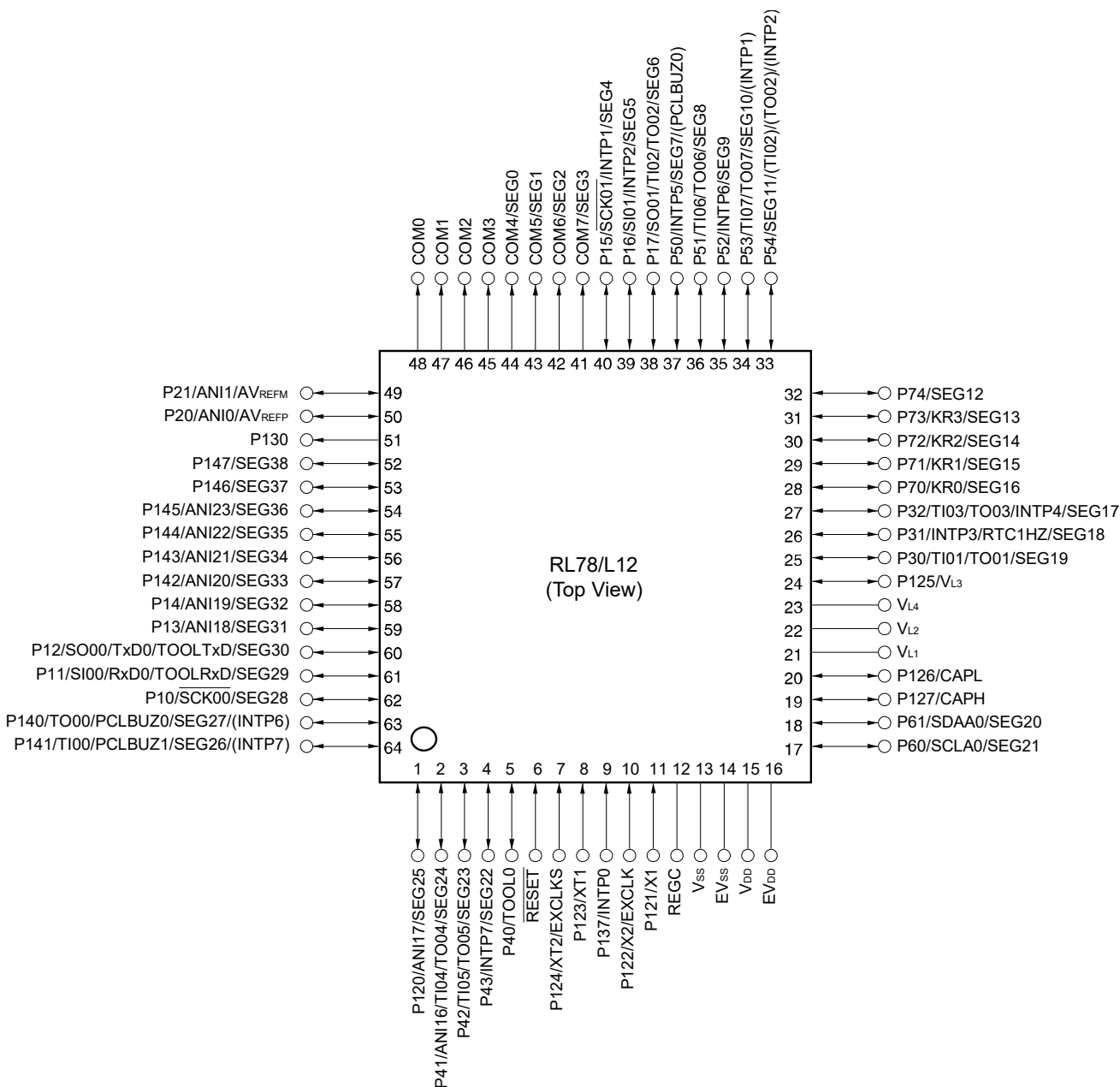

- Cautions**
1. Make EV<sub>ss</sub> pin the same potential as V<sub>ss</sub> pin.
  2. Make V<sub>DD</sub> pin the same potential as EV<sub>DD</sub> pin.
  3. Connect the REGC pin to V<sub>ss</sub> via a capacitor (0.47 to 1 μF).

- Remarks**
1. For pin identification, see 1.4 Pin Identification.
  2. When using the microcontroller for an application where the noise generated inside the microcontroller must be reduced, it is recommended to supply separate powers to the V<sub>DD</sub> and EV<sub>DD</sub> pins and connect the V<sub>ss</sub> and EV<sub>ss</sub> pins to separate ground lines.
  3. Functions in parentheses in the above figure can be assigned via settings in the peripheral I/O redirection register (PIOR).

## 1.4 Pin Identification

|                 |   |                                      |   |
|-----------------|---|--------------------------------------|---|
| ANI0, ANI1,     |   | P130, P137:                          | Port 13   |
| ANI16 to ANI23: | Analog Input                                | P140 to P147:                        | Port 14   |
| AVREFM:         | Analog Reference<br>Voltage Minus           | PCLBUZ0, PCLBUZ1:                    | Programmable Clock<br>Output/Buzzer Output        |
| AVREFP:         | Analog Reference<br>Voltage Plus            | REGC:                                | Regulator Capacitance                             |
| CAPH, CAPL:     | Capacitor for LCD                           | <u>RESET</u> :                       | Reset   |
| COM0 to COM7,   |   | RTC1HZ:                              | Real-time Clock Correction Clock<br>(1 Hz) Output |
| EVDD:           | Power Supply for Port                       | RxD0:                                | Receive Data                                      |
| EVSS:           | Ground for Port                             | <u>SCK00</u> , <u>SCK01</u> ,        |   |
| EXCLK:          | External Clock Input<br>(Main System Clock) | SCLA0:                               | Serial Clock Input/Output                         |
|                 |   | SDAA0:                               | Serial Data Input/Output                          |
| EXCLKS:         | External Clock Input<br>(Subsystem Clock)   | SEG0 to SEG38:                       | LCD Segment Output                                |
|                 |   | SI00, SI01:                          | Serial Data Input                                 |
| INTP0 to INTP7: | Interrupt Request From<br>Peripheral        | SO00, SO01:                          | Serial Data Output                                |
|                 |   | TI00 to TI07:                        | Timer Input                                       |
| KR0 to KR3:     | Key Return                                  | TO00 to TO07:                        | Timer Output                                      |
| P10 to P17:     | Port 1                                      | TOOL0:                               | Data Input/Output for Tool                        |
| P20, P21:       | Port 2                                      | TOOLRxD, TOOLTxD:                    | Data Input/Output for External Device             |
| P30 to P32:     | Port 3                                      | TxD0:                                | Transmit Data                                     |
| P40 to P43:     | Port 4                                      | V <sub>DD</sub> :                    | Power Supply                                      |
| P50 to P54:     | Port 5                                      | V <sub>L1</sub> to V <sub>L4</sub> : | LCD Power Supply                                  |
| P60, P61:       | Port 6                                      | V <sub>SS</sub> :                    | Ground  |
| P70 to P74:     | Port 7                                      | X1, X2:                              | Crystal Oscillator (Main System Clock)            |
| P120 to P127:   | Port 12                                     | XT1, XT2:                            | Crystal Oscillator (Subsystem Clock)              |

### 1.5 Block Diagram

#### 1.5.1 32-pin products

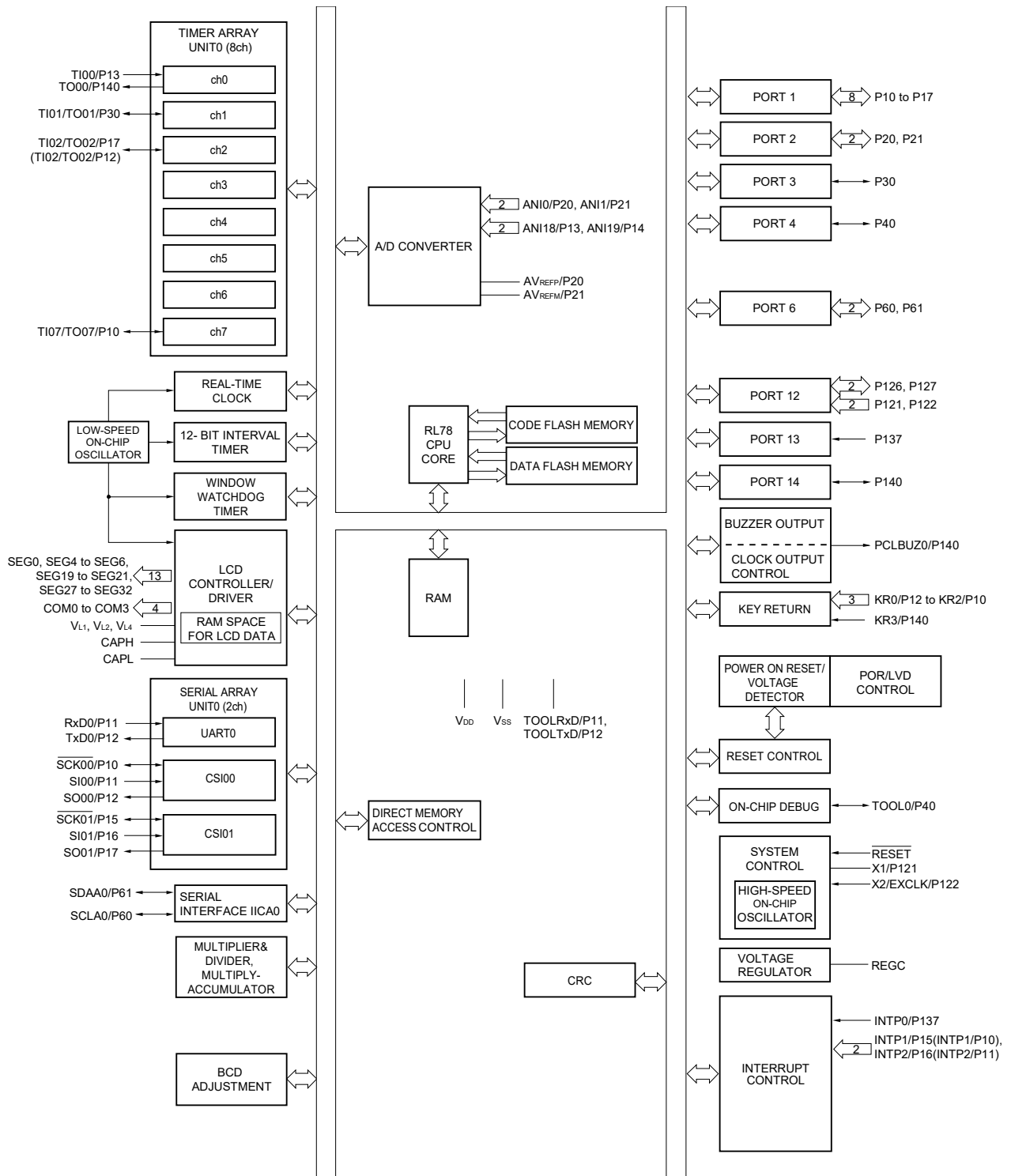

**Remark** Functions in parentheses in the above figure can be assigned via settings in the peripheral I/O redirection register (PIOR).

1.5.2 44-pin products

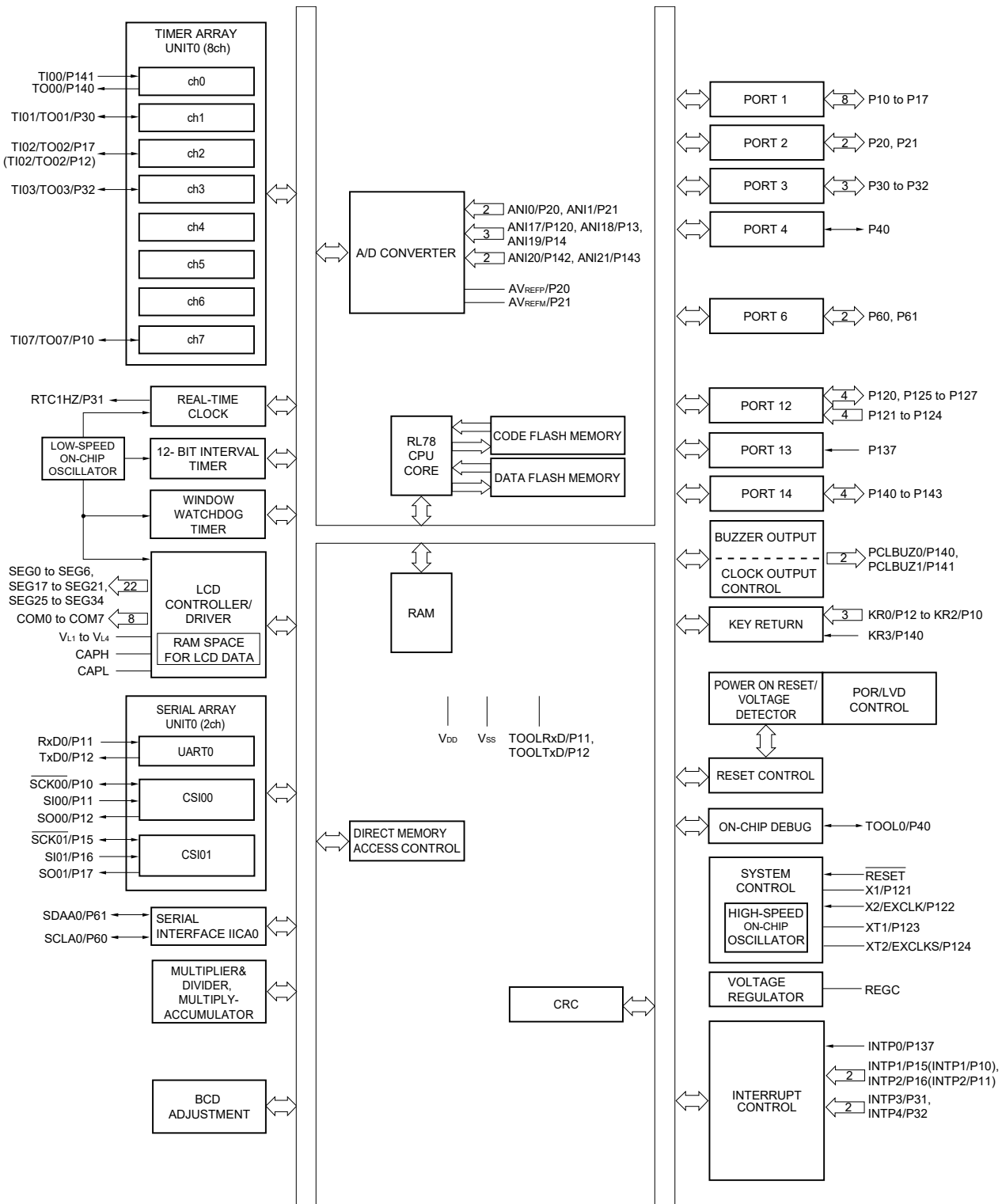

**Remark** Functions in parentheses in the above figure can be assigned via settings in the peripheral I/O redirection register (PIOR).

1.5.3 48-pin products

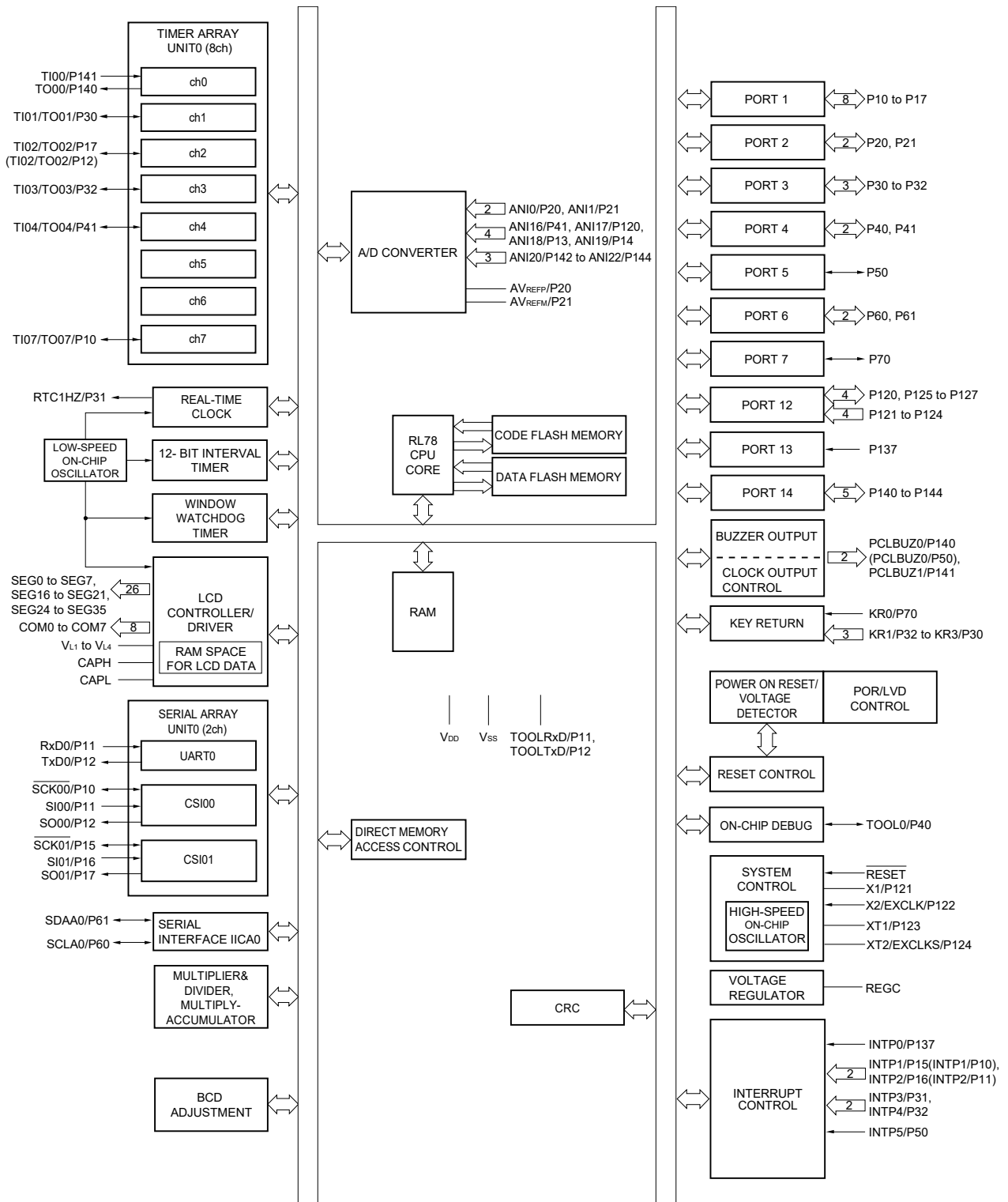

**Remark** Functions in parentheses in the above figure can be assigned via settings in the peripheral I/O redirection register (PIOR).

1.5.4 52-pin products

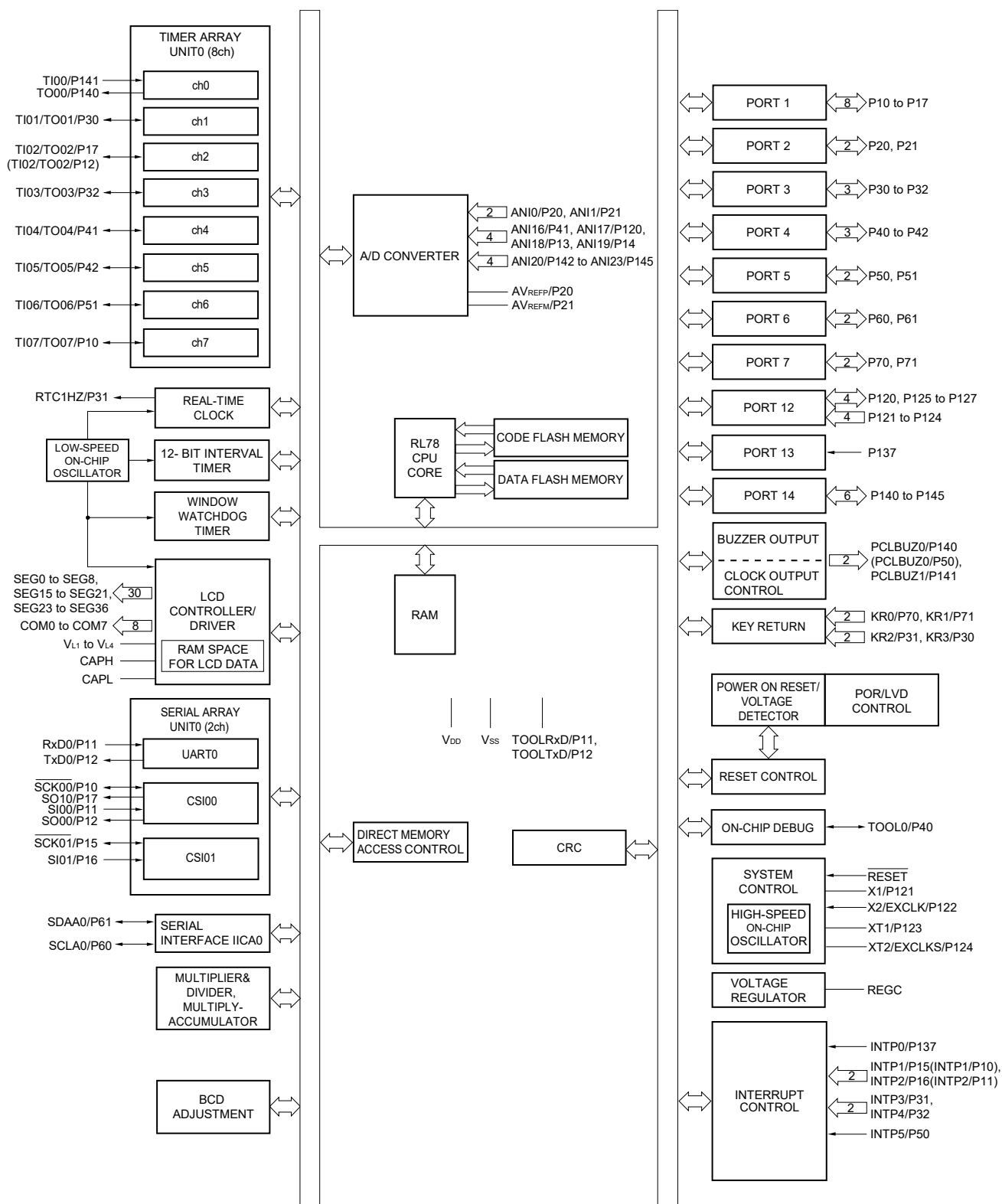

**Remark** Functions in parentheses in the above figure can be assigned via settings in the peripheral I/O redirection register (PIOR).

1.5.5 64-pin products

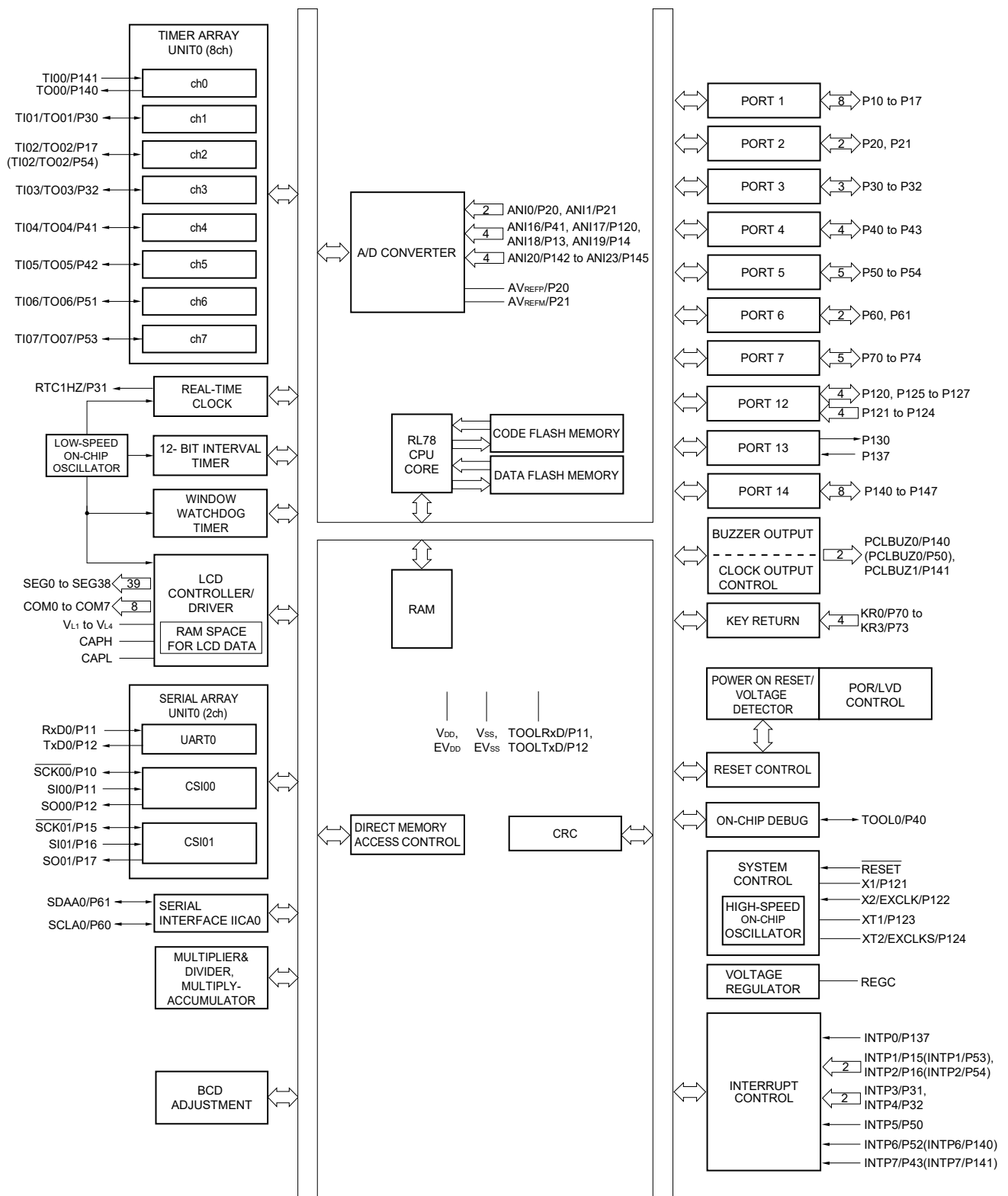

**Remark** Functions in parentheses in the above figure can be assigned via settings in the peripheral I/O redirection register (PIOR).



## 1.6 Outline of Functions

**Caution** This outline describes the functions at the time when Peripheral I/O redirection register (PIOR) is set to 00H.

| Item   |  | (1/2)   |  |                           |                           |                           |
|--|--|---|--|---------------------------|---------------------------|---------------------------|
|  |  | 32-pin<br>R5F10RBx  | 44-pin<br>R5F10RFx   | 48-pin<br>R5F10RGx        | 52-pin<br>R5F10RJx        | 64-pin<br>R5F10RLx        |
| Code flash memory (KB)   |  | 8 to 32   | 8 to 32  | 8 to 32                   | 8 to 32                   | 16, 32                    |
| Data flash memory (KB)   |  | 2   | 2  | 2                         | 2                         | 2                         |
| RAM (KB)   |  | 1, 1.5 <sup>Note 1</sup>  | 1, 1.5 <sup>Note 1</sup>   | 1, 1.5 <sup>Note 1</sup>  | 1, 1.5 <sup>Note 1</sup>  | 1, 1.5 <sup>Note 1</sup>  |
| Memory space   |  | 1 MB  |  |                           |                           |                           |
| Main system clock  | High-speed system clock                    | X1 (crystal/ceramic) oscillation, external main system clock input (EXCLK)<br>HS (high-speed main) operation: 1 to 20 MHz ( $V_{DD} = 2.7$ to 5.5 V),<br>HS (high-speed main) operation: 1 to 16 MHz ( $V_{DD} = 2.4$ to 5.5 V),<br>LS (low-speed main) operation: 1 to 8 MHz ( $V_{DD} = 1.8$ to 5.5 V),<br>LV (low-voltage main) operation: 1 to 4 MHz ( $V_{DD} = 1.6$ to 5.5 V) |  |                           |                           |                           |
|  | High-speed on-chip oscillator clock        | HS (high-speed main) operation: 1 to 24 MHz ( $V_{DD} = 2.7$ to 5.5 V),<br>HS (high-speed main) operation: 1 to 16 MHz ( $V_{DD} = 2.4$ to 5.5 V),<br>LS (low-speed main) operation: 1 to 8 MHz ( $V_{DD} = 1.8$ to 5.5 V),<br>LV (low-voltage main) operation: 1 to 4 MHz ( $V_{DD} = 1.6$ to 5.5 V)   |  |                           |                           |                           |
| Subsystem clock  |  | –   | XT1 (crystal) oscillation, external subsystem clock input (EXCLKS)<br>32.768 kHz (TYP.): $V_{DD} = 1.6$ to 5.5 V |                           |                           |                           |
| Low-speed on-chip oscillator clock                               |  | Internal oscillation<br>15 kHz (TYP.): $V_{DD} = 1.6$ to 5.5 V  |  |                           |                           |                           |
| General-purpose register   |  | 8 bits × 32 registers (8 bits × 8 registers × 4 banks)  |  |                           |                           |                           |
| Minimum instruction execution time                               |  | 0.04167 $\mu$ s (High-speed on-chip oscillator clock: $f_{IH} = 24$ MHz operation)  |  |                           |                           |                           |
|  |  | 0.05 $\mu$ s (High-speed system clock: $f_{MX} = 20$ MHz operation)   |  |                           |                           |                           |
|  |  | 30.5 $\mu$ s (Subsystem clock: $f_{SUB} = 32.768$ kHz operation)  |  |                           |                           |                           |
| Instruction set  |  | <ul style="list-style-type: none"> <li>• Data transfer (8/16 bits)</li> <li>• Adder and subtractor/logical operation (8/16 bits)</li> <li>• Multiplication (8 bits × 8 bits)</li> <li>• Rotate, barrel shift, and bit manipulation (Set, reset, test, and Boolean operation), etc.</li> </ul>   |  |                           |                           |                           |
| Total number of I/O port pins and pins dedicated to drive an LCD |  | 28  | 40   | 44                        | 48                        | 58                        |
| I/O port   | Total                                      | 20  | 29   | 33                        | 37                        | 47                        |
|  | CMOS I/O                                   | 15  | 22   | 26                        | 30                        | 39                        |
|  | CMOS input                                 | 3   | 5  | 5                         | 5                         | 5                         |
|  | CMOS output                                | –   | –  | –                         | –                         | 1                         |
|  | N-ch open-drain I/O ( $E_{VDD}$ tolerance) | 2   | 2  | 2                         | 2                         | 2                         |
| Pins dedicated to drive an LCD                                   |  | 8   | 11   | 11                        | 11                        | 11                        |
| LCD controller/driver  |  | Internal voltage boosting method, capacitor split method, and external resistance division method are switchable.   |  |                           |                           |                           |
| Segment signal output  |  | 13  | 22 (18) <sup>Note 2</sup>  | 26 (22) <sup>Note 2</sup> | 30 (26) <sup>Note 2</sup> | 39 (35) <sup>Note 2</sup> |
| Common signal output   |  | 4   | 4 (8) <sup>Note 2</sup>  |                           |                           |                           |

**Notes** 1. In the case of the 1 KB, and 1.5 KB, this is 630 bytes when the self-programming function and data flash function is used.

2. The values in parentheses are the number of signal outputs when 8 com is used.

(2/2)

| Item  |                            | 32-pin  | 44-pin  | 48-pin   | 52-pin   | 64-pin      |
|---|----------------------------|---|---|--|--|-------------|
|   |                            | R5F10RBx  | R5F10RFx  | R5F10RGx   | R5F10RJx                                       | R5F10RLx    |
| Timer                                       | 16-bit timer               | 8 channels  | 8 channels (with 1 channel remote control output function)  |  |  |             |
|   | Watchdog timer             | 1 channel   |   |  |  |             |
|   | Real-time clock (RTC)      | 1 channel   |   |  |  |             |
|   | 12-bit interval timer (IT) | 1 channel   |   |  |  |             |
|   | Timer output               | 4 channels<br>(PWM outputs:<br>3 <sup>Note 1</sup> )  | 5 channels<br>(PWM outputs:<br>4 <sup>Note 1</sup> )  | 6 channels<br>(PWM outputs:<br>5 <sup>Note 1</sup> ) | 8 channels (PWM outputs: 7 <sup>Note 1</sup> ) |             |
|   | RTC output                 | –   | 1<br>• 1 Hz (subsystem clock: $f_{SUB} = 32.768$ kHz)   |  |  |             |
| Clock output/buzzer output                  |                            | 1   | 2<br>• 2.44 kHz, 4.88 kHz, 9.76 kHz, 1.25 MHz, 2.5 MHz, 5 MHz, 10 MHz<br>(Main system clock: $f_{MAIN} = 20$ MHz operation)<br>• 256 Hz, 512 Hz, 1.024 kHz, 2.048 kHz, 4.096 kHz, 8.192 kHz, 16.384 kHz,<br>32.768 kHz<br>(Subsystem clock: $f_{SUB} = 32.768$ kHz operation) |  |  |             |
| 8/10-bit resolution A/D converter           |                            | 4 channels  | 7 channels  | 9 channels   | 10 channels                                    | 10 channels |
| Serial interface                            |                            | • CSI: 2 channel/UART (LIN-bus supported): 1 channel  |   |  |  |             |
|   | I <sup>2</sup> C bus       | 1 channel   | 1 channel   | 1 channel  | 1 channel                                      | 1 channel   |
| Multiplier and divider/multiply-accumulator |                            | • 16 bits × 16 bits = 32 bits (Unsigned or signed)<br>• 32 bits ÷ 32 bits = 32 bits (Unsigned)<br>• 16 bits × 16 bits + 32 bits = 32 bits (Unsigned or signed)  |   |  |  |             |
| DMA controller                              |                            | 2 channels  |   |  |  |             |
| Vectored interrupt sources                  | Internal                   | 23  | 23  | 23   | 23   | 23          |
|   | External                   | 4   | 6   | 7  | 7  | 9           |
| Key interrupt                               |                            | 4   |   |  |  |             |
| Reset                                       |                            | • Reset by $\overline{RESET}$ pin<br>• Internal reset by watchdog timer<br>• Internal reset by power-on-reset<br>• Internal reset by voltage detector<br>• Internal reset by illegal instruction execution <sup>Note 2</sup><br>• Internal reset by RAM parity error<br>• Internal reset by illegal-memory access |   |  |  |             |
| Power-on-reset circuit                      |                            | • Power-on-reset: 1.51 ±0.04 V<br>• Power-down-reset: 1.50 ±0.04 V  |   |  |  |             |
| Voltage detector                            |                            | • Rising edge : 1.67 V to 4.06 V (14 stages)<br>• Falling edge : 1.63 V to 3.98 V (14 stages)   |   |  |  |             |
| On-chip debug function                      |                            | Provided  |   |  |  |             |
| Power supply voltage                        |                            | $V_{DD} = 1.6$ to 5.5 V   |   |  |  |             |
| Operating ambient temperature               |                            | $T_A = -40$ to +85 °C   |   |  |  |             |

**Notes** 1. The number of PWM outputs varies depending on the setting of channels in use (the number of masters and slaves).

2. The illegal instruction is generated when instruction code FFH is executed.

Reset by the illegal instruction execution not issued by emulation with the in-circuit emulator or on-chip debug emulator.

## 2. ELECTRICAL SPECIFICATIONS (A, G: T<sub>A</sub> = -40 to +85°C)

This chapter describes the electrical specifications for the products "A: Consumer applications (T<sub>A</sub> = -40 to +85°C)" and "G: Industrial applications (with T<sub>A</sub> = -40 to +85°C)".

- Cautions**
- 1. The RL78 microcontrollers have an on-chip debug function, which is provided for development and evaluation. Do not use the on-chip debug function in products designated for mass production, because the guaranteed number of rewritable times of the flash memory may be exceeded when this function is used, and product reliability therefore cannot be guaranteed. Renesas Electronics is not liable for problems occurring when the on-chip debug function is used.**
  - 2. With products not provided with an EV<sub>DD</sub>, or EV<sub>SS</sub> pin, replace EV<sub>DD</sub> with V<sub>DD</sub>, or replace EV<sub>SS</sub> with V<sub>SS</sub>.**

## 2.1 Absolute Maximum Ratings

Absolute Maximum Ratings (T<sub>A</sub> = 25°C)

(1/3)

| Parameter              | Symbols            | Conditions   | Ratings   | Unit |
|------------------------|--------------------|--|---|------|
| Supply voltage         | V <sub>DD</sub>    | V <sub>DD</sub> = EV <sub>DD</sub>   | -0.5 to +6.5  | V    |
|                        | EV <sub>DD</sub>   | V <sub>DD</sub> = EV <sub>DD</sub>   | -0.5 to +6.5  | V    |
|                        | EV <sub>SS</sub>   |  | -0.5 to +0.3  | V    |
| REGC pin input voltage | V <sub>IREGC</sub> | REGC   | -0.3 to +2.8<br>and -0.3 to V <sub>DD</sub> + 0.3 <sup>Note 1</sup>                           | V    |
| Input voltage          | V <sub>I1</sub>    | P10 to P17, P30 to P32, P40 to P43, P50 to P54,<br>P70 to P74, P120, P125 to P127, P140 to P147                    | -0.3 to EV <sub>DD</sub> + 0.3<br>and -0.3 to V <sub>DD</sub> + 0.3 <sup>Note 2</sup>         | V    |
|                        | V <sub>I2</sub>    | P60, P61 (N-ch open-drain)   | -0.3 to EV <sub>DD</sub> + 0.3<br>and -0.3 to V <sub>DD</sub> + 0.3 <sup>Note 2</sup>         | V    |
|                        | V <sub>I3</sub>    | P20, P21, P121 to P124, P137, EXCLK,<br>EXCLKS, RESET  | -0.3 to V <sub>DD</sub> + 0.3 <sup>Note 2</sup>   | V    |
| Output voltage         | V <sub>O1</sub>    | P10 to P17, P30 to P32, P40 to P43,<br>P50 to P54, P60, P61, P70 to P74, P120,<br>P125 to P127, P130, P140 to P147 | -0.3 to EV <sub>DD</sub> + 0.3<br>and -0.3 to V <sub>DD</sub> + 0.3 <sup>Note 2</sup>         | V    |
|                        | V <sub>O2</sub>    | P20, P21   | -0.3 to V <sub>DD</sub> + 0.3 <sup>Note 2</sup>   | V    |
| Analog input voltage   | V <sub>AI1</sub>   | ANI16 to ANI23   | -0.3 to EV <sub>DD</sub> + 0.3 and<br>-0.3 to AV <sub>REF(+)</sub> + 0.3<br><b>Notes 2, 3</b> | V    |
|                        | V <sub>AI2</sub>   | ANI0, ANI1   | -0.3 to V <sub>DD</sub> + 0.3 and<br>-0.3 to AV <sub>REF(+)</sub> + 0.3<br><b>Notes 2, 3</b>  | V    |

- Notes 1.** Connect the REGC pin to V<sub>SS</sub> via a capacitor (0.47 to 1 μF). This value regulates the absolute maximum rating of the REGC pin. Do not use this pin with voltage applied to it.
2. Must be 6.5 V or lower.
  3. Do not exceed AV<sub>REF(+)</sub> + 0.3 V in case of A/D conversion target pin.

**Caution** Product quality may suffer if the absolute maximum rating is exceeded even momentarily for any parameter. That is, the absolute maximum ratings are rated values at which the product is on the verge of suffering physical damage, and therefore the product must be used under conditions that ensure that the absolute maximum ratings are not exceeded.

- Remarks 1.** Unless specified otherwise, the characteristics of alternate-function pins are the same as those of the port pins.
2. AV<sub>REF(+)</sub> : + side reference voltage of the A/D converter.
  3. V<sub>SS</sub> : Reference voltage

**Absolute Maximum Ratings (T<sub>A</sub> = 25°C)****(2/3)**

| Parameter   | Symbols                          | Conditions   | Ratings   | Unit  |
|-------------|----------------------------------|--|---|---|
| LCD voltage | V <sub>L1</sub>                  | V <sub>L1</sub> voltage <sup>Note 1</sup>            | -0.3 to +2.8<br>and -0.3 to V <sub>L4</sub> + 0.3 | V   |
|             | V <sub>L2</sub>                  | V <sub>L2</sub> voltage <sup>Note 1</sup>            | -0.3 to V <sub>L4</sub> + 0.3 <sup>Note 2</sup>   | V   |
|             | V <sub>L3</sub>                  | V <sub>L3</sub> voltage <sup>Note 1</sup>            | -0.3 to V <sub>L4</sub> + 0.3 <sup>Note 2</sup>   | V   |
|             | V <sub>L4</sub>                  | V <sub>L4</sub> voltage <sup>Note 1</sup>            | -0.3 to +6.5                                      | V   |
|             | V <sub>LCAP</sub>                | CAPL, CAPH voltage <sup>Note 1</sup>                 | -0.3 to V <sub>L4</sub> + 0.3 <sup>Note 2</sup>   | V   |
|             | V <sub>LOUT</sub>                | COM0 to COM7,<br>SEG0 to<br>SEG38,<br>output voltage | External resistance division<br>method            | -0.3 to V <sub>DD</sub> + 0.3 <sup>Note 2</sup> |
|             | Capacitor split method           |  | -0.3 to V <sub>DD</sub> + 0.3 <sup>Note 2</sup>   |   |
|             | Internal voltage boosting method |  | -0.3 to V <sub>L4</sub> + 0.3 <sup>Note 2</sup>   |   |

**Notes 1.** This value only indicates the absolute maximum ratings when applying voltage to the V<sub>L1</sub>, V<sub>L2</sub>, V<sub>L3</sub>, and V<sub>L4</sub> pins; it does not mean that applying voltage to these pins is recommended. When using the internal voltage boosting method or capacitance split method, connect these pins to V<sub>SS</sub> via a capacitor (0.47 μF ± 30%) and connect a capacitor (0.47 μF ± 30%) between the CAPL and CAPH pins.

**2.** Must be 6.5 V or lower.

**Caution** Product quality may suffer if the absolute maximum rating is exceeded even momentarily for any parameter. That is, the absolute maximum ratings are rated values at which the product is on the verge of suffering physical damage, and therefore the product must be used under conditions that ensure that the absolute maximum ratings are not exceeded.

**Remark** V<sub>SS</sub> : Reference voltage

**Absolute Maximum Ratings (T<sub>A</sub> = 25°C)****(3/3)**

| Parameter                     | Symbols          | Conditions                       |  | Ratings     | Unit |
|-------------------------------|------------------|----------------------------------|--|-------------|------|
| Output current, high          | I <sub>OH1</sub> | Per pin                          | P10 to P17, P30 to P32, P40 to P43, P50 to P54, P70 to P74, P120, P125 to P127, P130, P140 to P147           | -40         | mA   |
|                               |                  | Total of all pins<br>-170 mA     | P10 to P14, P40 to P43, P120, P130, P140 to P147   | -70         | mA   |
|                               |                  |                                  | P15 to P17, P30 to P32, P50 to P54, P70 to P74, P125 to P127   | -100        | mA   |
|                               | I <sub>OH2</sub> | Per pin                          | P20, P21   | -0.5        | mA   |
|                               |                  | Total of all pins                |  | -1          | mA   |
| Output current, low           | I <sub>OL1</sub> | Per pin                          | P10 to P17, P30 to P32, P40 to P43, P50 to P54, P60, P61, P70 to P74, P120, P125 to P127, P130, P140 to P147 | 40          | mA   |
|                               |                  | Total of all pins<br>170 mA      | P10 to P14, P40 to P43, P120, P130, P140 to P147   | 70          | mA   |
|                               |                  |                                  | P15 to P17, P30 to P32, P50 to P54, P60, P61, P70 to P74, P125 to P127                                       | 100         | mA   |
|                               | I <sub>OL2</sub> | Per pin                          | P20, P21   | 1           | mA   |
|                               |                  | Total of all pins                |  | 2           | mA   |
| Operating ambient temperature | T <sub>A</sub>   | In normal operation mode         |  | -40 to +85  | °C   |
|                               |                  | In flash memory programming mode |  |             |      |
| Storage temperature           | T <sub>stg</sub> |                                  |  | -65 to +150 | °C   |

**Caution** Product quality may suffer if the absolute maximum rating is exceeded even momentarily for any parameter. That is, the absolute maximum ratings are rated values at which the product is on the verge of suffering physical damage, and therefore the product must be used under conditions that ensure that the absolute maximum ratings are not exceeded.

**Remark** Unless specified otherwise, the characteristics of alternate-function pins are the same as those of the port pins.

## 2.2 Oscillator Characteristics

### 2.2.1 X1, XT1 oscillator characteristics

(T<sub>A</sub> = -40 to +85°C, 1.6 V ≤ EV<sub>DD</sub> = V<sub>DD</sub> ≤ 5.5 V, V<sub>SS</sub> = EV<sub>SS</sub> = 0 V)

| Parameter  | Resonator                               | Conditions                      | MIN. | TYP.   | MAX. | Unit |
|--|---|---------------------------------|------|--------|------|------|
| X1 clock oscillation frequency (f <sub>X</sub> ) <sup>Note</sup>   | Ceramic resonator/<br>crystal resonator | 2.7 V ≤ V <sub>DD</sub> ≤ 5.5 V | 1.0  |        | 20.0 | MHz  |
|  |   | 2.4 V ≤ V <sub>DD</sub> ≤ 2.7 V | 1.0  |        | 16.0 | MHz  |
|  |   | 1.8 V ≤ V <sub>DD</sub> < 2.7 V | 1.0  |        | 8.0  | MHz  |
|  |   | 1.6 V ≤ V <sub>DD</sub> < 1.8 V | 1.0  |        | 4.0  | MHz  |
| XT1 clock oscillation frequency (f <sub>XT</sub> ) <sup>Note</sup> | Crystal resonator                       |                                 | 32   | 32.768 | 35   | kHz  |

**Note** Indicates only permissible oscillator frequency ranges. Refer to **2.4 AC Characteristics** for instruction execution time. Request evaluation by the manufacturer of the oscillator circuit mounted on a board to check the oscillator characteristics.

**Caution** Since the CPU is started by the high-speed on-chip oscillator clock after a reset release, check the X1 clock oscillation stabilization time using the oscillation stabilization time counter status register (OSTC) by the user. Determine the oscillation stabilization time of the OSTC register and the oscillation stabilization time select register (OSTS) after sufficiently evaluating the oscillation stabilization time with the resonator to be used.

### 2.2.2 On-chip oscillator characteristics

(T<sub>A</sub> = -40 to +85°C, 1.6 V ≤ EV<sub>DD</sub> = V<sub>DD</sub> ≤ 5.5 V, V<sub>SS</sub> = EV<sub>SS</sub> = 0 V)

| Oscillators   | Parameters     | Conditions   |                                 | MIN. | TYP. | MAX. | Unit |
|---|----------------|--------------|---------------------------------|------|------|------|------|
| High-speed on-chip oscillator clock frequency <sup>Notes 1, 2</sup> | f <sub>H</sub> |              |                                 | 1    |      | 24   | MHz  |
| High-speed on-chip oscillator clock frequency accuracy              |                | -20 to +85°C | 1.8 V ≤ V <sub>DD</sub> ≤ 5.5 V | -1   |      | +1   | %    |
|   |                |              | 1.6 V ≤ V <sub>DD</sub> < 1.8 V | -5   |      | +5   | %    |
|   |                | -40 to -20°C | 1.8 V ≤ V <sub>DD</sub> ≤ 5.5 V | -1.5 |      | +1.5 | %    |
|   |                |              | 1.6 V ≤ V <sub>DD</sub> < 1.8 V | -5.5 |      | +5.5 | %    |
| Low-speed on-chip oscillator clock frequency                        | f <sub>L</sub> |              |                                 |      | 15   |      | kHz  |
| Low-speed on-chip oscillator clock frequency accuracy               |                |              |                                 | -15  |      | +15  | %    |

**Notes 1.** High-speed on-chip oscillator frequency is selected by bits 0 to 3 of option byte (000C2H) and bits 0 to 2 of HOCODIV register.

**2.** This indicates the oscillator characteristics only. Refer to **2.4 AC Characteristics** for instruction execution time.

## 2.3 DC Characteristics

## 2.3.1 Pin characteristics

(T<sub>A</sub> = -40 to +85°C, 1.6 V ≤ EV<sub>DD</sub> = V<sub>DD</sub> ≤ 5.5 V, V<sub>SS</sub> = EV<sub>SS</sub> = 0 V)

(1/5)

| Items                                  | Symbol           | Conditions   | MIN.                             | TYP. | MAX.            | Unit  |        |
|--|------------------|--|----------------------------------|------|-----------------|-------|--------|
| Output current, high <sup>Note 1</sup> | I <sub>OH1</sub> | Per pin for P10 to P17, P30 to P32, P40 to P43, P50 to P54, P70 to P74, P120, P125 to P127, P130, P140 to P147 |                                  |      | -10.0<br>Note 2 | mA    |        |
|  |                  | Total of P10 to P14, P40 to P43, P120, P130, P140 to P147<br>(When duty = 70% <sup>Note 3</sup> )              | 4.0 V ≤ EV <sub>DD</sub> ≤ 5.5 V |      |                 | -40.0 | mA     |
|  |                  |  | 2.7 V ≤ EV <sub>DD</sub> < 4.0 V |      |                 | -8.0  | mA     |
|  |                  |  | 1.8 V ≤ EV <sub>DD</sub> < 2.7 V |      |                 | -4.0  | mA     |
|  |                  |  | 1.6 V ≤ EV <sub>DD</sub> < 1.8 V |      |                 | -2.0  | mA     |
|  |                  | Total of P15 to P17, P30 to P32, P50 to P54, P70 to P74, P125 to P127<br>(When duty = 70% <sup>Note 3</sup> )  | 4.0 V ≤ EV <sub>DD</sub> ≤ 5.5 V |      |                 | -60.0 | mA     |
|  |                  |  | 2.7 V ≤ EV <sub>DD</sub> < 4.0 V |      |                 | -15.0 | mA     |
|  |                  |  | 1.8 V ≤ EV <sub>DD</sub> < 2.7 V |      |                 | -8.0  | mA     |
|  |                  |  | 1.6 V ≤ EV <sub>DD</sub> < 1.8 V |      |                 | -4.0  | mA     |
|  |                  | Total of all pins<br>(When duty = 70% <sup>Note 3</sup> )  |                                  |      |                 |       | -100.0 |
| I <sub>OH2</sub>                       | P20, P21         | Per pin  |                                  |      | -0.1            | mA    |        |
|  |                  | Total of all pins  | 1.6 V ≤ V <sub>DD</sub> ≤ 5.5 V  |      |                 | -0.2  | mA     |

**Notes** 1. Value of current at which the device operation is guaranteed even if the current flows from the V<sub>DD</sub> and EV<sub>DD</sub> pins to an output pin.

2. Do not exceed the total current value.

3. Specification under conditions where the duty factor ≤ 70%.

The output current value that has changed to the duty factor > 70% the duty ratio can be calculated with the following expression (when changing the duty factor from 70% to n%).

- Total output current of pins = (I<sub>OH</sub> × 0.7)/(n × 0.01)

<Example> Where n = 80% and I<sub>OH</sub> = -40.0 mA

$$\text{Total output current of pins} = (-40.0 \times 0.7)/(80 \times 0.01) \cong -35.0 \text{ mA}$$

However, the current that is allowed to flow into one pin does not vary depending on the duty factor. A current higher than the absolute maximum rating must not flow into one pin.

**Caution** P10, P12, P15, and P17 do not output high level in N-ch open-drain mode.

**Remark** Unless specified otherwise, the characteristics of alternate-function pins are the same as those of the port pins.



(T<sub>A</sub> = -40 to +85°C, 1.6 V ≤ EV<sub>DD</sub> = V<sub>DD</sub> ≤ 5.5 V, V<sub>SS</sub> = EV<sub>SS</sub> = 0 V)

(2/5)

| Items  | Symbol  | Conditions  |                                  | MIN.                            | TYP. | MAX.           | Unit  |
|--|---|---|----------------------------------|---------------------------------|------|----------------|-------|
| Output current,<br>I <sub>OL</sub> <sup>Note 1</sup> | I <sub>OL1</sub>  | Per pin for P10 to P17, P30 to P32, P40 to P43,<br>P50 to P54, P70 to P74, P120, P125 to P127, P130,<br>P140 to P147          |                                  |                                 |      | 20.0<br>Note 2 | mA    |
|  |   | Per pin for P60, P61  |                                  |                                 |      | 15.0 Note 2    | mA    |
|  |   | Total of P10 to P14, P40 to P43,<br>P120, P130, P140 to P147<br>(When duty = 70% <sup>Note 3</sup> )                          | 4.0 V ≤ EV <sub>DD</sub> ≤ 5.5 V |                                 |      | 70.0           | mA    |
|  |   |   | 2.7 V ≤ EV <sub>DD</sub> < 4.0 V |                                 |      | 15.0           | mA    |
|  |   |   | 1.8 V ≤ EV <sub>DD</sub> < 2.7 V |                                 |      | 9.0            | mA    |
|  |   |   | 1.6 V ≤ EV <sub>DD</sub> < 1.8 V |                                 |      | 4.5            | mA    |
|  |   | Total of P15 to P17, P30 to P32,<br>P50 to P54, P60, P61, P70 to P74,<br>P125 to P127<br>(When duty = 70% <sup>Note 3</sup> ) | 4.0 V ≤ EV <sub>DD</sub> ≤ 5.5 V |                                 |      | 80.0           | mA    |
|  |   |   | 2.7 V ≤ EV <sub>DD</sub> < 4.0 V |                                 |      | 35.0           | mA    |
|  |   |   | 1.8 V ≤ EV <sub>DD</sub> < 2.7 V |                                 |      | 20.0           | mA    |
|  |   |   | 1.6 V ≤ EV <sub>DD</sub> < 1.8 V |                                 |      | 10.0           | mA    |
|  | Total of all pins<br>(When duty = 70% <sup>Note 3</sup> ) |   |                                  |                                 |      |                | 150.0 |
| I <sub>OL2</sub>                                     | P20, P21  | Per pin   |                                  |                                 |      | 0.4            | mA    |
|  |   | Total of all pins   |                                  | 1.6 V ≤ V <sub>DD</sub> ≤ 5.5 V |      |                | 0.8   |

**Notes** 1. Value of current at which the device operation is guaranteed even if the current flows from the V<sub>DD</sub> and EV<sub>DD</sub> pins to an output pin.

2. Do not exceed the total current value.

3. Specification under conditions where the duty factor ≤ 70%.

The output current value that has changed to the duty factor > 70% the duty ratio can be calculated with the following expression (when changing the duty factor from 70% to n%).

- Total output current of pins = (I<sub>OH</sub> × 0.7)/(n × 0.01)

<Example> Where n = 80% and I<sub>OL</sub> = 70.0 mA

$$\text{Total output current of pins} = (70.0 \times 0.7)/(80 \times 0.01) \cong 61.25 \text{ mA}$$

However, the current that is allowed to flow into one pin does not vary depending on the duty factor. A current higher than the absolute maximum rating must not flow into one pin.

**Remark** Unless specified otherwise, the characteristics of alternate-function pins are the same as those of the port pins.

(T<sub>A</sub> = -40 to +85°C, 1.6 V ≤ EV<sub>DD</sub> = V<sub>DD</sub> ≤ 5.5 V, V<sub>SS</sub> = EV<sub>SS</sub> = 0 V)

(3/5)

| Items               | Symbol           | Conditions   | MIN.   | TYP.                | MAX. | Unit                |   |
|---------------------|------------------|--|--|---------------------|------|---------------------|---|
| Input voltage, high | V <sub>IH1</sub> | P10 to P17, P30 to P32, P40 to P43, P50 to P54, P70 to P74, P120, P125 to P127, P140 to P147 | Normal input buffer                                  | 0.8EV <sub>DD</sub> |      | EV <sub>DD</sub>    | V |
|                     | V <sub>IH2</sub> | P10, P11, P15, P16   | TTL input buffer<br>4.0 V ≤ EV <sub>DD</sub> ≤ 5.5 V | 2.2                 |      | EV <sub>DD</sub>    | V |
|                     |                  |  | TTL input buffer<br>3.3 V ≤ EV <sub>DD</sub> < 4.0 V | 2.0                 |      | EV <sub>DD</sub>    | V |
|                     |                  |  | TTL input buffer<br>1.6 V ≤ EV <sub>DD</sub> < 3.3 V | 1.50                |      | EV <sub>DD</sub>    | V |
|                     | V <sub>IH3</sub> | P20, P21   |  | 0.7V <sub>DD</sub>  |      | V <sub>DD</sub>     | V |
|                     | V <sub>IH4</sub> | P60, P61   |  | 0.7EV <sub>DD</sub> |      | EV <sub>DD</sub>    | V |
|                     | V <sub>IH5</sub> | P121 to P124, P137, EXCLK, EXCLKS, RESET   |  | 0.8V <sub>DD</sub>  |      | V <sub>DD</sub>     | V |
| Input voltage, low  | V <sub>IL1</sub> | P10 to P17, P30 to P32, P40 to P43, P50 to P54, P70 to P74, P120, P125 to P127, P140 to P147 | Normal input buffer                                  | 0                   |      | 0.2EV <sub>DD</sub> | V |
|                     | V <sub>IL2</sub> | P10, P11, P15, P16   | TTL input buffer<br>4.0 V ≤ EV <sub>DD</sub> ≤ 5.5 V | 0                   |      | 0.8                 | V |
|                     |                  |  | TTL input buffer<br>3.3 V ≤ EV <sub>DD</sub> < 4.0 V | 0                   |      | 0.5                 | V |
|                     |                  |  | TTL input buffer<br>1.6 V ≤ EV <sub>DD</sub> < 3.3 V | 0                   |      | 0.32                | V |
|                     | V <sub>IL3</sub> | P20, P21   |  | 0                   |      | 0.3V <sub>DD</sub>  | V |
|                     | V <sub>IL4</sub> | P60, P61   |  | 0                   |      | 0.3EV <sub>DD</sub> | V |
|                     | V <sub>IL5</sub> | P121 to P124, P137, EXCLK, EXCLKS, RESET   |  | 0                   |      | 0.2V <sub>DD</sub>  | V |

**Caution** The maximum value of V<sub>IH</sub> of P10, P12, P15, P17 is EV<sub>DD</sub>, even in the N-ch open-drain mode.

**Remark** Unless specified otherwise, the characteristics of alternate-function pins are the same as those of the port pins.

(T<sub>A</sub> = -40 to +85°C, 1.6 V ≤ EV<sub>DD</sub> = V<sub>DD</sub> ≤ 5.5 V, V<sub>SS</sub> = EV<sub>SS</sub> = 0 V)

(4/5)

| Items                | Symbol           | Conditions   | MIN.   | TYP.                  | MAX. | Unit |
|----------------------|------------------|--|--|-----------------------|------|------|
| Output voltage, high | V <sub>OH1</sub> | P10 to P17, P30 to P32, P40 to P43, P50 to P54, P70 to P74, P120, P125 to P127, P130, P140 to P147 | 4.0 V ≤ EV <sub>DD</sub> ≤ 5.5 V, I <sub>OH1</sub> = -10 mA  | EV <sub>DD</sub> -1.5 |      | V    |
|                      |                  |  | 4.0 V ≤ EV <sub>DD</sub> ≤ 5.5 V, I <sub>OH1</sub> = -3.0 mA | EV <sub>DD</sub> -0.7 |      | V    |
|                      |                  |  | 2.7 V ≤ EV <sub>DD</sub> ≤ 5.5 V, I <sub>OH1</sub> = -2.0 mA | EV <sub>DD</sub> -0.6 |      | V    |
|                      |                  |  | 1.8 V ≤ EV <sub>DD</sub> ≤ 5.5 V, I <sub>OH1</sub> = -1.5 mA | EV <sub>DD</sub> -0.5 |      | V    |
|                      |                  |  | 1.6 V ≤ EV <sub>DD</sub> ≤ 5.5 V, I <sub>OH1</sub> = -1.0 mA | EV <sub>DD</sub> -0.5 |      | V    |
|                      | V <sub>OH2</sub> | P20, P21   | 1.6 V ≤ V <sub>DD</sub> ≤ 5.5 V, I <sub>OH2</sub> = -100 μA  | V <sub>DD</sub> -0.5  |      | V    |
| Output voltage, low  | V <sub>OL1</sub> | P10 to P17, P30 to P32, P40 to P43, P50 to P54, P70 to P74, P120, P125 to P127, P130, P140 to P147 | 4.0 V ≤ EV <sub>DD</sub> ≤ 5.5 V, I <sub>OL1</sub> = 20 mA   |                       | 1.3  | V    |
|                      |                  |  | 4.0 V ≤ EV <sub>DD</sub> ≤ 5.5 V, I <sub>OL1</sub> = 8.5 mA  |                       | 0.7  | V    |
|                      |                  |  | 2.7 V ≤ EV <sub>DD</sub> ≤ 5.5 V, I <sub>OL1</sub> = 3.0 mA  |                       | 0.6  | V    |
|                      |                  |  | 2.7 V ≤ EV <sub>DD</sub> ≤ 5.5 V, I <sub>OL1</sub> = 1.5 mA  |                       | 0.4  | V    |
|                      |                  |  | 1.8 V ≤ EV <sub>DD</sub> ≤ 5.5 V, I <sub>OL1</sub> = 0.6 mA  |                       | 0.4  | V    |
|                      |                  |  | 1.6 V ≤ EV <sub>DD</sub> < 5.5 V, I <sub>OL1</sub> = 0.3 mA  |                       | 0.4  | V    |
|                      | V <sub>OL2</sub> | P20, P21   | 1.6 V ≤ V <sub>DD</sub> ≤ 5.5 V, I <sub>OL2</sub> = 400 μA   |                       | 0.4  | V    |
|                      | V <sub>OL3</sub> | P60, P61   | 4.0 V ≤ EV <sub>DD</sub> ≤ 5.5 V, I <sub>OL3</sub> = 15.0 mA |                       | 2.0  | V    |
|                      |                  |  | 4.0 V ≤ EV <sub>DD</sub> ≤ 5.5 V, I <sub>OL3</sub> = 5.0 mA  |                       | 0.4  | V    |
|                      |                  |  | 2.7 V ≤ EV <sub>DD</sub> ≤ 5.5 V, I <sub>OL3</sub> = 3.0 mA  |                       | 0.4  | V    |
|                      |                  |  | 1.8 V ≤ EV <sub>DD</sub> ≤ 5.5 V, I <sub>OL3</sub> = 2.0 mA  |                       | 0.4  | V    |
|                      |                  |  | 1.6 V ≤ EV <sub>DD</sub> < 5.5 V, I <sub>OL3</sub> = 1.0 mA  |                       | 0.4  | V    |

**Caution** P10, P12, P15, P17 do not output high level in N-ch open-drain mode.

**Remark** Unless specified otherwise, the characteristics of alternate-function pins are the same as those of the port pins.

(T<sub>A</sub> = -40 to +85°C, 1.6 V ≤ EV<sub>DD</sub> = V<sub>DD</sub> ≤ 5.5 V, V<sub>SS</sub> = EV<sub>SS</sub> = 0 V)

(5/5)

| Items                       | Symbol            | Conditions   | MIN.   | TYP.                                  | MAX. | Unit |     |    |
|-----------------------------|-------------------|--|--|---------------------------------------|------|------|-----|----|
| Input leakage current, high | I <sub>LIH1</sub> | P10 to P17, P30 to P32, P40 to P43, P50 to P54, P60, P61, P70 to P74, P120, P125 to P127, P140 to P147 | V <sub>I</sub> = EV <sub>DD</sub>                      |                                       |      | 1    | μA  |    |
|                             | I <sub>LIH2</sub> | P20, P21, P137, RESET  | V <sub>I</sub> = V <sub>DD</sub>                       |                                       |      | 1    | μA  |    |
|                             | I <sub>LIH3</sub> | P121 to P124 (X1, X2, XT1, XT2, EXCLK, EXCLKS)   | V <sub>I</sub> = V <sub>DD</sub>                       | In input port or external clock input |      |      | 1   | μA |
|                             |                   |  |  | In resonator connection               |      |      | 10  | μA |
| Input leakage current, low  | I <sub>LIL1</sub> | P10 to P17, P30 to P32, P40 to P43, P50 to P54, P60, P61, P70 to P74, P120, P125 to P127, P140 to P147 | V <sub>I</sub> = EV <sub>SS</sub>                      |                                       |      | -1   | μA  |    |
|                             | I <sub>LIL2</sub> | P20, P21, P137, RESET  | V <sub>I</sub> = V <sub>SS</sub>                       |                                       |      | -1   | μA  |    |
|                             | I <sub>LIL3</sub> | P121 to P124 (X1, X2, XT1, XT2, EXCLK, EXCLKS)   | V <sub>I</sub> = V <sub>SS</sub>                       | In input port or external clock input |      |      | -1  | μA |
|                             |                   |  |  | In resonator connection               |      |      | -10 | μA |
| On-chip pll-up resistance   | R <sub>U1</sub>   | V <sub>I</sub> = EV <sub>SS</sub>  | SEGxx port   |                                       |      |      |     |    |
|                             |                   |  | 2.4 V ≤ EV <sub>DD</sub> = V <sub>DD</sub> ≤ 5.5 V     |                                       | 10   | 20   | 100 | kΩ |
|                             |                   |  | 1.6 V ≤ EV <sub>DD</sub> = V <sub>DD</sub> < 2.4 V     |                                       | 10   | 30   | 100 | kΩ |
|                             | R <sub>U2</sub>   |  | Ports other than above (Except for P60, P61, and P130) |                                       | 10   | 20   | 100 | kΩ |

**Remark** Unless specified otherwise, the characteristics of alternate-function pins are the same as those of the port pins.

## 2.3.2 Supply current characteristics

(T<sub>A</sub> = -40 to +85°C, 1.6 V ≤ E<sub>VDD</sub> = V<sub>DD</sub> ≤ 5.5 V, V<sub>SS</sub> = E<sub>VSS</sub> = 0 V)

(1/3)

| Parameter                | Symbol  | Conditions       |   |   |   | MIN.                    | TYP.                    | MAX. | Unit |     |    |
|--------------------------|---|------------------|---|---|---|-------------------------|-------------------------|------|------|-----|----|
| Supply current<br>Note 1 | I <sub>DD1</sub>  | Operating mode   | HS (high-speed main) mode <sup>Note 5</sup>                             | f <sub>IH</sub> = 24 MHz <sup>Note 3</sup>                                | Basic operation   | V <sub>DD</sub> = 5.0 V |                         | 1.5  |      | mA  |    |
|                          |   |                  |   |   |   | V <sub>DD</sub> = 3.0 V |                         | 1.5  |      | mA  |    |
|                          |   |                  |   |   | Normal operation  | V <sub>DD</sub> = 5.0 V |                         | 3.3  | 5.0  | mA  |    |
|                          |   |                  |   |   | V <sub>DD</sub> = 3.0 V   |                         | 3.3                     | 5.0  | mA   |     |    |
|                          |   |                  |   |   | f <sub>IH</sub> = 16 MHz <sup>Note 3</sup>                              | Normal operation        | V <sub>DD</sub> = 5.0 V |      | 2.5  | 3.7 | mA |
|                          |   |                  |   |   |   |                         | V <sub>DD</sub> = 3.0 V |      | 2.5  | 3.7 | mA |
|                          |   |                  |   | LS (low-speed main) mode <sup>Note 5</sup>                                | f <sub>IH</sub> = 8 MHz <sup>Note 3</sup>                               | Normal operation        | V <sub>DD</sub> = 3.0 V |      | 1.2  | 1.8 | mA |
|                          |   |                  |   |   |   |                         | V <sub>DD</sub> = 2.0 V |      | 1.2  | 1.8 | mA |
|                          |   |                  |   | LV (low-voltage main) mode <sup>Note 5</sup>                              | f <sub>IH</sub> = 4 MHz <sup>Note 3</sup>                               | Normal operation        | V <sub>DD</sub> = 3.0 V |      | 1.2  | 1.7 | mA |
|                          |   |                  |   |   |   |                         | V <sub>DD</sub> = 2.0 V |      | 1.2  | 1.7 | mA |
|                          |   |                  |   | HS (high-speed main) mode <sup>Note 5</sup>                               | f <sub>MX</sub> = 20 MHz <sup>Note 2</sup> ,<br>V <sub>DD</sub> = 5.0 V | Normal operation        | Square wave input       |      | 2.8  | 4.4 | mA |
|                          |   |                  |   |   |   | Resonator connection    |                         | 3.0  | 4.6  | mA  |    |
|                          |   |                  | f <sub>MX</sub> = 20 MHz <sup>Note 2</sup> ,<br>V <sub>DD</sub> = 3.0 V |   | Normal operation  | Square wave input       |                         | 2.8  | 4.4  | mA  |    |
|                          |   |                  |   |   |   | Resonator connection    |                         | 3.0  | 4.6  | mA  |    |
|                          |   |                  | f <sub>MX</sub> = 10 MHz <sup>Note 2</sup> ,<br>V <sub>DD</sub> = 5.0 V |   | Normal operation  | Square wave input       |                         | 1.8  | 2.6  | mA  |    |
|                          |   |                  |   |   |   | Resonator connection    |                         | 1.8  | 2.6  | mA  |    |
|                          |   |                  | f <sub>MX</sub> = 10 MHz <sup>Note 2</sup> ,<br>V <sub>DD</sub> = 3.0 V |   | Normal operation  | Square wave input       |                         | 1.8  | 2.6  | mA  |    |
|                          |   |                  |   |   |   | Resonator connection    |                         | 1.8  | 2.6  | mA  |    |
|                          |   |                  | LS (low-speed main) mode <sup>Note 5</sup>                              | f <sub>MX</sub> = 8 MHz <sup>Note 2</sup> ,<br>V <sub>DD</sub> = 3.0 V    | Normal operation  | Square wave input       |                         | 1.1  | 1.7  | mA  |    |
|                          |   |                  |   |   | Resonator connection  |                         | 1.1                     | 1.7  | mA   |     |    |
|                          |   |                  |   | f <sub>MX</sub> = 8 MHz <sup>Note 2</sup> ,<br>V <sub>DD</sub> = 2.0 V    | Normal operation  | Square wave input       |                         | 1.1  | 1.7  | mA  |    |
|                          |   |                  |   |   |   | Resonator connection    |                         | 1.1  | 1.7  | mA  |    |
|                          |   |                  | Subsystem clock operation   | f <sub>SUB</sub> = 32.768 kHz <sup>Note 4</sup><br>T <sub>A</sub> = -40°C | Normal operation  | Square wave input       |                         | 3.5  | 4.9  | μA  |    |
|                          |   |                  |   |   | Resonator connection  |                         | 3.6                     | 5.0  | μA   |     |    |
|                          | f <sub>SUB</sub> = 32.768 kHz <sup>Note 4</sup><br>T <sub>A</sub> = +25°C | Normal operation |   | Square wave input   |   | 3.6                     | 4.9                     | μA   |      |     |    |
|                          |   |                  |   | Resonator connection  |   | 3.7                     | 5.0                     | μA   |      |     |    |
|                          | f <sub>SUB</sub> = 32.768 kHz <sup>Note 4</sup><br>T <sub>A</sub> = +50°C | Normal operation |   | Square wave input   |   | 3.7                     | 5.5                     | μA   |      |     |    |
|                          |   |                  |   | Resonator connection  |   | 3.8                     | 5.6                     | μA   |      |     |    |
|                          | f <sub>SUB</sub> = 32.768 kHz <sup>Note 4</sup><br>T <sub>A</sub> = +70°C | Normal operation |   | Square wave input   |   | 3.8                     | 6.3                     | μA   |      |     |    |
|                          |   |                  |   | Resonator connection  |   | 3.9                     | 6.4                     | μA   |      |     |    |
|                          | f <sub>SUB</sub> = 32.768 kHz <sup>Note 4</sup><br>T <sub>A</sub> = +85°C | Normal operation | Square wave input   |   | 4.1   | 7.7                     | μA                      |      |      |     |    |
|                          |   |                  | Resonator connection  |   | 4.2   | 7.8                     | μA                      |      |      |     |    |

(Notes and Remarks are listed on the next page.)

- Notes**
1. Total current flowing into V<sub>DD</sub> and EV<sub>DD</sub>, including the input leakage current flowing when the level of the input pin is fixed to V<sub>DD</sub>, EV<sub>DD</sub> or V<sub>SS</sub>, EV<sub>SS</sub>. The values below the MAX. column include the peripheral operation current. However, not including the current flowing into the A/D converter, LVD circuit, I/O port, and on-chip pull-up/pull-down resistors and the current flowing during data flash rewrite.
  2. When high-speed on-chip oscillator and subsystem clock are stopped.
  3. When high-speed system clock and subsystem clock are stopped.
  4. When high-speed on-chip oscillator and high-speed system clock are stopped. When AMPHS1 = 1 (Ultra-low power consumption oscillation). However, not including the current flowing into the RTC, 12-bit interval timer, watchdog timer, and LCD controller/driver.
  5. Relationship between operation voltage width, operation frequency of CPU and operation mode is as below.
    - HS (high-speed main) mode: 2.7 V ≤ V<sub>DD</sub> ≤ 5.5 V@1 MHz to 24 MHz  
2.4 V ≤ V<sub>DD</sub> ≤ 5.5 V@1 MHz to 16 MHz
    - LS (low-speed main) mode: 1.8 V ≤ V<sub>DD</sub> ≤ 5.5 V@1 MHz to 8 MHz
    - LV (low-voltage main) mode: 1.6 V ≤ V<sub>DD</sub> ≤ 5.5 V@1 MHz to 4 MHz

- Remarks**
1. f<sub>MX</sub>: High-speed system clock frequency (X1 clock oscillation frequency or external main system clock frequency)
  2. f<sub>IH</sub>: High-speed on-chip oscillator clock frequency
  3. f<sub>SUB</sub>: Subsystem clock frequency (XT1 clock oscillation frequency)
  4. Except subsystem clock operation, temperature condition of the TYP. value is T<sub>A</sub> = 25°C

(T<sub>A</sub> = -40 to +85°C, 1.6 V ≤ EV<sub>DD</sub> = V<sub>DD</sub> ≤ 5.5 V, V<sub>SS</sub> = EV<sub>SS</sub> = 0 V)

(2/3)

| Parameter                | Symbol   | Conditions           |   |  | MIN.  | TYP.                    | MAX. | Unit |    |
|--------------------------|--|----------------------|---|--|---|-------------------------|------|------|----|
| Supply current<br>Note 1 | I <sub>DD2</sub><br>Note 2                                     | HALT mode            | HS (high-speed main) mode Note 7                            | f <sub>IH</sub> = 24 MHz Note 4                                | V <sub>DD</sub> = 5.0 V                                     | 0.44                    | 1.28 | mA   |    |
|                          |  |                      |   |  | V <sub>DD</sub> = 3.0 V                                     | 0.44                    | 1.28 | mA   |    |
|                          |  |                      |   | f <sub>IH</sub> = 16 MHz Note 4                                | V <sub>DD</sub> = 5.0 V                                     | 0.40                    | 1.00 | mA   |    |
|                          |  |                      |   |  | V <sub>DD</sub> = 3.0 V                                     | 0.40                    | 1.00 | mA   |    |
|                          |  |                      |   | LS (low-speed main) mode Note 7                                | f <sub>IH</sub> = 8 MHz Note 4                              | V <sub>DD</sub> = 3.0 V | 260  | 530  | μA |
|                          |  |                      |   |  | V <sub>DD</sub> = 2.0 V                                     | 260                     | 530  | μA   |    |
|                          |  |                      |   | LV (low-voltage main) mode Note 7                              | f <sub>IH</sub> = 4 MHz Note 4                              | V <sub>DD</sub> = 3.0 V | 420  | 640  | μA |
|                          |  |                      |   |  | V <sub>DD</sub> = 2.0 V                                     | 420                     | 640  | μA   |    |
|                          |  |                      |   | HS (high-speed main) mode Note 7                               | f <sub>MX</sub> = 20 MHz Note 3,<br>V <sub>DD</sub> = 5.0 V | Square wave input       | 0.28 | 1.00 | mA |
|                          |  |                      |   |  |   | Resonator connection    | 0.45 | 1.17 | mA |
|                          |  |                      |   |  | f <sub>MX</sub> = 20 MHz Note 3,<br>V <sub>DD</sub> = 3.0 V | Square wave input       | 0.28 | 1.00 | mA |
|                          |  |                      |   |  |   | Resonator connection    | 0.45 | 1.17 | mA |
|                          |  |                      |   |  | f <sub>MX</sub> = 10 MHz Note 3,<br>V <sub>DD</sub> = 5.0 V | Square wave input       | 0.19 | 0.60 | mA |
|                          |  |                      |   |  |   | Resonator connection    | 0.26 | 0.67 | mA |
|                          |  |                      | f <sub>MX</sub> = 10 MHz Note 3,<br>V <sub>DD</sub> = 3.0 V |  | Square wave input   | 0.19                    | 0.60 | mA   |    |
|                          |  |                      |   |  | Resonator connection  | 0.26                    | 0.67 | mA   |    |
|                          |  |                      | LS (low-speed main) mode Note 7                             | f <sub>MX</sub> = 8 MHz Note 3,<br>V <sub>DD</sub> = 3.0 V     | Square wave input   | 95                      | 330  | μA   |    |
|                          |  |                      |   |  | Resonator connection  | 145                     | 380  | μA   |    |
|                          |  |                      |   | f <sub>MX</sub> = 8 MHz Note 3,<br>V <sub>DD</sub> = 2.0 V     | Square wave input   | 95                      | 330  | μA   |    |
|                          |  |                      |   |  | Resonator connection  | 145                     | 380  | μA   |    |
|                          |  |                      | Subsystem clock operation                                   | f <sub>SUB</sub> = 32.768 kHz Note 5<br>T <sub>A</sub> = -40°C | Square wave input   | 0.31                    | 0.57 | μA   |    |
|                          |  |                      |   |  | Resonator connection  | 0.50                    | 0.76 | μA   |    |
|                          |  |                      |   | f <sub>SUB</sub> = 32.768 kHz Note 5<br>T <sub>A</sub> = +25°C | Square wave input   | 0.37                    | 0.57 | μA   |    |
|                          | Resonator connection   | 0.56                 |   |  | 0.76  | μA                      |      |      |    |
|                          | f <sub>SUB</sub> = 32.768 kHz Note 5<br>T <sub>A</sub> = +50°C | Square wave input    |   | 0.46   | 1.17  | μA                      |      |      |    |
|                          |  | Resonator connection |   | 0.65   | 1.36  | μA                      |      |      |    |
|                          | f <sub>SUB</sub> = 32.768 kHz Note 5<br>T <sub>A</sub> = +70°C | Square wave input    |   | 0.57   | 1.97  | μA                      |      |      |    |
|                          |  | Resonator connection |   | 0.76   | 2.16  | μA                      |      |      |    |
|                          | f <sub>SUB</sub> = 32.768 kHz Note 5<br>T <sub>A</sub> = +85°C | Square wave input    | 0.85  | 3.37   | μA  |                         |      |      |    |
|                          |  | Resonator connection | 1.04  | 3.56   | μA  |                         |      |      |    |
|                          | I <sub>DD3</sub> Note 6  | STOP mode Note 8     | T <sub>A</sub> = -40°C                                      |  | 0.17  | 0.50                    | μA   |      |    |
|                          |  |                      | T <sub>A</sub> = +25°C                                      |  | 0.23  | 0.50                    | μA   |      |    |
|                          |  |                      | T <sub>A</sub> = +50°C                                      |  | 0.32  | 1.10                    | μA   |      |    |
|                          |  |                      | T <sub>A</sub> = +70°C                                      |  | 0.43  | 1.90                    | μA   |      |    |
|                          |  |                      | T <sub>A</sub> = +85°C                                      |  | 0.71  | 3.30                    | μA   |      |    |

(Notes and Remarks are listed on the next page.)

- Notes**
1. Total current flowing into V<sub>DD</sub> and EV<sub>DD</sub>, including the input leakage current flowing when the level of the input pin is fixed to V<sub>DD</sub>, EV<sub>DD</sub> or V<sub>SS</sub>, EV<sub>SS</sub>. The values below the MAX. column include the peripheral operation current. However, not including the current flowing into the A/D converter, LVD circuit, I/O port, and on-chip pull-up/pull-down resistors and the current flowing during data flash rewrite.
  2. During HALT instruction execution by flash memory.
  3. When high-speed on-chip oscillator and subsystem clock are stopped.
  4. When high-speed system clock and subsystem clock are stopped.
  5. When high-speed on-chip oscillator and high-speed system clock are stopped. When RTCLPC = 1 and setting ultra-low current consumption (AMPHS1 = 1). The current flowing into the RTC is included. However, not including the current flowing into the 12-bit interval timer, watchdog timer, and LCD controller/driver.
  6. Not including the current flowing into the RTC, 12-bit interval timer, and watchdog timer.
  7. Relationship between operation voltage width, operation frequency of CPU and operation mode is as below.
    - HS (high-speed main) mode:  $2.7\text{ V} \leq V_{DD} \leq 5.5\text{ V}@1\text{ MHz to }24\text{ MHz}$   
 $2.4\text{ V} \leq V_{DD} \leq 5.5\text{ V}@1\text{ MHz to }16\text{ MHz}$
    - LS (low-speed main) mode:  $1.8\text{ V} \leq V_{DD} \leq 5.5\text{ V}@1\text{ MHz to }8\text{ MHz}$
    - LV (low-voltage main) mode:  $1.6\text{ V} \leq V_{DD} \leq 5.5\text{ V}@1\text{ MHz to }4\text{ MHz}$
  8. Regarding the value for current to operate the subsystem clock in STOP mode, refer to that in HALT mode.

- Remarks**
1. f<sub>MX</sub>: High-speed system clock frequency (X1 clock oscillation frequency or external main system clock frequency)
  2. f<sub>IH</sub>: High-speed on-chip oscillator clock frequency
  3. f<sub>SUB</sub>: Subsystem clock frequency (XT1 clock oscillation frequency)
  4. Except subsystem clock operation and STOP mode, temperature condition of the TYP. value is T<sub>A</sub> = 25°C



(T<sub>A</sub> = -40 to +85°C, 1.6 V ≤ EV<sub>DD</sub> = V<sub>DD</sub> ≤ 5.5 V, V<sub>SS</sub> = EV<sub>SS</sub> = 0 V)

(3/3)

| Parameter                                      | Symbol   | Conditions                           |   | MIN.   | TYP. | MAX.  | Unit |
|--|--|--------------------------------------|---|--|------|-------|------|
| Low-speed on-chip oscillator operating current | I <sub>FIL</sub> <sup>Note 1</sup>   |                                      |   |  | 0.20 |       | μA   |
| RTC operating current                          | I <sub>RTC</sub><br><sup>Notes 1, 2, 3</sup>                                       | f <sub>MAIN</sub> is stopped         |   |  | 0.08 |       | μA   |
| 12-bit interval timer current                  | I <sub>IT</sub><br><sup>Notes 1, 2, 4</sup>  |                                      |   |  | 0.08 |       | μA   |
| Watchdog timer operating current               | I <sub>WDT</sub><br><sup>Notes 1, 2, 5</sup>                                       | f <sub>IL</sub> = 15 kHz             |   |  | 0.24 |       | μA   |
| A/D converter operating current                | I <sub>ADC</sub><br><sup>Notes 1, 6</sup>  | When conversion at maximum speed     | Normal mode, AV <sub>REFP</sub> = V <sub>DD</sub> = 5.0 V   |  | 1.3  | 1.7   | mA   |
|  |  |                                      | Low voltage mode, AV <sub>REFP</sub> = V <sub>DD</sub> = 3.0 V  |  | 0.5  | 0.7   | mA   |
| A/D converter reference voltage current        | I <sub>ADREF</sub> <sup>Note 1</sup>   |                                      |   |  | 75.0 |       | μA   |
| Temperature sensor operating current           | I <sub>TMPS</sub> <sup>Note 1</sup>  |                                      |   |  | 75.0 |       | μA   |
| LVD operating current                          | I <sub>LVD</sub><br><sup>Notes 1, 7</sup>  |                                      |   |  | 0.08 |       | μA   |
| Self-programming operating current             | I <sub>FSP</sub><br><sup>Notes 1, 9</sup>  |                                      |   |  | 2.50 | 12.20 | mA   |
| BGO operating current                          | I <sub>BGO</sub><br><sup>Notes 1, 8</sup>  |                                      |   |  | 2.00 | 12.20 | mA   |
| LCD operating current                          | I <sub>LCD1</sub><br><sup>Notes 11, 12</sup>                                       | External resistance division method  | V <sub>DD</sub> = EV <sub>DD</sub> = 5.0 V<br>V <sub>L4</sub> = 5.0 V                                       |  | 0.04 | 0.20  | μA   |
|  |  | I <sub>LCD2</sub> <sup>Note 11</sup> | Internal voltage boosting method  | V <sub>DD</sub> = EV <sub>DD</sub> = 5.0 V<br>V <sub>L4</sub> = 5.1 V (VLCD = 12H) |      | 1.12  | 3.70 |
|  | V <sub>DD</sub> = EV <sub>DD</sub> = 3.0 V<br>V <sub>L4</sub> = 3.0 V (VLCD = 04H) |                                      |   |  | 0.63 | 2.20  | μA   |
|  | I <sub>LCD3</sub> <sup>Note 11</sup>   | Capacitor split method               | V <sub>DD</sub> = EV <sub>DD</sub> = 3.0 V<br>V <sub>L4</sub> = 3.0 V                                       |  | 0.12 | 0.50  | μA   |
| SNOOZE operating current                       | I <sub>SNOZ</sub> <sup>Note 1</sup>  | ADC operation                        | The mode is performed <sup>Note 10</sup>  |  | 0.50 | 0.60  | mA   |
|  |  |                                      | The A/D conversion operations are performed, Low voltage mode, AV <sub>REFP</sub> = V <sub>DD</sub> = 3.0 V |  | 1.20 | 1.44  | mA   |
|  |  | CSI/UART operation                   |   | 0.70   | 0.84 | mA    |      |

(Notes and Remarks are listed on the next page.)

- Notes**
1. Current flowing to V<sub>DD</sub>.
  2. When high speed on-chip oscillator and high-speed system clock are stopped.
  3. Current flowing only to the real-time clock (RTC) (excluding the operating current of the low-speed on-chip oscillator and the XT1 oscillator). The supply current of the RL78 microcontrollers is the sum of the values of either I<sub>DD1</sub> or I<sub>DD2</sub>, and I<sub>RTC</sub>, when the real-time clock operates in operation mode or HALT mode. When the low-speed on-chip oscillator is selected, I<sub>FIL</sub> should be added. I<sub>DD2</sub> subsystem clock operation includes the operational current of the real-time clock.
  4. Current flowing only to the 12-bit interval timer (excluding the operating current of the low-speed on-chip oscillator and the XT1 oscillator). The supply current of the RL78 microcontrollers is the sum of the values of either I<sub>DD1</sub> or I<sub>DD2</sub>, and I<sub>IT</sub>, when the 12-bit interval timer operates in operation mode or HALT mode. When the low-speed on-chip oscillator is selected, I<sub>FIL</sub> should be added.
  5. Current flowing only to the watchdog timer (including the operating current of the low-speed on-chip oscillator). The supply current of the RL78 microcontrollers is the sum of I<sub>DD1</sub>, I<sub>DD2</sub> or I<sub>DD3</sub> and I<sub>WDT</sub> when the watchdog timer is in operation.
  6. Current flowing only to the A/D converter. The supply current of the RL78 microcontrollers is the sum of I<sub>DD1</sub> or I<sub>DD2</sub> and I<sub>ADC</sub> when the A/D converter operates in an operation mode or the HALT mode.
  7. Current flowing only to the LVD circuit. The supply current of the RL78 microcontrollers is the sum of I<sub>DD1</sub>, I<sub>DD2</sub> or I<sub>DD3</sub> and I<sub>LVD</sub> when the LVD circuit is in operation.
  8. Current flowing only during data flash rewrite.
  9. Current flowing only during self programming.
  10. For shift time to the SNOOZE mod.
  11. Current flowing only to the LCD controller/driver. The supply current value of the RL78 microcontrollers is the sum of the LCD operating current (I<sub>LCD1</sub>, I<sub>LCD2</sub> or I<sub>LCD3</sub>) to the supply current (I<sub>DD1</sub> or I<sub>DD2</sub>) when the LCD controller/driver operates in an operation mode or HALT mode. Not including the current that flows through the LCD panel.  
The TYP. value and MAX. value are following conditions.
    - When f<sub>SUB</sub> is selected for system clock, LCD clock = 128 Hz (LCDC0 = 07H)
    - 4-Time-Slice, 1/3 Bias Method
  12. Not including the current that flows through the external divider resistor when the external resistance division method is used.

- Remarks**
1. f<sub>FIL</sub>: Low-speed on-chip oscillator clock frequency
  2. f<sub>SUB</sub>: Subsystem clock frequency (XT1 clock oscillation frequency)
  3. f<sub>CLK</sub>: CPU/peripheral hardware clock frequency
  4. Temperature condition of the TYP. value is T<sub>A</sub> = 25°C

## 2.4 AC Characteristics

## 2.4.1 Basic operation

(T<sub>A</sub> = -40 to +85°C, 1.6 V ≤ EV<sub>DD</sub> = V<sub>DD</sub> ≤ 5.5 V, V<sub>SS</sub> = EV<sub>SS</sub> = 0 V)

| Items  | Symbol                                | Conditions                                       |                                  | MIN.                            | TYP.                            | MAX.  | Unit |    |
|--|---------------------------------------|--|----------------------------------|---------------------------------|---------------------------------|-------|------|----|
| Instruction cycle (minimum instruction execution time)             | T <sub>cy</sub>                       | Main system clock (f <sub>MAIN</sub> ) operation | HS (high-speed main) mode        | 2.7 V ≤ V <sub>DD</sub> ≤ 5.5 V | 0.04167                         | 1     | μs   |    |
|  |                                       |  |                                  | 2.4 V ≤ V <sub>DD</sub> < 2.7 V | 0.0625                          | 1     | μs   |    |
|  |                                       |  | LV (low voltage main) mode       | 1.6 V ≤ V <sub>DD</sub> ≤ 5.5 V | 0.25                            | 1     | μs   |    |
|  |                                       |  |                                  | LS (low-speed main) mode        | 1.8 V ≤ V <sub>DD</sub> ≤ 5.5 V | 0.125 | 1    | μs |
|  |                                       | Subsystem clock (f <sub>SUB</sub> ) operation    |                                  | 1.8 V ≤ V <sub>DD</sub> ≤ 5.5 V | 28.5                            | 30.5  | 31.3 | μs |
|  |                                       | In the self programming mode                     | HS (high-speed main) mode        | 2.7 V ≤ V <sub>DD</sub> ≤ 5.5 V | 0.04167                         | 1     | μs   |    |
|  |                                       |  |                                  | 2.4 V ≤ V <sub>DD</sub> < 2.7 V | 0.0625                          | 1     | μs   |    |
|  |                                       |  | LV (low voltage main) mode       | 1.8 V ≤ V <sub>DD</sub> ≤ 5.5 V | 0.25                            | 1     | μs   |    |
| LS (low-speed main) mode   | 1.8 V ≤ V <sub>DD</sub> ≤ 5.5 V       |  |                                  | 0.125                           | 1                               | μs    |      |    |
| External main system clock frequency                               | f <sub>EX</sub>                       | 2.7 V ≤ V <sub>DD</sub> ≤ 5.5 V                  |                                  | 1.0                             |                                 | 20.0  | MHz  |    |
|  |                                       | 2.4 V ≤ V <sub>DD</sub> < 2.7 V                  |                                  | 1.0                             |                                 | 16.0  | MHz  |    |
|  |                                       | 1.8 V ≤ V <sub>DD</sub> < 2.4 V                  |                                  | 1.0                             |                                 | 8.0   | MHz  |    |
|  |                                       | 1.6 V ≤ V <sub>DD</sub> < 1.8 V                  |                                  | 1.0                             |                                 | 4.0   | MHz  |    |
|  | f <sub>EXS</sub>                      |  |                                  | 32                              |                                 | 35    | kHz  |    |
| External main system clock input high-level width, low-level width | t <sub>EXH</sub> , t <sub>EXL</sub>   | 2.7 V ≤ V <sub>DD</sub> ≤ 5.5 V                  |                                  | 24                              |                                 |       | ns   |    |
|  |                                       | 2.4 V ≤ V <sub>DD</sub> < 2.7 V                  |                                  | 30                              |                                 |       | ns   |    |
|  |                                       | 1.8 V ≤ V <sub>DD</sub> < 2.4 V                  |                                  | 60                              |                                 |       | ns   |    |
|  |                                       | 1.6 V ≤ V <sub>DD</sub> < 1.8 V                  |                                  | 120                             |                                 |       | ns   |    |
|  | t <sub>EXHS</sub> , t <sub>EXLS</sub> |  |                                  | 13.7                            |                                 |       | μs   |    |
| TI00 to TI07 input high-level width, low-level width               | t <sub>TIH</sub> , t <sub>TIL</sub>   |  |                                  | 1/f <sub>MCK</sub> +10          |                                 |       | ns   |    |
| TO00 to TO07 output frequency                                      | f <sub>TO</sub>                       | HS (high-speed main) mode                        | 4.0 V ≤ EV <sub>DD</sub> ≤ 5.5 V |                                 |                                 | 16    | MHz  |    |
|  |                                       |  | 2.7 V ≤ EV <sub>DD</sub> < 4.0 V |                                 |                                 | 8     | MHz  |    |
|  |                                       |  | 2.4 V ≤ EV <sub>DD</sub> < 2.7 V |                                 |                                 | 4     | MHz  |    |
|  |                                       | LS (low-speed main) mode                         | 1.8 V ≤ EV <sub>DD</sub> ≤ 5.5 V |                                 |                                 | 4     | MHz  |    |
|  |                                       | LV (low voltage main) mode                       | 1.6 V ≤ EV <sub>DD</sub> ≤ 5.5 V |                                 |                                 | 2     | MHz  |    |
| PCLBUZ0, PCLBUZ1 output frequency                                  | f <sub>PCL</sub>                      | HS (high-speed main) mode                        | 4.0 V ≤ EV <sub>DD</sub> ≤ 5.5 V |                                 |                                 | 16    | MHz  |    |
|  |                                       |  | 2.7 V ≤ EV <sub>DD</sub> < 4.0 V |                                 |                                 | 8     | MHz  |    |
|  |                                       |  | 2.4 V ≤ EV <sub>DD</sub> < 2.7 V |                                 |                                 | 4     | MHz  |    |
|  |                                       | LS (low-speed main) mode                         | 1.8 V ≤ EV <sub>DD</sub> ≤ 5.5 V |                                 |                                 | 4     | MHz  |    |
|  |                                       | LV (low-voltage main) mode                       | 1.8 V ≤ EV <sub>DD</sub> ≤ 5.5 V |                                 |                                 | 4     | MHz  |    |
| 1.6 V ≤ EV <sub>DD</sub> < 1.8 V                                   |                                       |  | 2                                | MHz                             |                                 |       |      |    |
| Interrupt input high-level width, low-level width                  | t <sub>INTH</sub> , t <sub>INTL</sub> | INTP0  | 1.6 V ≤ V <sub>DD</sub> ≤ 5.5 V  | 1                               |                                 |       | μs   |    |
|  |                                       | INTP1 to INTP7                                   | 1.6 V ≤ EV <sub>DD</sub> ≤ 5.5 V | 1                               |                                 |       | μs   |    |
| Key interrupt input low-level width                                | t <sub>KR</sub>                       | KR0 to KR3                                       | 1.8 V ≤ EV <sub>DD</sub> ≤ 5.5 V | 250                             |                                 |       | ns   |    |
|  |                                       |  | 1.6 V ≤ EV <sub>DD</sub> < 1.8 V | 1                               |                                 |       | μs   |    |
| RESET low-level width  | t <sub>RSL</sub>                      |  |                                  | 10                              |                                 |       | μs   |    |

**Remark** f<sub>MCK</sub>: Timer array unit operation clock frequency

(Operation clock to be set by the CKS0n bit of timer mode register 0n (TMR0n). n: Channel number (n = 0 to 7))

**Minimum Instruction Execution Time during Main System Clock Operation**

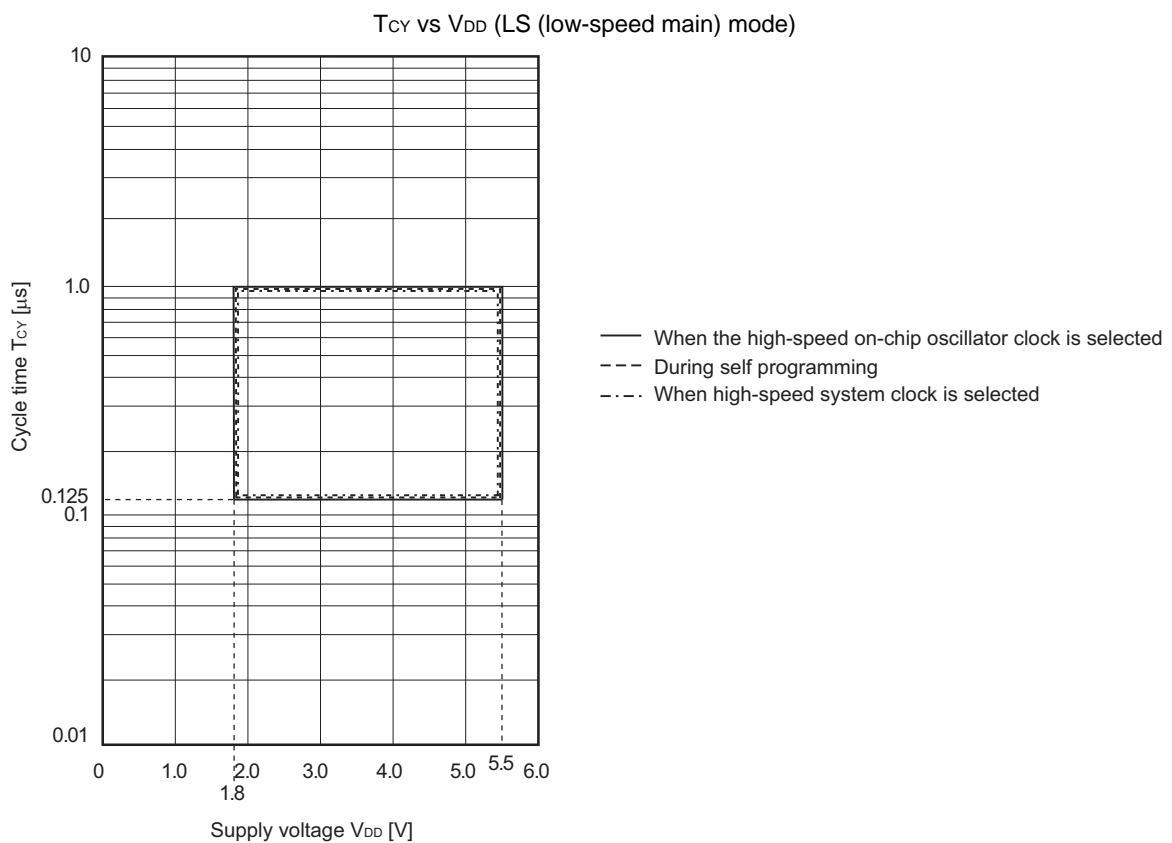
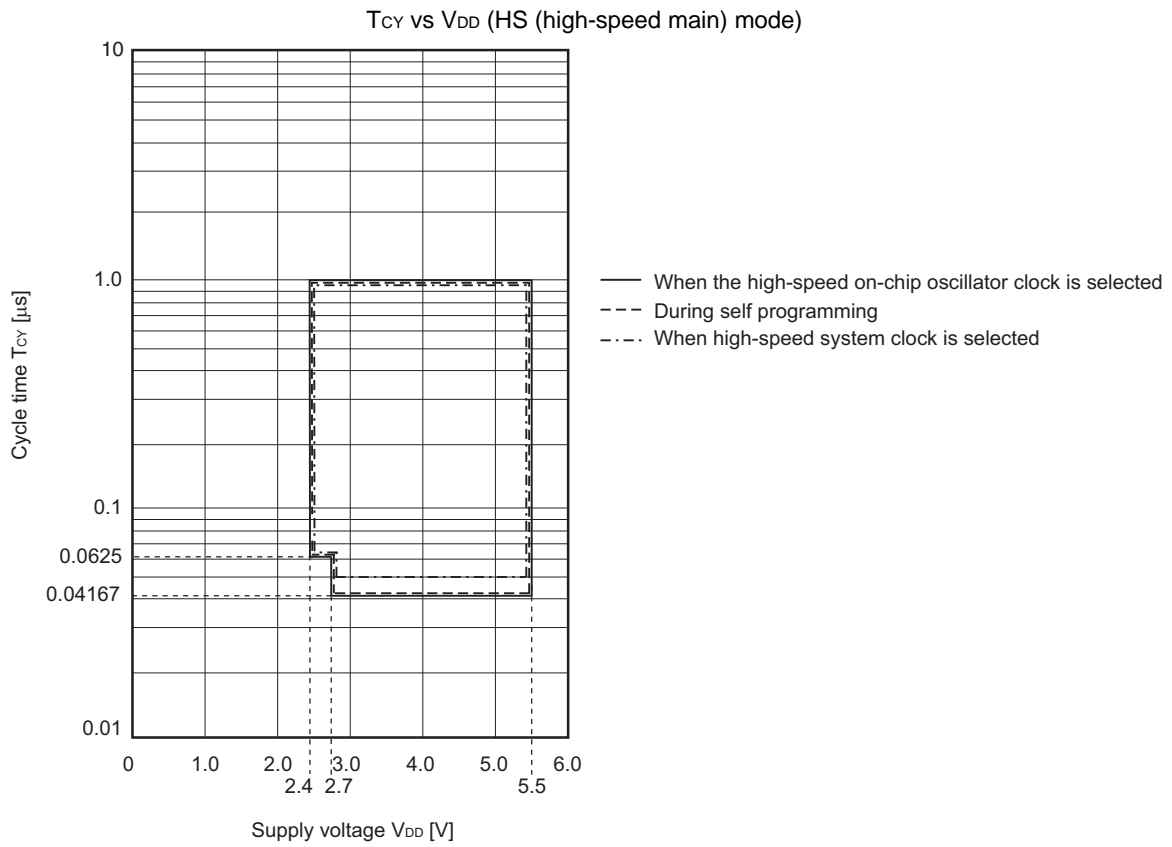

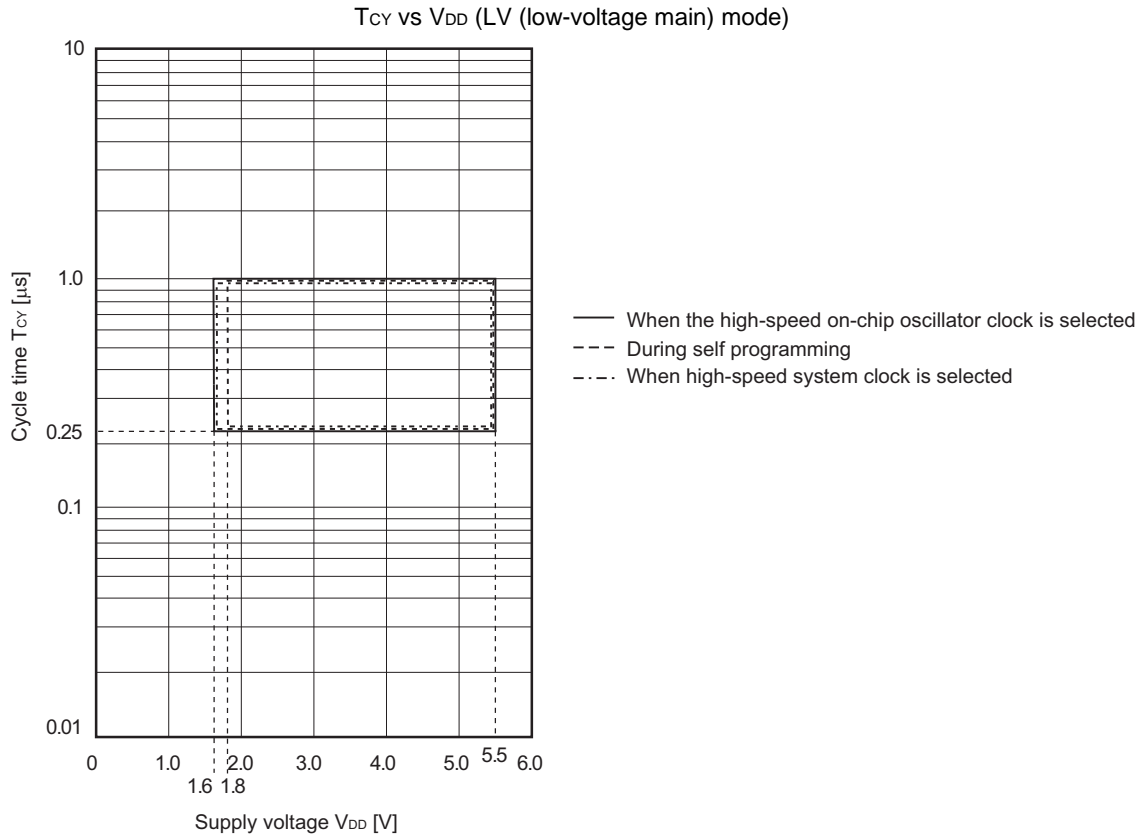

**AC Timing Test Points**



**External System Clock Timing**

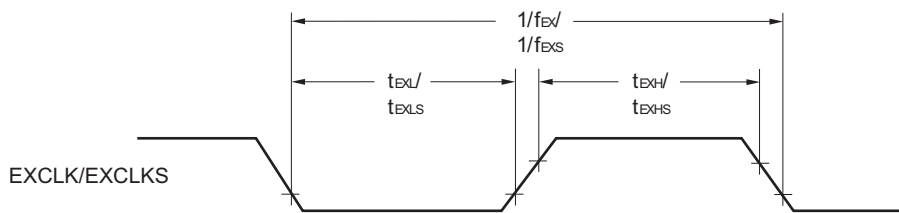

**TI/TO Timing**

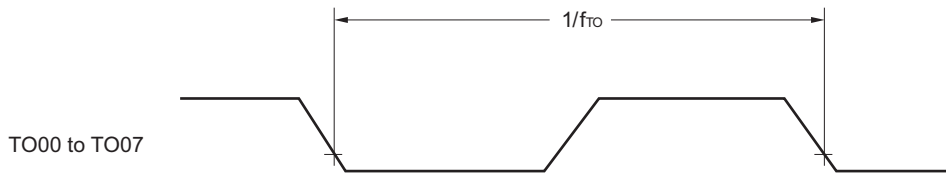
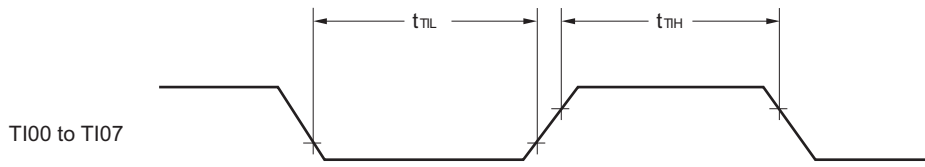

**Interrupt Request Input Timing**

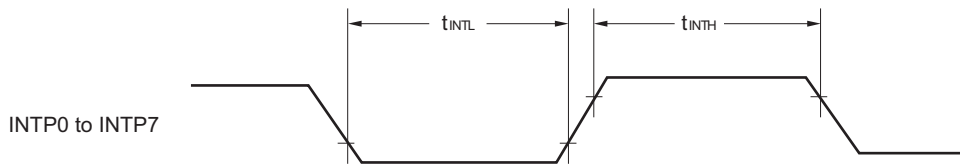

**Key Interrupt Input Timing**

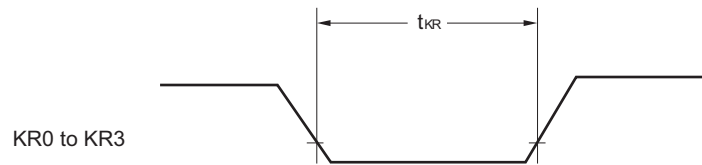

**RESET Input Timing**

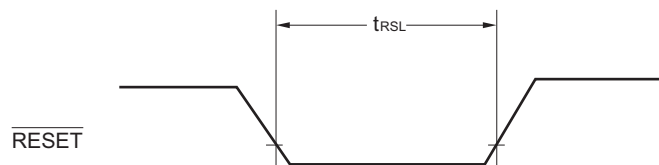

## 2.5 Peripheral Functions Characteristics

### AC Timing Test Points

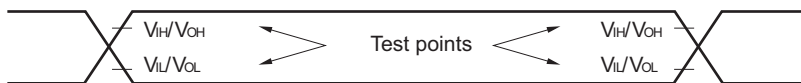

### 2.5.1 Serial array unit

#### (1) During communication at same potential (UART mode)

(T<sub>A</sub> = -40 to +85°C, 1.6 V ≤ EV<sub>DD</sub> = V<sub>DD</sub> ≤ 5.5 V, V<sub>SS</sub> = EV<sub>SS</sub> = 0 V)

| Parameter                       | Symbol | Conditions  | HS (high-speed main) Mode |                     | LS (low-speed main) Mode |                     | LV (low-voltage main) Mode |                     | Unit |
|---------------------------------|--------|---|---------------------------|---------------------|--------------------------|---------------------|----------------------------|---------------------|------|
|                                 |        |   | MIN.                      | MAX.                | MIN.                     | MAX.                | MIN.                       | MAX.                |      |
| Transfer rate <sup>Note 1</sup> |        | 2.4 V ≤ EV <sub>DD</sub> = V <sub>DD</sub> ≤ 5.5 V  |                           | f <sub>MCK</sub> /6 |                          | f <sub>MCK</sub> /6 |                            | f <sub>MCK</sub> /6 | bps  |
|                                 |        | Theoretical value of the maximum transfer rate<br>f <sub>MCK</sub> = f <sub>CLK</sub> <sup>Note 2</sup> |                           | 4.0                 |                          | 1.3                 |                            | 0.6                 | Mbps |
|                                 |        | 1.8 V ≤ EV <sub>DD</sub> = V <sub>DD</sub> ≤ 5.5 V  |                           |                     |                          | f <sub>MCK</sub> /6 |                            | f <sub>MCK</sub> /6 | bps  |
|                                 |        | Theoretical value of the maximum transfer rate<br>f <sub>MCK</sub> = f <sub>CLK</sub> <sup>Note 2</sup> |                           |                     |                          | 1.3                 |                            | 0.6                 | Mbps |
|                                 |        | 1.6 V ≤ EV <sub>DD</sub> = V <sub>DD</sub> ≤ 5.5 V  |                           |                     |                          |                     |                            | f <sub>MCK</sub> /6 | bps  |
|                                 |        | Theoretical value of the maximum transfer rate<br>f <sub>MCK</sub> = f <sub>CLK</sub> <sup>Note 2</sup> |                           |                     |                          |                     |                            | 0.6                 | Mbps |

**Notes 1.** Transfer rate in the SNOOZE mode is 4800 bps only.

**2.** The maximum operating frequencies of the CPU/peripheral hardware clock (f<sub>CLK</sub>) are:

HS (high-speed main) mode: 24 MHz (2.7 V ≤ V<sub>DD</sub> ≤ 5.5 V)

16 MHz (2.4 V ≤ V<sub>DD</sub> ≤ 5.5 V)

LS (low-speed main) mode: 8 MHz (1.8 V ≤ V<sub>DD</sub> ≤ 5.5 V)

LV (low-voltage main) mode: 4 MHz (1.6 V ≤ V<sub>DD</sub> ≤ 5.5 V)

**Caution** Select the normal input buffer for the RxDq pin and the normal output mode for the TxDq pin by using port input mode register g (PIMg) and port output mode register g (POMg).

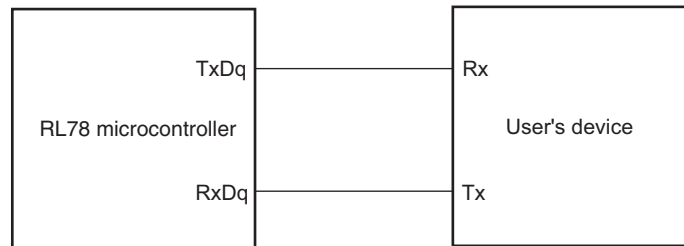
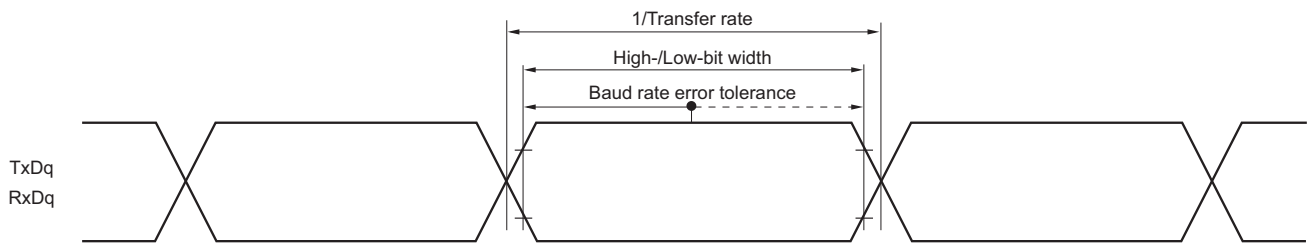
**UART mode connection diagram (during communication at same potential)****UART mode bit width (during communication at same potential) (reference)**

- Remarks**
1. q: UART number (q = 0), g: PIM and POM number (g = 1)
  2.  $f_{\text{MCK}}$ : Serial array unit operation clock frequency  
(Operation clock to be set by the serial clock select register m (SPSm) and the CKSmn bit of serial mode register mn (SMRmn). m: Unit number, n: Channel number (mn = 00, 01))



(2) During communication at same potential (CSI mode) (master mode, SCKp... internal clock output)  
(T<sub>A</sub> = -40 to +85°C, 1.6 V ≤ EV<sub>DD</sub> = V<sub>DD</sub> ≤ 5.5 V, V<sub>SS</sub> = EV<sub>SS</sub> = 0 V)

| Parameter                                     | Symbol                                 | Conditions                       | HS (high-speed main) Mode        |      | LS (low-speed main) Mode     |      | LV (low-voltage main) Mode    |      | Unit |
|---|--|----------------------------------|----------------------------------|------|------------------------------|------|-------------------------------|------|------|
|   |  |                                  | MIN.                             | MAX. | MIN.                         | MAX. | MIN.                          | MAX. |      |
| SCKp cycle time                               | t <sub>KCY1</sub>                      | 2.7 V ≤ EV <sub>DD</sub> ≤ 5.5 V | 167<br>Note 1                    |      | 500<br>Note 1                |      | 1000<br>Note 1                |      | ns   |
|   |  | 2.4 V ≤ EV <sub>DD</sub> ≤ 5.5 V | 250<br>Note 1                    |      | 500<br>Note 1                |      | 1000<br>Note 1                |      | ns   |
|   |  | 1.8 V ≤ EV <sub>DD</sub> ≤ 5.5 V |                                  |      | 500<br>Note 1                |      | 1000<br>Note 1                |      | ns   |
|   |  | 1.6 V ≤ EV <sub>DD</sub> ≤ 5.5 V |                                  |      |                              |      | 1000<br>Note 1                |      | ns   |
| SCKp high-/low-level width                    | t <sub>KH1</sub> ,<br>t <sub>KL1</sub> | 4.0 V ≤ EV <sub>DD</sub> ≤ 5.5 V | t <sub>KCY1</sub> /2<br>- 12     |      | t <sub>KCY1</sub> /2<br>- 50 |      | t <sub>KCY1</sub> /2<br>- 50  |      | ns   |
|   |  | 2.7 V ≤ EV <sub>DD</sub> ≤ 5.5 V | t <sub>KCY1</sub> /2<br>- 18     |      | t <sub>KCY1</sub> /2<br>- 50 |      | t <sub>KCY1</sub> /2<br>- 50  |      | ns   |
|   |  | 2.4 V ≤ EV <sub>DD</sub> ≤ 5.5 V | t <sub>KCY1</sub> /2<br>- 38     |      | t <sub>KCY1</sub> /2<br>- 50 |      | t <sub>KCY1</sub> /2<br>- 50  |      | ns   |
|   |  | 1.8 V ≤ EV <sub>DD</sub> ≤ 5.5 V |                                  |      | t <sub>KCY1</sub> /2<br>- 50 |      | t <sub>KCY1</sub> /2<br>- 50  |      | ns   |
|   |  | 1.6 V ≤ EV <sub>DD</sub> ≤ 5.5 V |                                  |      |                              |      | t <sub>KCY1</sub> /2<br>- 100 |      | ns   |
| Slp setup time (to SCKp↑)<br>Note 2           | t <sub>SIK1</sub>                      | 2.7 V ≤ EV <sub>DD</sub> ≤ 5.5 V | 44                               |      | 110                          |      | 110                           |      | ns   |
|   |  | 2.4 V ≤ EV <sub>DD</sub> ≤ 5.5 V | 75                               |      | 110                          |      | 110                           |      | ns   |
|   |  | 1.8 V ≤ EV <sub>DD</sub> ≤ 5.5 V |                                  |      | 110                          |      | 110                           |      | ns   |
|   |  | 1.6 V ≤ EV <sub>DD</sub> ≤ 5.5 V |                                  |      |                              |      | 220                           |      | ns   |
| Slp hold time (from SCKp↑)<br>Note 3          | t <sub>KSH1</sub>                      | 2.4 V ≤ EV <sub>DD</sub> ≤ 5.5 V | 19                               |      | 19                           |      | 19                            |      | ns   |
|   |  | 1.8 V ≤ EV <sub>DD</sub> ≤ 5.5 V |                                  |      | 19                           |      | 19                            |      |      |
|   |  | 1.6 V ≤ EV <sub>DD</sub> ≤ 5.5 V |                                  |      |                              |      | 19                            |      |      |
| Delay time from SCKp↓ to SOP output<br>Note 4 | t <sub>KSO1</sub>                      | C = 30 pF<br>Note 5              | 2.4 V ≤ EV <sub>DD</sub> ≤ 5.5 V |      | 25                           |      | 25                            | 25   | ns   |
|   |  |                                  | 1.8 V ≤ EV <sub>DD</sub> ≤ 5.5 V |      |                              |      | 25                            | 25   |      |
|   |  |                                  | 1.6 V ≤ EV <sub>DD</sub> ≤ 5.5 V |      |                              |      |                               | 25   |      |

**Notes** 1. For CSI00, set a cycle of 2/f<sub>MCK</sub> or longer. For CSI01, set a cycle of 4/f<sub>MCK</sub> or longer.

2. When DAP<sub>mn</sub> = 0 and CKP<sub>mn</sub> = 0, or DAP<sub>mn</sub> = 1 and CKP<sub>mn</sub> = 1. The Slp setup time becomes “to SCKp↓” when DAP<sub>mn</sub> = 0 and CKP<sub>mn</sub> = 1, or DAP<sub>mn</sub> = 1 and CKP<sub>mn</sub> = 0.

3. When DAP<sub>mn</sub> = 0 and CKP<sub>mn</sub> = 0, or DAP<sub>mn</sub> = 1 and CKP<sub>mn</sub> = 1. The Slp hold time becomes “from SCKp↓” when DAP<sub>mn</sub> = 0 and CKP<sub>mn</sub> = 1, or DAP<sub>mn</sub> = 1 and CKP<sub>mn</sub> = 0.

4. When DAP<sub>mn</sub> = 0 and CKP<sub>mn</sub> = 0, or DAP<sub>mn</sub> = 1 and CKP<sub>mn</sub> = 1. The delay time to SOP output becomes “from SCKp↑” when DAP<sub>mn</sub> = 0 and CKP<sub>mn</sub> = 1, or DAP<sub>mn</sub> = 1 and CKP<sub>mn</sub> = 0.

5. C is the load capacitance of the SCKp and SOP output lines.

**Caution** Select the normal input buffer for the Slp pin and the normal output mode for the SOP pin and SCKp pin by using port input mode register g (PIMg) and port output mode register g (POMg).

(Remarks are listed on the next page.)

- Remarks 1.** p: CSI number (p = 00, 01), m: Unit number (m = 0), n: Channel number (n = 0, 1),  
g: PIM and POM numbers (g = 1)
- 2.** f<sub>MCK</sub>: Serial array unit operation clock frequency  
(Operation clock to be set by the serial clock select register m (SPSM) and the CKSMn bit of serial mode register mn (SMRmn).  
m: Unit number, n: Channel number (mn = 00, 01))

**(3) During communication at same potential (CSI mode) (slave mode, SCKp... external clock input) (1/2)**  
(T<sub>A</sub> = -40 to +85°C, 1.6 V ≤ EV<sub>DD</sub> = V<sub>DD</sub> ≤ 5.5 V, V<sub>SS</sub> = EV<sub>SS</sub> = 0 V)

| Parameter                                       | Symbol        | Conditions                       |                           | HS (high-speed main) Mode  |                                  | LS (low-speed main) Mode   |                    | LV (low-voltage main) Mode     |                    | Unit |    |
|---|---------------|----------------------------------|---------------------------|----------------------------|----------------------------------|----------------------------|--------------------|--------------------------------|--------------------|------|----|
|   |               |                                  |                           | MIN.                       | MAX.                             | MIN.                       | MAX.               | MIN.                           | MAX.               |      |    |
| SCKp cycle time <sup>Note 5</sup>               | tkCY2         | 4.0 V ≤ EV <sub>DD</sub> ≤ 5.5 V | 20 MHz < f <sub>MCK</sub> | 8/f <sub>MCK</sub>         |                                  |                            |                    |                                |                    | ns   |    |
|   |               |                                  | f <sub>MCK</sub> ≤ 20 MHz | 6/f <sub>MCK</sub>         |                                  | 6/f <sub>MCK</sub>         |                    | 6/f <sub>MCK</sub>             |                    | ns   |    |
|   |               | 2.7 V ≤ EV <sub>DD</sub> < 4.0 V | 16 MHz < f <sub>MCK</sub> | 8/f <sub>MCK</sub>         |                                  |                            |                    |                                |                    | ns   |    |
|   |               |                                  | f <sub>MCK</sub> ≤ 16 MHz | 6/f <sub>MCK</sub>         |                                  | 6/f <sub>MCK</sub>         |                    | 6/f <sub>MCK</sub>             |                    | ns   |    |
|   |               | 2.4 V ≤ EV <sub>DD</sub> ≤ 5.5 V |                           |                            | 6/f <sub>MCK</sub><br>and<br>500 |                            | 6/f <sub>MCK</sub> |                                | 6/f <sub>MCK</sub> |      | ns |
|   |               | 1.8 V ≤ EV <sub>DD</sub> < 2.4 V |                           |                            |                                  |                            | 6/f <sub>MCK</sub> |                                | 6/f <sub>MCK</sub> |      | ns |
|   |               | 1.6 V ≤ EV <sub>DD</sub> < 1.8 V |                           |                            |                                  |                            |                    |                                | 6/f <sub>MCK</sub> |      | ns |
| SCKp high-/low-level width                      | tkH2,<br>tkL2 | 4.0 V ≤ EV <sub>DD</sub> ≤ 5.5 V |                           | tkCY2/2<br>- 7             |                                  | tkCY2/2<br>- 7             |                    | tkCY2/2<br>- 7                 |                    | ns   |    |
|   |               | 2.7 V ≤ EV <sub>DD</sub> < 4.0 V |                           | tkCY2/2<br>- 8             |                                  | tkCY2/2<br>- 8             |                    | tkCY2/2<br>- 8                 |                    | ns   |    |
|   |               | 2.4 V ≤ EV <sub>DD</sub> < 2.7 V |                           | tkCY2/2<br>- 18            |                                  | tkCY2/2<br>- 18            |                    | tkCY2/2<br>- 18                |                    | ns   |    |
|   |               | 1.8 V ≤ EV <sub>DD</sub> < 2.4 V |                           |                            |                                  | tkCY2/2<br>- 18            |                    | tkCY2/2<br>- 18                |                    | ns   |    |
|   |               | 1.6 V ≤ EV <sub>DD</sub> < 1.8 V |                           |                            |                                  |                            |                    | tkCY2/2<br>- 66                |                    | ns   |    |
| Slp setup time<br>(to SCKp↑) <sup>Note 1</sup>  | tSIK2         | 2.7 V ≤ EV <sub>DD</sub> ≤ 5.5 V |                           | 1/f <sub>MCK</sub><br>+ 20 |                                  | 1/f <sub>MCK</sub><br>+ 30 |                    | 1/f <sub>MCK</sub><br>+ 30     |                    | ns   |    |
|   |               | 2.4 V ≤ EV <sub>DD</sub> < 2.7 V |                           | 1/f <sub>MCK</sub><br>+ 30 |                                  | 1/f <sub>MCK</sub><br>+ 30 |                    | 1/f <sub>MCK</sub><br>+ 30     |                    |      |    |
|   |               | 1.8 V ≤ EV <sub>DD</sub> < 2.4 V |                           |                            |                                  | 1/f <sub>MCK</sub><br>+ 30 |                    | 1/f <sub>MCK</sub><br>+ 30     |                    | ns   |    |
|   |               | 1.6 V ≤ EV <sub>DD</sub> < 1.8 V |                           |                            |                                  |                            |                    | 1/f <sub>MCK</sub><br>+ 40     |                    | ns   |    |
| Slp hold time<br>(from SCKp↑) <sup>Note 2</sup> | tSIH2         | 2.4 V ≤ EV <sub>DD</sub> ≤ 5.5 V |                           | 1/f <sub>MCK</sub><br>+ 31 |                                  | 1/f <sub>MCK</sub><br>+ 31 |                    | 1/f <sub>MCK</sub><br>+ 31     |                    | ns   |    |
|   |               | 1.8 V ≤ EV <sub>DD</sub> < 2.4 V |                           |                            |                                  | 1/f <sub>MCK</sub><br>+ 31 |                    | 1/f <sub>MCK</sub><br>+ 31     |                    | ns   |    |
|   |               | 1.6 V ≤ EV <sub>DD</sub> < 1.8 V |                           |                            |                                  |                            |                    | 1/f <sub>MCK</sub><br>+<br>250 |                    | ns   |    |

(Notes, Caution, and Remarks are listed on the next page.)

**(3) During communication at same potential (CSI mode) (slave mode, SCKp... external clock input) (2/2)**  
**(T<sub>A</sub> = -40 to +85°C, 1.6 V ≤ EV<sub>DD</sub> = V<sub>DD</sub> ≤ 5.5 V, V<sub>SS</sub> = EV<sub>SS</sub> = 0 V)**

| Parameter   | Symbol            | Conditions                  | HS<br>(high-speed<br>main)<br>Mode | LS (low-<br>speed<br>main)<br>Mode | LV (low-<br>voltage<br>main)<br>Mode | Unit                        | Para<br>meter | Symbol                      | Conditions                  |
|---|-------------------|-----------------------------|------------------------------------|------------------------------------|--------------------------------------|-----------------------------|---------------|-----------------------------|-----------------------------|
| Delay time from SCKp↓ to SOp output <sup>Note 3</sup> | t <sub>KSO2</sub> | C = 30 pF <sup>Note 4</sup> | 4.0 V ≤ EV <sub>DD</sub> ≤ 5.5 V   |                                    |                                      | 2/f <sub>MCK</sub><br>+ 110 |               | 2/f <sub>MCK</sub><br>+ 110 | ns                          |
|   |                   |                             | 2.7 V ≤ EV <sub>DD</sub> < 4.0 V   |                                    |                                      | 2/f <sub>MCK</sub><br>+ 44  |               | 2/f <sub>MCK</sub><br>+ 110 | ns                          |
|   |                   |                             | 2.4 V ≤ EV <sub>DD</sub> < 2.7 V   |                                    |                                      | 2/f <sub>MCK</sub><br>+ 75  |               | 2/f <sub>MCK</sub><br>+ 110 | ns                          |
|   |                   |                             | 1.8 V ≤ EV <sub>DD</sub> < 2.4 V   |                                    |                                      |                             |               | 2/f <sub>MCK</sub><br>+ 110 | ns                          |
|   |                   |                             | 1.6 V ≤ EV <sub>DD</sub> < 1.8 V   |                                    |                                      |                             |               |                             | 2/f <sub>MCK</sub><br>+ 220 |

- Notes**
1. When DAP<sub>mn</sub> = 0 and CKP<sub>mn</sub> = 0, or DAP<sub>mn</sub> = 1 and CKP<sub>mn</sub> = 1. The SIp setup time becomes “to SCKp↓” when DAP<sub>mn</sub> = 0 and CKP<sub>mn</sub> = 1, or DAP<sub>mn</sub> = 1 and CKP<sub>mn</sub> = 0.
  2. When DAP<sub>mn</sub> = 0 and CKP<sub>mn</sub> = 0, or DAP<sub>mn</sub> = 1 and CKP<sub>mn</sub> = 1. The SIp hold time becomes “from SCKp↓” when DAP<sub>mn</sub> = 0 and CKP<sub>mn</sub> = 1, or DAP<sub>mn</sub> = 1 and CKP<sub>mn</sub> = 0.
  3. When DAP<sub>mn</sub> = 0 and CKP<sub>mn</sub> = 0, or DAP<sub>mn</sub> = 1 and CKP<sub>mn</sub> = 1. The delay time to SOp output becomes “from SCKp↑” when DAP<sub>mn</sub> = 0 and CKP<sub>mn</sub> = 1, or DAP<sub>mn</sub> = 1 and CKP<sub>mn</sub> = 0.
  4. C is the load capacitance of the SCKp and SOp output lines.
  5. Transfer rate in the SNOOZE mode: MAX. 1 Mbps

**Caution** Select the normal input buffer for the SIp pin and SCKp pin and the normal output mode for the SOp pin by using port input mode register g (PIMg) and port output mode register g (POMg).

- Remarks**
1. p: CSI number (p = 00, 01), m: Unit number (m = 0),  
n: Channel number (n = 0, 1), g: PIM number (g = 1)
  2. f<sub>MCK</sub>: Serial array unit operation clock frequency  
(Operation clock to be set by the serial clock select register m (SPSm) and the CKSmn bit of serial mode register mn (SMRmn). m: Unit number, n: Channel number (mn = 00, 01))

**CSI mode connection diagram (during communication at same potential)**

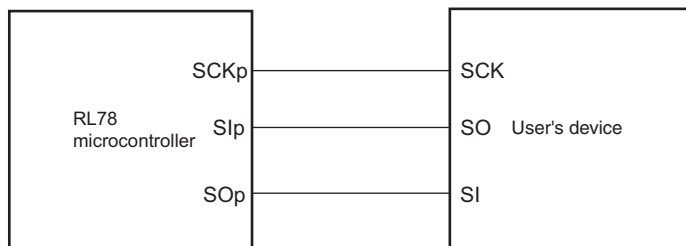

**CSI mode serial transfer timing (during communication at same potential)  
(When DAPmn = 0 and CKPmn = 0, or DAPmn = 1 and CKPmn = 1.)**

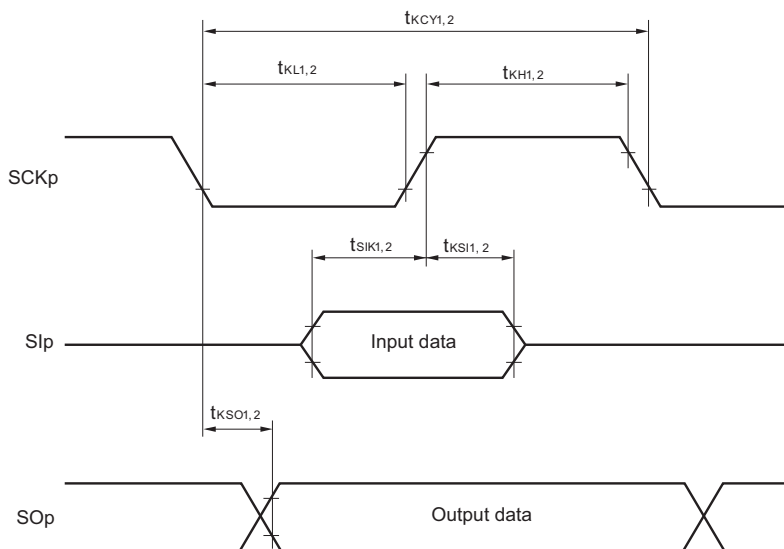

**CSI mode serial transfer timing (during communication at same potential)  
(When DAPmn = 0 and CKPmn = 1, or DAPmn = 1 and CKPmn = 0.)**

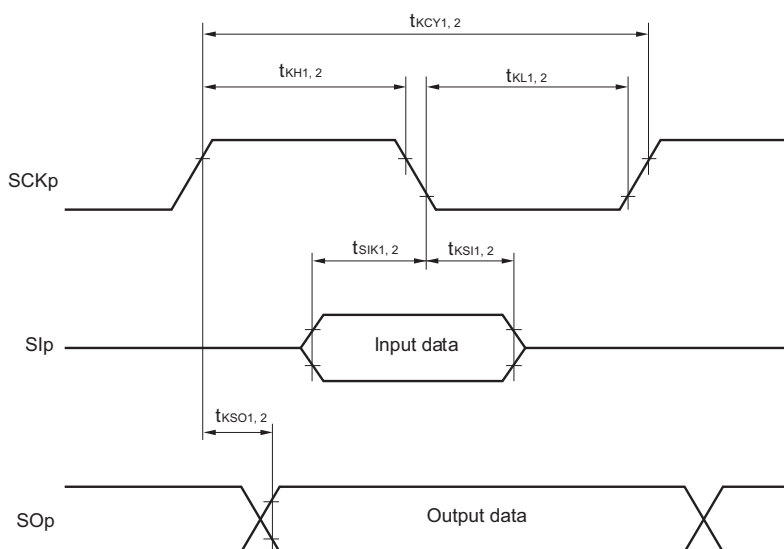

- Remarks 1. p: CSI number (p = 00, 01)
- 2. m: Unit number, n: Channel number (mn = 00, 01)

## (4) Communication at different potential (1.8 V, 2.5 V, 3 V) (UART mode)

(1/2)

(T<sub>A</sub> = -40 to +85°C, 1.8 V ≤ EV<sub>DD</sub> = V<sub>DD</sub> ≤ 5.5 V, V<sub>SS</sub> = EV<sub>SS</sub> = 0 V)

| Parameter     | Symbol | Conditions | HS (high-speed main) Mode   |      | LS (low-speed main) Mode   |      | LV (low-voltage main) Mode        |      | Unit                              |     |
|---------------|--------|------------|---|------|--|------|-----------------------------------|------|-----------------------------------|-----|
|               |        |            | MIN.  | MAX. | MIN.   | MAX. | MIN.                              | MAX. |                                   |     |
| Transfer rate |        | Reception  | 4.0 V ≤ EV <sub>DD</sub> ≤ 5.5 V,<br>2.7 V ≤ V <sub>b</sub> ≤ 4.0 V |      | f <sub>MCK</sub> /6<br>Note 1  |      | f <sub>MCK</sub> /6<br>Note 1     |      | f <sub>MCK</sub> /6<br>Note 1     | bps |
|               |        |            |   |      | Theoretical value of the maximum transfer rate<br>f <sub>MCK</sub> = f <sub>CLK</sub> Note 3 | 4.0  | 1.3                               | 0.6  | Mbps                              |     |
|               |        |            | 2.7 V ≤ EV <sub>DD</sub> < 4.0 V,<br>2.3 V ≤ V <sub>b</sub> ≤ 2.7 V |      | f <sub>MCK</sub> /6<br>Note 1  |      | f <sub>MCK</sub> /6<br>Note 1     |      | f <sub>MCK</sub> /6<br>Note 1     | bps |
|               |        |            |   |      | Theoretical value of the maximum transfer rate<br>f <sub>MCK</sub> = f <sub>CLK</sub> Note 3 | 4.0  | 1.3                               | 0.6  | Mbps                              |     |
|               |        |            | 2.4 V ≤ EV <sub>DD</sub> < 3.3 V,<br>1.6 V ≤ V <sub>b</sub> ≤ 2.0 V |      | f <sub>MCK</sub> /6<br>Note 1  |      | f <sub>MCK</sub> /6<br>Note 1     |      | f <sub>MCK</sub> /6<br>Note 1     | bps |
|               |        |            |   |      | Theoretical value of the maximum transfer rate<br>f <sub>MCK</sub> = f <sub>CLK</sub> Note 3 | 4.0  | 1.3                               | 0.6  | Mbps                              |     |
|               |        |            | 1.8 V ≤ EV <sub>DD</sub> < 3.3 V,<br>1.6 V ≤ V <sub>b</sub> ≤ 2.0 V |      |  |      | f <sub>MCK</sub> /6<br>Notes 1, 2 |      | f <sub>MCK</sub> /6<br>Notes 1, 2 | bps |
|               |        |            |   |      |  |      | 1.3                               | 0.6  | Mbps                              |     |

**Notes 1.** Transfer rate in the SNOOZE mode is 4800 bps only.**2.** Use it with EV<sub>DD</sub> ≥ V<sub>b</sub>.**3.** The maximum operating frequencies of the CPU/peripheral hardware clock (f<sub>CLK</sub>) are:HS (high-speed main) mode: 24 MHz (2.7 V ≤ V<sub>DD</sub> ≤ 5.5 V)16 MHz (2.4 V ≤ V<sub>DD</sub> ≤ 5.5 V)LS (low-speed main) mode: 8 MHz (1.8 V ≤ V<sub>DD</sub> ≤ 5.5 V)LV (low-voltage main) mode: 4 MHz (1.6 V ≤ V<sub>DD</sub> ≤ 5.5 V)

**Caution** Select the TTL input buffer for the Rx<sub>Dq</sub> pin and the N-ch open drain output (V<sub>DD</sub> tolerance (32-pin to 52-pin products)/EV<sub>DD</sub> tolerance (64-pin products)) mode for the Tx<sub>Dq</sub> pin by using port input mode register g (PIMg) and port output mode register g (POMg). For V<sub>IH</sub> and V<sub>IL</sub>, see the DC characteristics with TTL input buffer selected.

**Remarks 1.** V<sub>b</sub>[V]: Communication line voltage**2.** q: UART number (q = 0), g: PIM and POM number (g = 1)**3.** f<sub>MCK</sub>: Serial array unit operation clock frequency

(Operation clock to be set by the serial clock select register m (SPSm) and the CKSmn bit of serial mode register mn (SMRmn). m: Unit number, n: Channel number (mn = 00, 01))

**(4) Communication at different potential (1.8 V, 2.5 V, 3 V) (UART mode)**

**(2/2)**

(T<sub>A</sub> = -40 to +85°C, 1.8 V ≤ EV<sub>DD</sub> = V<sub>DD</sub> ≤ 5.5 V, V<sub>SS</sub> = EV<sub>SS</sub> = 0 V)

| Parameter     | Symbol | Conditions   | HS (high-speed main) Mode  |      | LS (low-speed main) Mode |      | LV (low-voltage main) Mode |      | Unit                   |      |
|---------------|--------|--------------|--|------|--------------------------|------|----------------------------|------|------------------------|------|
|               |        |              | MIN.   | MAX. | MIN.                     | MAX. | MIN.                       | MAX. |                        |      |
| Transfer rate |        | Transmission | 4.0 V ≤ EV <sub>DD</sub> ≤ 5.5 V,<br>2.7 V ≤ V <sub>b</sub> ≤ 4.0 V  |      | <b>Note 1</b>            |      | <b>Note 1</b>              |      | <b>Note 1</b>          | bps  |
|               |        |              | Theoretical value of the maximum transfer rate<br>C <sub>b</sub> = 50 pF, R <sub>b</sub> = 1.4 kΩ,<br>V <sub>b</sub> = 2.7 V |      | 2.8 <sup>Note 2</sup>    |      | 2.8 <sup>Note 2</sup>      |      | 2.8 <sup>Note 2</sup>  | Mbps |
|               |        |              | 2.7 V ≤ EV <sub>DD</sub> < 4.0 V,<br>2.3 V ≤ V <sub>b</sub> ≤ 2.7 V  |      | <b>Note 3</b>            |      | <b>Note 3</b>              |      | <b>Note 3</b>          | bps  |
|               |        |              | Theoretical value of the maximum transfer rate<br>C <sub>b</sub> = 50 pF, R <sub>b</sub> = 2.7 kΩ,<br>V <sub>b</sub> = 2.3 V |      | 1.2 <sup>Note 4</sup>    |      | 1.2 <sup>Note 4</sup>      |      | 1.2 <sup>Note 4</sup>  | Mbps |
|               |        |              | 2.4 V ≤ EV <sub>DD</sub> < 3.3 V,<br>1.6 V ≤ V <sub>b</sub> ≤ 2.0 V  |      | <b>Note 6</b>            |      | <b>Note 6</b>              |      | <b>Note 6</b>          | bps  |
|               |        |              | Theoretical value of the maximum transfer rate<br>C <sub>b</sub> = 50 pF, R <sub>b</sub> = 5.5 kΩ,<br>V <sub>b</sub> = 1.6 V |      | 0.43 <sup>Note 7</sup>   |      | 0.43 <sup>Note 7</sup>     |      | 0.43 <sup>Note 7</sup> | Mbps |
|               |        |              | 1.8 V ≤ EV <sub>DD</sub> < 3.3 V,<br>1.6 V ≤ V <sub>b</sub> ≤ 2.0 V  |      |                          |      | <b>Notes 5, 6</b>          |      | <b>Notes 5, 6</b>      | bps  |
|               |        |              | Theoretical value of the maximum transfer rate<br>C <sub>b</sub> = 50 pF, R <sub>b</sub> = 5.5 kΩ,<br>V <sub>b</sub> = 1.6 V |      |                          |      | 0.43 <sup>Note 7</sup>     |      | 0.43 <sup>Note 7</sup> | Mbps |

**Notes 1.** The smaller maximum transfer rate derived by using f<sub>MCK</sub>/6 or the following expression is the valid maximum transfer rate.

Expression for calculating the transfer rate when 4.0 V ≤ EV<sub>DD</sub> ≤ 5.5 V and 2.7 V ≤ V<sub>b</sub> ≤ 4.0 V

$$\text{Maximum transfer rate} = \frac{1}{\{-C_b \times R_b \times \ln(1 - \frac{2.2}{V_b})\} \times 3} \text{ [bps]}$$

$$\text{Baud rate error (theoretical value)} = \frac{\frac{1}{\text{Transfer rate} \times 2} - \{-C_b \times R_b \times \ln(1 - \frac{2.2}{V_b})\}}{(\frac{1}{\text{Transfer rate}}) \times \text{Number of transferred bits}} \times 100 \text{ [%]}$$

\* This value is the theoretical value of the relative difference between the transmission and reception sides.

- 2.** This value as an example is calculated when the conditions described in the “Conditions” column are met. Refer to Note 1 above to calculate the maximum transfer rate under conditions of the customer.

3. The smaller maximum transfer rate derived by using  $f_{MCK}/6$  or the following expression is the valid maximum transfer rate.

Expression for calculating the transfer rate when  $2.7\text{ V} \leq EV_{DD} < 4.0\text{ V}$  and  $2.3\text{ V} \leq V_b \leq 2.7\text{ V}$

$$\text{Maximum transfer rate} = \frac{1}{\{-C_b \times R_b \times \ln(1 - \frac{2.0}{V_b})\} \times 3} \text{ [bps]}$$

$$\text{Baud rate error (theoretical value)} = \frac{\frac{1}{\text{Transfer rate} \times 2} - \{-C_b \times R_b \times \ln(1 - \frac{2.0}{V_b})\}}{(\frac{1}{\text{Transfer rate}}) \times \text{Number of transferred bits}} \times 100 \text{ [%]}$$

\* This value is the theoretical value of the relative difference between the transmission and reception sides.

4. This value as an example is calculated when the conditions described in the “Conditions” column are met. Refer to Note 3 above to calculate the maximum transfer rate under conditions of the customer.
5. Use it with  $EV_{DD} \geq V_b$ .

6. The smaller maximum transfer rate derived by using  $f_{MCK}/6$  or the following expression is the valid maximum transfer rate.

Expression for calculating the transfer rate when  $1.8\text{ V} \leq EV_{DD} < 3.3\text{ V}$  and  $1.6\text{ V} \leq V_b \leq 2.0\text{ V}$

$$\text{Maximum transfer rate} = \frac{1}{\{-C_b \times R_b \times \ln(1 - \frac{1.5}{V_b})\} \times 3} \text{ [bps]}$$

$$\text{Baud rate error (theoretical value)} = \frac{\frac{1}{\text{Transfer rate} \times 2} - \{-C_b \times R_b \times \ln(1 - \frac{1.5}{V_b})\}}{(\frac{1}{\text{Transfer rate}}) \times \text{Number of transferred bits}} \times 100 \text{ [%]}$$

\* This value is the theoretical value of the relative difference between the transmission and reception sides.

7. This value as an example is calculated when the conditions described in the “Conditions” column are met. Refer to Note 6 above to calculate the maximum transfer rate under conditions of the customer.

**Caution** Select the TTL input buffer for the RxDq pin and the N-ch open drain output ( $V_{DD}$  tolerance (32-pin to 52-pin products)/ $EV_{DD}$  tolerance (64-pin products)) mode for the TxDq pin by using port input mode register g (PIMg) and port output mode register g (POMg). For  $V_{IH}$  and  $V_{IL}$ , see the DC characteristics with TTL input buffer selected.

**UART mode connection diagram (during communication at different potential)**

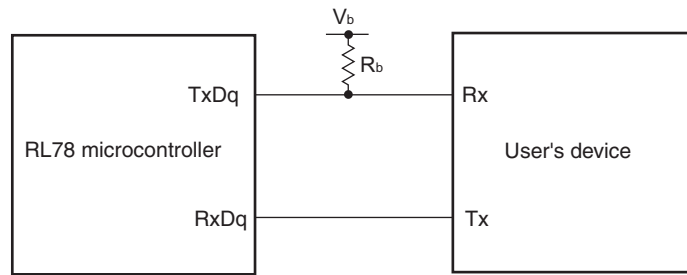

**UART mode bit width (during communication at different potential) (reference)**

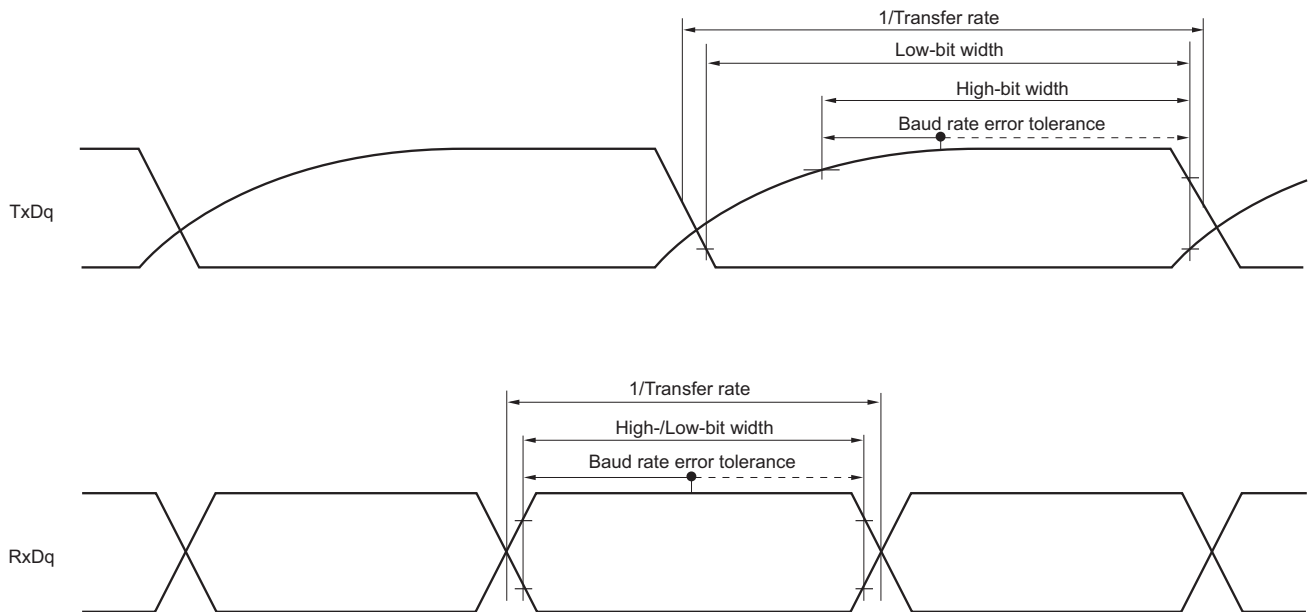

- Remarks 1.**  $R_b[\Omega]$ : Communication line (TxDq) pull-up resistance,  
 $C_b[F]$ : Communication line (TxDq) load capacitance,  $V_b[V]$ : Communication line voltage
- 2.** q: UART number (q = 0, 1), g: PIM and POM number (g = 1)
- 3.**  $f_{mck}$ : Serial array unit operation clock frequency  
 (Operation clock to be set by the serial clock select register m (SPSm) and the CKSmn bit of serial mode register mn (SMRmn). m: Unit number, n: Channel number (mn = 00, 01))



**(5) Communication at different potential (2.5 V, 3 V) (CSI mode) (master mode, SCKp... internal clock output, corresponding CSI00 only)****(T<sub>A</sub> = -40 to +85°C, 2.7 V ≤ EV<sub>DD</sub> = V<sub>DD</sub> ≤ 5.5 V, V<sub>SS</sub> = EV<sub>SS</sub> = 0 V)**

| Parameter  | Symbol            | Conditions  | HS (high-speed main) Mode     |      | LS (low-speed main) Mode      |      | LV (low-voltage main) Mode    |      | Unit |
|--|-------------------|---|-------------------------------|------|-------------------------------|------|-------------------------------|------|------|
|  |                   |   | MIN.                          | MAX. | MIN.                          | MAX. | MIN.                          | MAX. |      |
| SCKp cycle time  | t <sub>KCY1</sub> | t <sub>KCY1</sub> ≥ 2/f <sub>CLK</sub><br>4.0 V ≤ EV <sub>DD</sub> ≤ 5.5 V,<br>2.7 V ≤ V <sub>b</sub> ≤ 4.0 V,<br>C <sub>b</sub> = 20 pF, R <sub>b</sub> = 1.4 kΩ | 200<br>Note 1                 |      | 1150<br>Note 1                |      | 1150<br>Note 1                |      | ns   |
|  |                   |   | 300<br>Note 1                 |      | 1150<br>Note 1                |      | 1150<br>Note 1                |      | ns   |
| SCKp high-level width                                    | t <sub>KH1</sub>  | 4.0 V ≤ EV <sub>DD</sub> ≤ 5.5 V, 2.7 V ≤ V <sub>b</sub> ≤ 4.0 V,<br>C <sub>b</sub> = 20 pF, R <sub>b</sub> = 1.4 kΩ  | t <sub>KCY1</sub> /2<br>- 50  |      | t <sub>KCY1</sub> /2<br>- 50  |      | t <sub>KCY1</sub> /2<br>- 50  |      | ns   |
|  |                   | 2.7 V ≤ EV <sub>DD</sub> < 4.0 V, 2.3 V ≤ V <sub>b</sub> ≤ 2.7 V,<br>C <sub>b</sub> = 20 pF, R <sub>b</sub> = 2.7 kΩ  | t <sub>KCY1</sub> /2<br>- 120 |      | t <sub>KCY1</sub> /2<br>- 120 |      | t <sub>KCY1</sub> /2<br>- 120 |      | ns   |
| SCKp low-level width                                     | t <sub>KL1</sub>  | 4.0 V ≤ EV <sub>DD</sub> ≤ 5.5 V, 2.7 V ≤ V <sub>b</sub> ≤ 4.0 V,<br>C <sub>b</sub> = 20 pF, R <sub>b</sub> = 1.4 kΩ  | t <sub>KCY1</sub> /2<br>- 7   |      | t <sub>KCY1</sub> /2<br>- 50  |      | t <sub>KCY1</sub> /2<br>- 50  |      | ns   |
|  |                   | 2.7 V ≤ EV <sub>DD</sub> < 4.0 V, 2.3 V ≤ V <sub>b</sub> ≤ 2.7 V,<br>C <sub>b</sub> = 20 pF, R <sub>b</sub> = 2.7 kΩ  | t <sub>KCY1</sub> /2<br>- 10  |      | t <sub>KCY1</sub> /2<br>- 50  |      | t <sub>KCY1</sub> /2<br>- 50  |      | ns   |
| Slp setup time<br>(to SCKp↑) <sup>Note 2</sup>           | t <sub>SIK1</sub> | 4.0 V ≤ EV <sub>DD</sub> ≤ 5.5 V, 2.7 V ≤ V <sub>b</sub> ≤ 4.0 V,<br>C <sub>b</sub> = 20 pF, R <sub>b</sub> = 1.4 kΩ  | 58                            |      | 479                           |      | 479                           |      | ns   |
|  |                   | 2.7 V ≤ EV <sub>DD</sub> < 4.0 V, 2.3 V ≤ V <sub>b</sub> ≤ 2.7 V,<br>C <sub>b</sub> = 20 pF, R <sub>b</sub> = 2.7 kΩ  | 121                           |      | 479                           |      | 479                           |      | ns   |
| Slp hold time<br>(from SCKp↑) <sup>Note 2</sup>          | t <sub>KSH1</sub> | 4.0 V ≤ EV <sub>DD</sub> ≤ 5.5 V, 2.7 V ≤ V <sub>b</sub> ≤ 4.0 V,<br>C <sub>b</sub> = 20 pF, R <sub>b</sub> = 1.4 kΩ  | 10                            |      | 10                            |      | 10                            |      | ns   |
|  |                   | 2.7 V ≤ EV <sub>DD</sub> < 4.0 V, 2.3 V ≤ V <sub>b</sub> ≤ 2.7 V,<br>C <sub>b</sub> = 20 pF, R <sub>b</sub> = 2.7 kΩ  | 10                            |      | 10                            |      | 10                            |      | ns   |
| Delay time from SCKp↓ to<br>SOp output <sup>Note 2</sup> | t <sub>KSO1</sub> | 4.0 V ≤ EV <sub>DD</sub> ≤ 5.5 V, 2.7 V ≤ V <sub>b</sub> ≤ 4.0 V,<br>C <sub>b</sub> = 20 pF, R <sub>b</sub> = 1.4 kΩ  |                               | 60   |                               | 60   |                               | 60   | ns   |
|  |                   | 2.7 V ≤ EV <sub>DD</sub> < 4.0 V, 2.3 V ≤ V <sub>b</sub> ≤ 2.7 V,<br>C <sub>b</sub> = 20 pF, R <sub>b</sub> = 2.7 kΩ  |                               | 130  |                               | 130  |                               | 130  | ns   |
| Slp setup time<br>(to SCKp↓) <sup>Note 3</sup>           | t <sub>SIK1</sub> | 4.0 V ≤ EV <sub>DD</sub> ≤ 5.5 V, 2.7 V ≤ V <sub>b</sub> ≤ 4.0 V,<br>C <sub>b</sub> = 20 pF, R <sub>b</sub> = 1.4 kΩ  | 23                            |      | 110                           |      | 110                           |      | ns   |
|  |                   | 2.7 V ≤ EV <sub>DD</sub> < 4.0 V, 2.3 V ≤ V <sub>b</sub> ≤ 2.7 V,<br>C <sub>b</sub> = 20 pF, R <sub>b</sub> = 2.7 kΩ  | 33                            |      | 110                           |      | 110                           |      | ns   |
| Slp hold time<br>(from SCKp↓) <sup>Note 3</sup>          | t <sub>KSH1</sub> | 4.0 V ≤ EV <sub>DD</sub> ≤ 5.5 V, 2.7 V ≤ V <sub>b</sub> ≤ 4.0 V,<br>C <sub>b</sub> = 20 pF, R <sub>b</sub> = 1.4 kΩ  | 10                            |      | 10                            |      | 10                            |      | ns   |
|  |                   | 2.7 V ≤ EV <sub>DD</sub> < 4.0 V, 2.3 V ≤ V <sub>b</sub> ≤ 2.7 V,<br>C <sub>b</sub> = 20 pF, R <sub>b</sub> = 2.7 kΩ  | 10                            |      | 10                            |      | 10                            |      | ns   |
| Delay time from SCKp↑ to<br>SOp output <sup>Note 3</sup> | t <sub>KSO1</sub> | 4.0 V ≤ EV <sub>DD</sub> ≤ 5.5 V, 2.7 V ≤ V <sub>b</sub> ≤ 4.0 V,<br>C <sub>b</sub> = 20 pF, R <sub>b</sub> = 1.4 kΩ  |                               | 10   |                               | 10   |                               | 10   | ns   |
|  |                   | 2.7 V ≤ EV <sub>DD</sub> < 4.0 V, 2.3 V ≤ V <sub>b</sub> ≤ 2.7 V,<br>C <sub>b</sub> = 20 pF, R <sub>b</sub> = 2.7 kΩ  |                               | 10   |                               | 10   |                               | 10   | ns   |

(Notes, Caution and Remarks are listed on the next page.)

- Notes**
1. For CSI00, set a cycle of  $2/f_{MCK}$  or longer. For CSI01, set a cycle of  $4/f_{MCK}$  or longer.
  2. When DAP<sub>mn</sub> = 0 and CKP<sub>mn</sub> = 0, or DAP<sub>mn</sub> = 1 and CKP<sub>mn</sub> = 1.
  3. When DAP<sub>mn</sub> = 0 and CKP<sub>mn</sub> = 1, or DAP<sub>mn</sub> = 1 and CKP<sub>mn</sub> = 0.

**Caution** Select the TTL input buffer for the SIp pin and the N-ch open drain output (V<sub>DD</sub> tolerance (32-pin to 52-pin products)/EV<sub>DD</sub> tolerance (64-pin products)) mode for the SOp pin and SCKp pin by using port input mode register g (PIMg) and port output mode register g (POMg). For V<sub>IH</sub> and V<sub>IL</sub>, see the DC characteristics with TTL input buffer selected.

- Remarks**
1. R<sub>b</sub>[Ω]: Communication line (SCKp, SOp) pull-up resistance, C<sub>b</sub>[F]: Communication line (SCKp, SOp) load capacitance, V<sub>b</sub>[V]: Communication line voltage
  2. p: CSI number (p = 00, 01), m: Unit number (m = 0), n: Channel number (n = 0, 1),  
g: PIM and POM number (g = 1)
  3. f<sub>MCK</sub>: Serial array unit operation clock frequency  
(Operation clock to be set by the serial clock select register m (SPSm) and the CKSmn bit of serial mode register mn (SMRmn). m: Unit number, n: Channel number (mn = 00, 01))

**(6) Communication at different potential (1.8 V, 2.5 V, 3 V) (CSI mode) (master mode, SCKp... internal clock output) (1/3)**  
**(T<sub>A</sub> = -40 to +85°C, 1.8 V ≤ EV<sub>DD</sub> = V<sub>DD</sub> ≤ 5.5 V, V<sub>SS</sub> = EV<sub>SS</sub> = 0 V)**

| Parameter             | Symbol            | Conditions  | HS (high-speed main) Mode |       | LS (low-speed main) Mode |       | LV (low-voltage main) Mode |       | Unit |
|-----------------------|-------------------|---|---------------------------|-------|--------------------------|-------|----------------------------|-------|------|
|                       |                   |   | MIN.                      | MAX.  | MIN.                     | MAX.  | MIN.                       | MAX.  |      |
| SCKp cycle time       | t <sub>KCY1</sub> | t <sub>KCY1</sub> ≥ 4/f <sub>CLK</sub><br>4.0 V ≤ EV <sub>DD</sub> ≤ 5.5 V,<br>2.7 V ≤ V <sub>b</sub> ≤ 4.0 V,<br>C <sub>b</sub> = 30 pF, R <sub>b</sub> = 1.4 kΩ | 300                       |       | 1150                     |       | 1150                       |       | ns   |
|                       |                   |   | 500                       |       | 1150                     |       | 1150                       |       | ns   |
|                       |                   |   | 1150                      |       | 1150                     |       | 1150                       |       | ns   |
|                       |                   |   |                           |       | 1150                     |       | 1150                       |       | ns   |
| SCKp high-level width | t <sub>KH1</sub>  | 4.0 V ≤ EV <sub>DD</sub> ≤ 5.5 V, 2.7 V ≤ V <sub>b</sub> ≤ 4.0 V,<br>C <sub>b</sub> = 30 pF, R <sub>b</sub> = 1.4 kΩ  | t <sub>KCY1</sub> /2      | - 75  | t <sub>KCY1</sub> /2     | - 75  | t <sub>KCY1</sub> /2       | - 75  | ns   |
|                       |                   |   | t <sub>KCY1</sub> /2      | - 170 | t <sub>KCY1</sub> /2     | - 170 | t <sub>KCY1</sub> /2       | - 170 | ns   |
|                       |                   |   | t <sub>KCY1</sub> /2      | - 458 | t <sub>KCY1</sub> /2     | - 458 | t <sub>KCY1</sub> /2       | - 458 | ns   |
|                       |                   |   |                           |       | t <sub>KCY1</sub> /2     | - 458 | t <sub>KCY1</sub> /2       | - 458 | ns   |
| SCKp low-level width  | t <sub>KL1</sub>  | 4.0 V ≤ EV <sub>DD</sub> ≤ 5.5 V, 2.7 V ≤ V <sub>b</sub> ≤ 4.0 V,<br>C <sub>b</sub> = 30 pF, R <sub>b</sub> = 1.4 kΩ  | t <sub>KCY1</sub> /2      | - 12  | t <sub>KCY1</sub> /2     | - 50  | t <sub>KCY1</sub> /2       | - 50  | ns   |
|                       |                   |   | t <sub>KCY1</sub> /2      | - 18  | t <sub>KCY1</sub> /2     | - 50  | t <sub>KCY1</sub> /2       | - 50  | ns   |
|                       |                   |   | t <sub>KCY1</sub> /2      | - 50  | t <sub>KCY1</sub> /2     | - 50  | t <sub>KCY1</sub> /2       | - 50  | ns   |
|                       |                   |   |                           |       | t <sub>KCY1</sub> /2     | - 50  | t <sub>KCY1</sub> /2       | - 50  | ns   |

**Note** Use it with EV<sub>DD</sub> ≥ V<sub>b</sub>.

**Caution** Select the TTL input buffer for the SIp pin and the N-ch open drain output (V<sub>DD</sub> tolerance (32-pin to 52-pin products)/EV<sub>DD</sub> tolerance (64-pin products)) mode for the SOp pin and SCKp pin by using port input mode register g (PIMg) and port output mode register g (POMg). For V<sub>IH</sub> and V<sub>IL</sub>, see the DC characteristics with TTL input buffer selected.

**(6) Communication at different potential (1.8 V, 2.5 V, 3 V) (CSI mode) (master mode, SCKp... internal clock output) (2/3)**  
**(T<sub>A</sub> = -40 to +85°C, 1.8 V ≤ EV<sub>DD</sub> = V<sub>DD</sub> ≤ 5.5 V, V<sub>SS</sub> = EV<sub>SS</sub> = 0 V)**

| Parameter   | Symbol | Conditions   | HS (high-speed main) Mode |      | LS (low-speed main) Mode |      | LV (low-voltage main) Mode |      | Unit |
|---|--------|--|---------------------------|------|--------------------------|------|----------------------------|------|------|
|   |        |  | MIN.                      | MAX. | MIN.                     | MAX. | MIN.                       | MAX. |      |
| Slp setup time (to SCKp↑) <sup>Note 1</sup>           | tsIK1  | 4.0 V ≤ EV <sub>DD</sub> ≤ 5.5 V, 2.7 V ≤ V <sub>b</sub> ≤ 4.0 V, C <sub>b</sub> = 30 pF, R <sub>b</sub> = 1.4 kΩ                    | 81                        |      | 479                      |      | 479                        |      | ns   |
|   |        | 2.7 V ≤ EV <sub>DD</sub> < 4.0 V, 2.3 V ≤ V <sub>b</sub> ≤ 2.7 V, C <sub>b</sub> = 30 pF, R <sub>b</sub> = 2.7 kΩ                    | 177                       |      | 479                      |      | 479                        |      | ns   |
|   |        | 2.4 V ≤ EV <sub>DD</sub> < 3.3 V, 1.6 V ≤ V <sub>b</sub> ≤ 2.0 V, C <sub>b</sub> = 30 pF, R <sub>b</sub> = 5.5 kΩ                    | 479                       |      | 479                      |      | 479                        |      | ns   |
|   |        | 1.8 V ≤ EV <sub>DD</sub> < 3.3 V, 1.6 V ≤ V <sub>b</sub> ≤ 2.0 V <sup>Note 3</sup> , C <sub>b</sub> = 30 pF, R <sub>b</sub> = 5.5 kΩ |                           |      | 479                      |      | 479                        |      | ns   |
| Slp hold time (from SCKp↑) <sup>Note 1</sup>          | tkSI1  | 4.0 V ≤ EV <sub>DD</sub> ≤ 5.5 V, 2.7 V ≤ V <sub>b</sub> ≤ 4.0 V, C <sub>b</sub> = 30 pF, R <sub>b</sub> = 1.4 kΩ                    | 19                        |      | 19                       |      | 19                         |      | ns   |
|   |        | 2.7 V ≤ EV <sub>DD</sub> < 4.0 V, 2.3 V ≤ V <sub>b</sub> ≤ 2.7 V, C <sub>b</sub> = 30 pF, R <sub>b</sub> = 2.7 kΩ                    | 19                        |      | 19                       |      | 19                         |      | ns   |
|   |        | 2.4 V ≤ EV <sub>DD</sub> < 3.3 V, 1.6 V ≤ V <sub>b</sub> ≤ 2.0 V, C <sub>b</sub> = 30 pF, R <sub>b</sub> = 5.5 kΩ                    | 19                        |      | 19                       |      | 19                         |      | ns   |
|   |        | 1.8 V ≤ EV <sub>DD</sub> < 3.3 V, 1.6 V ≤ V <sub>b</sub> ≤ 2.0 V <sup>Note 3</sup> , C <sub>b</sub> = 30 pF, R <sub>b</sub> = 5.5 kΩ |                           |      | 19                       |      | 19                         |      | ns   |
| Delay time from SCKp↓ to SOP output <sup>Note 1</sup> | tkSO1  | 4.0 V ≤ EV <sub>DD</sub> ≤ 5.5 V, 2.7 V ≤ V <sub>b</sub> ≤ 4.0 V, C <sub>b</sub> = 30 pF, R <sub>b</sub> = 1.4 kΩ                    |                           | 100  |                          | 100  |                            | 100  | ns   |
|   |        | 2.7 V ≤ EV <sub>DD</sub> < 4.0 V, 2.3 V ≤ V <sub>b</sub> ≤ 2.7 V, C <sub>b</sub> = 30 pF, R <sub>b</sub> = 2.7 kΩ                    |                           | 195  |                          | 195  |                            | 195  | ns   |
|   |        | 2.4 V ≤ EV <sub>DD</sub> < 4.0 V, 2.3 V ≤ V <sub>b</sub> ≤ 2.7 V, C <sub>b</sub> = 30 pF, R <sub>b</sub> = 2.7 kΩ                    |                           | 483  |                          | 483  |                            | 483  | ns   |
|   |        | 1.8 V ≤ EV <sub>DD</sub> < 3.3 V, 1.6 V ≤ V <sub>b</sub> ≤ 2.0 V <sup>Note 3</sup> , C <sub>b</sub> = 30 pF, R <sub>b</sub> = 5.5 kΩ |                           |      |                          | 483  |                            | 483  | ns   |
| Slp setup time (to SCKp↓) <sup>Note 2</sup>           | tsIK1  | 4.0 V ≤ EV <sub>DD</sub> ≤ 5.5 V, 2.7 V ≤ V <sub>b</sub> ≤ 4.0 V, C <sub>b</sub> = 30 pF, R <sub>b</sub> = 1.4 kΩ                    | 44                        |      | 110                      |      | 110                        |      | ns   |
|   |        | 2.7 V ≤ EV <sub>DD</sub> < 4.0 V, 2.3 V ≤ V <sub>b</sub> ≤ 2.7 V, C <sub>b</sub> = 30 pF, R <sub>b</sub> = 2.7 kΩ                    | 44                        |      | 110                      |      | 110                        |      | ns   |
|   |        | 2.4 V ≤ EV <sub>DD</sub> < 4.0 V, 2.3 V ≤ V <sub>b</sub> ≤ 2.7 V, C <sub>b</sub> = 30 pF, R <sub>b</sub> = 2.7 kΩ                    | 110                       |      | 110                      |      | 110                        |      | ns   |
|   |        | 1.8 V ≤ EV <sub>DD</sub> < 3.3 V, 1.6 V ≤ V <sub>b</sub> ≤ 2.0 V <sup>Note 3</sup> , C <sub>b</sub> = 30 pF, R <sub>b</sub> = 5.5 kΩ |                           |      | 110                      |      | 110                        |      | ns   |

- Notes**
1. When DAPmn = 0 and CKPmn = 0, or DAPmn = 1 and CKPmn = 1.
  2. When DAPmn = 0 and CKPmn = 1, or DAPmn = 1 and CKPmn = 0.
  3. Use it with EV<sub>DD</sub> ≥ V<sub>b</sub>.

**Caution** Select the TTL input buffer for the Slp pin and the N-ch open drain output (V<sub>DD</sub> tolerance (32-pin to 52-pin products)/EV<sub>DD</sub> tolerance (64-pin products)) mode for the SOP pin and SCKp pin by using port input mode register g (PIMg) and port output mode register g (POMg). For V<sub>IH</sub> and V<sub>IL</sub>, see the DC characteristics with TTL input buffer selected.

**(6) Communication at different potential (1.8 V, 2.5 V, 3 V) (CSI mode) (master mode, SCKp... internal clock output) (3/3)**  
**(T<sub>A</sub> = -40 to +85°C, 1.8 V ≤ EV<sub>DD</sub> = V<sub>DD</sub> ≤ 5.5 V, V<sub>SS</sub> = EV<sub>SS</sub> = 0 V)**

| Parameter   | Symbol            | Conditions   | HS (high-speed main) Mode |      | LS (low-speed main) Mode |      | LV (low-voltage main) Mode |      | Unit |
|---|-------------------|--|---------------------------|------|--------------------------|------|----------------------------|------|------|
|   |                   |  | MIN.                      | MAX. | MIN.                     | MAX. | MIN.                       | MAX. |      |
| Slp hold time (from SCKp↓) <sup>Note 2</sup>          | t <sub>KSI1</sub> | 4.0 V ≤ EV <sub>DD</sub> ≤ 5.5 V, 2.7 V ≤ V <sub>b</sub> ≤ 4.0 V, C <sub>b</sub> = 30 pF, R <sub>b</sub> = 1.4 kΩ                    | 19                        |      | 19                       |      | 19                         |      | ns   |
|   |                   | 2.7 V ≤ EV <sub>DD</sub> < 4.0 V, 2.3 V ≤ V <sub>b</sub> ≤ 2.7 V, C <sub>b</sub> = 30 pF, R <sub>b</sub> = 2.7 kΩ                    | 19                        |      | 19                       |      | 19                         |      | ns   |
|   |                   | 2.4 V ≤ EV <sub>DD</sub> < 3.3 V, 1.6 V ≤ V <sub>b</sub> ≤ 2.0 V, C <sub>b</sub> = 30 pF, R <sub>b</sub> = 5.5 kΩ                    | 19                        |      | 19                       |      | 19                         |      | ns   |
|   |                   | 1.8 V ≤ EV <sub>DD</sub> < 3.3 V, 1.6 V ≤ V <sub>b</sub> ≤ 2.0 V <sup>Note 3</sup> , C <sub>b</sub> = 30 pF, R <sub>b</sub> = 5.5 kΩ |                           |      | 19                       |      | 19                         |      | ns   |
| Delay time from SCKp↑ to SOp output <sup>Note 2</sup> | t <sub>KSO1</sub> | 4.0 V ≤ EV <sub>DD</sub> ≤ 5.5 V, 2.7 V ≤ V <sub>b</sub> ≤ 4.0 V, C <sub>b</sub> = 30 pF, R <sub>b</sub> = 1.4 kΩ                    |                           | 25   |                          | 25   |                            | 25   | ns   |
|   |                   | 2.7 V ≤ EV <sub>DD</sub> < 4.0 V, 2.3 V ≤ V <sub>b</sub> ≤ 2.7 V, C <sub>b</sub> = 30 pF, R <sub>b</sub> = 2.7 kΩ                    |                           | 25   |                          | 25   |                            | 25   | ns   |
|   |                   | 2.4 V ≤ EV <sub>DD</sub> < 3.3 V, 1.6 V ≤ V <sub>b</sub> ≤ 2.0 V, C <sub>b</sub> = 30 pF, R <sub>b</sub> = 5.5 kΩ                    |                           | 25   |                          | 25   |                            | 25   | ns   |
|   |                   | 1.8 V ≤ EV <sub>DD</sub> < 3.3 V, 1.6 V ≤ V <sub>b</sub> ≤ 2.0 V <sup>Note 3</sup> , C <sub>b</sub> = 30 pF, R <sub>b</sub> = 5.5 kΩ |                           |      |                          | 25   |                            | 25   | ns   |

- Notes**
1. When DAPmn = 0 and CKPmn = 0, or DAPmn = 1 and CKPmn = 1.
  2. When DAPmn = 0 and CKPmn = 1, or DAPmn = 1 and CKPmn = 0.
  3. Use it with EV<sub>DD</sub> ≥ V<sub>b</sub>.

**Caution** Select the TTL input buffer for the Slp pin and the N-ch open drain output (V<sub>DD</sub> tolerance (32-pin to 52-pin products)/EV<sub>DD</sub> tolerance (64-pin products)) mode for the SOp pin and SCKp pin by using port input mode register g (PIMg) and port output mode register g (POMg). For V<sub>IH</sub> and V<sub>IL</sub>, see the DC characteristics with TTL input buffer selected.

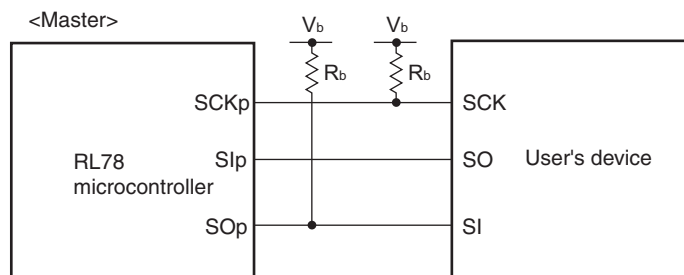
**CSI mode connection diagram (during communication at different potential)**

- Remarks**
1.  $R_b[\Omega]$ : Communication line (SCKp, SOp) pull-up resistance,  $C_b[F]$ : Communication line (SCKp, SOp) load capacitance,  $V_b[V]$ : Communication line voltage
  2. p: CSI number (p = 00, 01), m: Unit number (m = 0), n: Channel number (n = 0, 1), g: PIM and POM number (g = 1)
  3.  $f_{MCK}$ : Serial array unit operation clock frequency  
(Operation clock to be set by the serial clock select register m (SPSm) and the CKSmn bit of serial mode register mn (SMRmn). m: Unit number, n: Channel number (mn = 00, 01))

**CSI mode serial transfer timing (master mode) (during communication at different potential)  
(When DAPmn = 0 and CKPmn = 0, or DAPmn = 1 and CKPmn = 1.)**

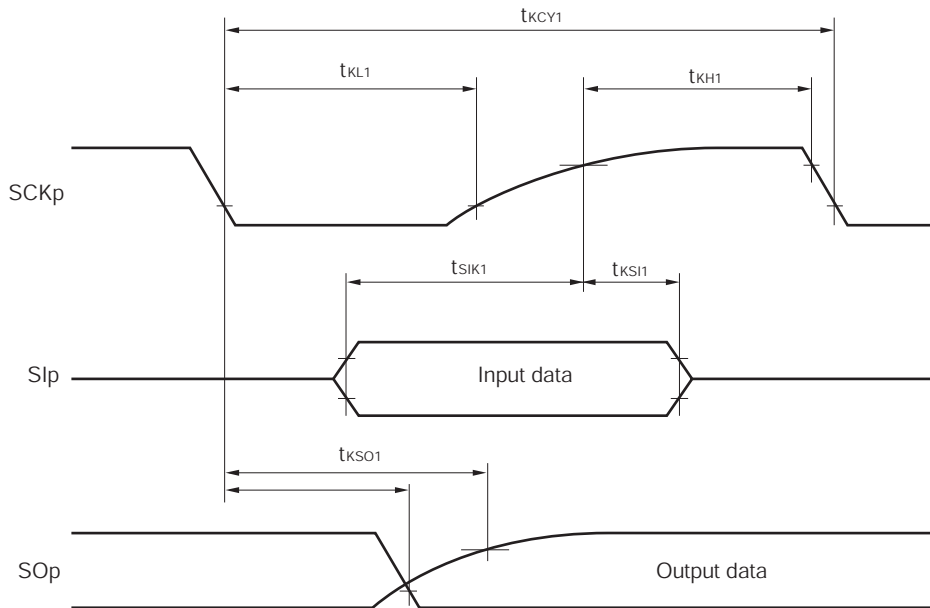

**CSI mode serial transfer timing (master mode) (during communication at different potential)  
(When DAPmn = 0 and CKPmn = 1, or DAPmn = 1 and CKPmn = 0.)**

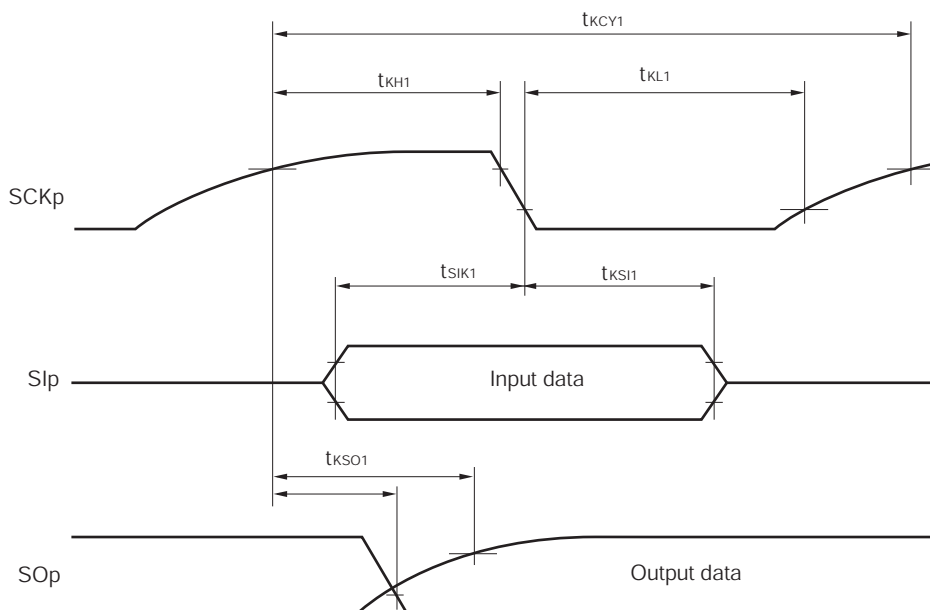

**Remark** p: CSI number (p = 00, 01), m: Unit number (m = 0), n: Channel number (n = 0, 1),  
g: PIM and POM number (g = 1)

**(7) Communication at different potential (1.8 V, 2.5 V, 3 V) (CSI mode) (slave mode, SCKp... external clock input)**  
**(T<sub>A</sub> = -40 to +85°C, 1.8 V ≤ EV<sub>DD</sub> = V<sub>DD</sub> ≤ 5.5 V, V<sub>SS</sub> = EV<sub>SS</sub> = 0 V)** **(1/2)**

| Parameter   | Symbol            | Conditions  |  | HS (high-speed main) mode  |      | LS (low-speed main) mode     |      | LV (low-voltage main) mode   |      | Unit                         |  |    |
|---|-------------------|---|--|--|------|------------------------------|------|------------------------------|------|------------------------------|--|----|
|   |                   |   |  | MIN.   | MAX. | MIN.                         | MAX. | MIN.                         | MAX. |                              |  |    |
| SCKp cycle time <sup>Note 1</sup>   | t <sub>KCY2</sub> | 4.0 V ≤ EV <sub>DD</sub> ≤ 5.5 V,<br>2.7 V ≤ V <sub>b</sub> ≤ 4.0 V                   | 20 MHz < f <sub>MCK</sub> ≤ 24 MHz     | 12/f <sub>MCK</sub>  |      |                              |      |                              |      | ns                           |  |    |
|   |                   |   | 8 MHz < f <sub>MCK</sub> ≤ 20 MHz      | 10/f <sub>MCK</sub>  |      |                              |      |                              |      | ns                           |  |    |
|   |                   |   | 4 MHz < f <sub>MCK</sub> ≤ 8 MHz       | 8/f <sub>MCK</sub>   |      | 16/f <sub>MCK</sub>          |      |                              |      | ns                           |  |    |
|   |                   |   | f <sub>MCK</sub> ≤ 4 MHz               | 6/f <sub>MCK</sub>   |      | 10/f <sub>MCK</sub>          |      | 10/f <sub>MCK</sub>          |      | ns                           |  |    |
|   |                   | 2.7 V ≤ EV <sub>DD</sub> < 4.0 V,<br>2.3 V ≤ V <sub>b</sub> ≤ 2.7 V                   | 20 MHz < f <sub>MCK</sub> ≤ 24 MHz     | 16/f <sub>MCK</sub>  |      |                              |      |                              |      | ns                           |  |    |
|   |                   |   | 16 MHz < f <sub>MCK</sub> ≤ 20 MHz     | 14/f <sub>MCK</sub>  |      |                              |      |                              |      | ns                           |  |    |
|   |                   |   | 8 MHz < f <sub>MCK</sub> ≤ 16 MHz      | 12/f <sub>MCK</sub>  |      |                              |      |                              |      | ns                           |  |    |
|   |                   |   | 4 MHz < f <sub>MCK</sub> ≤ 8 MHz       | 8/f <sub>MCK</sub>   |      | 16/f <sub>MCK</sub>          |      |                              |      | ns                           |  |    |
|   |                   | 2.4 V ≤ EV <sub>DD</sub> < 3.3 V,<br>1.6 V ≤ V <sub>b</sub> ≤ 2.0 V                   | 20 MHz < f <sub>MCK</sub> ≤ 24 MHz     | 36/f <sub>MCK</sub>  |      |                              |      |                              |      | ns                           |  |    |
|   |                   |   | 16 MHz < f <sub>MCK</sub> ≤ 20 MHz     | 32/f <sub>MCK</sub>  |      |                              |      |                              |      | ns                           |  |    |
|   |                   |   | 8 MHz < f <sub>MCK</sub> ≤ 16 MHz      | 26/f <sub>MCK</sub>  |      |                              |      |                              |      | ns                           |  |    |
|   |                   |   | 4 MHz < f <sub>MCK</sub> ≤ 8 MHz       | 16/f <sub>MCK</sub>  |      | 16/f <sub>MCK</sub>          |      |                              |      | ns                           |  |    |
|   |                   | 1.8 V ≤ EV <sub>DD</sub> < 3.3 V,<br>1.6 V ≤ V <sub>b</sub> ≤ 2.0 V <sup>Note 2</sup> | f <sub>MCK</sub> ≤ 4 MHz               | 10/f <sub>MCK</sub>  |      | 10/f <sub>MCK</sub>          |      | 10/f <sub>MCK</sub>          |      | ns                           |  |    |
|   |                   |   | 4 MHz < f <sub>MCK</sub> ≤ 8 MHz       |  |      | 16/f <sub>MCK</sub>          |      |                              |      | ns                           |  |    |
|   |                   | SCKp high-/low-level width  | t <sub>KH2</sub> ,<br>t <sub>KL2</sub> | 4.0 V ≤ EV <sub>DD</sub> ≤ 5.5 V, 2.7 V ≤ V <sub>b</sub> ≤ 4.0 V |      | t <sub>KCY2</sub> /2<br>- 12 |      | t <sub>KCY2</sub> /2<br>- 50 |      | t <sub>KCY2</sub> /2<br>- 50 |  | ns |
|   |                   |   |  | 2.7 V ≤ EV <sub>DD</sub> < 4.0 V, 2.3 V ≤ V <sub>b</sub> ≤ 2.7 V |      | t <sub>KCY2</sub> /2<br>- 18 |      | t <sub>KCY2</sub> /2<br>- 50 |      | t <sub>KCY2</sub> /2<br>- 50 |  | ns |
| 2.4 V ≤ EV <sub>DD</sub> < 3.3 V, 1.6 V ≤ V <sub>b</sub> ≤ 2.0 V                      |                   |   |  | t <sub>KCY2</sub> /2<br>- 50                                     |      | t <sub>KCY2</sub> /2<br>- 50 |      | t <sub>KCY2</sub> /2<br>- 50 |      | ns                           |  |    |
| 1.8 V ≤ EV <sub>DD</sub> < 3.3 V,<br>1.6 V ≤ V <sub>b</sub> ≤ 2.0 V <sup>Note 2</sup> |                   |   |  |  |      | t <sub>KCY2</sub> /2<br>- 50 |      | t <sub>KCY2</sub> /2<br>- 50 |      | ns                           |  |    |
| Slp setup time<br>(to SCKp↑) <sup>Note 3</sup>  | t <sub>SIK2</sub> | 4.0 V ≤ EV <sub>DD</sub> < 5.5 V, 2.7 V ≤ V <sub>b</sub> ≤ 4.0 V                      |  | 1/f <sub>MCK</sub> +<br>20                                       |      | 1/f <sub>MCK</sub> +<br>30   |      | 1/f <sub>MCK</sub> +<br>30   |      | ns                           |  |    |
|   |                   | 2.7 V ≤ EV <sub>DD</sub> < 4.0 V, 2.3 V ≤ V <sub>b</sub> ≤ 2.7 V                      |  | 1/f <sub>MCK</sub> +<br>20                                       |      | 1/f <sub>MCK</sub> +<br>30   |      | 1/f <sub>MCK</sub> +<br>30   |      | ns                           |  |    |
|   |                   | 2.4 V ≤ EV <sub>DD</sub> < 3.3 V, 1.6 V ≤ V <sub>b</sub> ≤ 2.0 V                      |  | 1/f <sub>MCK</sub> +<br>30                                       |      | 1/f <sub>MCK</sub> +<br>30   |      | 1/f <sub>MCK</sub> +<br>30   |      | ns                           |  |    |
|   |                   | 1.8 V ≤ EV <sub>DD</sub> < 3.3 V,<br>1.6 V ≤ V <sub>b</sub> ≤ 2.0 V <sup>Note 2</sup> |  |  |      | 1/f <sub>MCK</sub> +<br>30   |      | 1/f <sub>MCK</sub> +<br>30   |      | ns                           |  |    |
| Slp hold time<br>(from SCKp↑) <sup>Note 4</sup>                                       | t <sub>KS2</sub>  | 4.0 V ≤ EV <sub>DD</sub> < 5.5 V, 2.7 V ≤ V <sub>b</sub> ≤ 4.0 V                      |  | 1/f <sub>MCK</sub> +<br>31                                       |      | 1/f <sub>MCK</sub> +<br>31   |      | 1/f <sub>MCK</sub> +<br>31   |      | ns                           |  |    |
|   |                   | 2.7 V ≤ EV <sub>DD</sub> < 4.0 V, 2.3 V ≤ V <sub>b</sub> ≤ 2.7 V                      |  | 1/f <sub>MCK</sub> +<br>31                                       |      | 1/f <sub>MCK</sub> +<br>31   |      | 1/f <sub>MCK</sub> +<br>31   |      | ns                           |  |    |
|   |                   | 2.4 V ≤ EV <sub>DD</sub> < 3.3 V, 1.6 V ≤ V <sub>b</sub> ≤ 2.0 V                      |  | 1/f <sub>MCK</sub> +<br>31                                       |      | 1/f <sub>MCK</sub> +<br>31   |      | 1/f <sub>MCK</sub> +<br>31   |      | ns                           |  |    |
|   |                   | 1.8 V ≤ EV <sub>DD</sub> < 3.3 V,<br>1.6 V ≤ V <sub>b</sub> ≤ 2.0 V <sup>Note 2</sup> |  |  |      | 1/f <sub>MCK</sub> +<br>31   |      | 1/f <sub>MCK</sub> +<br>31   |      | ns                           |  |    |

(Notes, Caution and Remarks are listed on the next page.)



**(7) Communication at different potential (1.8 V, 2.5 V, 3 V) (CSI mode) (slave mode, SCKp... external clock input)**  
**(T<sub>A</sub> = -40 to +85°C, 1.8 V ≤ EV<sub>DD</sub> = V<sub>DD</sub> ≤ 5.5 V, V<sub>SS</sub> = EV<sub>SS</sub> = 0 V)** **(2/2)**

| Parameter   | Symbol            | Conditions   | HS (high-speed main) mode |                          | LS (low-speed main) mode |                          | LV (low-voltage main) mode |                          | Unit |
|---|-------------------|--|---------------------------|--------------------------|--------------------------|--------------------------|----------------------------|--------------------------|------|
|   |                   |  | MIN.                      | MAX.                     | MIN.                     | MAX.                     | MIN.                       | MAX.                     |      |
| Delay time from SCKp↓ to SOp output <sup>Note 5</sup> | t <sub>KS02</sub> | 4.0 V ≤ EV <sub>DD</sub> ≤ 5.5 V, 2.7 V ≤ V <sub>b</sub> ≤ 4.0 V, C <sub>b</sub> = 30 pF, R <sub>b</sub> = 1.4 kΩ                    |                           | 2/f <sub>MCK</sub> + 120 |                          | 2/f <sub>MCK</sub> + 573 |                            | 2/f <sub>MCK</sub> + 573 | ns   |
|   |                   | 2.7 V ≤ EV <sub>DD</sub> < 4.0 V, 2.3 V ≤ V <sub>b</sub> ≤ 2.7 V, C <sub>b</sub> = 30 pF, R <sub>b</sub> = 2.7 kΩ                    |                           | 2/f <sub>MCK</sub> + 214 |                          | 2/f <sub>MCK</sub> + 573 |                            | 2/f <sub>MCK</sub> + 573 | ns   |
|   |                   | 2.4 V ≤ EV <sub>DD</sub> < 3.3 V, 1.6 V ≤ V <sub>b</sub> ≤ 2.0 V, C <sub>b</sub> = 30 pF, R <sub>b</sub> = 5.5 kΩ                    |                           | 2/f <sub>MCK</sub> + 573 |                          | 2/f <sub>MCK</sub> + 573 |                            | 2/f <sub>MCK</sub> + 573 | ns   |
|   |                   | 1.8 V ≤ EV <sub>DD</sub> < 3.3 V, 1.6 V ≤ V <sub>b</sub> ≤ 2.0 V <sup>Note 2</sup> , C <sub>b</sub> = 30 pF, R <sub>b</sub> = 5.5 kΩ |                           |                          |                          | 2/f <sub>MCK</sub> + 573 |                            | 2/f <sub>MCK</sub> + 573 | ns   |

**Notes 1.** Transfer rate in the SNOOZE mode : MAX. 1 Mbps

**2.** Use it with EV<sub>DD</sub> ≥ V<sub>b</sub>.

**3.** When DAP<sub>mn</sub> = 0 and CKP<sub>mn</sub> = 0, or DAP<sub>mn</sub> = 1 and CKP<sub>mn</sub> = 1. The SIp setup time becomes “to SCKp↓” when DAP<sub>mn</sub> = 0 and CKP<sub>mn</sub> = 1, or DAP<sub>mn</sub> = 1 and CKP<sub>mn</sub> = 0.

**4.** When DAP<sub>mn</sub> = 0 and CKP<sub>mn</sub> = 0, or DAP<sub>mn</sub> = 1 and CKP<sub>mn</sub> = 1. The SIp hold time becomes “from SCKp↓” when DAP<sub>mn</sub> = 0 and CKP<sub>mn</sub> = 1, or DAP<sub>mn</sub> = 1 and CKP<sub>mn</sub> = 0.

**5.** When DAP<sub>mn</sub> = 0 and CKP<sub>mn</sub> = 0, or DAP<sub>mn</sub> = 1 and CKP<sub>mn</sub> = 1. The delay time to SOp output becomes “from SCKp↑” when DAP<sub>mn</sub> = 0 and CKP<sub>mn</sub> = 1, or DAP<sub>mn</sub> = 1 and CKP<sub>mn</sub> = 0.

**Caution** Select the TTL input buffer for the SIp pin and SCKp pin and the N-ch open drain output (V<sub>DD</sub> tolerance (32-pin to 52-pin products)/EV<sub>DD</sub> tolerance (64-pin products)) mode for the SOp pin by using port input mode register g (PIMg) and port output mode register g (POMg). For V<sub>IH</sub> and V<sub>IL</sub>, see the DC characteristics with TTL input buffer selected.

**CSI mode connection diagram (during communication at different potential)**

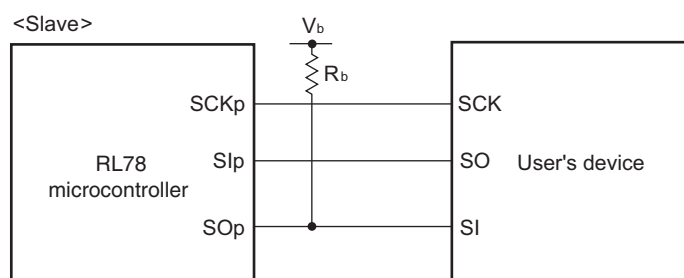

**Remarks 1.** R<sub>b</sub>[Ω]: Communication line (SO<sub>p</sub>) pull-up resistance, C<sub>b</sub>[F]: Communication line (SO<sub>p</sub>) load capacitance, V<sub>b</sub>[V]: Communication line voltage

**2.** p: CSI number (p = 00, 01), m: Unit number (m = 0), n: Channel number (n = 0, 1), g: PIM and POM number (g = 1)

**3.** f<sub>MCK</sub>: Serial array unit operation clock frequency  
 (Operation clock to be set by the serial clock select register m (SPSm) and the CKSmn bit of serial mode register mn (SMRmn). m: Unit number, n: Channel number (mn = 00, 01))

**CSI mode serial transfer timing (slave mode) (during communication at different potential)  
(When DAPmn = 0 and CKPmn = 0, or DAPmn = 1 and CKPmn = 1.)**

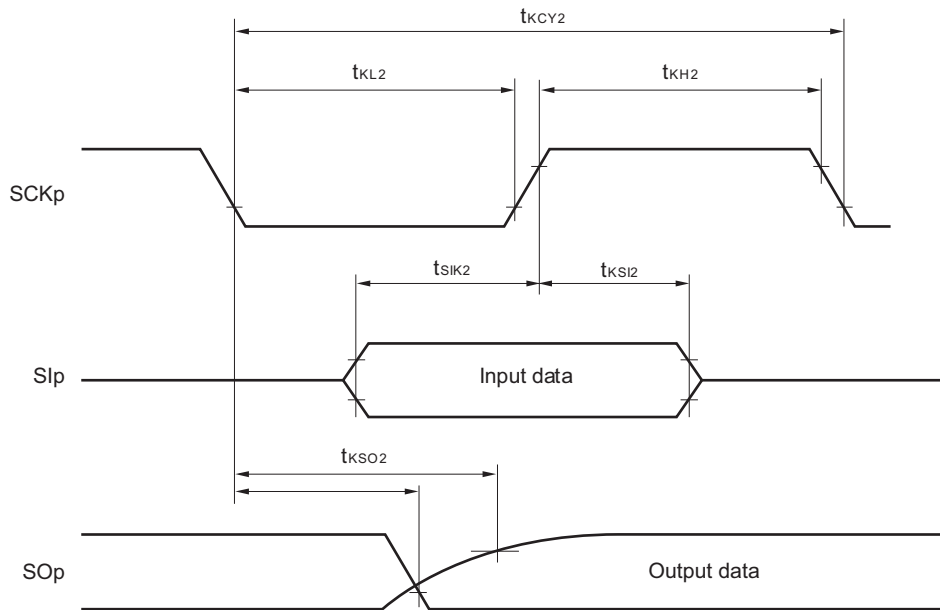

**CSI mode serial transfer timing (slave mode) (during communication at different potential)  
(When DAPmn = 0 and CKPmn = 1, or DAPmn = 1 and CKPmn = 0.)**

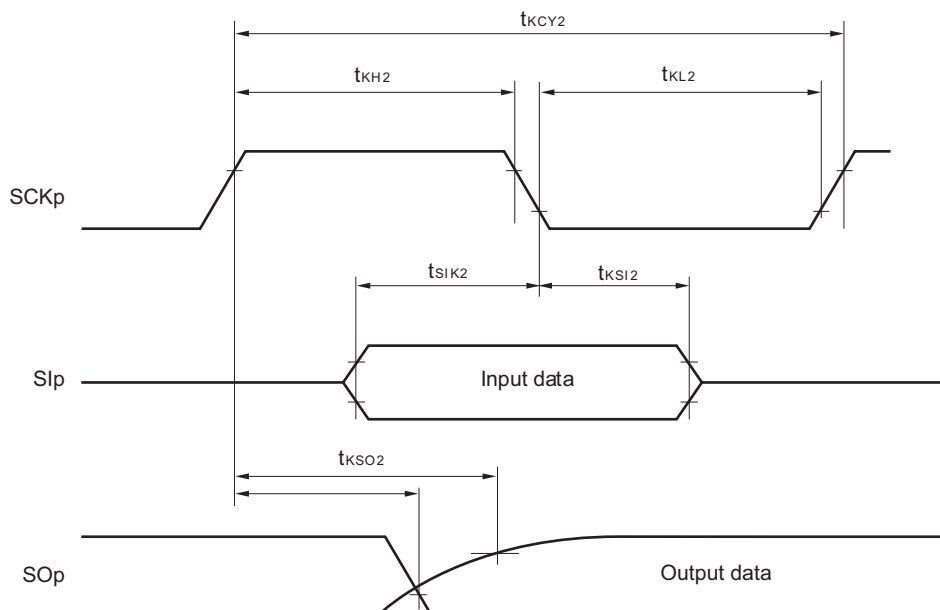

**Remark** p: CSI number (p = 00, 01), m: Unit number (m = 0), n: Channel number (n = 0, 1),  
g: PIM and POM number (g = 1)

## 2.5.2 Serial interface IICA

(1) I<sup>2</sup>C standard mode(T<sub>A</sub> = -40 to +85°C, 1.6 V ≤ EV<sub>DD</sub> = V<sub>DD</sub> ≤ 5.5 V, V<sub>SS</sub> = EV<sub>SS</sub> = 0 V)

| Parameter                                       | Symbol              | Conditions                                 | HS (high-speed main) Mode        |      | LS (low-speed main) Mode |      | LV (low-voltage main) Mode |      | Unit |     |
|---|---------------------|--|----------------------------------|------|--------------------------|------|----------------------------|------|------|-----|
|   |                     |  | MIN.                             | MAX. | MIN.                     | MIN. | MAX.                       | MIN. |      |     |
| SCLA0 clock frequency                           | f <sub>SCL</sub>    | Standard mode:<br>f <sub>CLK</sub> ≥ 1 MHz | 2.7 V ≤ EV <sub>DD</sub> ≤ 5.5 V | 0    | 100                      | 0    | 100                        | 0    | 100  | kHz |
|   |                     |  | 2.4 V ≤ EV <sub>DD</sub> ≤ 5.5 V | 0    | 100                      | 0    | 100                        | 0    | 100  |     |
|   |                     |  | 1.8 V ≤ EV <sub>DD</sub> ≤ 5.5 V |      |                          | 0    | 100                        | 0    | 100  |     |
|   |                     |  | 1.6 V ≤ EV <sub>DD</sub> ≤ 5.5 V |      |                          |      |                            | 0    | 100  |     |
| Setup time of restart condition                 | t <sub>SU:STA</sub> | 2.7 V ≤ EV <sub>DD</sub> ≤ 5.5 V           | 4.7                              |      | 4.7                      |      | 4.7                        |      | μs   |     |
|   |                     | 2.4 V ≤ EV <sub>DD</sub> ≤ 5.5 V           | 4.7                              |      | 4.7                      |      | 4.7                        |      |      |     |
|   |                     | 1.8 V ≤ EV <sub>DD</sub> ≤ 5.5 V           |                                  |      | 4.7                      |      | 4.7                        |      |      |     |
|   |                     | 1.6 V ≤ EV <sub>DD</sub> ≤ 5.5 V           |                                  |      |                          |      | 4.7                        |      |      |     |
| Hold time <sup>Note 1</sup>                     | t <sub>HD:STA</sub> | 2.7 V ≤ EV <sub>DD</sub> ≤ 5.5 V           | 4.0                              |      | 4.0                      |      | 4.0                        |      | μs   |     |
|   |                     | 2.4 V ≤ EV <sub>DD</sub> ≤ 5.5 V           | 4.0                              |      | 4.0                      |      | 4.0                        |      |      |     |
|   |                     | 1.8 V ≤ EV <sub>DD</sub> ≤ 5.5 V           |                                  |      | 4.0                      |      | 4.0                        |      |      |     |
|   |                     | 1.6 V ≤ EV <sub>DD</sub> ≤ 5.5 V           |                                  |      |                          |      | 4.0                        |      |      |     |
| Hold time when SCLA0 = "L"                      | t <sub>LOW</sub>    | 2.7 V ≤ EV <sub>DD</sub> ≤ 5.5 V           | 4.7                              |      | 4.7                      |      | 4.7                        |      | μs   |     |
|   |                     | 2.4 V ≤ EV <sub>DD</sub> ≤ 5.5 V           | 4.7                              |      | 4.7                      |      | 4.7                        |      |      |     |
|   |                     | 1.8 V ≤ EV <sub>DD</sub> ≤ 5.5 V           |                                  |      | 4.7                      |      | 4.7                        |      |      |     |
|   |                     | 1.6 V ≤ EV <sub>DD</sub> ≤ 5.5 V           |                                  |      |                          |      | 4.7                        |      |      |     |
| Hold time when SCLA0 = "H"                      | t <sub>HIGH</sub>   | 2.7 V ≤ EV <sub>DD</sub> ≤ 5.5 V           | 4.0                              |      | 4.0                      |      | 4.0                        |      | μs   |     |
|   |                     | 2.4 V ≤ EV <sub>DD</sub> ≤ 5.5 V           | 4.0                              |      | 4.0                      |      | 4.0                        |      |      |     |
|   |                     | 1.8 V ≤ EV <sub>DD</sub> ≤ 5.5 V           |                                  |      | 4.0                      |      | 4.0                        |      |      |     |
|   |                     | 1.6 V ≤ EV <sub>DD</sub> ≤ 5.5 V           |                                  |      |                          |      | 4.0                        |      |      |     |
| Data setup time (reception)                     | t <sub>SU:DAT</sub> | 2.7 V ≤ EV <sub>DD</sub> ≤ 5.5 V           | 250                              |      | 250                      |      | 250                        |      | ns   |     |
|   |                     | 2.4 V ≤ EV <sub>DD</sub> ≤ 5.5 V           | 250                              |      | 250                      |      | 250                        |      |      |     |
|   |                     | 1.8 V ≤ EV <sub>DD</sub> ≤ 5.5 V           |                                  |      | 250                      |      | 250                        |      |      |     |
|   |                     | 1.6 V ≤ EV <sub>DD</sub> ≤ 5.5 V           |                                  |      |                          |      | 250                        |      |      |     |
| Data hold time (transmission) <sup>Note 2</sup> | t <sub>HD:DAT</sub> | 2.7 V ≤ EV <sub>DD</sub> ≤ 5.5 V           | 0                                | 3.45 | 0                        | 3.45 | 0                          | 3.45 | μs   |     |
|   |                     | 2.4 V ≤ EV <sub>DD</sub> ≤ 5.5 V           | 0                                | 3.45 | 0                        | 3.45 | 0                          | 3.45 |      |     |
|   |                     | 1.8 V ≤ EV <sub>DD</sub> ≤ 5.5 V           |                                  |      | 0                        | 3.45 | 0                          | 3.45 |      |     |
|   |                     | 1.6 V ≤ EV <sub>DD</sub> ≤ 5.5 V           |                                  |      |                          |      | 0                          | 3.45 |      |     |
| Setup time of stop condition                    | t <sub>SU:STO</sub> | 2.7 V ≤ EV <sub>DD</sub> ≤ 5.5 V           | 4.0                              |      | 4.0                      |      | 4.0                        |      | μs   |     |
|   |                     | 2.4 V ≤ EV <sub>DD</sub> ≤ 5.5 V           | 4.0                              |      | 4.0                      |      | 4.0                        |      |      |     |
|   |                     | 1.8 V ≤ EV <sub>DD</sub> ≤ 5.5 V           |                                  |      | 4.0                      |      | 4.0                        |      |      |     |
|   |                     | 1.6 V ≤ EV <sub>DD</sub> ≤ 5.5 V           |                                  |      |                          |      | 4.0                        |      |      |     |
| Bus-free time                                   | t <sub>BUF</sub>    | 2.7 V ≤ EV <sub>DD</sub> ≤ 5.5 V           | 4.7                              |      | 4.7                      |      | 4.7                        |      | μs   |     |
|   |                     | 2.4 V ≤ EV <sub>DD</sub> ≤ 5.5 V           | 4.7                              |      | 4.7                      |      | 4.7                        |      |      |     |
|   |                     | 1.8 V ≤ EV <sub>DD</sub> ≤ 5.5 V           |                                  |      | 4.7                      |      | 4.7                        |      |      |     |
|   |                     | 1.6 V ≤ EV <sub>DD</sub> ≤ 5.5 V           |                                  |      |                          |      | 4.7                        |      |      |     |

(Notes and Remark are listed on the next page.)

- Notes**
1. The first clock pulse is generated after this period when the start/restart condition is detected.
  2. The maximum value (MAX.) of t<sub>HD:DAT</sub> is during normal transfer and a wait state is inserted in the  $\overline{\text{ACK}}$  (acknowledge) timing.

**Remark** The maximum value of C<sub>b</sub> (communication line capacitance) and the value of R<sub>b</sub> (communication line pull-up resistor) at that time in each mode are as follows.

Standard mode: C<sub>b</sub> = 400 pF, R<sub>b</sub> = 2.7 kΩ

(2) I<sup>2</sup>C fast mode(T<sub>A</sub> = -40 to +85°C, 1.6 V ≤ EV<sub>DD</sub> = V<sub>DD</sub> ≤ 5.5 V, V<sub>SS</sub> = EV<sub>SS</sub> = 0 V)

| Parameter                                       | Symbol              | Conditions                                  | HS (high-speed main) Mode        |      | LS (low-speed main) Mode |      | LV (low-voltage main) Mode |      | Unit |     |
|---|---------------------|---|----------------------------------|------|--------------------------|------|----------------------------|------|------|-----|
|   |                     |   | MIN.                             | MAX. | MIN.                     | MIN. | MAX.                       | MIN. |      |     |
| SCLA0 clock frequency                           | f <sub>SCL</sub>    | Fast mode:<br>f <sub>CLK</sub> ≥ 3.5<br>MHz | 2.7 V ≤ EV <sub>DD</sub> ≤ 5.5 V | 0    | 400                      | 0    | 400                        | 0    | 400  | kHz |
|   |                     |   | 2.4 V ≤ EV <sub>DD</sub> ≤ 5.5 V | 0    | 400                      | 0    | 400                        | 0    | 400  |     |
|   |                     |   | 1.8 V ≤ EV <sub>DD</sub> ≤ 5.5 V |      |                          | 0    | 400                        | 0    | 400  |     |
| Setup time of restart condition                 | t <sub>SU:STA</sub> | 2.7 V ≤ EV <sub>DD</sub> ≤ 5.5 V            | 0.6                              |      | 0.6                      |      | 0.6                        |      | μs   |     |
|   |                     | 2.4 V ≤ EV <sub>DD</sub> ≤ 5.5 V            | 0.6                              |      | 0.6                      |      | 0.6                        |      |      |     |
|   |                     | 1.8 V ≤ EV <sub>DD</sub> ≤ 5.5 V            |                                  |      | 0.6                      |      | 0.6                        |      |      |     |
| Hold time <sup>Note 1</sup>                     | t <sub>HD:STA</sub> | 2.7 V ≤ EV <sub>DD</sub> ≤ 5.5 V            | 0.6                              |      | 0.6                      |      | 0.6                        |      | μs   |     |
|   |                     | 2.4 V ≤ EV <sub>DD</sub> ≤ 5.5 V            | 0.6                              |      | 0.6                      |      | 0.6                        |      |      |     |
|   |                     | 1.8 V ≤ EV <sub>DD</sub> ≤ 5.5 V            |                                  |      | 0.6                      |      | 0.6                        |      |      |     |
| Hold time when SCLA0 = "L"                      | t <sub>LOW</sub>    | 2.7 V ≤ EV <sub>DD</sub> ≤ 5.5 V            | 1.3                              |      | 1.3                      |      | 1.3                        |      | μs   |     |
|   |                     | 2.4 V ≤ EV <sub>DD</sub> ≤ 5.5 V            | 1.3                              |      | 1.3                      |      | 1.3                        |      |      |     |
|   |                     | 1.8 V ≤ EV <sub>DD</sub> ≤ 5.5 V            |                                  |      | 1.3                      |      | 1.3                        |      |      |     |
| Hold time when SCLA0 = "H"                      | t <sub>HIGH</sub>   | 2.7 V ≤ EV <sub>DD</sub> ≤ 5.5 V            | 0.6                              |      | 0.6                      |      | 0.6                        |      | μs   |     |
|   |                     | 2.4 V ≤ EV <sub>DD</sub> ≤ 5.5 V            | 0.6                              |      | 0.6                      |      | 0.6                        |      |      |     |
|   |                     | 1.8 V ≤ EV <sub>DD</sub> ≤ 5.5 V            |                                  |      | 0.6                      |      | 0.6                        |      |      |     |
| Data setup time (reception)                     | t <sub>SU:DAT</sub> | 2.7 V ≤ EV <sub>DD</sub> ≤ 5.5 V            | 100                              |      | 100                      |      | 100                        |      | ns   |     |
|   |                     | 2.4 V ≤ EV <sub>DD</sub> ≤ 5.5 V            | 100                              |      | 100                      |      | 100                        |      |      |     |
|   |                     | 1.8 V ≤ EV <sub>DD</sub> ≤ 5.5 V            |                                  |      | 100                      |      | 100                        |      |      |     |
| Data hold time (transmission) <sup>Note 2</sup> | t <sub>HD:DAT</sub> | 2.7 V ≤ EV <sub>DD</sub> ≤ 5.5 V            | 0                                | 0.9  | 0                        | 0.9  | 0                          | 0.9  | μs   |     |
|   |                     | 2.4 V ≤ EV <sub>DD</sub> ≤ 5.5 V            | 0                                | 0.9  | 0                        | 0.9  | 0                          | 0.9  |      |     |
|   |                     | 1.8 V ≤ EV <sub>DD</sub> ≤ 5.5 V            |                                  |      | 0                        | 0.9  | 0                          | 0.9  |      |     |
| Setup time of stop condition                    | t <sub>SU:STO</sub> | 2.7 V ≤ EV <sub>DD</sub> ≤ 5.5 V            | 0.6                              |      | 0.6                      |      | 0.6                        |      | μs   |     |
|   |                     | 2.4 V ≤ EV <sub>DD</sub> ≤ 5.5 V            | 0.6                              |      | 0.6                      |      | 0.6                        |      |      |     |
|   |                     | 1.8 V ≤ EV <sub>DD</sub> ≤ 5.5 V            |                                  |      | 0.6                      |      | 0.6                        |      |      |     |
| Bus-free time                                   | t <sub>BUF</sub>    | 2.7 V ≤ EV <sub>DD</sub> ≤ 5.5 V            | 1.3                              |      | 1.3                      |      | 1.3                        |      | μs   |     |
|   |                     | 2.4 V ≤ EV <sub>DD</sub> ≤ 5.5 V            | 1.3                              |      | 1.3                      |      | 1.3                        |      |      |     |
|   |                     | 1.8 V ≤ EV <sub>DD</sub> ≤ 5.5 V            |                                  |      | 1.3                      |      | 1.3                        |      |      |     |

**Notes** 1. The first clock pulse is generated after this period when the start/restart condition is detected.

2. The maximum value (MAX.) of t<sub>HD:DAT</sub> is during normal transfer and a wait state is inserted in the ACK (acknowledge) timing.

**Remark** The maximum value of C<sub>b</sub> (communication line capacitance) and the value of R<sub>b</sub> (communication line pull-up resistor) at that time in each mode are as follows.

Fast mode: C<sub>b</sub> = 320 pF, R<sub>b</sub> = 1.1 kΩ

**(3) I<sup>2</sup>C fast mode plus**

(T<sub>A</sub> = -40 to +85°C, 1.6 V ≤ EV<sub>DD</sub> = V<sub>DD</sub> ≤ 5.5 V, V<sub>SS</sub> = EV<sub>SS</sub> = 0 V)

| Parameter                                       | Symbol              | Conditions   | HS (high-speed main) Mode |      | LS (low-speed main) Mode |      | LV (low-voltage main) Mode |      | Unit |
|---|---------------------|--|---------------------------|------|--------------------------|------|----------------------------|------|------|
|   |                     |  | MIN.                      | MAX. | MIN.                     | MAX. | MIN.                       | MAX. |      |
| SCLA0 clock frequency                           | f <sub>SCL</sub>    | Fast mode plus:<br>f <sub>CLK</sub> ≥ 10 MHz<br>2.7 V ≤ EV <sub>DD</sub> ≤ 5.5 V | 0                         | 1000 | —                        | —    | —                          | —    | kHz  |
| Setup time of restart condition                 | t <sub>SU:STA</sub> | 2.7 V ≤ EV <sub>DD</sub> ≤ 5.5 V   | 0.26                      |      | —                        | —    | —                          | —    | μs   |
| Hold time <sup>Note 1</sup>                     | t <sub>HD:STA</sub> | 2.7 V ≤ EV <sub>DD</sub> ≤ 5.5 V   | 0.26                      |      | —                        | —    | —                          | —    | μs   |
| Hold time when SCLA0 = "L"                      | t <sub>LOW</sub>    | 2.7 V ≤ EV <sub>DD</sub> ≤ 5.5 V   | 0.5                       |      | —                        | —    | —                          | —    | μs   |
| Hold time when SCLA0 = "H"                      | t <sub>HIGH</sub>   | 2.7 V ≤ EV <sub>DD</sub> ≤ 5.5 V   | 0.26                      |      | —                        | —    | —                          | —    | μs   |
| Data setup time (reception)                     | t <sub>SU:DAT</sub> | 2.7 V ≤ EV <sub>DD</sub> ≤ 5.5 V   | 50                        |      | —                        | —    | —                          | —    | μs   |
| Data hold time (transmission) <sup>Note 2</sup> | t <sub>HD:DAT</sub> | 2.7 V ≤ EV <sub>DD</sub> ≤ 5.5 V   | 0                         | 0.45 | —                        | —    | —                          | —    | μs   |
| Setup time of stop condition                    | t <sub>SU:STO</sub> | 2.7 V ≤ EV <sub>DD</sub> ≤ 5.5 V   | 0.26                      |      | —                        | —    | —                          | —    | μs   |
| Bus-free time                                   | t <sub>BUF</sub>    | 2.7 V ≤ EV <sub>DD</sub> ≤ 5.5 V   | 0.5                       |      | —                        | —    | —                          | —    | μs   |

- Notes**
- The first clock pulse is generated after this period when the start/restart condition is detected.
  - The maximum value (MAX.) of t<sub>HD:DAT</sub> is during normal transfer and a wait state is inserted in the ACK (acknowledge) timing.

**Caution** The values in the above table are applied even when bit 2 (PIOR2) in the peripheral I/O redirection register (PIOR) is 1. At this time, the pin characteristics (I<sub>OH1</sub>, I<sub>OL1</sub>, V<sub>OH1</sub>, V<sub>OL1</sub>) must satisfy the values in the redirect destination.

**Remark** The maximum value of C<sub>b</sub> (communication line capacitance) and the value of R<sub>b</sub> (communication line pull-up resistor) at that time in each mode are as follows.

Fast mode plus: C<sub>b</sub> = 120 pF, R<sub>b</sub> = 1.1 kΩ

IICA serial transfer timing

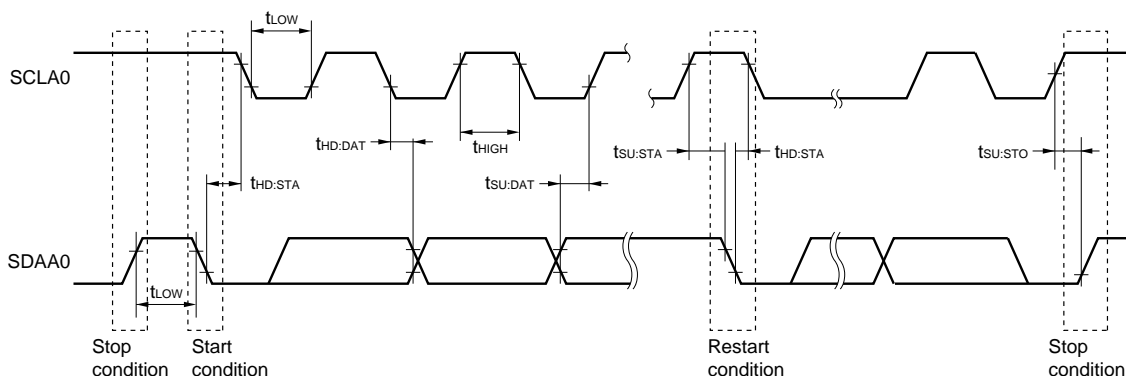

## 2.6 Analog Characteristics

## 2.6.1 A/D converter characteristics

## Classification of A/D converter characteristics

| Input channel   | Reference Voltage  |  |  |
|---|--|--|--|
|   | Reference voltage (+) = AV <sub>REFP</sub><br>Reference voltage (-) = AV <sub>REFM</sub> | Reference voltage (+) = V <sub>DD</sub><br>Reference voltage (-) = V <sub>SS</sub> | Reference voltage (+) = V <sub>BGR</sub><br>Reference voltage (-) = AV <sub>REFM</sub> |
| ANI0, ANI1  | –  | Refer to 2.6.1 (3).  | Refer to 2.6.1 (4).  |
| ANI16 to ANI23  | Refer to 2.6.1 (2).  |  |  |
| Internal reference voltage<br>Temperature sensor output voltage | Refer to 2.6.1 (1).  |  | –  |

(1) When reference voltage (+) = AV<sub>REFP</sub>/ANI0 (ADREFP1 = 0, ADREFP0 = 1), reference voltage (-) = AV<sub>REFM</sub>/ANI1 (ADREFM = 1), target pin : internal reference voltage, and temperature sensor output voltage

(T<sub>A</sub> = -40 to +85°C, 2.4 V ≤ EV<sub>DD</sub> = V<sub>DD</sub> ≤ 5.5 V, 1.6 V ≤ AV<sub>REFP</sub> ≤ V<sub>DD</sub> ≤ 5.5 V, V<sub>SS</sub> = EV<sub>SS</sub> = 0 V, Reference voltage (+) = AV<sub>REFP</sub>, Reference voltage (-) = AV<sub>REFM</sub> = 0 V)

| Parameter   | Symbol            | Conditions  | MIN.   | TYP.   | MAX.                                  | Unit  |      |
|---|-------------------|---|--|--------|---------------------------------------|-------|------|
| Resolution  | RES               |   | 8  |        | 10                                    | bit   |      |
| Overall error <sup>Note 1</sup>                   | AINL              | 10-bit resolution<br>AV <sub>REFP</sub> = V <sub>DD</sub> <sup>Note 3</sup>   | 1.8 V ≤ V <sub>DD</sub> ≤ 5.5 V                      |        | 1.2                                   | ±3.5  | LSB  |
|   |                   |   | 1.6 V ≤ V <sub>DD</sub> ≤ 5.5 V <sup>Note 4</sup>    |        | 1.2                                   | ±7.0  | LSB  |
| Conversion time                                   | t <sub>CONV</sub> | 10-bit resolution<br>Target pin: Internal reference<br>voltage, and temperature<br>sensor output voltage (HS<br>(high-speed main) mode) | 3.6 V ≤ V <sub>DD</sub> ≤ 5.5 V                      | 2.375  |                                       | 39    | μs   |
|   |                   |   | 2.7 V ≤ V <sub>DD</sub> ≤ 5.5 V                      | 3.5625 |                                       | 39    | μs   |
|   |                   |   | 2.4 V ≤ V <sub>DD</sub> ≤ 5.5 V                      | 17     |                                       | 39    | μs   |
| Zero-scale error <sup>Notes 1, 2</sup>            | E <sub>ZS</sub>   | 10-bit resolution<br>AV <sub>REFP</sub> = V <sub>DD</sub> <sup>Note 3</sup>   | 1.8 V ≤ AV <sub>REFP</sub> ≤ 5.5 V                   |        |                                       | ±0.25 | %FSR |
|   |                   |   | 1.6 V ≤ AV <sub>REFP</sub> ≤ 5.5 V <sup>Note 4</sup> |        |                                       | ±0.50 | %FSR |
| Full-scale error <sup>Notes 1, 2</sup>            | E <sub>FS</sub>   | 10-bit resolution<br>AV <sub>REFP</sub> = V <sub>DD</sub> <sup>Note 3</sup>   | 1.8 V ≤ AV <sub>REFP</sub> ≤ 5.5 V                   |        |                                       | ±0.25 | %FSR |
|   |                   |   | 1.6 V ≤ AV <sub>REFP</sub> ≤ 5.5 V <sup>Note 4</sup> |        |                                       | ±0.50 | %FSR |
| Integral linearity<br>error <sup>Note 1</sup>     | ILE               | 10-bit resolution<br>AV <sub>REFP</sub> = V <sub>DD</sub> <sup>Note 3</sup>   | 1.8 V ≤ V <sub>DD</sub> ≤ 5.5 V                      |        |                                       | ±2.5  | LSB  |
|   |                   |   | 1.6 V ≤ V <sub>DD</sub> ≤ 5.5 V <sup>Note 4</sup>    |        |                                       | ±5.0  | LSB  |
| Differential linearity<br>error <sup>Note 1</sup> | DLE               | 10-bit resolution<br>AV <sub>REFP</sub> = V <sub>DD</sub> <sup>Note 3</sup>   | 1.8 V ≤ V <sub>DD</sub> ≤ 5.5 V                      |        |                                       | ±1.5  | LSB  |
|   |                   |   | 1.6 V ≤ V <sub>DD</sub> ≤ 5.5 V <sup>Note 4</sup>    |        |                                       | ±2.0  | LSB  |
| Analog input voltage                              | V <sub>AIN</sub>  | Internal reference voltage<br>(2.4 V ≤ V <sub>DD</sub> ≤ 5.5 V, HS (high-speed main) mode)  |  |        | V <sub>BGR</sub> <sup>Note 5</sup>    | V     |      |
|   | V <sub>BGR</sub>  | Temperature sensor output voltage<br>(2.4 V ≤ V <sub>DD</sub> ≤ 5.5 V, HS (high-speed main) mode)                                       |  |        | V <sub>TMPS25</sub> <sup>Note 5</sup> | V     |      |

**Notes** 1. Excludes quantization error (±1/2 LSB).

2. This value is indicated as a ratio (%FSR) to the full-scale value.

3. When AV<sub>REFP</sub> < V<sub>DD</sub>, the MAX. values are as follows.

Overall error: Add ±1.0 LSB to the MAX. value when AV<sub>REFP</sub> = V<sub>DD</sub>.

Zero-scale error/Full-scale error: Add ±0.05%FSR to the MAX. value when AV<sub>REFP</sub> = V<sub>DD</sub>.

Integral linearity error/Differential linearity error: Add ±0.5 LSB to the MAX. value when AV<sub>REFP</sub> = V<sub>DD</sub>.

4. Values when the conversion time is set to 57 μs (min.) and 95 μs (max.).

5. Refer to 2.6.2 Temperature sensor/internal reference voltage characteristics.

(2) When reference voltage (+) = AV<sub>REFP</sub>/ANI0 (ADREFP1 = 0, ADREFP0 = 1), reference voltage (-) = AV<sub>REFM</sub>/ANI1 (ADREFM = 1), target pin : ANI16 to ANI23

(T<sub>A</sub> = -40 to +85°C, 1.6 V ≤ EV<sub>DD</sub> = V<sub>DD</sub> ≤ 5.5 V, 1.6 V ≤ AV<sub>REFP</sub> ≤ V<sub>DD</sub> ≤ 5.5 V, V<sub>SS</sub> = EV<sub>SS</sub> = 0 V, Reference voltage (+) = AV<sub>REFP</sub>, Reference voltage (-) = AV<sub>REFM</sub> = 0 V)

| Parameter   | Symbol            | Conditions   | MIN.  | TYP.  | MAX.  | Unit  |      |
|---|-------------------|--|---|-------|---|-------|------|
| Resolution  | RES               |  | 8   |       | 10  | bit   |      |
| Overall error <sup>Note 1</sup>                   | AINL              | 10-bit resolution<br>AV <sub>REFP</sub> = EV <sub>DD</sub> = V <sub>DD</sub> <sup>Note 3</sup> | 1.8 V ≤ AV <sub>REFP</sub> ≤ 5.5 V                      |       | 1.2   | ±5.0  | LSB  |
|   |                   |  | 1.6 V ≤ AV <sub>REFP</sub> ≤ 5.5 V<br><sup>Note 4</sup> |       | 1.2   | ±8.5  | LSB  |
| Conversion time                                   | t <sub>CONV</sub> | 10-bit resolution<br>AV <sub>REFP</sub> = EV <sub>DD</sub> = V <sub>DD</sub> <sup>Note 3</sup> | 3.6 V ≤ V <sub>DD</sub> ≤ 5.5 V                         | 2.125 |   | 39    | μs   |
|   |                   |  | 2.7 V ≤ V <sub>DD</sub> ≤ 5.5 V                         |       | 3.1875  | 39    | μs   |
|   |                   |  | 1.8 V ≤ V <sub>DD</sub> ≤ 5.5 V                         |       | 17  | 39    | μs   |
|   |                   |  | 1.6 V ≤ V <sub>DD</sub> ≤ 5.5 V                         |       | 57  | 95    | μs   |
| Zero-scale error <sup>Notes 1, 2</sup>            | E <sub>ZS</sub>   | 10-bit resolution<br>AV <sub>REFP</sub> = EV <sub>DD</sub> = V <sub>DD</sub> <sup>Note 3</sup> | 1.8 V ≤ AV <sub>REFP</sub> ≤ 5.5 V                      |       |   | ±0.35 | %FSR |
|   |                   |  | 1.6 V ≤ AV <sub>REFP</sub> ≤ 5.5 V<br><sup>Note 4</sup> |       |   | ±0.60 | %FSR |
| Full-scale error <sup>Notes 1, 2</sup>            | E <sub>FS</sub>   | 10-bit resolution<br>AV <sub>REFP</sub> = EV <sub>DD</sub> = V <sub>DD</sub> <sup>Note 3</sup> | 1.8 V ≤ AV <sub>REFP</sub> ≤ 5.5 V                      |       |   | ±0.35 | %FSR |
|   |                   |  | 1.6 V ≤ AV <sub>REFP</sub> ≤ 5.5 V<br><sup>Note 4</sup> |       |   | ±0.60 | %FSR |
| Integral linearity error <sup>Note 1</sup>        | ILE               | 10-bit resolution<br>AV <sub>REFP</sub> = EV <sub>DD</sub> = V <sub>DD</sub> <sup>Note 3</sup> | 1.8 V ≤ AV <sub>REFP</sub> ≤ 5.5 V                      |       |   | ±3.5  | LSB  |
|   |                   |  | 1.6 V ≤ AV <sub>REFP</sub> ≤ 5.5 V<br><sup>Note 4</sup> |       |   | ±6.0  | LSB  |
| Differential linearity error<br><sup>Note 1</sup> | DLE               | 10-bit resolution<br>AV <sub>REFP</sub> = EV <sub>DD</sub> = V <sub>DD</sub> <sup>Note 3</sup> | 1.8 V ≤ AV <sub>REFP</sub> ≤ 5.5 V                      |       |   | ±2.0  | LSB  |
|   |                   |  | 1.6 V ≤ AV <sub>REFP</sub> ≤ 5.5 V<br><sup>Note 4</sup> |       |   | ±2.5  | LSB  |
| Analog input voltage                              | V <sub>AIN</sub>  |  | 0   |       | AV <sub>REFP</sub><br>and<br>EV <sub>DD</sub> | V     |      |

**Notes** 1. Excludes quantization error (±1/2 LSB).

2. This value is indicated as a ratio (%FSR) to the full-scale value.

3. When AV<sub>REFP</sub> < EV<sub>DD</sub> = V<sub>DD</sub>, the MAX. values are as follows.

Overall error: Add ±4.0 LSB to the MAX. value when AV<sub>REFP</sub> = V<sub>DD</sub>.

Zero-scale error/Full-scale error: Add ±0.20%FSR to the MAX. value when AV<sub>REFP</sub> = V<sub>DD</sub>.

Integral linearity error/Differential linearity error: Add ±2.0 LSB to the MAX. value when AV<sub>REFP</sub> = V<sub>DD</sub>.

4. When the conversion time is set to 57 μs (min.) and 95 μs (max.).



(3) When reference voltage (+) = V<sub>DD</sub> (ADREFP1 = 0, ADREFP0 = 0), reference voltage (-) = V<sub>SS</sub> (ADREFM = 0), target pin : ANI0, ANI1, ANI16 to ANI23, internal reference voltage, and temperature sensor output voltage

(T<sub>A</sub> = -40 to +85°C, 1.6 V ≤ EV<sub>DD</sub> = V<sub>DD</sub> ≤ 5.5 V, V<sub>SS</sub> = EV<sub>SS</sub> = 0 V, Reference voltage (+) = V<sub>DD</sub>, Reference voltage (-) = V<sub>SS</sub>)

| Parameter                                      | Symbol            | Conditions   | MIN.   | TYP.   | MAX.                                  | Unit  |      |
|--|-------------------|--|--|--------|---------------------------------------|-------|------|
| Resolution                                     | RES               |  | 8  |        | 10                                    | bit   |      |
| Overall error <sup>Note 1</sup>                | AINL              | 10-bit resolution  | 1.8 V ≤ V <sub>DD</sub> ≤ 5.5 V                      |        | 1.2                                   | ±7.0  | LSB  |
|  |                   |  | 1.6 V ≤ V <sub>DD</sub> ≤ 5.5 V<br><sup>Note 3</sup> |        | 1.2                                   | ±10.5 | LSB  |
| Conversion time                                | t <sub>CONV</sub> | 10-bit resolution  | 3.6 V ≤ V <sub>DD</sub> ≤ 5.5 V                      | 2.125  |                                       | 39    | μs   |
|  |                   |  | 2.7 V ≤ V <sub>DD</sub> ≤ 5.5 V                      | 3.1875 |                                       | 39    | μs   |
|  |                   |  | 1.8 V ≤ V <sub>DD</sub> ≤ 5.5 V                      | 17     |                                       | 39    | μs   |
|  |                   |  | 1.6 V ≤ V <sub>DD</sub> ≤ 5.5 V                      | 57     |                                       | 95    | μs   |
|  |                   | 10-bit resolution<br>Target pin: Internal<br>reference voltage, and<br>temperature sensor output<br>voltage (HS (high-speed<br>main) mode) | 3.6 V ≤ V <sub>DD</sub> ≤ 5.5 V                      | 2.375  |                                       | 39    | μs   |
|  |                   |  | 2.7 V ≤ V <sub>DD</sub> ≤ 5.5 V                      | 3.5625 |                                       | 39    | μs   |
| Zero-scale error <sup>Notes 1, 2</sup>         | E <sub>ZS</sub>   | 10-bit resolution  | 1.8 V ≤ V <sub>DD</sub> ≤ 5.5 V                      |        |                                       | ±0.60 | %FSR |
|  |                   |  | 1.6 V ≤ V <sub>DD</sub> ≤ 5.5 V<br><sup>Note 3</sup> |        |                                       | ±0.85 | %FSR |
| Full-scale error <sup>Notes 1, 2</sup>         | E <sub>FS</sub>   | 10-bit resolution  | 1.8 V ≤ V <sub>DD</sub> ≤ 5.5 V                      |        |                                       | ±0.60 | %FSR |
|  |                   |  | 1.6 V ≤ V <sub>DD</sub> ≤ 5.5 V<br><sup>Note 3</sup> |        |                                       | ±0.85 | %FSR |
| Integral linearity error <sup>Note 1</sup>     | ILE               | 10-bit resolution  | 1.8 V ≤ V <sub>DD</sub> ≤ 5.5 V                      |        |                                       | ±4.0  | LSB  |
|  |                   |  | 1.6 V ≤ V <sub>DD</sub> ≤ 5.5 V<br><sup>Note 3</sup> |        |                                       | ±6.5  | LSB  |
| Differential linearity error <sup>Note 1</sup> | DLE               | 10-bit resolution  | 1.8 V ≤ V <sub>DD</sub> ≤ 5.5 V                      |        |                                       | ±2.0  | LSB  |
|  |                   |  | 1.6 V ≤ V <sub>DD</sub> ≤ 5.5 V<br><sup>Note 3</sup> |        |                                       | ±2.5  | LSB  |
| Analog input voltage                           | V <sub>AIN</sub>  | ANI0, ANI1   | 0  |        | V <sub>DD</sub>                       | V     |      |
|  |                   | ANI16 to ANI23   | 0  |        | EV <sub>DD</sub>                      | V     |      |
|  |                   | Internal reference voltage<br>(2.4 V ≤ V <sub>DD</sub> ≤ 5.5 V, HS (high-speed main) mode)   |  |        | V <sub>BGR</sub> <sup>Note 4</sup>    | V     |      |
|  |                   | Temperature sensor output voltage<br>(2.4 V ≤ V <sub>DD</sub> ≤ 5.5 V, HS (high-speed main) mode)  |  |        | V <sub>TMPS25</sub> <sup>Note 4</sup> | V     |      |

**Notes** 1. Excludes quantization error (±1/2 LSB).

2. This value is indicated as a ratio (%FSR) to the full-scale value.

3. When the conversion time is set to 57 μs (min.) and 95 μs (max.).

4. Refer to 2.6.2 Temperature sensor/internal reference voltage characteristics.

(4) When reference voltage (+) = Internal reference voltage (ADREFP1 = 1, ADREFP0 = 0), reference voltage (-) = AV<sub>REFM</sub>/ANI1 (ADREFM = 1), target pin : ANI0, ANI16 to ANI23

(T<sub>A</sub> = -40 to +85°C, 2.4 V ≤ EV<sub>DD</sub> = V<sub>DD</sub> ≤ 5.5 V, V<sub>SS</sub> = EV<sub>SS</sub> = 0 V, Reference voltage (+) = V<sub>BGR</sub> <sup>Note 3</sup>, Reference voltage (-) = AV<sub>REFM</sub> <sup>Note 4</sup> = 0 V, HS (high-speed main) mode)

| Parameter                                      | Symbol            | Conditions       |                                 | MIN. | TYP. | MAX.                               | Unit |
|--|-------------------|------------------|---------------------------------|------|------|------------------------------------|------|
| Resolution                                     | RES               |                  |                                 | 8    |      |                                    | bit  |
| Conversion time                                | t <sub>CONV</sub> | 8-bit resolution | 2.4 V ≤ V <sub>DD</sub> ≤ 5.5 V | 17   |      | 39                                 | μs   |
| Zero-scale error <sup>Notes 1, 2</sup>         | E <sub>ZS</sub>   | 8-bit resolution | 2.4 V ≤ V <sub>DD</sub> ≤ 5.5 V |      |      | ±0.60                              | %FSR |
| Integral linearity error <sup>Note 1</sup>     | ILE               | 8-bit resolution | 2.4 V ≤ V <sub>DD</sub> ≤ 5.5 V |      |      | ±2.0                               | LSB  |
| Differential linearity error <sup>Note 1</sup> | DLE               | 8-bit resolution | 2.4 V ≤ V <sub>DD</sub> ≤ 5.5 V |      |      | ±1.0                               | LSB  |
| Analog input voltage                           | V <sub>AIN</sub>  |                  |                                 | 0    |      | V <sub>BGR</sub> <sup>Note 3</sup> | V    |

**Notes** 1. Excludes quantization error (±1/2 LSB).

2. This value is indicated as a ratio (%FSR) to the full-scale value.

3. Refer to **2.6.2 Temperature sensor/internal reference voltage characteristics**.

4. When reference voltage (-) = V<sub>SS</sub>, the MAX. values are as follows.

Zero-scale error: Add ±0.35%FSR to the MAX. value when reference voltage (-) = AV<sub>REFM</sub>.

Integral linearity error: Add ±0.5 LSB to the MAX. value when reference voltage (-) = AV<sub>REFM</sub>.

Differential linearity error: Add ±0.2 LSB to the MAX. value when reference voltage (-) = AV<sub>REFM</sub>.

## 2.6.2 Temperature sensor/internal reference voltage characteristics

(T<sub>A</sub> = -40 to +85°C, 2.4 V ≤ EV<sub>DD</sub> = V<sub>DD</sub> ≤ 5.5 V, V<sub>SS</sub> = EV<sub>SS</sub> = 0 V) (HS (high-speed main) mode)

| Parameter                         | Symbol              | Conditions   | MIN. | TYP. | MAX. | Unit  |
|-----------------------------------|---------------------|--|------|------|------|-------|
| Temperature sensor output voltage | V <sub>TMPS25</sub> | Setting ADS register = 80H, T <sub>A</sub> = +25°C |      | 1.05 |      | V     |
| Internal reference voltage        | V <sub>BGR</sub>    | Setting ADS register = 81H                         | 1.38 | 1.45 | 1.5  | V     |
| Temperature coefficient           | F <sub>VTMPS</sub>  | Temperature sensor that depends on the temperature |      | -3.6 |      | mV/°C |
| Operation stabilization wait time | t <sub>AMP</sub>    |  | 5    |      |      | μs    |

## 2.6.3 POR circuit characteristics

**( $T_A = -40$  to  $+85^\circ\text{C}$ ,  $V_{SS} = 0$  V)**

| Parameter                           | Symbol    | Conditions             | MIN. | TYP. | MAX. | Unit          |
|-------------------------------------|-----------|------------------------|------|------|------|---------------|
| Detection voltage                   | $V_{POR}$ | Power supply rise time | 1.47 | 1.51 | 1.55 | V             |
|                                     | $V_{PDR}$ | Power supply fall time | 1.46 | 1.50 | 1.54 | V             |
| Minimum pulse width <sup>Note</sup> | $T_{PW}$  |                        | 300  |      |      | $\mu\text{s}$ |

**Note** Minimum time required for a POR reset when  $V_{DD}$  exceeds below  $V_{PDR}$ . This is also the minimum time required for a POR reset from when  $V_{DD}$  exceeds below 0.7 V to when  $V_{DD}$  exceeds  $V_{POR}$  while STOP mode is entered or the main system clock is stopped through setting bit 0 (HIOSTOP) and bit 7 (MSTOP) in the clock operation status control register (CSC).

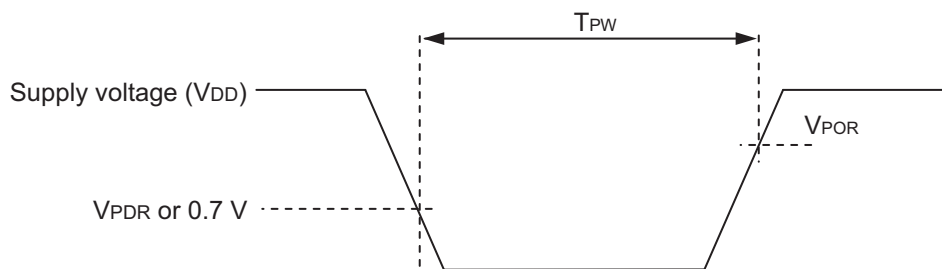

## 2.6.4 LVD circuit characteristics

(T<sub>A</sub> = -40 to +85°C, V<sub>PDR</sub> ≤ E<sub>VDD</sub> = V<sub>DD</sub> ≤ 5.5 V, V<sub>SS</sub> = E<sub>VSS</sub> = 0 V)

| Parameter            |                        | Symbol             | Conditions             | MIN. | TYP. | MAX. | Unit |
|----------------------|------------------------|--------------------|------------------------|------|------|------|------|
| Detection voltage    | Supply voltage level   | V <sub>LVD0</sub>  | Power supply rise time | 3.98 | 4.06 | 4.14 | V    |
|                      |                        |                    | Power supply fall time | 3.90 | 3.98 | 4.06 | V    |
|                      |                        | V <sub>LVD1</sub>  | Power supply rise time | 3.68 | 3.75 | 3.82 | V    |
|                      |                        |                    | Power supply fall time | 3.60 | 3.67 | 3.74 | V    |
|                      |                        | V <sub>LVD2</sub>  | Power supply rise time | 3.07 | 3.13 | 3.19 | V    |
|                      |                        |                    | Power supply fall time | 3.00 | 3.06 | 3.12 | V    |
|                      |                        | V <sub>LVD3</sub>  | Power supply rise time | 2.96 | 3.02 | 3.08 | V    |
|                      |                        |                    | Power supply fall time | 2.90 | 2.96 | 3.02 | V    |
|                      |                        | V <sub>LVD4</sub>  | Power supply rise time | 2.86 | 2.92 | 2.97 | V    |
|                      |                        |                    | Power supply fall time | 2.80 | 2.86 | 2.91 | V    |
|                      |                        | V <sub>LVD5</sub>  | Power supply rise time | 2.76 | 2.81 | 2.87 | V    |
|                      |                        |                    | Power supply fall time | 2.70 | 2.75 | 2.81 | V    |
|                      |                        | V <sub>LVD6</sub>  | Power supply rise time | 2.66 | 2.71 | 2.76 | V    |
|                      |                        |                    | Power supply fall time | 2.60 | 2.65 | 2.70 | V    |
|                      |                        | V <sub>LVD7</sub>  | Power supply rise time | 2.56 | 2.61 | 2.66 | V    |
|                      |                        |                    | Power supply fall time | 2.50 | 2.55 | 2.60 | V    |
|                      |                        | V <sub>LVD8</sub>  | Power supply rise time | 2.45 | 2.50 | 2.55 | V    |
|                      |                        |                    | Power supply fall time | 2.40 | 2.45 | 2.50 | V    |
|                      |                        | V <sub>LVD9</sub>  | Power supply rise time | 2.05 | 2.09 | 2.13 | V    |
|                      |                        |                    | Power supply fall time | 2.00 | 2.04 | 2.08 | V    |
|                      |                        | V <sub>LVD10</sub> | Power supply rise time | 1.94 | 1.98 | 2.02 | V    |
|                      |                        |                    | Power supply fall time | 1.90 | 1.94 | 1.98 | V    |
|                      |                        | V <sub>LVD11</sub> | Power supply rise time | 1.84 | 1.88 | 1.91 | V    |
|                      |                        |                    | Power supply fall time | 1.80 | 1.84 | 1.87 | V    |
| V <sub>LVD12</sub>   | Power supply rise time | 1.74               | 1.77                   | 1.81 | V    |      |      |
|                      | Power supply fall time | 1.70               | 1.73                   | 1.77 | V    |      |      |
| V <sub>LVD13</sub>   | Power supply rise time | 1.64               | 1.67                   | 1.70 | V    |      |      |
|                      | Power supply fall time | 1.60               | 1.63                   | 1.66 | V    |      |      |
| Minimum pulse width  | t <sub>LW</sub>        |                    | 300                    |      |      | μs   |      |
| Detection delay time | t <sub>LD</sub>        |                    |                        |      | 300  | μs   |      |

**LVD Detection Voltage of Interrupt & Reset Mode**(T<sub>A</sub> = -40 to +85°C, V<sub>PDR</sub> ≤ EV<sub>DD</sub> = V<sub>DD</sub> ≤ 5.5 V, V<sub>SS</sub> = EV<sub>SS</sub> = 0 V)

| Parameter                | Symbol              | Conditions   | MIN.                         | TYP. | MAX. | Unit |   |
|--------------------------|---------------------|--|------------------------------|------|------|------|---|
| Interrupt and reset mode | V <sub>LVDA0</sub>  | V <sub>POC2</sub> , V <sub>POC1</sub> , V <sub>POC0</sub> = 0, 0, 0, falling reset voltage | 1.60                         | 1.63 | 1.66 | V    |   |
|                          | V <sub>LVDA1</sub>  | LVIS1, LVIS0 = 1, 0  | Rising release reset voltage | 1.74 | 1.77 | 1.81 | V |
|                          |                     |  | Falling interrupt voltage    | 1.70 | 1.73 | 1.77 | V |
|                          | V <sub>LVDA2</sub>  | LVIS1, LVIS0 = 0, 1  | Rising release reset voltage | 1.84 | 1.88 | 1.91 | V |
|                          |                     |  | Falling interrupt voltage    | 1.80 | 1.84 | 1.87 | V |
|                          | V <sub>LVDA3</sub>  | LVIS1, LVIS0 = 0, 0  | Rising release reset voltage | 2.86 | 2.92 | 2.97 | V |
|                          |                     |  | Falling interrupt voltage    | 2.80 | 2.86 | 2.91 | V |
|                          | V <sub>LVDB1</sub>  | V <sub>POC2</sub> , V <sub>POC1</sub> , V <sub>POC0</sub> = 0, 0, 1, falling reset voltage | 1.80                         | 1.84 | 1.87 | V    |   |
|                          | V <sub>LVDB2</sub>  | LVIS1, LVIS0 = 1, 0  | Rising release reset voltage | 1.94 | 1.98 | 2.02 | V |
|                          |                     |  | Falling interrupt voltage    | 1.90 | 1.94 | 1.98 | V |
|                          | V <sub>LVDB3</sub>  | LVIS1, LVIS0 = 0, 1  | Rising release reset voltage | 2.05 | 2.09 | 2.13 | V |
|                          |                     |  | Falling interrupt voltage    | 2.00 | 2.04 | 2.08 | V |
|                          | V <sub>LVDB4</sub>  | LVIS1, LVIS0 = 0, 0  | Rising release reset voltage | 3.07 | 3.13 | 3.19 | V |
|                          |                     |  | Falling interrupt voltage    | 3.00 | 3.06 | 3.12 | V |
|                          | V <sub>LVDC0</sub>  | V <sub>POC2</sub> , V <sub>POC1</sub> , V <sub>POC0</sub> = 0, 1, 0, falling reset voltage | 2.40                         | 2.45 | 2.50 | V    |   |
|                          | V <sub>LVDC1</sub>  | LVIS1, LVIS0 = 1, 0  | Rising release reset voltage | 2.56 | 2.61 | 2.66 | V |
|                          |                     |  | Falling interrupt voltage    | 2.50 | 2.55 | 2.60 | V |
|                          | V <sub>LVDC2</sub>  | LVIS1, LVIS0 = 0, 1  | Rising release reset voltage | 2.66 | 2.71 | 2.76 | V |
|                          |                     |  | Falling interrupt voltage    | 2.60 | 2.65 | 2.70 | V |
|                          | V <sub>LVDC3</sub>  | LVIS1, LVIS0 = 0, 0  | Rising release reset voltage | 3.68 | 3.75 | 3.82 | V |
|                          |                     |  | Falling interrupt voltage    | 3.60 | 3.67 | 3.74 | V |
|                          | V <sub>LVDD0</sub>  | V <sub>POC2</sub> , V <sub>POC1</sub> , V <sub>POC0</sub> = 0, 1, 1, falling reset voltage | 2.70                         | 2.75 | 2.81 | V    |   |
|                          | V <sub>LVDD1</sub>  | LVIS1, LVIS0 = 1, 0  | Rising release reset voltage | 2.86 | 2.92 | 2.97 | V |
|                          |                     |  | Falling interrupt voltage    | 2.80 | 2.86 | 2.91 | V |
| V <sub>LVDD2</sub>       | LVIS1, LVIS0 = 0, 1 | Rising release reset voltage   | 2.96                         | 3.02 | 3.08 | V    |   |
|                          |                     | Falling interrupt voltage  | 2.90                         | 2.96 | 3.02 | V    |   |
| V <sub>LVDD3</sub>       | LVIS1, LVIS0 = 0, 0 | Rising release reset voltage   | 3.98                         | 4.06 | 4.14 | V    |   |
|                          |                     | Falling interrupt voltage  | 3.90                         | 3.98 | 4.06 | V    |   |

## 2.6.5 Supply voltage rise time

(T<sub>A</sub> = -40 to +85°C, V<sub>SS</sub> = 0 V)

| Parameter                         | Symbol           | Conditions | MIN. | TYP. | MAX. | Unit |
|-----------------------------------|------------------|------------|------|------|------|------|
| Power supply voltage rising slope | S <sub>VDD</sub> |            |      |      | 54   | V/ms |

**Caution** Make sure to keep the internal reset state by the LVD circuit or an external reset until V<sub>DD</sub> reaches the operating voltage range shown in 2.4 AC Characteristics.

## 2.7 LCD Characteristics

## 2.7.1 Resistance division method

## (1) Static display mode

(T<sub>A</sub> = -40 to +85°C, V<sub>L4</sub> (MIN.) ≤ V<sub>DD</sub> ≤ 5.5 V, V<sub>SS</sub> = 0 V)

| Parameter         | Symbol          | Conditions | MIN. | TYP. | MAX.            | Unit |
|-------------------|-----------------|------------|------|------|-----------------|------|
| LCD drive voltage | V <sub>L4</sub> |            | 2.0  |      | V <sub>DD</sub> | V    |

## (2) 1/2 bias method, 1/4 bias method

(T<sub>A</sub> = -40 to +85°C, V<sub>L4</sub> (MIN.) ≤ V<sub>DD</sub> ≤ 5.5 V, V<sub>SS</sub> = 0 V)

| Parameter         | Symbol          | Conditions | MIN. | TYP. | MAX.            | Unit |
|-------------------|-----------------|------------|------|------|-----------------|------|
| LCD drive voltage | V <sub>L4</sub> |            | 2.7  |      | V <sub>DD</sub> | V    |

## (3) 1/3 bias method

(T<sub>A</sub> = -40 to +85°C, V<sub>L4</sub> (MIN.) ≤ V<sub>DD</sub> ≤ 5.5 V, V<sub>SS</sub> = 0 V)

| Parameter         | Symbol          | Conditions | MIN. | TYP. | MAX.            | Unit |
|-------------------|-----------------|------------|------|------|-----------------|------|
| LCD drive voltage | V <sub>L4</sub> |            | 2.5  |      | V <sub>DD</sub> | V    |

## 2.7.2 Internal voltage boosting method

## (1) 1/3 bias method

(T<sub>A</sub> = -40 to +85°C, 1.8 V ≤ V<sub>DD</sub> ≤ 5.5 V, V<sub>SS</sub> = 0 V)

| Parameter                                      | Symbol             | Conditions                              | MIN.                        | TYP.              | MAX.              | Unit |   |
|--|--------------------|---|-----------------------------|-------------------|-------------------|------|---|
| LCD output voltage variation range             | V <sub>L1</sub>    | C1 to C4 <sup>Note 1</sup><br>= 0.47 μF | VLCD = 04H                  | 0.90              | 1.00              | 1.08 | V |
|  |                    |   | VLCD = 05H                  | 0.95              | 1.05              | 1.13 | V |
|  |                    |   | VLCD = 06H                  | 1.00              | 1.10              | 1.18 | V |
|  |                    |   | VLCD = 07H                  | 1.05              | 1.15              | 1.23 | V |
|  |                    |   | VLCD = 08H                  | 1.10              | 1.20              | 1.28 | V |
|  |                    |   | VLCD = 09H                  | 1.15              | 1.25              | 1.33 | V |
|  |                    |   | VLCD = 0AH                  | 1.20              | 1.30              | 1.38 | V |
|  |                    |   | VLCD = 0BH                  | 1.25              | 1.35              | 1.43 | V |
|  |                    |   | VLCD = 0CH                  | 1.30              | 1.40              | 1.48 | V |
|  |                    |   | VLCD = 0DH                  | 1.35              | 1.45              | 1.53 | V |
|  |                    |   | VLCD = 0EH                  | 1.40              | 1.50              | 1.58 | V |
|  |                    |   | VLCD = 0FH                  | 1.45              | 1.55              | 1.63 | V |
|  |                    |   | VLCD = 10H                  | 1.50              | 1.60              | 1.68 | V |
|  |                    |   | VLCD = 11H                  | 1.55              | 1.65              | 1.73 | V |
| VLCD = 12H                                     | 1.60               | 1.70                                    | 1.78                        | V                 |                   |      |   |
| VLCD = 13H                                     | 1.65               | 1.75                                    | 1.83                        | V                 |                   |      |   |
| Doubler output voltage                         | V <sub>L2</sub>    | C1 to C4 <sup>Note 1</sup> = 0.47 μF    | 2 V <sub>L1</sub><br>- 0.1  | 2 V <sub>L1</sub> | 2 V <sub>L1</sub> | V    |   |
| Tripler output voltage                         | V <sub>L4</sub>    | C1 to C4 <sup>Note 1</sup> = 0.47 μF    | 3 V <sub>L1</sub><br>- 0.15 | 3 V <sub>L1</sub> | 3 V <sub>L1</sub> | V    |   |
| Reference voltage setup time <sup>Note 2</sup> | t <sub>WAIT1</sub> |   | 5                           |                   |                   | ms   |   |
| Voltage boost wait time <sup>Note 3</sup>      | t <sub>WAIT2</sub> | C1 to C4 <sup>Note 1</sup> = 0.47 μF    | 500                         |                   |                   | ms   |   |

**Notes 1.** This is a capacitor that is connected between voltage pins used to drive the LCD.

C1: A capacitor connected between CAPH and CAPL

C2: A capacitor connected between V<sub>L1</sub> and GND

C3: A capacitor connected between V<sub>L2</sub> and GND

C4: A capacitor connected between V<sub>L4</sub> and GND

C1 = C2 = C3 = C4 = 0.47 μF ± 30%

- This is the time required to wait from when the reference voltage is specified by using the VLCD register (or when the internal voltage boosting method is selected [by setting the MDSET1 and MDSET0 bits of the LCDM0 register to 01B] if the default value reference voltage is used) until voltage boosting starts (VLCON = 1).
- This is the wait time from when voltage boosting is started (VLCON = 1) until display is enabled (LCDON = 1).

**(2) 1/4 bias method****(T<sub>A</sub> = -40 to +85°C, 1.8 V ≤ V<sub>DD</sub> ≤ 5.5 V, V<sub>SS</sub> = 0 V)**

| Parameter                                      | Symbol                            | Conditions                              | MIN.                     | TYP.              | MAX.              | Unit |   |
|--|-----------------------------------|---|--------------------------|-------------------|-------------------|------|---|
| LCD output voltage variation range             | V <sub>L1</sub> <sup>Note 4</sup> | C1 to C5 <sup>Note 1</sup><br>= 0.47 μF | VLCD = 04H               | 0.90              | 1.00              | 1.08 | V |
|  |                                   |   | VLCD = 05H               | 0.95              | 1.05              | 1.13 | V |
|  |                                   |   | VLCD = 06H               | 1.00              | 1.10              | 1.18 | V |
|  |                                   |   | VLCD = 07H               | 1.05              | 1.15              | 1.23 | V |
|  |                                   |   | VLCD = 08H               | 1.10              | 1.20              | 1.28 | V |
|  |                                   |   | VLCD = 09H               | 1.15              | 1.25              | 1.33 | V |
|  |                                   |   | VLCD = 0AH               | 1.20              | 1.30              | 1.38 | V |
|  |                                   |   | VLCD = 0BH               | 1.25              | 1.35              | 1.43 | V |
|  |                                   |   | VLCD = 0CH               | 1.30              | 1.40              | 1.48 | V |
|  |                                   |   | VLCD = 0DH               | 1.35              | 1.45              | 1.53 | V |
|  |                                   |   | VLCD = 0EH               | 1.40              | 1.50              | 1.58 | V |
|  |                                   |   | VLCD = 0FH               | 1.45              | 1.55              | 1.63 | V |
|  |                                   |   | VLCD = 10H               | 1.50              | 1.60              | 1.68 | V |
|  |                                   |   | VLCD = 11H               | 1.55              | 1.65              | 1.73 | V |
| VLCD = 12H                                     | 1.60                              | 1.70                                    | 1.78                     | V                 |                   |      |   |
| VLCD = 13H                                     | 1.65                              | 1.75                                    | 1.83                     | V                 |                   |      |   |
| Doubler output voltage                         | V <sub>L2</sub>                   | C1 to C5 <sup>Note 1</sup> = 0.47 μF    | 2 V <sub>L1</sub> - 0.08 | 2 V <sub>L1</sub> | 2 V <sub>L1</sub> | V    |   |
| Tripler output voltage                         | V <sub>L3</sub>                   | C1 to C5 <sup>Note 1</sup> = 0.47 μF    | 3 V <sub>L1</sub> - 0.12 | 3 V <sub>L1</sub> | 3 V <sub>L1</sub> | V    |   |
| Quadruply output voltage                       | V <sub>L4</sub> <sup>Note 4</sup> | C1 to C5 <sup>Note 1</sup> = 0.47 μF    | 4 V <sub>L1</sub> - 0.16 | 4 V <sub>L1</sub> | 4 V <sub>L1</sub> | V    |   |
| Reference voltage setup time <sup>Note 2</sup> | t <sub>WAIT1</sub>                |   | 5                        |                   |                   | ms   |   |
| Voltage boost wait time <sup>Note 3</sup>      | t <sub>WAIT2</sub>                | C1 to C5 <sup>Note 1</sup> = 0.47 μF    | 500                      |                   |                   | ms   |   |

**Notes 1.** This is a capacitor that is connected between voltage pins used to drive the LCD.

C1: A capacitor connected between CAPH and CAPL

C2: A capacitor connected between V<sub>L1</sub> and GNDC3: A capacitor connected between V<sub>L2</sub> and GNDC4: A capacitor connected between V<sub>L3</sub> and GNDC5: A capacitor connected between V<sub>L4</sub> and GND

C1 = C2 = C3 = C4 = C5 = 0.47 μF ± 30%

- This is the time required to wait from when the reference voltage is specified by using the VLCD register (or when the internal voltage boosting method is selected [by setting the MDSET1 and MDSET0 bits of the LCDM0 register to 01B] if the default value reference voltage is used) until voltage boosting starts (VLCON = 1).
- This is the wait time from when voltage boosting is started (VLCON = 1) until display is enabled (LCDON = 1).
- V<sub>L4</sub> must be 5.5 V or lower.

**2.7.3 Capacitor split method****1/3 bias method****(T<sub>A</sub> = -40 to +85°C, 2.2 V ≤ V<sub>DD</sub> ≤ 5.5 V, V<sub>SS</sub> = 0 V)**

| Parameter                                   | Symbol            | Conditions                           | MIN.                         | TYP.                | MAX.                         | Unit |
|---|-------------------|--------------------------------------|------------------------------|---------------------|------------------------------|------|
| V <sub>L4</sub> voltage                     | V <sub>L4</sub>   | C1 to C4 = 0.47 μF <sup>Note 2</sup> |                              | V <sub>DD</sub>     |                              | V    |
| V <sub>L2</sub> voltage                     | V <sub>L2</sub>   | C1 to C4 = 0.47 μF <sup>Note 2</sup> | 2/3 V <sub>L4</sub><br>- 0.1 | 2/3 V <sub>L4</sub> | 2/3 V <sub>L4</sub><br>+ 0.1 | V    |
| V <sub>L1</sub> voltage                     | V <sub>L1</sub>   | C1 to C4 = 0.47 μF <sup>Note 2</sup> | 1/3 V <sub>L4</sub><br>- 0.1 | 1/3 V <sub>L4</sub> | 1/3 V <sub>L4</sub><br>+ 0.1 | V    |
| Capacitor split wait time <sup>Note 1</sup> | t <sub>WAIT</sub> |                                      | 100                          |                     |                              | ms   |



- Notes**
1. This is the wait time from when voltage bucking is started (VLCON = 1) until display is enabled (LCDON = 1).
  2. This is a capacitor that is connected between voltage pins used to drive the LCD.
    - C1: A capacitor connected between CAPH and CAPL
    - C2: A capacitor connected between VL1 and GND
    - C3: A capacitor connected between VL2 and GND
    - C4: A capacitor connected between VL4 and GND
- C1 = C2 = C3 = C4 = 0.47  $\mu$ F $\pm$ 30%

### 2.8 RAM Data Retention Characteristics

(T<sub>A</sub> = -40 to +85°C, V<sub>SS</sub> = 0 V)

| Parameter                     | Symbol            | Conditions | MIN.                 | TYP. | MAX. | Unit |
|-------------------------------|-------------------|------------|----------------------|------|------|------|
| Data retention supply voltage | V <sub>DDDR</sub> |            | 1.46 <sup>Note</sup> |      | 5.5  | V    |

**Note** This depends on the POR detection voltage. For a falling voltage, data in RAM are retained until the voltage reaches the level that triggers a POR reset but not once it reaches the level at which a POR reset is generated.

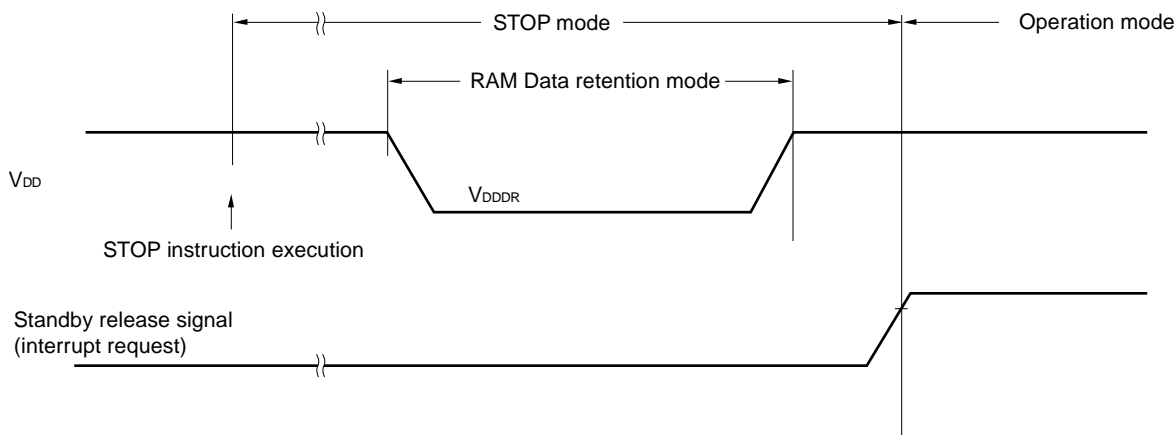

### 2.9 Flash Memory Programming Characteristics

(T<sub>A</sub> = -40 to +85°C, 1.8 V ≤ EV<sub>DD</sub> = V<sub>DD</sub> ≤ 5.5 V, V<sub>SS</sub> = EV<sub>SS</sub> = 0 V)

| Parameter  | Symbol            | Conditions                                     | MIN.    | TYP.      | MAX. | Unit  |
|--|-------------------|--|---------|-----------|------|-------|
| System clock frequency                                       | f <sub>CLK</sub>  | 1.8 V ≤ V <sub>DD</sub> ≤ 5.5 V                | 1       |           | 24   | MHz   |
| Number of code flash rewrites<br><small>Note 1, 2, 3</small> | C <sub>enwr</sub> | Retained for 20 years<br>T <sub>A</sub> = 85°C | 1,000   |           |      | Times |
| Number of data flash rewrites<br><small>Note 1, 2, 3</small> |                   | Retained for 1 year<br>T <sub>A</sub> = 25°C   |         | 1,000,000 |      |       |
|  |                   | Retained for 5 years<br>T <sub>A</sub> = 85°C  | 100,000 |           |      |       |
|  |                   | Retained for 20 years<br>T <sub>A</sub> = 85°C | 10,000  |           |      |       |

- Notes**
- 1 erase + 1 write after the erase is regarded as 1 rewrite. The retaining years are until next rewrite after the rewrite.
  2. When using flash memory programmer and Renesas Electronics self programming library
  3. This characteristic indicates the flash memory characteristic and based on Renesas Electronics reliability test.

**Remark** When updating data multiple times, use the flash memory as one for updating data.

### 2.10 Dedicated Flash Memory Programmer Communication (UART)

(T<sub>A</sub> = -40 to +85°C, 1.8 V ≤ EV<sub>DD</sub> = V<sub>DD</sub> ≤ 5.5 V, V<sub>SS</sub> = EV<sub>SS</sub> = 0 V)

| Parameter     | Symbol | Conditions                      | MIN.    | TYP. | MAX.      | Unit |
|---------------|--------|---------------------------------|---------|------|-----------|------|
| Transfer rate |        | During flash memory programming | 115,200 |      | 1,000,000 | bps  |

2.11 Timing Specifications for Switching Flash Memory Programming Modes

(T<sub>A</sub> = -40 to +85°C, 1.8 V ≤ EV<sub>DD</sub> = V<sub>DD</sub> ≤ 5.5 V, V<sub>SS</sub> = EV<sub>SS</sub> = 0 V)

| Parameter  | Symbol              | Conditions  | MIN. | TYP. | MAX. | Unit |
|--|---------------------|---|------|------|------|------|
| Time to complete the communication for the initial setting after the external reset is released  | t <sub>SUINIT</sub> | POR and LVD reset must be released before the external reset is released. |      |      | 100  | ms   |
| Time to release the external reset after the TOOL0 pin is set to the low level   | t <sub>SU</sub>     | POR and LVD reset must be released before the external reset is released. | 10   |      |      | μs   |
| Time to hold the TOOL0 pin at the low level after the external reset is released (excluding the processing time of the firmware to control the flash memory) | t <sub>HD</sub>     | POR and LVD reset must be released before the external reset is released. | 1    |      |      | ms   |

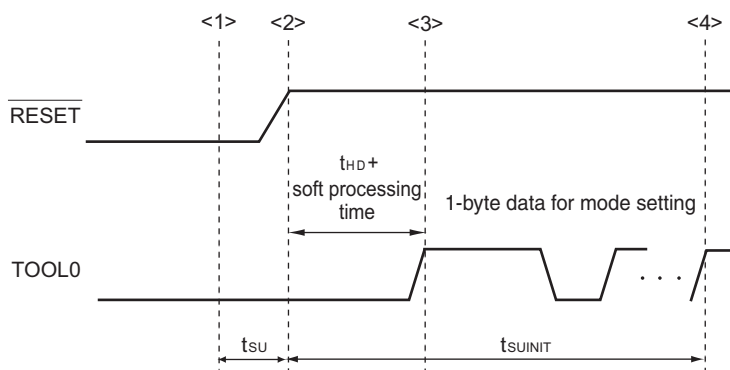

- <1> The low level is input to the TOOL0 pin.
- <2> The external reset is released (POR and LVD reset must be released before the external reset is released.).
- <3> The TOOL0 pin is set to the high level.
- <4> Setting of the flash memory programming mode by UART reception and complete the baud rate setting.

**Remark** t<sub>SUINIT</sub>: Communication for the initial setting must be completed within 100 ms after a reset is released during this period.

t<sub>SU</sub>: Time to release the external reset after the TOOL0 pin is set to the low level

t<sub>HD</sub>: Time to hold the TOOL0 pin at the low level after the external reset is released (excluding the processing time of the firmware to control the flash memory)

### 3. ELECTRICAL SPECIFICATIONS (G: $T_A = -40$ to $+105^\circ\text{C}$ )

This chapter describes the electrical specifications for the products "G: Industrial applications ( $T_A = -40$  to  $+105^\circ\text{C}$ )".

- Cautions**
1. The RL78 microcontrollers have an on-chip debug function, which is provided for development and evaluation. Do not use the on-chip debug function in products designated for mass production, because the guaranteed number of rewritable times of the flash memory may be exceeded when this function is used, and product reliability therefore cannot be guaranteed. Renesas Electronics is not liable for problems occurring when the on-chip debug function is used.
  2. With products not provided with an  $EV_{DD}$  or  $EV_{SS}$  pin, replace  $EV_{DD}$  with  $V_{DD}$ , or replace  $EV_{SS}$  with  $V_{SS}$ .
  3. For derating with  $T_A = +85$  to  $+105^\circ\text{C}$ , contact our Sales Division or the vender's sales division. Derating means the specified reduction in an operating parameter to improve reliability.

There are following differences between the products "G: Industrial applications ( $T_A = -40$  to  $+105^\circ\text{C}$ )" and the products "A: Consumer applications, and G: Industrial applications ( $T_A = -40$  to  $+85^\circ\text{C}$ )".

| Parameter                                    | Application  |   |
|--|--|---|
|  | A: Consumer applications,<br>G: Industrial applications<br>(with $T_A = -40$ to $+85^\circ\text{C}$ )  | G: Industrial applications  |
| Operating ambient temperature                | $T_A = -40$ to $+85^\circ\text{C}$   | $T_A = -40$ to $+105^\circ\text{C}$   |
| Operating mode<br>Operating voltage range    | HS (high-speed main) mode:<br>$2.7\text{ V} \leq V_{DD} \leq 5.5\text{ V}@1\text{ MHz to }32\text{ MHz}$<br>$2.4\text{ V} \leq V_{DD} \leq 5.5\text{ V}@1\text{ MHz to }16\text{ MHz}$<br>LS (low-speed main) mode:<br>$1.8\text{ V} \leq V_{DD} \leq 5.5\text{ V}@1\text{ MHz to }8\text{ MHz}$<br>LV (low-voltage main) mode:<br>$1.6\text{ V} \leq V_{DD} \leq 5.5\text{ V}@1\text{ MHz to }4\text{ MHz}$ | HS (high-speed main) mode only:<br>$2.7\text{ V} \leq V_{DD} \leq 5.5\text{ V}@1\text{ MHz to }32\text{ MHz}$<br>$2.4\text{ V} \leq V_{DD} \leq 5.5\text{ V}@1\text{ MHz to }16\text{ MHz}$                 |
| High-speed on-chip oscillator clock accuracy | $1.8\text{ V} \leq V_{DD} \leq 5.5\text{ V}$ :<br>$\pm 1.0\%$ @ $T_A = -20$ to $+85^\circ\text{C}$<br>$\pm 1.5\%$ @ $T_A = -40$ to $-20^\circ\text{C}$<br>$1.6\text{ V} \leq V_{DD} < 1.8\text{ V}$ :<br>$\pm 5.0\%$ @ $T_A = -20$ to $+85^\circ\text{C}$<br>$\pm 5.5\%$ @ $T_A = -40$ to $-20^\circ\text{C}$  | $2.4\text{ V} \leq V_{DD} \leq 5.5\text{ V}$ :<br>$\pm 2.0\%$ @ $T_A = +85$ to $+105^\circ\text{C}$<br>$\pm 1.0\%$ @ $T_A = -20$ to $+85^\circ\text{C}$<br>$\pm 1.5\%$ @ $T_A = -40$ to $-20^\circ\text{C}$ |
| Serial array unit                            | UART<br>CSI00: $f_{CLK}/2$ (supporting 16 Mbps), $f_{CLK}/4$<br>CSI01<br>Simplified I <sup>2</sup> C communication   | UART<br>CSI00: $f_{CLK}/4$<br>CSI01<br>Simplified I <sup>2</sup> C communication  |
| IICA   | Normal mode<br>Fast mode<br>Fast mode plus   | Normal mode<br>Fast mode  |
| Voltage detector                             | Rise detection voltage: 1.67 V to 4.06 V<br>(14 levels)<br>Fall detection voltage: 1.63 V to 3.98 V<br>(14 levels)   | Rise detection voltage: 2.61 V to 4.06 V<br>(8 levels)<br>Fall detection voltage: 2.55 V to 3.98 V<br>(8 levels)  |

**Remark** The electrical characteristics of the products G: Industrial applications ( $T_A = -40$  to  $+105^\circ\text{C}$ ) are different from those of the products "A: Consumer applications, and G: Industrial applications (only with  $T_A = -40$  to  $+85^\circ\text{C}$ )". For details, refer to 3.1 to 3.11.

## 3.1 Absolute Maximum Ratings

Absolute Maximum Ratings (T<sub>A</sub> = 25°C)

(1/3)

| Parameter              | Symbols            | Conditions   | Ratings   | Unit |
|------------------------|--------------------|--|---|------|
| Supply voltage         | V <sub>DD</sub>    | V <sub>DD</sub> = EV <sub>DD</sub>   | -0.5 to +6.5  | V    |
|                        | EV <sub>DD</sub>   | V <sub>DD</sub> = EV <sub>DD</sub>   | -0.5 to +6.5  | V    |
|                        | EV <sub>SS</sub>   |  | -0.5 to +0.3  | V    |
| REGC pin input voltage | V <sub>IREGC</sub> | REGC   | -0.3 to +2.8<br>and -0.3 to V <sub>DD</sub> + 0.3 <sup>Note 1</sup>                             | V    |
| Input voltage          | V <sub>I1</sub>    | P10 to P17, P30 to P32, P40 to P43,<br>P50 to P54, P70 to P74, P120, P125 to P127, P140<br>to P147                 | -0.3 to EV <sub>DD</sub> + 0.3<br>and -0.3 to V <sub>DD</sub> + 0.3 <sup>Note 2</sup>           | V    |
|                        | V <sub>I2</sub>    | P60, P61 (N-ch open-drain)   | -0.3 to EV <sub>DD</sub> + 0.3<br>and -0.3 to V <sub>DD</sub> + 0.3 <sup>Note 2</sup>           | V    |
|                        | V <sub>I3</sub>    | P20, P21, P121 to P124, P137, EXCLK, EXCLKS,<br>RESET  | -0.3 to V <sub>DD</sub> + 0.3 <sup>Note 2</sup>   | V    |
| Output voltage         | V <sub>O1</sub>    | P10 to P17, P30 to P32, P40 to P43, P50 to P54,<br>P60, P61, P70 to P74, P120, P125 to P127, P130,<br>P140 to P147 | -0.3 to EV <sub>DD</sub> + 0.3<br>and -0.3 to V <sub>DD</sub> + 0.3 <sup>Note 2</sup>           | V    |
|                        | V <sub>O2</sub>    | P20, P21   | -0.3 to V <sub>DD</sub> + 0.3 <sup>Note 2</sup>   | V    |
| Analog input voltage   | V <sub>AI1</sub>   | ANI16 to ANI23   | -0.3 to EV <sub>DD</sub> + 0.3<br>and -0.3 to AV <sub>REF</sub> (+) + 0.3 <sup>Notes 2, 3</sup> | V    |
|                        | V <sub>AI2</sub>   | ANI0, ANI1   | -0.3 to V <sub>DD</sub> + 0.3<br>and -0.3 to AV <sub>REF</sub> (+) + 0.3 <sup>Notes 2, 3</sup>  | V    |

**Notes 1.** Connect the REGC pin to V<sub>SS</sub> via a capacitor (0.47 to 1 μF). This value regulates the absolute maximum rating of the REGC pin. Do not use this pin with voltage applied to it.

**2.** Must be 6.5 V or lower.

**3.** Do not exceed AV<sub>REF</sub>(+) + 0.3 V in case of A/D conversion target pin.

**Caution** Product quality may suffer if the absolute maximum rating is exceeded even momentarily for any parameter. That is, the absolute maximum ratings are rated values at which the product is on the verge of suffering physical damage, and therefore the product must be used under conditions that ensure that the absolute maximum ratings are not exceeded.

**Remarks 1.** Unless specified otherwise, the characteristics of alternate-function pins are the same as those of the port pins.

**2.** AV<sub>REF</sub>(+) : + side reference voltage of the A/D converter.

**3.** V<sub>SS</sub> : Reference voltage

**Absolute Maximum Ratings (T<sub>A</sub> = 25°C)****(2/3)**

| Parameter   | Symbols           | Conditions   | Ratings  | Unit  |
|-------------|-------------------|--|--|---|
| LCD voltage | V <sub>L1</sub>   | V <sub>L1</sub> voltage <sup>Note 1</sup>            | -0.3 to +2.8<br>and -0.3 to V <sub>L4</sub> + 0.3  | V   |
|             | V <sub>L2</sub>   | V <sub>L2</sub> voltage <sup>Note 1</sup>            | -0.3 to V <sub>L4</sub> + 0.3 <sup>Note 2</sup>  | V   |
|             | V <sub>L3</sub>   | V <sub>L3</sub> voltage <sup>Note 1</sup>            | -0.3 to V <sub>L4</sub> + 0.3 <sup>Note 2</sup>  | V   |
|             | V <sub>L4</sub>   | V <sub>L4</sub> voltage <sup>Note 1</sup>            | -0.3 to +6.5   | V   |
|             | V <sub>LCAP</sub> | CAPL, CAPH voltage <sup>Note 1</sup>                 | -0.3 to V <sub>L4</sub> + 0.3 <sup>Note 2</sup>  | V   |
|             | V <sub>LOUT</sub> | COM0 to COM7,<br>SEG0 to<br>SEG38,<br>output voltage | External resistance division<br>method<br>Capacitor split method<br>Internal voltage boosting method | -0.3 to V <sub>DD</sub> + 0.3 <sup>Note 2</sup><br>-0.3 to V <sub>DD</sub> + 0.3 <sup>Note 2</sup><br>-0.3 to V <sub>L4</sub> + 0.3 <sup>Note 2</sup> |

**Notes 1.** This value only indicates the absolute maximum ratings when applying voltage to the V<sub>L1</sub>, V<sub>L2</sub>, V<sub>L3</sub>, and V<sub>L4</sub> pins; it does not mean that applying voltage to these pins is recommended. When using the internal voltage boosting method or capacitance split method, connect these pins to V<sub>SS</sub> via a capacitor (0.47 μF ± 30%) and connect a capacitor (0.47 μF ± 30%) between the CAPL and CAPH pins.

**2.** Must be 6.5 V or lower.

**Caution** Product quality may suffer if the absolute maximum rating is exceeded even momentarily for any parameter. That is, the absolute maximum ratings are rated values at which the product is on the verge of suffering physical damage, and therefore the product must be used under conditions that ensure that the absolute maximum ratings are not exceeded.

**Remark** V<sub>SS</sub> : Reference voltage

**Absolute Maximum Ratings (T<sub>A</sub> = 25°C)****(3/3)**

| Parameter                     | Symbols          | Conditions                       |  | Ratings     | Unit |
|-------------------------------|------------------|----------------------------------|--|-------------|------|
| Output current, high          | I <sub>OH1</sub> | Per pin                          | P10 to P17, P30 to P32, P40 to P43, P50 to P54, P70 to P74, P120, P125 to P127, P130, P140 to P147           | -40         | mA   |
|                               |                  | Total of all pins<br>-170 mA     | P10 to P14, P40 to P43, P120, P130, P140 to P147   | -70         | mA   |
|                               |                  |                                  | P15 to P17, P30 to P32, P50 to P54, P70 to P74, P125 to P127   | -100        | mA   |
|                               | I <sub>OH2</sub> | Per pin                          | P20, P21   | -0.5        | mA   |
|                               |                  | Total of all pins                |  | -1          | mA   |
| Output current, low           | I <sub>OL1</sub> | Per pin                          | P10 to P17, P30 to P32, P40 to P43, P50 to P54, P60, P61, P70 to P74, P120, P125 to P127, P130, P140 to P147 | 40          | mA   |
|                               |                  | Total of all pins<br>170 mA      | P10 to P14, P40 to P43, P120, P130, P140 to P147   | 70          | mA   |
|                               |                  |                                  | P15 to P17, P30 to P32, P50 to P54, P60, P61, P70 to P74, P125 to P127                                       | 100         | mA   |
|                               | I <sub>OL2</sub> | Per pin                          | P20, P21   | 1           | mA   |
|                               |                  | Total of all pins                |  | 2           | mA   |
| Operating ambient temperature | T <sub>A</sub>   | In normal operation mode         |  | -40 to +105 | °C   |
|                               |                  | In flash memory programming mode |  |             |      |
| Storage temperature           | T <sub>stg</sub> |                                  |  | -65 to +150 | °C   |

**Caution** Product quality may suffer if the absolute maximum rating is exceeded even momentarily for any parameter. That is, the absolute maximum ratings are rated values at which the product is on the verge of suffering physical damage, and therefore the product must be used under conditions that ensure that the absolute maximum ratings are not exceeded.

**Remark** Unless specified otherwise, the characteristics of alternate-function pins are the same as those of the port pins.



## 3.2 Oscillator Characteristics

### 3.2.1 X1, XT1 oscillator characteristics

(T<sub>A</sub> = -40 to +105°C, 2.4 V ≤ EV<sub>DD</sub> = V<sub>DD</sub> ≤ 5.5 V, V<sub>SS</sub> = EV<sub>SS</sub> = 0 V)

| Parameter  | Resonator                               | Conditions                      | MIN. | TYP.   | MAX. | Unit |
|--|---|---------------------------------|------|--------|------|------|
| X1 clock oscillation frequency (f <sub>X</sub> ) <sup>Note</sup>   | Ceramic resonator/<br>crystal resonator | 2.7 V ≤ V <sub>DD</sub> ≤ 5.5 V | 1.0  |        | 20.0 | MHz  |
|  |   | 2.4 V ≤ V <sub>DD</sub> < 2.7 V | 1.0  |        | 16.0 | MHz  |
| XT1 clock oscillation frequency (f <sub>XT</sub> ) <sup>Note</sup> | Crystal resonator                       |                                 | 32   | 32.768 | 35   | kHz  |

**Note** Indicates only permissible oscillator frequency ranges. Refer to **3.4 AC Characteristics** for instruction execution time. Request evaluation by the manufacturer of the oscillator circuit mounted on a board to check the oscillator characteristics.

**Caution** Since the CPU is started by the high-speed on-chip oscillator clock after a reset release, check the X1 clock oscillation stabilization time using the oscillation stabilization time counter status register (OSTC) by the user. Determine the oscillation stabilization time of the OSTC register and the oscillation stabilization time select register (OSTS) after sufficiently evaluating the oscillation stabilization time with the resonator to be used.

### 3.2.2 On-chip oscillator characteristics

(T<sub>A</sub> = -40 to +105°C, 2.4 V ≤ EV<sub>DD</sub> = V<sub>DD</sub> ≤ 5.5 V, V<sub>SS</sub> = EV<sub>SS</sub> = 0 V)

| Oscillators   | Parameters      | Conditions    |                                 | MIN. | TYP. | MAX. | Unit |
|---|-----------------|---------------|---------------------------------|------|------|------|------|
| High-speed on-chip oscillator clock frequency <sup>Notes 1, 2</sup> | f <sub>IH</sub> |               |                                 | 1    |      | 24   | MHz  |
| High-speed on-chip oscillator clock frequency accuracy              |                 | -20 to +85°C  | 2.4 V ≤ V <sub>DD</sub> ≤ 5.5 V | -1   |      | +1   | %    |
|   |                 | -40 to -20°C  | 2.4 V ≤ V <sub>DD</sub> ≤ 5.5 V | -1.5 |      | +1.5 | %    |
|   |                 | +85 to +105°C | 2.4 V ≤ V <sub>DD</sub> ≤ 5.5 V | -2.0 |      | +2.0 | %    |
| Low-speed on-chip oscillator clock frequency                        | f <sub>IL</sub> |               |                                 |      | 15   |      | kHz  |
| Low-speed on-chip oscillator clock frequency accuracy               |                 |               |                                 | -15  |      | +15  | %    |

**Notes 1.** High-speed on-chip oscillator frequency is selected by bits 0 to 3 of option byte (000C2H) and bits 0 to 2 of HOCODIV register.

**2.** This indicates the oscillator characteristics only. Refer to **3.4 AC Characteristics** for instruction execution time.

## 3.3 DC Characteristics

## 3.3.1 Pin characteristics

(T<sub>A</sub> = -40 to +105°C, 2.4 V ≤ EV<sub>DD</sub> = V<sub>DD</sub> ≤ 5.5 V, V<sub>SS</sub> = EV<sub>SS</sub> = 0 V)

(1/5)

| Items                                  | Symbol  | Conditions   | MIN.                             | TYP.                            | MAX.                   | Unit  |      |
|--|---|--|----------------------------------|---------------------------------|------------------------|-------|------|
| Output current, high <sup>Note 1</sup> | I <sub>OH1</sub>  | Per pin for P10 to P17, P30 to P32, P40 to P43, P50 to P54, P70 to P74, P120, P125 to P127, P130, P140 to P147 |                                  |                                 | -3.0 <sup>Note 2</sup> | mA    |      |
|  |   | Total of P10 to P14, P40 to P43, P120, P130, P140 to P147<br>(When duty = 70% <sup>Note 3</sup> )              | 4.0 V ≤ EV <sub>DD</sub> ≤ 5.5 V |                                 |                        | -30.0 | mA   |
|  |   |  | 2.7 V ≤ EV <sub>DD</sub> < 4.0 V |                                 |                        | -8.0  | mA   |
|  |   |  | 2.4 V ≤ EV <sub>DD</sub> < 2.7 V |                                 |                        | -4.0  | mA   |
|  |   | Total of P15 to P17, P30 to P32, P50 to P54, P70 to P74, P125 to P127<br>(When duty = 70% <sup>Note 3</sup> )  | 4.0 V ≤ EV <sub>DD</sub> ≤ 5.5 V |                                 |                        | -30.0 | mA   |
|  |   |  | 2.7 V ≤ EV <sub>DD</sub> < 4.0 V |                                 |                        | -15.0 | mA   |
|  |   |  | 2.4 V ≤ EV <sub>DD</sub> < 2.7 V |                                 |                        | -8.0  | mA   |
|  | Total of all pins<br>(When duty = 70% <sup>Note 3</sup> ) |  |                                  |                                 | -60.0                  | mA    |      |
|  | I <sub>OH2</sub>  | P20, P21   | Per pin                          |                                 |                        | -0.1  | mA   |
|  |   |  | Total of all pins                | 2.4 V ≤ V <sub>DD</sub> ≤ 5.5 V |                        |       | -0.2 |

**Notes** 1. Value of current at which the device operation is guaranteed even if the current flows from the V<sub>DD</sub> and EV<sub>DD</sub> pins to an output pin.

2. Do not exceed the total current value.

3. Specification under conditions where the duty factor ≤ 70%.

The output current value that has changed to the duty factor > 70% the duty ratio can be calculated with the following expression (when changing the duty factor from 70% to n%).

- Total output current of pins = (I<sub>OH</sub> × 0.7)/(n × 0.01)

<Example> Where n = 80% and I<sub>OH</sub> = -30.0 mA

$$\text{Total output current of pins} = (-30.0 \times 0.7)/(80 \times 0.01) \cong -26.25 \text{ mA}$$

However, the current that is allowed to flow into one pin does not vary depending on the duty factor. A current higher than the absolute maximum rating must not flow into one pin.

**Caution** P10, P12, P15, and P17 do not output high level in N-ch open-drain mode.

**Remark** Unless specified otherwise, the characteristics of alternate-function pins are the same as those of the port pins.

(T<sub>A</sub> = -40 to +105°C, 2.4 V ≤ EV<sub>DD</sub> = V<sub>DD</sub> ≤ 5.5 V, V<sub>SS</sub> = EV<sub>SS</sub> = 0 V)

(2/5)

| Items  | Symbol  | Conditions  |                                  | MIN. | TYP. | MAX.                   | Unit |    |
|--|---|---|----------------------------------|------|------|------------------------|------|----|
| Output current,<br>I <sub>OL</sub> <sup>Note 1</sup> | I <sub>OL1</sub>  | Per pin for P10 to P17, P30 to P32, P40 to P43, P50 to P54, P70 to P74, P120, P125 to P127, P130, P140 to P147          |                                  |      |      | 8.5 <sup>Note 2</sup>  | mA   |    |
|  |   | Per pin for P60, P61  |                                  |      |      | 15.0 <sup>Note 2</sup> | mA   |    |
|  |   | Total of P10 to P14, P40 to P43, P120, P130, P140 to P147<br>(When duty = 70% <sup>Note 3</sup> )                       | 4.0 V ≤ EV <sub>DD</sub> ≤ 5.5 V |      |      | 40.0                   | mA   |    |
|  |   |   | 2.7 V ≤ EV <sub>DD</sub> < 4.0 V |      |      | 15.0                   | mA   |    |
|  |   |   | 2.4 V ≤ EV <sub>DD</sub> < 2.7 V |      |      | 9.0                    | mA   |    |
|  |   | Total of P15 to P17, P30 to P32, P50 to P54, P60, P61, P70 to P74, P125 to P127<br>(When duty = 70% <sup>Note 3</sup> ) | 4.0 V ≤ EV <sub>DD</sub> ≤ 5.5 V |      |      | 40.0                   | mA   |    |
|  |   |   | 2.7 V ≤ EV <sub>DD</sub> < 4.0 V |      |      | 35.0                   | mA   |    |
|  | 2.4 V ≤ EV <sub>DD</sub> < 2.7 V                          |   |                                  |      | 20.0 | mA                     |      |    |
|  | Total of all pins<br>(When duty = 70% <sup>Note 3</sup> ) |   |                                  |      |      |                        | 80.0 | mA |
|  | I <sub>OL2</sub>  | P20, P21  | Per pin                          |      |      |                        | 0.4  | mA |
| Total of all pins                                    |   |   | 2.4 V ≤ V <sub>DD</sub> ≤ 5.5 V  |      |      | 0.8                    | mA   |    |

- Notes**
- Value of current at which the device operation is guaranteed even if the current flows from the V<sub>DD</sub> and EV<sub>DD</sub> pins to an output pin.
  - Do not exceed the total current value.
  - Specification under conditions where the duty factor ≤ 70%.

The output current value that has changed to the duty factor > 70% the duty ratio can be calculated with the following expression (when changing the duty factor from 70% to n%).

- Total output current of pins = (I<sub>OL</sub> × 0.7)/(n × 0.01)

<Example> Where n = 80% and I<sub>OL</sub> = 40.0 mA

$$\text{Total output current of pins} = (40.0 \times 0.7)/(80 \times 0.01) \cong 35.0 \text{ mA}$$

However, the current that is allowed to flow into one pin does not vary depending on the duty factor. A current higher than the absolute maximum rating must not flow into one pin.

**Remark** Unless specified otherwise, the characteristics of alternate-function pins are the same as those of the port pins.

(T<sub>A</sub> = -40 to +105°C, 2.4 V ≤ EV<sub>DD</sub> = V<sub>DD</sub> ≤ 5.5 V, V<sub>SS</sub> = EV<sub>SS</sub> = 0 V)

(3/5)

| Items               | Symbol           | Conditions   | MIN.   | TYP.                | MAX. | Unit                |   |
|---------------------|------------------|--|--|---------------------|------|---------------------|---|
| Input voltage, high | V <sub>IH1</sub> | P10 to P17, P30 to P32, P40 to P43, P50 to P54, P70 to P74, P120, P125 to P127, P140 to P147 | Normal input buffer                                  | 0.8EV <sub>DD</sub> |      | EV <sub>DD</sub>    | V |
|                     | V <sub>IH2</sub> | P10, P11, P15, P16   | TTL input buffer<br>4.0 V ≤ EV <sub>DD</sub> ≤ 5.5 V | 2.2                 |      | EV <sub>DD</sub>    | V |
|                     |                  |  | TTL input buffer<br>3.3 V ≤ EV <sub>DD</sub> < 4.0 V | 2.0                 |      | EV <sub>DD</sub>    | V |
|                     |                  |  | TTL input buffer<br>2.4 V ≤ EV <sub>DD</sub> < 3.3 V | 1.50                |      | EV <sub>DD</sub>    | V |
|                     | V <sub>IH3</sub> | P20, P21   |  | 0.7V <sub>DD</sub>  |      | V <sub>DD</sub>     | V |
|                     | V <sub>IH4</sub> | P60, P61   |  | 0.7EV <sub>DD</sub> |      | EV <sub>DD</sub>    | V |
|                     | V <sub>IH5</sub> | P121 to P124, P137, EXCLK, EXCLKS, $\overline{\text{RESET}}$                                 |  | 0.8V <sub>DD</sub>  |      | V <sub>DD</sub>     | V |
| Input voltage, low  | V <sub>IL1</sub> | P10 to P17, P30 to P32, P40 to P43, P50 to P54, P70 to P74, P120, P125 to P127, P140 to P147 | Normal input buffer                                  | 0                   |      | 0.2EV <sub>DD</sub> | V |
|                     | V <sub>IL2</sub> | P10, P11, P15, P16   | TTL input buffer<br>4.0 V ≤ EV <sub>DD</sub> ≤ 5.5 V | 0                   |      | 0.8                 | V |
|                     |                  |  | TTL input buffer<br>3.3 V ≤ EV <sub>DD</sub> < 4.0 V | 0                   |      | 0.5                 | V |
|                     |                  |  | TTL input buffer<br>2.4 V ≤ EV <sub>DD</sub> < 3.3 V | 0                   |      | 0.32                | V |
|                     | V <sub>IL3</sub> | P20, P21   |  | 0                   |      | 0.3V <sub>DD</sub>  | V |
|                     | V <sub>IL4</sub> | P60, P61   |  | 0                   |      | 0.3EV <sub>DD</sub> | V |
|                     | V <sub>IL5</sub> | P121 to P124, P137, EXCLK, EXCLKS, $\overline{\text{RESET}}$                                 |  | 0                   |      | 0.2V <sub>DD</sub>  | V |

**Caution** The maximum value of V<sub>IH</sub> of pins P10, P12, P15, and P17 is EV<sub>DD</sub>, even in the N-ch open-drain mode.

**Remark** Unless specified otherwise, the characteristics of alternate-function pins are the same as those of the port pins.

(T<sub>A</sub> = -40 to +105°C, 2.4 V ≤ EV<sub>DD</sub> = V<sub>DD</sub> ≤ 5.5 V, V<sub>SS</sub> = EV<sub>SS</sub> = 0 V)

(4/5)

| Items                | Symbol           | Conditions   | MIN.   | TYP.                   | MAX. | Unit |
|----------------------|------------------|--|--|------------------------|------|------|
| Output voltage, high | V <sub>OH1</sub> | P10 to P17, P30 to P32, P40 to P43, P50 to P54, P70 to P74, P120, P125 to P127, P130, P140 to P147 | 4.0 V ≤ EV <sub>DD</sub> ≤ 5.5 V, I <sub>OH1</sub> = -3.0 mA | EV <sub>DD</sub> - 0.7 |      | V    |
|                      |                  |  | 2.7 V ≤ EV <sub>DD</sub> ≤ 5.5 V, I <sub>OH1</sub> = -2.0 mA | EV <sub>DD</sub> - 0.6 |      | V    |
|                      |                  |  | 2.4 V ≤ EV <sub>DD</sub> ≤ 5.5 V, I <sub>OH1</sub> = -1.5 mA | EV <sub>DD</sub> - 0.5 |      | V    |
|                      | V <sub>OH2</sub> | P20, P21   | 2.4 V ≤ V <sub>DD</sub> ≤ 5.5 V, I <sub>OH2</sub> = -100 μA  | V <sub>DD</sub> - 0.5  |      | V    |
| Output voltage, low  | V <sub>OL1</sub> | P10 to P17, P30 to P32, P40 to P43, P50 to P54, P70 to P74, P120, P125 to P127, P130, P140 to P147 | 4.0 V ≤ EV <sub>DD</sub> ≤ 5.5 V, I <sub>OL1</sub> = 8.5 mA  |                        | 0.7  | V    |
|                      |                  |  | 2.7 V ≤ EV <sub>DD</sub> ≤ 5.5 V, I <sub>OL1</sub> = 3.0 mA  |                        | 0.6  | V    |
|                      |                  |  | 2.7 V ≤ EV <sub>DD</sub> ≤ 5.5 V, I <sub>OL1</sub> = 1.5 mA  |                        | 0.4  | V    |
|                      |                  |  | 2.4 V ≤ EV <sub>DD</sub> ≤ 5.5 V, I <sub>OL1</sub> = 0.6 mA  |                        | 0.4  | V    |
|                      | V <sub>OL2</sub> | P20, P21   | 2.4 V ≤ V <sub>DD</sub> ≤ 5.5 V, I <sub>OL2</sub> = 400 μA   |                        | 0.4  | V    |
|                      | V <sub>OL3</sub> | P60, P61   | 4.0 V ≤ EV <sub>DD</sub> ≤ 5.5 V, I <sub>OL3</sub> = 15.0 mA |                        | 2.0  | V    |
|                      |                  |  | 4.0 V ≤ EV <sub>DD</sub> ≤ 5.5 V, I <sub>OL3</sub> = 5.0 mA  |                        | 0.4  | V    |
|                      |                  |  | 2.7 V ≤ EV <sub>DD</sub> ≤ 5.5 V, I <sub>OL3</sub> = 3.0 mA  |                        | 0.4  | V    |
|                      |                  |  | 2.4 V ≤ EV <sub>DD</sub> ≤ 5.5 V, I <sub>OL3</sub> = 2.0 mA  |                        | 0.4  | V    |

**Caution** P10, P12, P15, and P17 do not output high level in N-ch open-drain mode.

**Remark** Unless specified otherwise, the characteristics of alternate-function pins are the same as those of the port pins.

(T<sub>A</sub> = -40 to +105°C, 2.4 V ≤ EV<sub>DD</sub> = V<sub>DD</sub> ≤ 5.5 V, V<sub>SS</sub> = EV<sub>SS</sub> = 0 V)

(5/5)

| Items                       | Symbol            | Conditions   |  | MIN.                                  | TYP. | MAX. | Unit |    |
|-----------------------------|-------------------|--|--|---------------------------------------|------|------|------|----|
| Input leakage current, high | I <sub>LIH1</sub> | P10 to P17, P30 to P32, P40 to P43, P50 to P54, P60, P61, P70 to P74, P120, P125 to P127, P140 to P147 | V <sub>I</sub> = EV <sub>DD</sub>                      |                                       |      | 1    | μA   |    |
|                             | I <sub>LIH2</sub> | P20, P21, P137, RESET  | V <sub>I</sub> = V <sub>DD</sub>                       |                                       |      | 1    | μA   |    |
|                             | I <sub>LIH3</sub> | P121 to P124 (X1, X2, XT1, XT2, EXCLK, EXCLKS)   | V <sub>I</sub> = V <sub>DD</sub>                       | In input port or external clock input |      |      | 1    | μA |
|                             |                   |  |  | In resonator connection               |      |      | 10   | μA |
| Input leakage current, low  | I <sub>LIL1</sub> | P10 to P17, P30 to P32, P40 to P43, P50 to P54, P60, P61, P70 to P74, P120, P125 to P127, P140 to P147 | V <sub>I</sub> = EV <sub>SS</sub>                      |                                       |      | -1   | μA   |    |
|                             | I <sub>LIL2</sub> | P20, P21, P137, RESET  | V <sub>I</sub> = V <sub>SS</sub>                       |                                       |      | -1   | μA   |    |
|                             | I <sub>LIL3</sub> | P121 to P124 (X1, X2, XT1, XT2, EXCLK, EXCLKS)   | V <sub>I</sub> = V <sub>SS</sub>                       | In input port or external clock input |      |      | -1   | μA |
|                             |                   |  |  | In resonator connection               |      |      | -10  | μA |
| On-chip pll-up resistance   | R <sub>U1</sub>   | V <sub>I</sub> = EV <sub>SS</sub>  | SEGxx port   |                                       |      |      |      |    |
|                             |                   |  | 2.4 V ≤ EV <sub>DD</sub> = V <sub>DD</sub> ≤ 5.5 V     | 10                                    | 20   | 100  | kΩ   |    |
|                             | R <sub>U2</sub>   |  | Ports other than above (Except for P60, P61, and P130) | 10                                    | 20   | 100  | kΩ   |    |

**Remark** Unless specified otherwise, the characteristics of alternate-function pins are the same as those of the port pins.

## 3.3.2 Supply current characteristics

(T<sub>A</sub> = -40 to +105°C, 2.4 V ≤ EV<sub>DD</sub> = V<sub>DD</sub> ≤ 5.5 V, V<sub>SS</sub> = EV<sub>SS</sub> = 0 V)

(1/3)

| Parameter  | Symbol           | Conditions  |   |   |                         | MIN.                    | TYP. | MAX. | Unit |    |
|--|------------------|---|---|---|-------------------------|-------------------------|------|------|------|----|
| Supply current<br>Note 1   | I <sub>DD1</sub> | Operating mode  | HS (high-speed main) mode<br>Note 5                               | f <sub>IH</sub> = 24 MHz<br>Note 3                          | Basic operation         | V <sub>DD</sub> = 5.0 V |      | 1.5  |      | mA |
|  |                  |   |   |   |                         | V <sub>DD</sub> = 3.0 V |      | 1.5  |      | mA |
|  |                  |   |   |   | Normal operation        | V <sub>DD</sub> = 5.0 V |      | 3.3  | 5.3  | mA |
|  |                  |   |   |   | V <sub>DD</sub> = 3.0 V |                         | 3.3  | 5.3  | mA   |    |
|  |                  |   |   | Normal operation  | V <sub>DD</sub> = 5.0 V |                         | 2.5  | 3.9  | mA   |    |
|  |                  |   |   |   | V <sub>DD</sub> = 3.0 V |                         | 2.5  | 3.9  | mA   |    |
|  |                  |   | HS (high-speed main) mode<br>Note 5                               | f <sub>MX</sub> = 20 MHz<br>Note 2, V <sub>DD</sub> = 5.0 V | Normal operation        | Square wave input       |      | 2.8  | 4.7  | mA |
|  |                  |   |   |   |                         | Resonator connection    |      | 3.0  | 4.8  | mA |
|  |                  |   |   | f <sub>MX</sub> = 20 MHz<br>Note 2, V <sub>DD</sub> = 3.0 V | Normal operation        | Square wave input       |      | 2.8  | 4.7  | mA |
|  |                  |   |   |   |                         | Resonator connection    |      | 3.0  | 4.8  | mA |
|  |                  | f <sub>MX</sub> = 10 MHz<br>Note 2, V <sub>DD</sub> = 5.0 V |   | Normal operation  | Square wave input       |                         | 1.8  | 2.8  | mA   |    |
|  |                  |   |   |   | Resonator connection    |                         | 1.8  | 2.8  | mA   |    |
|  |                  | f <sub>MX</sub> = 10 MHz<br>Note 2, V <sub>DD</sub> = 3.0 V |   | Normal operation  | Square wave input       |                         | 1.8  | 2.8  | mA   |    |
|  |                  |   |   |   | Resonator connection    |                         | 1.8  | 2.8  | mA   |    |
|  |                  | Subsystem clock operation                                   | f <sub>SUB</sub> = 32.768 kHz<br>Note 4<br>T <sub>A</sub> = -40°C | Normal operation  | Square wave input       |                         | 3.5  | 4.9  | μA   |    |
|  |                  |   |   |   | Resonator connection    |                         | 3.6  | 5.0  | μA   |    |
|  |                  |   | f <sub>SUB</sub> = 32.768 kHz<br>Note 4<br>T <sub>A</sub> = +25°C | Normal operation  | Square wave input       |                         | 3.6  | 4.9  | μA   |    |
|  |                  |   |   |   | Resonator connection    |                         | 3.7  | 5.0  | μA   |    |
|  |                  |   | f <sub>SUB</sub> = 32.768 kHz<br>Note 4<br>T <sub>A</sub> = +50°C | Normal operation  | Square wave input       |                         | 3.7  | 5.5  | μA   |    |
|  |                  |   |   |   | Resonator connection    |                         | 3.8  | 5.6  | μA   |    |
| f <sub>SUB</sub> = 32.768 kHz<br>Note 4<br>T <sub>A</sub> = +70°C  | Normal operation |   | Square wave input   |   | 3.8                     | 6.3                     | μA   |      |      |    |
|  |                  |   | Resonator connection  |   | 3.9                     | 6.4                     | μA   |      |      |    |
| f <sub>SUB</sub> = 32.768 kHz<br>Note 4<br>T <sub>A</sub> = +85°C  | Normal operation | Square wave input   |   | 4.1   | 7.7                     | μA                      |      |      |      |    |
|  |                  | Resonator connection  |   | 4.2   | 7.8                     | μA                      |      |      |      |    |
| f <sub>SUB</sub> = 32.768 kHz<br>Note 4<br>T <sub>A</sub> = +105°C | Normal operation | Square wave input   |   | 6.4   | 19.7                    | μA                      |      |      |      |    |
|  |                  | Resonator connection  |   | 6.5   | 19.8                    | μA                      |      |      |      |    |

(Notes and Remarks are listed on the next page.)

- Notes**
1. Total current flowing into V<sub>DD</sub> and EV<sub>DD</sub>, including the input leakage current flowing when the level of the input pin is fixed to V<sub>DD</sub>, EV<sub>DD</sub> or V<sub>SS</sub>, EV<sub>SS</sub>. The values below the MAX. column include the peripheral operation current. However, not including the current flowing into the A/D converter, LVD circuit, I/O port, and on-chip pull-up/pull-down resistors and the current flowing during data flash rewrite.
  2. When high-speed on-chip oscillator and subsystem clock are stopped.
  3. When high-speed system clock and subsystem clock are stopped.
  4. When high-speed on-chip oscillator and high-speed system clock are stopped. When AMPHS1 = 1 (Ultra-low power consumption oscillation). However, not including the current flowing into the RTC, 12-bit interval timer, watchdog timer, and LCD controller/driver.
  5. Relationship between operation voltage width, operation frequency of CPU and operation mode is as below.  
HS (high-speed main) mode:  $2.7\text{ V} \leq V_{DD} \leq 5.5\text{ V}@1\text{ MHz to }24\text{ MHz}$   
 $2.4\text{ V} \leq V_{DD} \leq 5.5\text{ V}@1\text{ MHz to }16\text{ MHz}$

- Remarks**
1. f<sub>MX</sub>: High-speed system clock frequency (X1 clock oscillation frequency or external main system clock frequency)
  2. f<sub>IH</sub>: High-speed on-chip oscillator clock frequency
  3. f<sub>SUB</sub>: Subsystem clock frequency (XT1 clock oscillation frequency)
  4. Except subsystem clock operation, temperature condition of the TYP. value is T<sub>A</sub> = 25°C



(T<sub>A</sub> = -40 to +105°C, 2.4 V ≤ EV<sub>DD</sub> = V<sub>DD</sub> ≤ 5.5 V, V<sub>SS</sub> = EV<sub>SS</sub> = 0 V)

(2/3)

| Parameter  | Symbol  | Conditions              |                                     |   |                         | MIN. | TYP.  | MAX. | Unit |
|--|---|-------------------------|-------------------------------------|---|-------------------------|------|-------|------|------|
| Supply current<br>Note 1   | I <sub>DD2</sub><br>Note 2  | HALT mode               | HS (high-speed main) mode<br>Note 7 | f <sub>IH</sub> = 24 MHz<br>Note 4                                | V <sub>DD</sub> = 5.0 V |      | 0.44  | 2.3  | mA   |
|  |   |                         |                                     |   | V <sub>DD</sub> = 3.0 V |      | 0.44  | 2.3  | mA   |
|  |   |                         |                                     | f <sub>IH</sub> = 16 MHz<br>Note 4                                | V <sub>DD</sub> = 5.0 V |      | 0.40  | 1.7  | mA   |
|  |   |                         |                                     |   | V <sub>DD</sub> = 3.0 V |      | 0.40  | 1.7  | mA   |
|  |   |                         | HS (high-speed main) mode<br>Note 7 | f <sub>MX</sub> = 20 MHz<br>Note 3,<br>V <sub>DD</sub> = 5.0 V    | Square wave input       |      | 0.28  | 1.9  | mA   |
|  |   |                         |                                     |   | Resonator connection    |      | 0.45  | 2.0  | mA   |
|  |   |                         |                                     | f <sub>MX</sub> = 20 MHz<br>Note 3,<br>V <sub>DD</sub> = 3.0 V    | Square wave input       |      | 0.28  | 1.9  | mA   |
|  |   |                         |                                     |   | Resonator connection    |      | 0.45  | 2.0  | mA   |
|  |   |                         |                                     | f <sub>MX</sub> = 10 MHz<br>Note 3,<br>V <sub>DD</sub> = 5.0 V    | Square wave input       |      | 0.19  | 1.02 | mA   |
|  |   |                         |                                     |   | Resonator connection    |      | 0.26  | 1.10 | mA   |
|  |   |                         |                                     | f <sub>MX</sub> = 10 MHz<br>Note 3,<br>V <sub>DD</sub> = 3.0 V    | Square wave input       |      | 0.19  | 1.02 | mA   |
|  |   |                         |                                     |   | Resonator connection    |      | 0.26  | 1.10 | mA   |
|  |   |                         | Subsystem clock operation           | f <sub>SUB</sub> = 32.768 kHz<br>Note 5<br>T <sub>A</sub> = -40°C | Square wave input       |      | 0.31  | 0.57 | μA   |
|  |   |                         |                                     |   | Resonator connection    |      | 0.50  | 0.76 | μA   |
|  | f <sub>SUB</sub> = 32.768 kHz<br>Note 5<br>T <sub>A</sub> = +25°C | Square wave input       |                                     |   | 0.37                    | 0.57 | μA    |      |      |
|  |   | Resonator connection    |                                     |   | 0.56                    | 0.76 | μA    |      |      |
|  | f <sub>SUB</sub> = 32.768 kHz<br>Note 5<br>T <sub>A</sub> = +50°C | Square wave input       |                                     |   | 0.46                    | 1.17 | μA    |      |      |
|  |   | Resonator connection    |                                     |   | 0.65                    | 1.36 | μA    |      |      |
|  | f <sub>SUB</sub> = 32.768 kHz<br>Note 5<br>T <sub>A</sub> = +70°C | Square wave input       |                                     |   | 0.57                    | 1.97 | μA    |      |      |
|  |   | Resonator connection    |                                     |   | 0.76                    | 2.16 | μA    |      |      |
| f <sub>SUB</sub> = 32.768 kHz<br>Note 5<br>T <sub>A</sub> = +85°C  | Square wave input   |                         |                                     | 0.85  | 3.37                    | μA   |       |      |      |
|  | Resonator connection  |                         |                                     | 1.04  | 3.56                    | μA   |       |      |      |
| f <sub>SUB</sub> = 32.768 kHz<br>Note 5<br>T <sub>A</sub> = +105°C | Square wave input   |                         | 3.04                                | 15.37   | μA                      |      |       |      |      |
|  | Resonator connection  |                         | 3.23                                | 15.56   | μA                      |      |       |      |      |
| I <sub>DD3</sub><br>Note 6   | STOP mode<br>Note 8   | T <sub>A</sub> = -40°C  |                                     |   |                         | 0.17 | 0.50  | μA   |      |
|  |   | T <sub>A</sub> = +25°C  |                                     |   |                         | 0.23 | 0.50  | μA   |      |
|  |   | T <sub>A</sub> = +50°C  |                                     |   |                         | 0.32 | 1.10  | μA   |      |
|  |   | T <sub>A</sub> = +70°C  |                                     |   |                         | 0.43 | 1.90  | μA   |      |
|  |   | T <sub>A</sub> = +85°C  |                                     |   |                         | 0.71 | 3.30  | μA   |      |
|  |   | T <sub>A</sub> = +105°C |                                     |   |                         | 2.90 | 15.30 | μA   |      |

(Notes and Remarks are listed on the next page.)

- Notes**
1. Total current flowing into  $V_{DD}$  and  $EV_{DD}$ , including the input leakage current flowing when the level of the input pin is fixed to  $V_{DD}$ ,  $EV_{DD}$  or  $V_{SS}$ ,  $EV_{SS}$ . The values below the MAX. column include the peripheral operation current. However, not including the current flowing into the A/D converter, LVD circuit, I/O port, and on-chip pull-up/pull-down resistors and the current flowing during data flash rewrite.
  2. During HALT instruction execution by flash memory.
  3. When high-speed on-chip oscillator and subsystem clock are stopped.
  4. When high-speed system clock and subsystem clock are stopped.
  5. When high-speed on-chip oscillator and high-speed system clock are stopped. When  $RTCLPC = 1$  and setting ultra-low current consumption ( $AMPHS1 = 1$ ). The current flowing into the RTC is included. However, not including the current flowing into the 12-bit interval timer, watchdog timer, and LCD controller/driver.
  6. Not including the current flowing into the RTC, 12-bit interval timer, and watchdog timer.
  7. Relationship between operation voltage width, operation frequency of CPU and operation mode is as below.  
 HS (high-speed main) mode:  $2.7\text{ V} \leq V_{DD} \leq 5.5\text{ V}@1\text{ MHz to }24\text{ MHz}$   
 $2.4\text{ V} \leq V_{DD} \leq 5.5\text{ V}@1\text{ MHz to }16\text{ MHz}$
  8. Regarding the value for current operate the subsystem clock in STOP mode, refer to that in HALT mode.

- Remarks**
1.  $f_{MX}$ : High-speed system clock frequency (X1 clock oscillation frequency or external main system clock frequency)
  2.  $f_{IH}$ : High-speed on-chip oscillator clock frequency
  3.  $f_{SUB}$ : Subsystem clock frequency (XT1 clock oscillation frequency)
  4. Except subsystem clock operation and STOP mode, temperature condition of the TYP. value is  $T_A = 25^\circ\text{C}$

(T<sub>A</sub> = -40 to +105°C, 2.4 V ≤ EV<sub>DD</sub> = V<sub>DD</sub> ≤ 5.5 V, V<sub>SS</sub> = EV<sub>SS</sub> = 0 V)

(3/3)

| Parameter                                      | Symbol                                       | Conditions                          |   | MIN.   | TYP.  | MAX.  | Unit |
|--|--|-------------------------------------|---|--|---|-------|------|
| Low-speed on-chip oscillator operating current | I <sub>FIL</sub> <sup>Note 1</sup>           |                                     |   |  | 0.20  |       | μA   |
| RTC operating current                          | I <sub>RTC</sub><br><sup>Notes 1, 2, 3</sup> | f <sub>MAIN</sub> is stopped        |   |  | 0.08  |       | μA   |
| 12-bit interval timer current                  | I <sub>IT</sub><br><sup>Notes 1, 2, 4</sup>  |                                     |   |  | 0.08  |       | μA   |
| Watchdog timer operating current               | I <sub>WDT</sub><br><sup>Notes 1, 2, 5</sup> | f <sub>IL</sub> = 15 kHz            |   |  | 0.24  |       | μA   |
| A/D converter operating current                | I <sub>ADC</sub><br><sup>Notes 1, 6</sup>    | When conversion at maximum speed    | Normal mode, AV <sub>REFP</sub> = V <sub>DD</sub> = 5.0 V   |  | 1.3   | 1.7   | mA   |
|  |  |                                     | Low voltage mode, AV <sub>REFP</sub> = V <sub>DD</sub> = 3.0 V  |  | 0.5   | 0.7   | mA   |
| A/D converter reference voltage current        | I <sub>ADREF</sub><br><sup>Note 1</sup>      |                                     |   |  | 75.0  |       | μA   |
| Temperature sensor operating current           | I <sub>TMPS</sub><br><sup>Note 1</sup>       |                                     |   |  | 75.0  |       | μA   |
| LVD operating current                          | I <sub>LVD</sub><br><sup>Notes 1, 7</sup>    |                                     |   |  | 0.08  |       | μA   |
| Self-programming operating current             | I <sub>FSP</sub><br><sup>Notes 1, 9</sup>    |                                     |   |  | 2.50  | 12.20 | mA   |
| BGO operating current                          | I <sub>BGO</sub><br><sup>Notes 1, 8</sup>    |                                     |   |  | 2.50  | 12.20 | mA   |
| LCD operating current                          | I <sub>LCD1</sub><br><sup>Notes 11, 12</sup> | External resistance division method | V <sub>DD</sub> = EV <sub>DD</sub> = 5.0 V<br>V <sub>L4</sub> = 5.0 V                                       |  | 0.04  | 0.20  | μA   |
|  |  |                                     | Internal voltage boosting method  | V <sub>DD</sub> = EV <sub>DD</sub> = 5.0 V<br>V <sub>L4</sub> = 5.1 V (VLCD = 12H) |   | 1.12  | 3.70 |
|  | I <sub>LCD2</sub><br><sup>Note 11</sup>      |                                     |   | V <sub>DD</sub> = EV <sub>DD</sub> = 3.0 V<br>V <sub>L4</sub> = 3.0 V (VLCD = 04H) |   | 0.63  | 2.20 |
|  |  |                                     | I <sub>LCD3</sub> <sup>Note 11</sup>  | Capacitor split method   | V <sub>DD</sub> = EV <sub>DD</sub> = 3.0 V<br>V <sub>L4</sub> = 3.0 V |       | 0.12 |
| SNOOZE operating current                       | I <sub>SNOZ</sub> <sup>Note 1</sup>          | ADC operation                       | The mode is performed <sup>Note 10</sup>  |  | 0.50  | 1.10  | mA   |
|  |  |                                     | The A/D conversion operations are performed, Low voltage mode, AV <sub>REFP</sub> = V <sub>DD</sub> = 3.0 V |  | 1.20  | 2.04  | mA   |
|  |  | CSI/UART operation                  |   | 0.70   | 1.54  | mA    |      |

(Notes and Remarks are listed on the next page.)

- Notes**
1. Current flowing to  $V_{DD}$ .
  2. When high speed on-chip oscillator and high-speed system clock are stopped.
  3. Current flowing only to the real-time clock (RTC) (excluding the operating current of the low-speed on-chip oscillator and the XT1 oscillator). The supply current of the RL78 microcontrollers is the sum of the values of either  $I_{DD1}$  or  $I_{DD2}$ , and  $I_{RTC}$ , when the real-time clock operates in operation mode or HALT mode. When the low-speed on-chip oscillator is selected,  $I_{FIL}$  should be added.  $I_{DD2}$  subsystem clock operation includes the operational current of the real-time clock.
  4. Current flowing only to the 12-bit interval timer (excluding the operating current of the low-speed on-chip oscillator and the XT1 oscillator). The supply current of the RL78 microcontrollers is the sum of the values of either  $I_{DD1}$  or  $I_{DD2}$ , and  $I_{IT}$ , when the 12-bit interval timer operates in operation mode or HALT mode. When the low-speed on-chip oscillator is selected,  $I_{FIL}$  should be added.
  5. Current flowing only to the watchdog timer (including the operating current of the low-speed on-chip oscillator). The supply current of the RL78 microcontrollers is the sum of  $I_{DD1}$ ,  $I_{DD2}$  or  $I_{DD3}$  and  $I_{WDT}$  when the watchdog timer is in operation.
  6. Current flowing only to the A/D converter. The supply current of the RL78 microcontrollers is the sum of  $I_{DD1}$  or  $I_{DD2}$  and  $I_{ADC}$  when the A/D converter operates in an operation mode or the HALT mode.
  7. Current flowing only to the LVD circuit. The supply current of the RL78 microcontrollers is the sum of  $I_{DD1}$ ,  $I_{DD2}$  or  $I_{DD3}$  and  $I_{LVD}$  when the LVD circuit is in operation.
  8. Current flowing only during data flash rewrite.
  9. Current flowing only during self programming.
  10. For shift time to the SNOOZE mode.
  11. Current flowing only to the LCD controller/driver. The supply current value of the RL78 microcontrollers is the sum of the LCD operating current ( $I_{LCD1}$ ,  $I_{LCD2}$  or  $I_{LCD3}$ ) to the supply current ( $I_{DD1}$  or  $I_{DD2}$ ) when the LCD controller/driver operates in an operation mode or HALT mode. Not including the current that flows through the LCD panel.  
The TYP. value and MAX. value are following conditions.
    - When  $f_{SUB}$  is selected for system clock, LCD clock = 128 Hz (LCDC0 = 07H)
    - 4-Time-Slice, 1/3 Bias Method
  12. Not including the current that flows through the external divider resistor when the external resistance division method is used.

- Remarks**
1.  $f_{IL}$ : Low-speed on-chip oscillator clock frequency
  2.  $f_{SUB}$ : Subsystem clock frequency (XT1 clock oscillation frequency)
  3.  $f_{CLK}$ : CPU/peripheral hardware clock frequency
  4. Temperature condition of the TYP. value is  $T_A = 25^\circ\text{C}$

## 3.4 AC Characteristics

## 3.4.1 Basic operation

(T<sub>A</sub> = -40 to +105°C, 2.4 V ≤ EV<sub>DD</sub> = V<sub>DD</sub> ≤ 5.5 V, V<sub>SS</sub> = EV<sub>SS</sub> = 0 V)

| Items   | Symbol                                | Conditions                                       |                                  | MIN.                            | TYP.    | MAX. | Unit |    |
|---|---------------------------------------|--|----------------------------------|---------------------------------|---------|------|------|----|
| Instruction cycle (minimum instruction execution time)        | T <sub>CY</sub>                       | Main system clock (f <sub>MAIN</sub> ) operation | HS (high-speed main) mode        | 2.7 V ≤ V <sub>DD</sub> ≤ 5.5 V | 0.04167 |      | 1    | μs |
|   |                                       |  |                                  | 2.4 V ≤ V <sub>DD</sub> < 2.7 V | 0.0625  |      | 1    | μs |
|   |                                       | Subsystem clock (f <sub>SUB</sub> ) operation    |                                  | 2.4 V ≤ V <sub>DD</sub> ≤ 5.5 V | 28.5    | 30.5 | 31.3 | μs |
|   |                                       | In the self programming mode                     | HS (high-speed main) mode        | 2.7 V ≤ V <sub>DD</sub> ≤ 5.5 V | 0.04167 |      | 1    | μs |
|   | 2.4 V ≤ V <sub>DD</sub> < 2.7 V       |  | 0.0625                           |                                 | 1       | μs   |      |    |
| External system clock frequency                               | f <sub>EX</sub>                       | 2.7 V ≤ V <sub>DD</sub> ≤ 5.5 V                  |                                  | 1.0                             |         | 20.0 | MHz  |    |
|   |                                       | 2.4 V ≤ V <sub>DD</sub> < 2.7 V                  |                                  | 1.0                             |         | 16.0 | MHz  |    |
|   | f <sub>EXS</sub>                      |  |                                  | 32                              |         | 35   | kHz  |    |
| External system clock input high-level width, low-level width | t <sub>EXH</sub> , t <sub>EXL</sub>   | 2.7 V ≤ V <sub>DD</sub> ≤ 5.5 V                  |                                  | 24                              |         |      | ns   |    |
|   |                                       | 2.4 V ≤ V <sub>DD</sub> < 2.7 V                  |                                  | 30                              |         |      | ns   |    |
|   | t <sub>EXHS</sub> , t <sub>EXLS</sub> |  |                                  | 13.7                            |         |      | μs   |    |
| TI00 to TI07 input high-level width, low-level width          | t <sub>TIH</sub> , t <sub>TIL</sub>   |  |                                  | 1/f <sub>MCK</sub> +10          |         |      | ns   |    |
| TO00 to TO07 output frequency                                 | f <sub>TO</sub>                       | HS (high-speed main) mode                        | 4.0 V ≤ EV <sub>DD</sub> ≤ 5.5 V |                                 |         | 16   | MHz  |    |
|   |                                       |  | 2.7 V ≤ EV <sub>DD</sub> < 4.0 V |                                 |         | 8    | MHz  |    |
|   |                                       |  | 2.4 V ≤ EV <sub>DD</sub> < 2.7 V |                                 |         | 4    | MHz  |    |
| PCLBUZ0, PCLBUZ1 output frequency                             | f <sub>PCL</sub>                      | HS (high-speed main) mode                        | 4.0 V ≤ EV <sub>DD</sub> ≤ 5.5 V |                                 |         | 16   | MHz  |    |
|   |                                       |  | 2.7 V ≤ EV <sub>DD</sub> < 4.0 V |                                 |         | 8    | MHz  |    |
|   |                                       |  | 2.4 V ≤ EV <sub>DD</sub> < 2.7 V |                                 |         | 4    | MHz  |    |
| Interrupt input high-level width, low-level width             | t <sub>INTH</sub> , t <sub>INTL</sub> | INTP0  | 2.4 V ≤ V <sub>DD</sub> ≤ 5.5 V  | 1                               |         |      | μs   |    |
|   |                                       | INTP1 to INTP7                                   | 2.4 V ≤ V <sub>DD</sub> ≤ 5.5 V  | 1                               |         |      | μs   |    |
| Key interrupt input low-level width                           | t <sub>KR</sub>                       | KR0 to KR3                                       | 2.4 V ≤ EV <sub>DD</sub> ≤ 5.5 V | 250                             |         |      | ns   |    |
| RESET low-level width   | t <sub>RSL</sub>                      |  |                                  | 10                              |         |      | μs   |    |

**Remark** f<sub>MCK</sub>: Timer array unit operation clock frequency

(Operation clock to be set by the CKS0n bit of timer mode register 0n (TMR0n).

n: Channel number (n = 0 to 7))

**Minimum Instruction Execution Time during Main System Clock Operation**

T<sub>CY</sub> vs V<sub>DD</sub> (HS (high-speed main) mode)

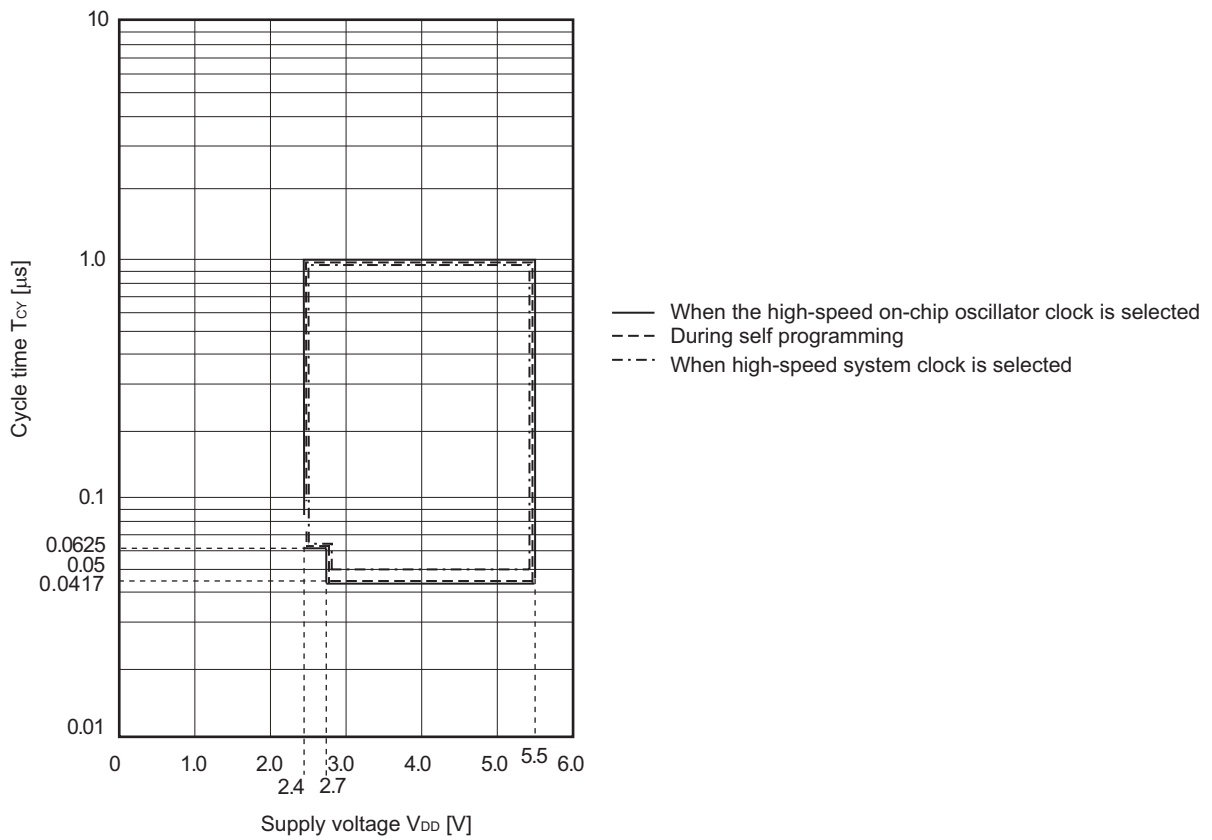

**AC Timing Test Points**

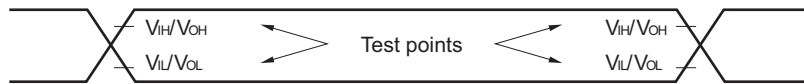

**External System Clock Timing**

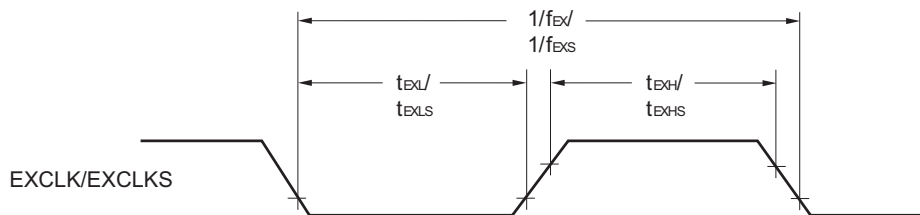

**TI/TO Timing**

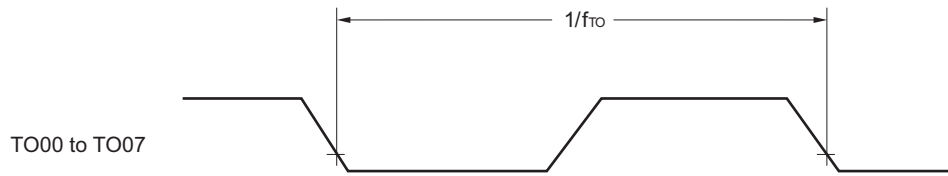
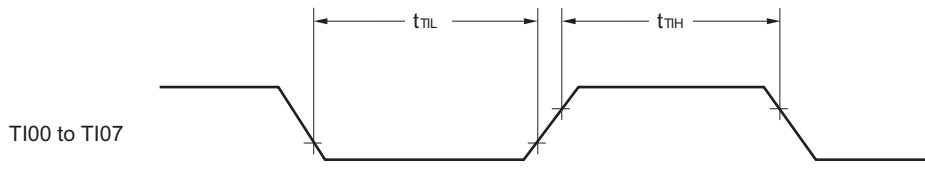

**Interrupt Request Input Timing**

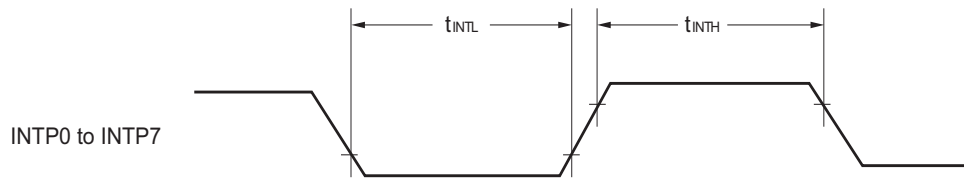

**Key Interrupt Input Timing**

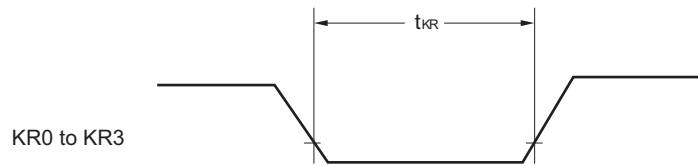

**RESET Input Timing**

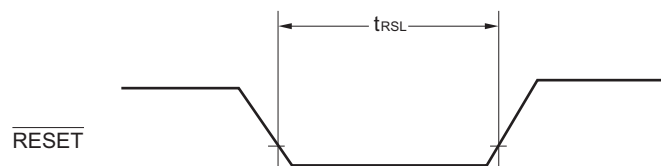

### 3.5 Peripheral Functions Characteristics

#### AC Timing Test Points



#### 3.5.1 Serial array unit

##### (1) During communication at same potential (UART mode)

(T<sub>A</sub> = -40 to +105°C, 2.4 V ≤ EV<sub>DD</sub> = V<sub>DD</sub> ≤ 5.5 V, V<sub>SS</sub> = EV<sub>SS</sub> = 0 V)

| Parameter                       | Symbol | Conditions  | HS (high-speed main) Mode |              | Unit |
|---------------------------------|--------|---|---------------------------|--------------|------|
|                                 |        |   | MIN.                      | MAX.         |      |
| Transfer rate <sup>Note 1</sup> |        | Theoretical value of the maximum transfer rate<br>$f_{MCK} = f_{CLK}$ <sup>Note 2</sup> |                           | $f_{MCK}/12$ | bps  |
|                                 |        |   |                           | 2.0          | Mbps |

**Notes 1.** Transfer rate in the SNOOZE mode is 4800 bps only.

**2.** The maximum operating frequencies of the CPU/peripheral hardware clock (f<sub>CLK</sub>) are:

HS (high-speed main) mode: 24 MHz (2.7 V ≤ V<sub>DD</sub> ≤ 5.5 V)

16 MHz (2.4 V ≤ V<sub>DD</sub> ≤ 5.5 V)

**Caution** Select the normal input buffer for the Rx<sub>Dq</sub> pin and the normal output mode for the Tx<sub>Dq</sub> pin by using port input mode register g (PIMg) and port output mode register g (POMg).

#### UART mode connection diagram (during communication at same potential)

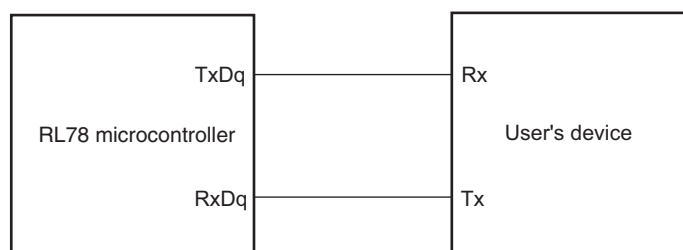

#### UART mode bit width (during communication at same potential) (reference)

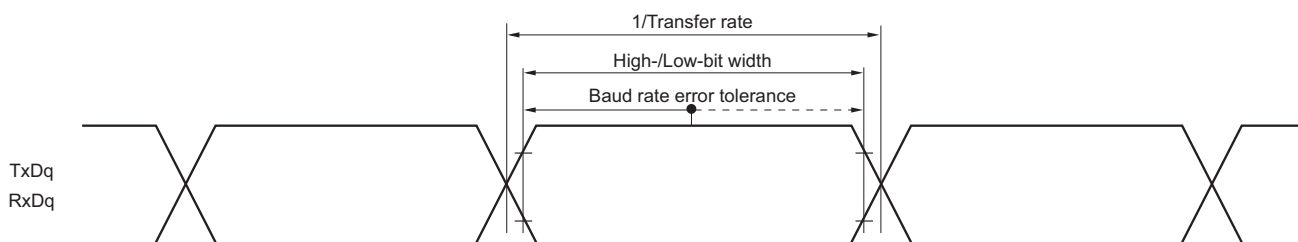

**Remarks 1.** q: UART number (q = 0), g: PIM and POM number (g = 1)

**2.** f<sub>MCK</sub>: Serial array unit operation clock frequency

(Operation clock to be set by the serial clock select register m (SPSm) and the CKSmn bit of serial mode register mn (SMRmn). m: Unit number, n: Channel number (mn = 00, 01))



**(2) During communication at same potential (CSI mode) (master mode, SCKp... internal clock output)****(T<sub>A</sub> = -40 to +105°C, 2.4 V ≤ EV<sub>DD</sub> = V<sub>DD</sub> ≤ 5.5 V, V<sub>SS</sub> = EV<sub>SS</sub> = 0 V)**

| Parameter   | Symbol                                 | Conditions                       | HS (high-speed main) Mode        |      | Unit |
|---|--|----------------------------------|----------------------------------|------|------|
|   |  |                                  | MIN.                             | MAX. |      |
| SCKp cycle time                                       | t <sub>KCY1</sub>                      | 2.7 V ≤ EV <sub>DD</sub> ≤ 5.5 V | 334 <sup>Note 1</sup>            |      | ns   |
|   |  | 2.4 V ≤ EV <sub>DD</sub> ≤ 5.5 V | 500 <sup>Note 1</sup>            |      | ns   |
| SCKp high-/low-level width                            | t <sub>KH1</sub> ,<br>t <sub>KL1</sub> | 4.0 V ≤ EV <sub>DD</sub> ≤ 5.5 V | t <sub>KCY1</sub> /2 - 24        |      | ns   |
|   |  | 2.7 V ≤ EV <sub>DD</sub> ≤ 5.5 V | t <sub>KCY1</sub> /2 - 36        |      | ns   |
|   |  | 2.4 V ≤ EV <sub>DD</sub> ≤ 5.5 V | t <sub>KCY1</sub> /2 - 76        |      | ns   |
| Slp setup time (to SCKp↑) <sup>Note 2</sup>           | t <sub>SIK1</sub>                      | 2.7 V ≤ EV <sub>DD</sub> ≤ 5.5 V | 66                               |      | ns   |
|   |  | 2.4 V ≤ EV <sub>DD</sub> ≤ 5.5 V | 113                              |      | ns   |
| Slp hold time (from SCKp↑) <sup>Note 3</sup>          | t <sub>KSI1</sub>                      | 2.4 V ≤ EV <sub>DD</sub> ≤ 5.5 V | 38                               |      | ns   |
| Delay time from SCKp↓ to SOp output <sup>Note 4</sup> | t <sub>KSO1</sub>                      | C = 30 pF <sup>Note 5</sup>      | 2.4 V ≤ EV <sub>DD</sub> ≤ 5.5 V | 50   | ns   |

**Notes** 1. Set a cycle of 4/f<sub>MCK</sub> or longer.2. When DAP<sub>mn</sub> = 0 and CKP<sub>mn</sub> = 0, or DAP<sub>mn</sub> = 1 and CKP<sub>mn</sub> = 1. The Slp setup time becomes “to SCKp↓” when DAP<sub>mn</sub> = 0 and CKP<sub>mn</sub> = 1, or DAP<sub>mn</sub> = 1 and CKP<sub>mn</sub> = 0.3. When DAP<sub>mn</sub> = 0 and CKP<sub>mn</sub> = 0, or DAP<sub>mn</sub> = 1 and CKP<sub>mn</sub> = 1. The Slp hold time becomes “from SCKp↓” when DAP<sub>mn</sub> = 0 and CKP<sub>mn</sub> = 1, or DAP<sub>mn</sub> = 1 and CKP<sub>mn</sub> = 0.4. When DAP<sub>mn</sub> = 0 and CKP<sub>mn</sub> = 0, or DAP<sub>mn</sub> = 1 and CKP<sub>mn</sub> = 1. The delay time to SOp output becomes “from SCKp↑” when DAP<sub>mn</sub> = 0 and CKP<sub>mn</sub> = 1, or DAP<sub>mn</sub> = 1 and CKP<sub>mn</sub> = 0.

5. C is the load capacitance of the SCKp and SOp output lines.

**Caution** Select the normal input buffer for the Slp pin and the normal output mode for the SOp pin and SCKp pin by using port input mode register g (PIMg) and port output mode register g (POMg).**Remarks** 1. p: CSI number (p = 00, 01), m: Unit number (m = 0), n: Channel number (n = 0, 1),  
g: PIM and POM numbers (g = 1)2. f<sub>MCK</sub>: Serial array unit operation clock frequency  
(Operation clock to be set by the serial clock select register m (SPSm) and the CKS<sub>mn</sub> bit of serial mode register mn (SMR<sub>mn</sub>). m: Unit number, n: Channel number (mn = 00, 01))

**(3) During communication at same potential (CSI mode) (slave mode, SCKp... external clock input)**  
 (T<sub>A</sub> = -40 to +105°C, 2.4 V ≤ EV<sub>DD</sub> = V<sub>DD</sub> ≤ 5.5 V, V<sub>SS</sub> = EV<sub>SS</sub> = 0 V)

| Parameter   | Symbol                                 | Conditions                       |                                  | HS (high-speed main) Mode    |                          | Unit |
|---|--|----------------------------------|----------------------------------|------------------------------|--------------------------|------|
|   |  |                                  |                                  | MIN.                         | MAX.                     |      |
| SCKp cycle time <sup>Note 5</sup>                     | t <sub>KCY2</sub>                      | 4.0 V ≤ EV <sub>DD</sub> ≤ 5.5 V | 20 MHz < f <sub>MCK</sub>        | 16/f <sub>MCK</sub>          |                          | ns   |
|   |  |                                  | f <sub>MCK</sub> ≤ 20 MHz        | 12/f <sub>MCK</sub>          |                          | ns   |
|   |  | 2.7 V ≤ EV <sub>DD</sub> < 4.0 V | 16 MHz < f <sub>MCK</sub>        | 16/f <sub>MCK</sub>          |                          | ns   |
|   |  |                                  | f <sub>MCK</sub> ≤ 16 MHz        | 12/f <sub>MCK</sub>          |                          | ns   |
|   |  | 2.4 V ≤ EV <sub>DD</sub> ≤ 5.5 V |                                  | 12/f <sub>MCK</sub> and 1000 |                          | ns   |
| SCKp high-/low-level width                            | t <sub>KH2</sub> ,<br>t <sub>KL2</sub> | 4.0 V ≤ EV <sub>DD</sub> ≤ 5.5 V |                                  | t <sub>KCY2</sub> /2 - 14    |                          | ns   |
|   |  | 2.7 V ≤ EV <sub>DD</sub> < 4.0 V |                                  | t <sub>KCY2</sub> /2 - 16    |                          | ns   |
|   |  | 2.4 V ≤ EV <sub>DD</sub> < 2.7 V |                                  | t <sub>KCY2</sub> /2 - 36    |                          | ns   |
| Slp setup time (to SCKp↑) <sup>Note 1</sup>           | t <sub>SIK2</sub>                      | 2.7 V ≤ EV <sub>DD</sub> ≤ 5.5 V |                                  | 1/f <sub>MCK</sub> + 40      |                          | ns   |
|   |  | 2.4 V ≤ EV <sub>DD</sub> < 2.7 V |                                  | 1/f <sub>MCK</sub> + 60      |                          | ns   |
| Slp hold time (from SCKp↑) <sup>Note 2</sup>          | t <sub>KSI2</sub>                      | 2.4 V ≤ EV <sub>DD</sub> ≤ 5.5 V |                                  | 1/f <sub>MCK</sub> + 62      |                          | ns   |
| Delay time from SCKp↓ to SOp output <sup>Note 3</sup> | t <sub>KSO2</sub>                      | C = 30 pF <sup>Note 4</sup>      | 4.0 V ≤ EV <sub>DD</sub> ≤ 5.5 V |                              | 2/f <sub>MCK</sub> + 66  | ns   |
|   |  |                                  | 2.7 V ≤ EV <sub>DD</sub> < 4.0 V |                              | 2/f <sub>MCK</sub> + 66  | ns   |
|   |  |                                  | 2.4 V ≤ EV <sub>DD</sub> < 2.7 V |                              | 2/f <sub>MCK</sub> + 113 | Ns   |

- Notes**
1. When DAP<sub>mn</sub> = 0 and CKP<sub>mn</sub> = 0, or DAP<sub>mn</sub> = 1 and CKP<sub>mn</sub> = 1. The Slp setup time becomes “to SCKp↓” when DAP<sub>mn</sub> = 0 and CKP<sub>mn</sub> = 1, or DAP<sub>mn</sub> = 1 and CKP<sub>mn</sub> = 0.
  2. When DAP<sub>mn</sub> = 0 and CKP<sub>mn</sub> = 0, or DAP<sub>mn</sub> = 1 and CKP<sub>mn</sub> = 1. The Slp hold time becomes “from SCKp↓” when DAP<sub>mn</sub> = 0 and CKP<sub>mn</sub> = 1, or DAP<sub>mn</sub> = 1 and CKP<sub>mn</sub> = 0.
  3. When DAP<sub>mn</sub> = 0 and CKP<sub>mn</sub> = 0, or DAP<sub>mn</sub> = 1 and CKP<sub>mn</sub> = 1. The delay time to SOp output becomes “from SCKp↑” when DAP<sub>mn</sub> = 0 and CKP<sub>mn</sub> = 1, or DAP<sub>mn</sub> = 1 and CKP<sub>mn</sub> = 0.
  4. C is the load capacitance of the SOp output lines.
  5. Transfer rate in the SNOOZE mode : MAX. 1 Mbps

**Caution** Select the normal input buffer for the Slp pin and SCKp pin and the normal output mode for the SOp pin by using port input mode register g (PIMg) and port output mode register g (POMg).

- Remarks**
1. p: CSI number (p = 00, 01), m: Unit number (m = 0), n: Channel number (n = 0, 1), g: PIM number (g = 1)
  2. f<sub>MCK</sub>: Serial array unit operation clock frequency  
 (Operation clock to be set by the serial clock select register m (SPSm) and the CKSmn bit of serial mode register mn (SMRmn). m: Unit number, n: Channel number (mn = 00, 01))

**CSI mode connection diagram (during communication at same potential)**

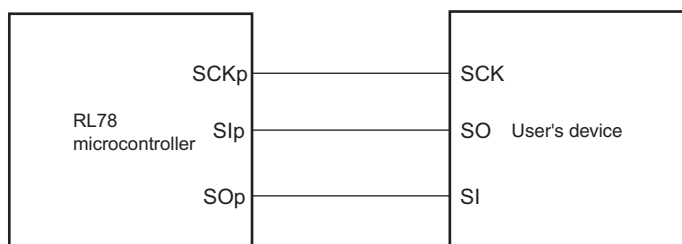

**CSI mode serial transfer timing (during communication at same potential)**  
**(When DAPmn = 0 and CKPmn = 0, or DAPmn = 1 and CKPmn = 1.)**

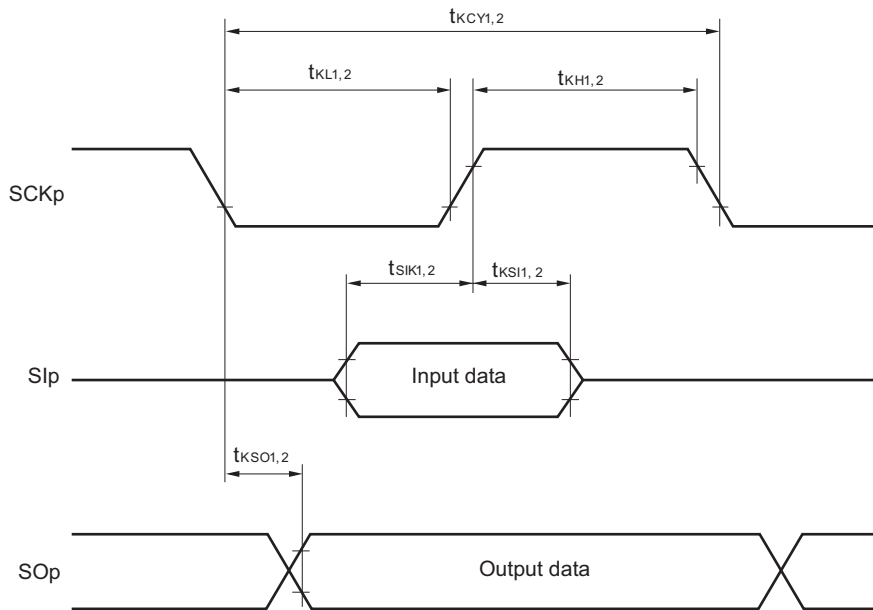

**CSI mode serial transfer timing (during communication at same potential)**  
**(When DAPmn = 0 and CKPmn = 1, or DAPmn = 1 and CKPmn = 0.)**

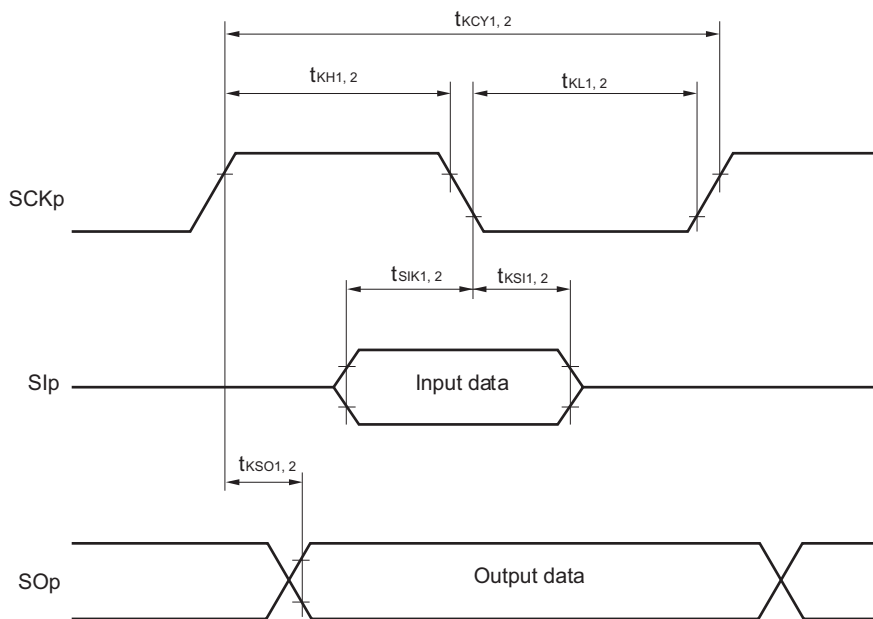

- Remarks**
1. p: CSI number (p = 00, 01)
  2. m: Unit number, n: Channel number (mn = 00, 01)

**(4) Communication at different potential (1.8 V, 2.5 V, 3 V) (UART mode) (1/2)****(T<sub>A</sub> = -40 to +105°C, 2.4 V ≤ EV<sub>DD</sub> = V<sub>DD</sub> ≤ 5.5 V, V<sub>SS</sub> = EV<sub>SS</sub> = 0 V)**

| Parameter     | Symbol | Conditions | HS (high-speed main) Mode   |   | Unit                                   |     |
|---------------|--------|------------|---|---|--|-----|
|               |        |            | MIN.  | MAX.  |  |     |
| Transfer rate |        | Reception  | 4.0 V ≤ EV <sub>DD</sub> ≤ 5.5 V,<br>2.7 V ≤ V <sub>b</sub> ≤ 4.0 V |   | f <sub>MCK</sub> /12 <sup>Note 1</sup> | bps |
|               |        |            |   | Theoretical value of the maximum transfer rate<br>f <sub>MCK</sub> = f <sub>CLK</sub> <sup>Note 2</sup> |  | 2.0 |
|               |        |            | 2.7 V ≤ EV <sub>DD</sub> < 4.0 V,<br>2.3 V ≤ V <sub>b</sub> ≤ 2.7 V |   | f <sub>MCK</sub> /12 <sup>Note 1</sup> | bps |
|               |        |            |   | Theoretical value of the maximum transfer rate<br>f <sub>MCK</sub> = f <sub>CLK</sub> <sup>Note 2</sup> |  | 2.0 |
|               |        |            | 2.4 V ≤ EV <sub>DD</sub> < 3.3 V,<br>1.6 V ≤ V <sub>b</sub> ≤ 2.0 V |   | f <sub>MCK</sub> /12 <sup>Note 1</sup> | bps |
|               |        |            |   | Theoretical value of the maximum transfer rate<br>f <sub>MCK</sub> = f <sub>CLK</sub> <sup>Note 2</sup> |  | 2.0 |

**Notes 1.** Transfer rate in the SNOOZE mode is 4800 bps only.**2.** The maximum operating frequencies of the CPU/peripheral hardware clock (f<sub>CLK</sub>) are:HS (high-speed main) mode: 24 MHz (2.7 V ≤ V<sub>DD</sub> ≤ 5.5 V)16 MHz (2.4 V ≤ V<sub>DD</sub> ≤ 5.5 V)

**Caution** Select the TTL input buffer for the RxDq pin and the N-ch open drain output (V<sub>DD</sub> tolerance (32- to 52-pin products)/EV<sub>DD</sub> tolerance (64-pin products)) mode for the TxDq pin by using port input mode register g (PIMg) and port output mode register g (POMg). For V<sub>IH</sub> and V<sub>IL</sub>, see the DC characteristics with TTL input buffer selected.

**Remarks 1.** V<sub>b</sub>[V]: Communication line voltage**2.** q: UART number (q = 0), g: PIM and POM number (g = 1)**3.** f<sub>MCK</sub>: Serial array unit operation clock frequency

(Operation clock to be set by the serial clock select register m (SPSm) and the CKSmn bit of serial mode register mn (SMRmn). m: Unit number, n: Channel number (mn = 00, 01))

**(4) Communication at different potential (1.8 V, 2.5 V, 3 V) (UART mode)****(2/2)****(T<sub>A</sub> = -40 to +105°C, 2.4 V ≤ EV<sub>DD</sub> = V<sub>DD</sub> ≤ 5.5 V, V<sub>SS</sub> = EV<sub>SS</sub> = 0 V)**

| Parameter     | Symbol | Conditions  | HS (high-speed main) Mode   |               | Unit                   |      |
|---------------|--------|---|---|---------------|------------------------|------|
|               |        |   | MIN.  | MAX.          |                        |      |
| Transfer rate |        | Transmission  | 4.0 V ≤ EV <sub>DD</sub> ≤ 5.5 V,<br>2.7 V ≤ V <sub>b</sub> ≤ 4.0 V   |               | <b>Note 1</b>          | bps  |
|               |        |   | Theoretical value of the maximum transfer rate<br>C <sub>b</sub> = 50 pF, R <sub>b</sub> = 1.4 kΩ, V <sub>b</sub> = 2.7 V |               | 2.0 <sup>Note 2</sup>  | Mbps |
|               |        | 2.7 V ≤ EV <sub>DD</sub> < 4.0 V,<br>2.3 V ≤ V <sub>b</sub> ≤ 2.7 V |   | <b>Note 3</b> | bps                    |      |
|               |        |   | Theoretical value of the maximum transfer rate<br>C <sub>b</sub> = 50 pF, R <sub>b</sub> = 2.7 kΩ, V <sub>b</sub> = 2.3 V |               | 1.2 <sup>Note 4</sup>  | Mbps |
|               |        | 2.4 V ≤ EV <sub>DD</sub> < 3.3 V,<br>1.6 V ≤ V <sub>b</sub> ≤ 2.0 V |   | <b>Note 5</b> | bps                    |      |
|               |        |   | Theoretical value of the maximum transfer rate<br>C <sub>b</sub> = 50 pF, R <sub>b</sub> = 5.5 kΩ, V <sub>b</sub> = 1.6 V |               | 0.43 <sup>Note 6</sup> | Mbps |

**Notes 1.** The smaller maximum transfer rate derived by using  $f_{MCK}/6$  or the following expression is the valid maximum transfer rate.

Expression for calculating the transfer rate when 4.0 V ≤ EV<sub>DD</sub> ≤ 5.5 V and 2.7 V ≤ V<sub>b</sub> ≤ 4.0 V

$$\text{Maximum transfer rate} = \frac{1}{\{-C_b \times R_b \times \ln(1 - \frac{2.2}{V_b})\} \times 3} \text{ [bps]}$$

$$\text{Baud rate error (theoretical value)} = \frac{\frac{1}{\text{Transfer rate} \times 2} - \{-C_b \times R_b \times \ln(1 - \frac{2.2}{V_b})\}}{(\frac{1}{\text{Transfer rate}}) \times \text{Number of transferred bits}} \times 100 \text{ [%]}$$

\* This value is the theoretical value of the relative difference between the transmission and reception sides.

**2.** This value as an example is calculated when the conditions described in the “Conditions” column are met. Refer to Note 1 above to calculate the maximum transfer rate under conditions of the customer.

**3.** The smaller maximum transfer rate derived by using  $f_{MCK}/6$  or the following expression is the valid maximum transfer rate.

Expression for calculating the transfer rate when 2.7 V ≤ EV<sub>DD</sub> < 4.0 V and 2.3 V ≤ V<sub>b</sub> ≤ 2.7 V

$$\text{Maximum transfer rate} = \frac{1}{\{-C_b \times R_b \times \ln(1 - \frac{2.0}{V_b})\} \times 3} \text{ [bps]}$$

$$\text{Baud rate error (theoretical value)} = \frac{\frac{1}{\text{Transfer rate} \times 2} - \{-C_b \times R_b \times \ln(1 - \frac{2.0}{V_b})\}}{(\frac{1}{\text{Transfer rate}}) \times \text{Number of transferred bits}} \times 100 \text{ [%]}$$

\* This value is the theoretical value of the relative difference between the transmission and reception sides.

**4.** This value as an example is calculated when the conditions described in the “Conditions” column are met. Refer to Note 3 above to calculate the maximum transfer rate under conditions of the customer.

5. The smaller maximum transfer rate derived by using  $f_{MCK}/6$  or the following expression is the valid maximum transfer rate.

Expression for calculating the transfer rate when  $1.8\text{ V} \leq EV_{DD} < 3.3\text{ V}$  and  $1.6\text{ V} \leq V_b \leq 2.0\text{ V}$

$$\text{Maximum transfer rate} = \frac{1}{\{-C_b \times R_b \times \ln(1 - \frac{1.5}{V_b})\} \times 3} \text{ [bps]}$$

$$\text{Baud rate error (theoretical value)} = \frac{\frac{1}{\text{Transfer rate} \times 2} - \{-C_b \times R_b \times \ln(1 - \frac{1.5}{V_b})\}}{(\frac{1}{\text{Transfer rate}}) \times \text{Number of transferred bits}} \times 100 \text{ [%]}$$

\* This value is the theoretical value of the relative difference between the transmission and reception sides.

6. This value as an example is calculated when the conditions described in the "Conditions" column are met. Refer to Note 5 above to calculate the maximum transfer rate under conditions of the customer.

**Caution** Select the TTL input buffer for the RxDq pin and the N-ch open drain output (V<sub>DD</sub> tolerance (32- to 52-pin products)/EV<sub>DD</sub> tolerance (64-pin products)) mode for the TxDq pin by using port input mode register g (PIMg) and port output mode register g (POMg). For V<sub>IH</sub> and V<sub>IL</sub>, see the DC characteristics with TTL input buffer selected.

UART mode connection diagram (during communication at different potential)

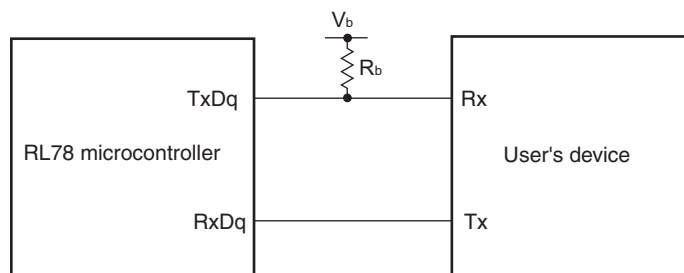

### UART mode bit width (during communication at different potential) (reference)

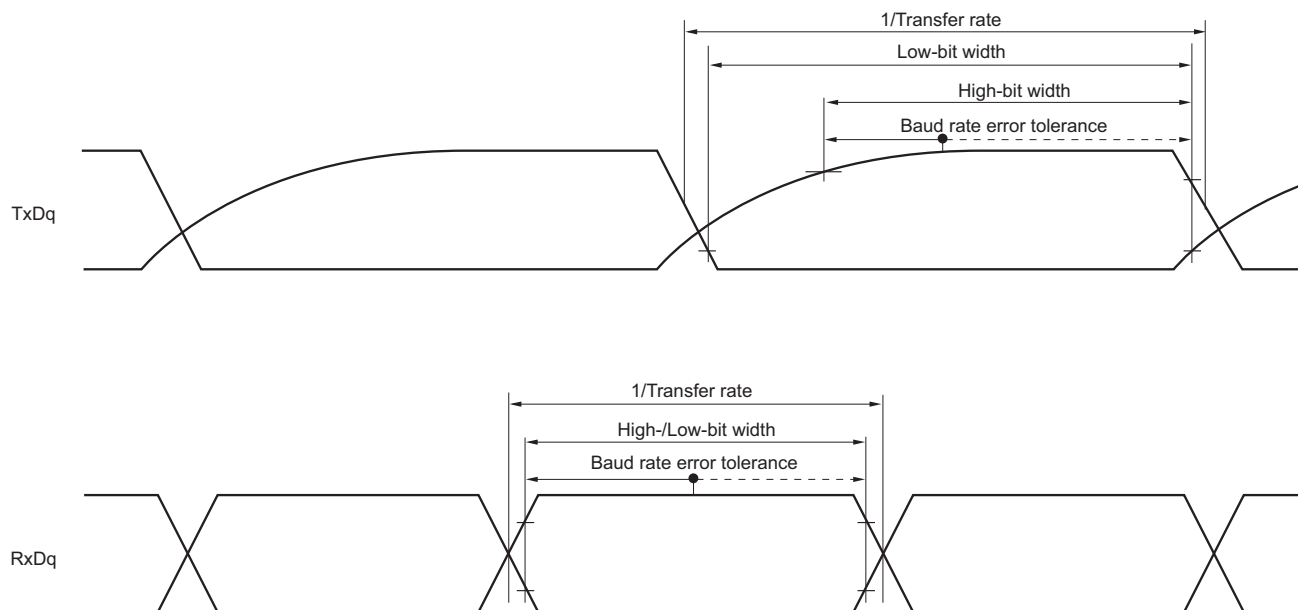

- Remarks 1.**  $R_b[\Omega]$ : Communication line (TxDq) pull-up resistance,  
 $C_b[\text{F}]$ : Communication line (TxDq) load capacitance,  $V_b[\text{V}]$ : Communication line voltage
- 2.** q: UART number (q = 0, 1), g: PIM and POM number (g = 1)
- 3.**  $f_{\text{MCK}}$ : Serial array unit operation clock frequency  
 (Operation clock to be set by the serial clock select register m (SPSm) and the CKSmn bit of serial mode register mn (SMRmn). m: Unit number, n: Channel number (mn = 00, 01))

**(5) Communication at different potential (1.8 V, 2.5 V, 3 V) (CSI mode) (master mode, SCKp... internal clock output)****(1/2)****(T<sub>A</sub> = -40 to +105°C, 2.4 V ≤ EV<sub>DD</sub> = V<sub>DD</sub> ≤ 5.5 V, V<sub>SS</sub> = EV<sub>SS</sub> = 0 V)**

| Parameter             | Symbol            | Conditions   | HS (high-speed main) Mode  |      | Unit |
|-----------------------|-------------------|--|----------------------------|------|------|
|                       |                   |  | MIN.                       | MAX. |      |
| SCKp cycle time       | t <sub>KCY1</sub> | t <sub>KCY1</sub> ≥ 4/f <sub>CLK</sub><br>4.0 V ≤ EV <sub>DD</sub> ≤ 5.5 V, 2.7 V ≤ V <sub>b</sub> ≤ 4.0 V,<br>C <sub>b</sub> = 30 pF, R <sub>b</sub> = 1.4 kΩ | 600                        |      | ns   |
|                       |                   | 2.7 V ≤ EV <sub>DD</sub> < 4.0 V, 2.3 V ≤ V <sub>b</sub> ≤ 2.7 V,<br>C <sub>b</sub> = 30 pF, R <sub>b</sub> = 2.7 kΩ   | 600                        |      | ns   |
|                       |                   | 2.4 V ≤ EV <sub>DD</sub> < 3.3 V, 1.6 V ≤ V <sub>b</sub> ≤ 2.0 V,<br>C <sub>b</sub> = 30 pF, R <sub>b</sub> = 5.5 kΩ   | 2300                       |      | ns   |
| SCKp high-level width | t <sub>KH1</sub>  | 4.0 V ≤ EV <sub>DD</sub> ≤ 5.5 V, 2.7 V ≤ V <sub>b</sub> ≤ 4.0 V,<br>C <sub>b</sub> = 30 pF, R <sub>b</sub> = 1.4 kΩ   | t <sub>KCY1</sub> /2 – 150 |      | ns   |
|                       |                   | 2.7 V ≤ EV <sub>DD</sub> < 4.0 V, 2.3 V ≤ V <sub>b</sub> ≤ 2.7 V,<br>C <sub>b</sub> = 30 pF, R <sub>b</sub> = 2.7 kΩ   | t <sub>KCY1</sub> /2 – 340 |      | ns   |
|                       |                   | 2.4 V ≤ EV <sub>DD</sub> < 3.3 V, 1.6 V ≤ V <sub>b</sub> ≤ 2.0 V,<br>C <sub>b</sub> = 30 pF, R <sub>b</sub> = 5.5 kΩ   | t <sub>KCY1</sub> /2 – 916 |      | ns   |
| SCKp low-level width  | t <sub>KL1</sub>  | 4.0 V ≤ EV <sub>DD</sub> ≤ 5.5 V, 2.7 V ≤ V <sub>b</sub> ≤ 4.0 V,<br>C <sub>b</sub> = 30 pF, R <sub>b</sub> = 1.4 kΩ   | t <sub>KCY1</sub> /2 – 24  |      | ns   |
|                       |                   | 2.7 V ≤ EV <sub>DD</sub> < 4.0 V, 2.3 V ≤ V <sub>b</sub> ≤ 2.7 V,<br>C <sub>b</sub> = 30 pF, R <sub>b</sub> = 2.7 kΩ   | t <sub>KCY1</sub> /2 – 36  |      | ns   |
|                       |                   | 2.4 V ≤ EV <sub>DD</sub> < 3.3 V, 1.6 V ≤ V <sub>b</sub> ≤ 2.0 V,<br>C <sub>b</sub> = 30 pF, R <sub>b</sub> = 5.5 kΩ   | t <sub>KCY1</sub> /2 – 100 |      | ns   |

**Caution** Select the TTL input buffer for the SIp pin and the N-ch open drain output (V<sub>DD</sub> tolerance (32- to 52-pin products)/EV<sub>DD</sub> tolerance (64-pin products)) mode for the SOp pin and SCKp pin by using port input mode register g (PIMg) and port output mode register g (POMg). For V<sub>IH</sub> and V<sub>IL</sub>, see the DC characteristics with TTL input buffer selected.



**(5) Communication at different potential (1.8 V, 2.5 V, 3 V) (CSI mode) (master mode, SCKp... internal clock output)****(2/2)****(T<sub>A</sub> = -40 to +105°C, 2.4 V ≤ EV<sub>DD</sub> = V<sub>DD</sub> ≤ 5.5 V, V<sub>SS</sub> = EV<sub>SS</sub> = 0 V)**

| Parameter  | Symbol            | Conditions   | HS (high-speed main) Mode |      | Unit |
|--|-------------------|--|---------------------------|------|------|
|  |                   |  | MIN.                      | MAX. |      |
| Slp setup time<br>(to SCKp↑) <sup>Note 1</sup>                       | t <sub>SIK1</sub> | 4.0 V ≤ EV <sub>DD</sub> ≤ 5.5 V, 2.7 V ≤ V <sub>b</sub> ≤ 4.0 V,<br>C <sub>b</sub> = 30 pF, R <sub>b</sub> = 1.4 kΩ | 162                       |      | ns   |
|  |                   | 2.7 V ≤ EV <sub>DD</sub> < 4.0 V, 2.3 V ≤ V <sub>b</sub> ≤ 2.7 V,<br>C <sub>b</sub> = 30 pF, R <sub>b</sub> = 2.7 kΩ | 354                       |      | ns   |
|  |                   | 2.4 V ≤ EV <sub>DD</sub> < 3.3 V, 1.6 V ≤ V <sub>b</sub> ≤ 2.0 V,<br>C <sub>b</sub> = 30 pF, R <sub>b</sub> = 5.5 kΩ | 958                       |      | ns   |
| Slp hold time<br>(from SCKp↑) <sup>Note 1</sup>                      | t <sub>SH1</sub>  | 4.0 V ≤ EV <sub>DD</sub> ≤ 5.5 V, 2.7 V ≤ V <sub>b</sub> ≤ 4.0 V,<br>C <sub>b</sub> = 30 pF, R <sub>b</sub> = 1.4 kΩ | 38                        |      | ns   |
|  |                   | 2.7 V ≤ EV <sub>DD</sub> < 4.0 V, 2.3 V ≤ V <sub>b</sub> ≤ 2.7 V,<br>C <sub>b</sub> = 30 pF, R <sub>b</sub> = 2.7 kΩ | 38                        |      | ns   |
|  |                   | 2.4 V ≤ EV <sub>DD</sub> < 3.3 V, 1.6 V ≤ V <sub>b</sub> ≤ 2.0 V,<br>C <sub>b</sub> = 30 pF, R <sub>b</sub> = 5.5 kΩ | 38                        |      | ns   |
| Delay time from SCKp↓ to<br>SO <sub>p</sub> output <sup>Note 1</sup> | t <sub>KSO1</sub> | 4.0 V ≤ EV <sub>DD</sub> ≤ 5.5 V, 2.7 V ≤ V <sub>b</sub> ≤ 4.0 V,<br>C <sub>b</sub> = 30 pF, R <sub>b</sub> = 1.4 kΩ |                           | 200  | ns   |
|  |                   | 2.7 V ≤ EV <sub>DD</sub> < 4.0 V, 2.3 V ≤ V <sub>b</sub> ≤ 2.7 V,<br>C <sub>b</sub> = 30 pF, R <sub>b</sub> = 2.7 kΩ |                           | 390  | ns   |
|  |                   | 2.4 V ≤ EV <sub>DD</sub> < 3.3 V, 1.6 V ≤ V <sub>b</sub> ≤ 2.0 V,<br>C <sub>b</sub> = 30 pF, R <sub>b</sub> = 2.7 kΩ |                           | 966  | ns   |
| Slp setup time<br>(to SCKp↓) <sup>Note</sup>                         | t <sub>SIK1</sub> | 4.0 V ≤ EV <sub>DD</sub> ≤ 5.5 V, 2.7 V ≤ V <sub>b</sub> ≤ 4.0 V,<br>C <sub>b</sub> = 30 pF, R <sub>b</sub> = 1.4 kΩ | 88                        |      | ns   |
|  |                   | 2.7 V ≤ EV <sub>DD</sub> < 4.0 V, 2.3 V ≤ V <sub>b</sub> ≤ 2.7 V,<br>C <sub>b</sub> = 30 pF, R <sub>b</sub> = 2.7 kΩ | 88                        |      | ns   |
|  |                   | 2.4 V ≤ EV <sub>DD</sub> < 3.3 V, 1.6 V ≤ V <sub>b</sub> ≤ 2.0 V,<br>C <sub>b</sub> = 30 pF, R <sub>b</sub> = 5.5 kΩ | 220                       |      | ns   |
| Slp hold time<br>(from SCKp↓) <sup>Note 2</sup>                      | t <sub>SH1</sub>  | 4.0 V ≤ EV <sub>DD</sub> ≤ 5.5 V, 2.7 V ≤ V <sub>b</sub> ≤ 4.0 V,<br>C <sub>b</sub> = 30 pF, R <sub>b</sub> = 1.4 kΩ | 38                        |      | ns   |
|  |                   | 2.7 V ≤ EV <sub>DD</sub> < 4.0 V, 2.3 V ≤ V <sub>b</sub> ≤ 2.7 V,<br>C <sub>b</sub> = 30 pF, R <sub>b</sub> = 2.7 kΩ | 38                        |      | ns   |
|  |                   | 2.4 V ≤ EV <sub>DD</sub> < 3.3 V, 1.6 V ≤ V <sub>b</sub> ≤ 2.0 V,<br>C <sub>b</sub> = 30 pF, R <sub>b</sub> = 5.5 kΩ | 38                        |      | ns   |
| Delay time from SCKp↑ to<br>SO <sub>p</sub> output <sup>Note 2</sup> | t <sub>KSO1</sub> | 4.0 V ≤ EV <sub>DD</sub> ≤ 5.5 V, 2.7 V ≤ V <sub>b</sub> ≤ 4.0 V,<br>C <sub>b</sub> = 30 pF, R <sub>b</sub> = 1.4 kΩ |                           | 50   | ns   |
|  |                   | 2.7 V ≤ EV <sub>DD</sub> < 4.0 V, 2.3 V ≤ V <sub>b</sub> ≤ 2.7 V,<br>C <sub>b</sub> = 30 pF, R <sub>b</sub> = 2.7 kΩ |                           | 50   | ns   |
|  |                   | 2.4 V ≤ EV <sub>DD</sub> < 3.3 V, 1.6 V ≤ V <sub>b</sub> ≤ 2.0 V,<br>C <sub>b</sub> = 30 pF, R <sub>b</sub> = 5.5 kΩ |                           | 50   | ns   |

(Notes, Caution and Remarks are listed on the page after the next page.)

- Notes**
1. When  $\text{DAPmn} = 0$  and  $\text{CKPmn} = 0$ , or  $\text{DAPmn} = 1$  and  $\text{CKPmn} = 1$ .
  2. When  $\text{DAPmn} = 0$  and  $\text{CKPmn} = 1$ , or  $\text{DAPmn} = 1$  and  $\text{CKPmn} = 0$ .

**Caution** Select the TTL input buffer for the  $\text{Slp}$  pin and the N-ch open drain output ( $V_{DD}$  tolerance (32- to 52-pin products)/ $E_{VDD}$  tolerance (64-pin products)) mode for the  $\text{SOp}$  pin and  $\text{SCKp}$  pin by using port input mode register  $g$  (PIMg) and port output mode register  $g$  (POMg). For  $V_{IH}$  and  $V_{IL}$ , see the DC characteristics with TTL input buffer selected.

**CSI mode connection diagram (during communication at different potential)**

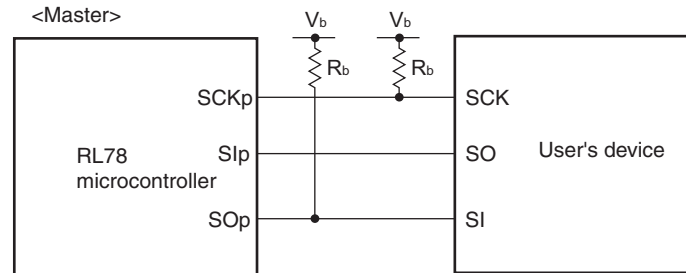

- Remarks**
1.  $R_b[\Omega]$ : Communication line ( $\text{SCKp}$ ,  $\text{SOp}$ ) pull-up resistance,  
 $C_b[\text{F}]$ : Communication line ( $\text{SCKp}$ ,  $\text{SOp}$ ) load capacitance,  $V_b[\text{V}]$ : Communication line voltage
  2.  $p$ : CSI number ( $p = 00, 01$ ),  $m$ : Unit number ( $m = 0$ ),  $n$ : Channel number ( $n = 0, 1$ ),  
 $g$ : PIM and POM number ( $g = 1$ )
  3.  $f_{\text{MCK}}$ : Serial array unit operation clock frequency  
 (Operation clock to be set by the serial clock select register  $m$  ( $\text{SPSm}$ ) and the  $\text{CKSmn}$  bit of serial mode register  $mn$  ( $\text{SMRmn}$ ).  $m$ : Unit number,  $n$ : Channel number ( $mn = 00$ ))

**CSI mode serial transfer timing (master mode) (during communication at different potential)**  
**(When DAPmn = 0 and CKPmn = 0, or DAPmn = 1 and CKPmn = 1.)**

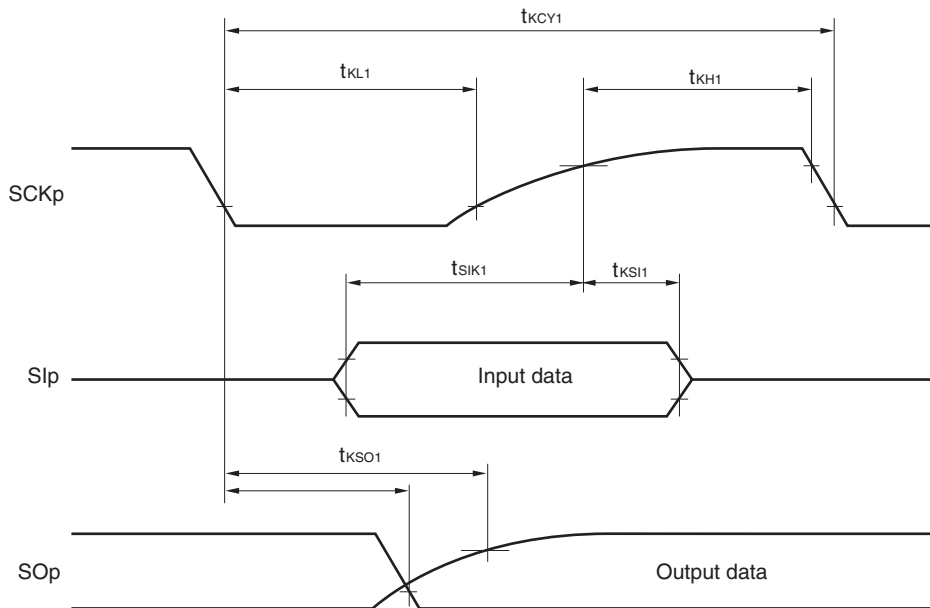

**CSI mode serial transfer timing (master mode) (during communication at different potential)**  
**(When DAPmn = 0 and CKPmn = 1, or DAPmn = 1 and CKPmn = 0.)**

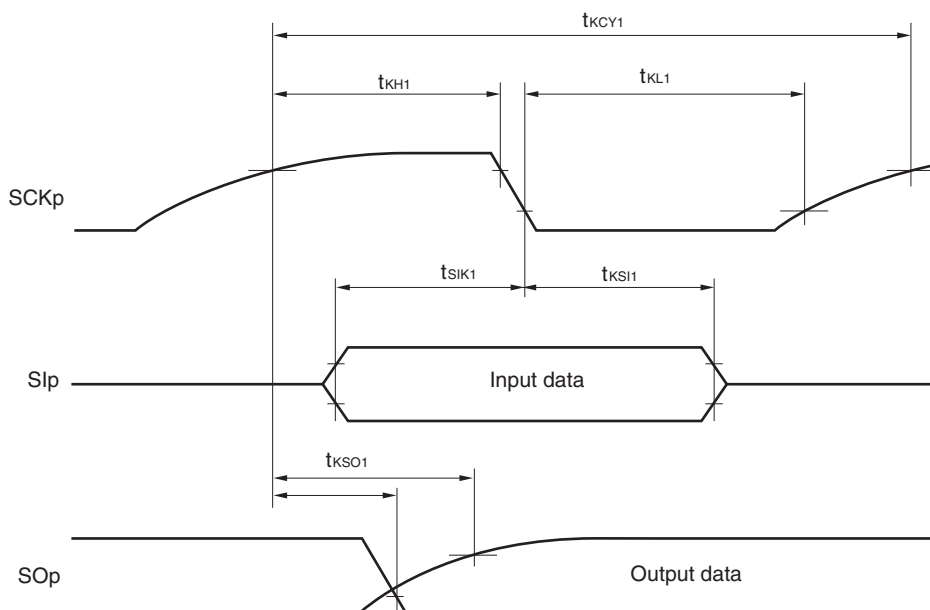

**Remark** p: CSI number (p = 00, 01), m: Unit number (m = 0), n: Channel number (n = 0, 1),  
g: PIM and POM number (g = 1)

**(6) Communication at different potential (1.8 V, 2.5 V, 3 V) (CSI mode) (slave mode, SCKp... external clock input)**  
**(T<sub>A</sub> = -40 to +105°C, 2.4 V ≤ EV<sub>DD</sub> = V<sub>DD</sub> ≤ 5.5 V, V<sub>SS</sub> = EV<sub>SS</sub> = 0 V)**

| Parameter  | Symbol                                 | Conditions   | HS (high-speed main) Mode          |                           | Unit |  |
|--|--|--|------------------------------------|---------------------------|------|--|
|  |  |  | MIN.                               | MAX.                      |      |  |
| SCKp cycle time <sup>Note 1</sup>                        | t <sub>KCY2</sub>                      | 4.0 V ≤ EV <sub>DD</sub> ≤ 5.5 V,<br>2.7 V ≤ V <sub>b</sub> ≤ 4.0 V  | 20 MHz < f <sub>MCK</sub> ≤ 24 MHz | 24/f <sub>MCK</sub>       | ns   |  |
|  |  |  | 8 MHz < f <sub>MCK</sub> ≤ 20 MHz  | 20/f <sub>MCK</sub>       | ns   |  |
|  |  |  | 4 MHz < f <sub>MCK</sub> ≤ 8 MHz   | 16/f <sub>MCK</sub>       | ns   |  |
|  |  |  | f <sub>MCK</sub> ≤ 4 MHz           | 12/f <sub>MCK</sub>       | ns   |  |
|  |  | 2.7 V ≤ EV <sub>DD</sub> < 4.0 V,<br>2.3 V ≤ V <sub>b</sub> ≤ 2.7 V  | 20 MHz < f <sub>MCK</sub> ≤ 24 MHz | 32/f <sub>MCK</sub>       | ns   |  |
|  |  |  | 16 MHz < f <sub>MCK</sub> ≤ 20 MHz | 28/f <sub>MCK</sub>       | ns   |  |
|  |  |  | 8 MHz < f <sub>MCK</sub> ≤ 16 MHz  | 24/f <sub>MCK</sub>       | ns   |  |
|  |  |  | 4 MHz < f <sub>MCK</sub> ≤ 8 MHz   | 16/f <sub>MCK</sub>       | ns   |  |
|  |  | 2.4 V ≤ EV <sub>DD</sub> < 3.3 V,<br>1.6 V ≤ V <sub>b</sub> ≤ 2.0 V  | 20 MHz < f <sub>MCK</sub> ≤ 24 MHz | 72/f <sub>MCK</sub>       | ns   |  |
|  |  |  | 16 MHz < f <sub>MCK</sub> ≤ 20 MHz | 64/f <sub>MCK</sub>       | ns   |  |
|  |  |  | 8 MHz < f <sub>MCK</sub> ≤ 16 MHz  | 52/f <sub>MCK</sub>       | ns   |  |
|  |  |  | 4 MHz < f <sub>MCK</sub> ≤ 8 MHz   | 32/f <sub>MCK</sub>       | ns   |  |
|  |  |  | f <sub>MCK</sub> ≤ 4 MHz           | 20/f <sub>MCK</sub>       | ns   |  |
|  |  |  |                                    |                           |      |  |
|  |  |  |                                    |                           |      |  |
|  |  |  |                                    |                           |      |  |
| SCKp high-/low-level width                               | t <sub>KH2</sub> ,<br>t <sub>KL2</sub> | 4.0 V ≤ EV <sub>DD</sub> ≤ 5.5 V,<br>2.7 V ≤ V <sub>b</sub> ≤ 4.0 V  | t <sub>KCY2</sub> /2 – 24          | ns                        |      |  |
|  |  | 2.7 V ≤ EV <sub>DD</sub> < 4.0 V,<br>2.3 V ≤ V <sub>b</sub> ≤ 2.7 V  | t <sub>KCY2</sub> /2 – 36          | ns                        |      |  |
|  |  | 2.4 V ≤ EV <sub>DD</sub> < 3.3 V,<br>1.6 V ≤ V <sub>b</sub> ≤ 2.0 V  | t <sub>KCY2</sub> /2 – 100         | ns                        |      |  |
| Slp setup time<br>(to SCKp↑) <sup>Note 2</sup>           | t <sub>SIK2</sub>                      | 4.0 V ≤ EV <sub>DD</sub> ≤ 5.5 V,<br>2.7 V ≤ V <sub>b</sub> ≤ 4.0 V  | 1/f <sub>MCK</sub> + 40            | ns                        |      |  |
|  |  | 2.7 V ≤ EV <sub>DD</sub> < 4.0 V,<br>2.3 V ≤ V <sub>b</sub> ≤ 2.7 V  | 1/f <sub>MCK</sub> + 40            | ns                        |      |  |
|  |  | 2.4 V ≤ EV <sub>DD</sub> < 3.3 V,<br>1.6 V ≤ V <sub>b</sub> ≤ 2.0 V  | 1/f <sub>MCK</sub> + 60            | ns                        |      |  |
| Slp hold time<br>(from SCKp↑) <sup>Note 3</sup>          | t <sub>KSI2</sub>                      | 4.0 V ≤ EV <sub>DD</sub> ≤ 5.5 V,<br>2.7 V ≤ V <sub>b</sub> ≤ 4.0 V  | 1/f <sub>MCK</sub> + 62            | ns                        |      |  |
|  |  | 2.7 V ≤ EV <sub>DD</sub> < 4.0 V,<br>2.3 V ≤ V <sub>b</sub> ≤ 2.7 V  | 1/f <sub>MCK</sub> + 62            | ns                        |      |  |
|  |  | 2.4 V ≤ EV <sub>DD</sub> < 3.3 V,<br>1.6 V ≤ V <sub>b</sub> ≤ 2.0 V  | 1/f <sub>MCK</sub> + 62            | ns                        |      |  |
| Delay time from SCKp↓ to<br>SOp output <sup>Note 4</sup> | t <sub>KSO2</sub>                      | 4.0 V ≤ EV <sub>DD</sub> ≤ 5.5 V, 2.7 V ≤ V <sub>b</sub> ≤ 4.0 V,<br>C <sub>b</sub> = 30 pF, R <sub>b</sub> = 1.4 kΩ |                                    | 2/f <sub>MCK</sub> + 240  | ns   |  |
|  |  | 2.7 V ≤ EV <sub>DD</sub> < 4.0 V, 2.3 V ≤ V <sub>b</sub> ≤ 2.7 V,<br>C <sub>b</sub> = 30 pF, R <sub>b</sub> = 2.7 kΩ |                                    | 2/f <sub>MCK</sub> + 428  | ns   |  |
|  |  | 2.4 V ≤ EV <sub>DD</sub> < 3.3 V, 1.6 V ≤ V <sub>b</sub> ≤ 2.0 V<br>C <sub>b</sub> = 30 pF, R <sub>b</sub> = 5.5 kΩ  |                                    | 2/f <sub>MCK</sub> + 1146 | ns   |  |

(Notes, Caution and Remarks are listed on the page after the next page.)

- Notes**
1. Transfer rate in the SNOOZE mode : MAX. 1 Mbps
  2. When  $\text{DAPmn} = 0$  and  $\text{CKPmn} = 0$ , or  $\text{DAPmn} = 1$  and  $\text{CKPmn} = 1$ . The  $\text{Slp}$  setup time becomes “to  $\text{SCKp}\downarrow$ ” when  $\text{DAPmn} = 0$  and  $\text{CKPmn} = 1$ , or  $\text{DAPmn} = 1$  and  $\text{CKPmn} = 0$ .
  3. When  $\text{DAPmn} = 0$  and  $\text{CKPmn} = 0$ , or  $\text{DAPmn} = 1$  and  $\text{CKPmn} = 1$ . The  $\text{Slp}$  hold time becomes “from  $\text{SCKp}\downarrow$ ” when  $\text{DAPmn} = 0$  and  $\text{CKPmn} = 1$ , or  $\text{DAPmn} = 1$  and  $\text{CKPmn} = 0$ .
  4. When  $\text{DAPmn} = 0$  and  $\text{CKPmn} = 0$ , or  $\text{DAPmn} = 1$  and  $\text{CKPmn} = 1$ . The delay time to  $\text{SOp}$  output becomes “from  $\text{SCKp}\uparrow$ ” when  $\text{DAPmn} = 0$  and  $\text{CKPmn} = 1$ , or  $\text{DAPmn} = 1$  and  $\text{CKPmn} = 0$ .

**Caution** Select the TTL input buffer for the  $\text{Slp}$  pin and  $\text{SCKp}$  pin and the N-ch open drain output ( $V_{DD}$  tolerance (32- to 52-pin products)/ $\text{EV}_{DD}$  tolerance (64-pin products)) mode for the  $\text{SOp}$  pin by using port input mode register g (PIMg) and port output mode register g (POMg). For  $V_{IH}$  and  $V_{IL}$ , see the DC characteristics with TTL input buffer selected.

**CSI mode connection diagram (during communication at different potential)**

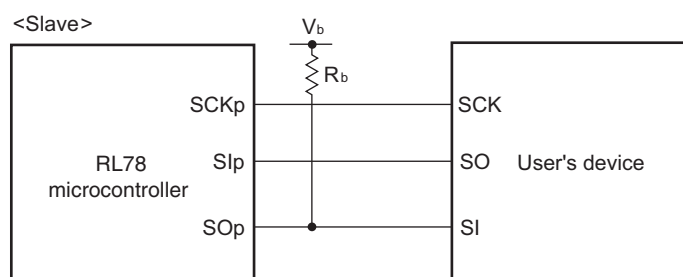

- Remarks**
1.  $R_b[\Omega]$ : Communication line ( $\text{SOp}$ ) pull-up resistance,  
 $C_b[\text{F}]$ : Communication line ( $\text{SOp}$ ) load capacitance,  $V_b[\text{V}]$ : Communication line voltage
  2. p: CSI number ( $p = 00, 01$ ), m: Unit number ( $m = 0$ ), n: Channel number ( $n = 0, 1$ ),  
g: PIM and POM number ( $g = 1$ )
  3.  $f_{\text{MCK}}$ : Serial array unit operation clock frequency  
(Operation clock to be set by the serial clock select register m (SPSm) and the CKSmn bit of serial mode register mn (SMRmn). m: Unit number, n: Channel number ( $mn = 00, 01$ ))

**CSI mode serial transfer timing (slave mode) (during communication at different potential)**  
**(When DAPmn = 0 and CKPmn = 0, or DAPmn = 1 and CKPmn = 1.)**

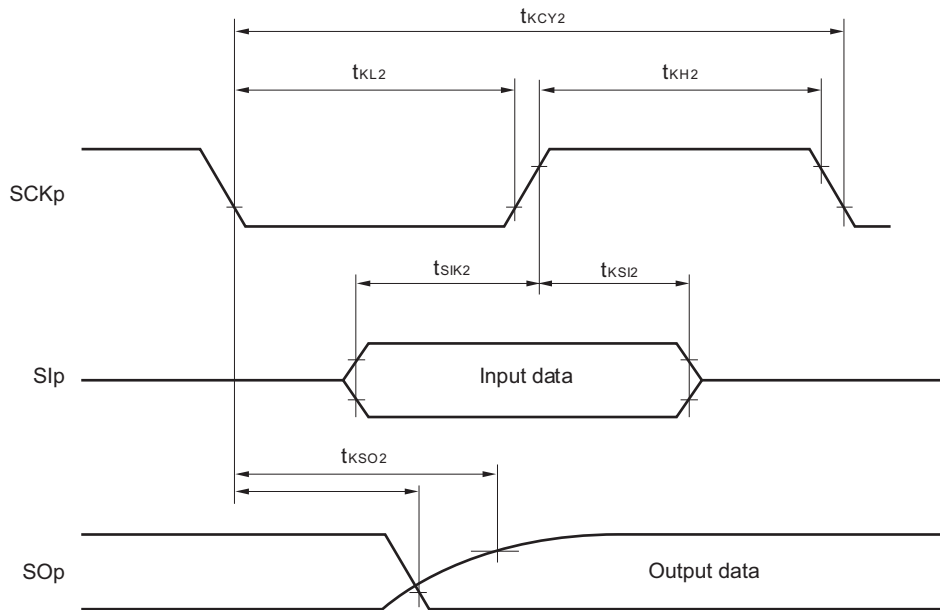

**CSI mode serial transfer timing (slave mode) (during communication at different potential)**  
**(When DAPmn = 0 and CKPmn = 1, or DAPmn = 1 and CKPmn = 0.)**

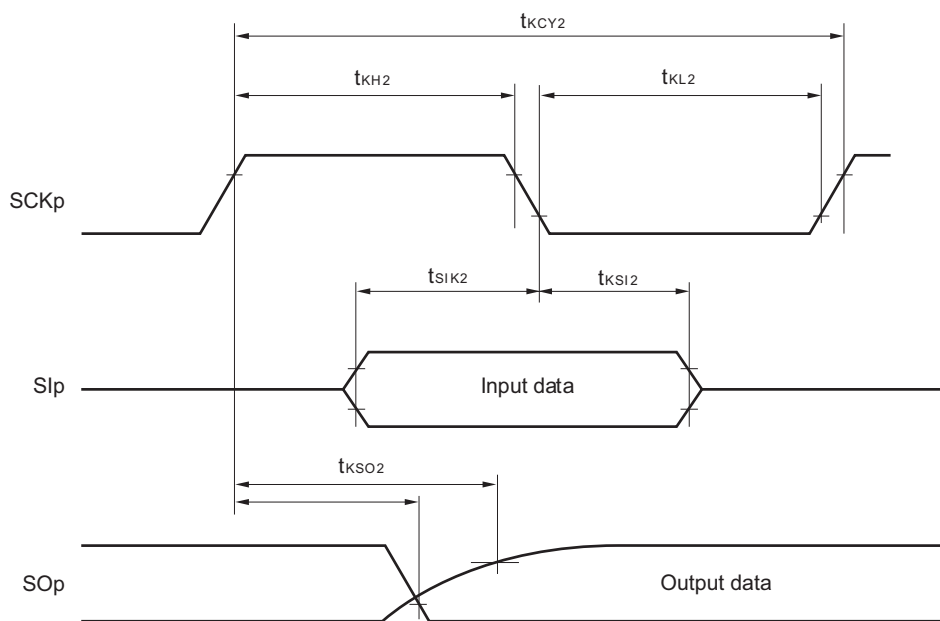

**Remark** p: CSI number (p = 00, 01), m: Unit number (m = 0),  
 n: Channel number (n = 0, 1), g: PIM and POM number (g = 1)

## 3.5.2 Serial interface IICA

(1) I<sup>2</sup>C standard mode(T<sub>A</sub> = -40 to +105°C, 2.4 V ≤ E<sub>VDD</sub> = V<sub>DD</sub> ≤ 5.5 V, V<sub>SS</sub> = E<sub>VSS</sub> = 0 V)

| Parameter                                       | Symbol              | Conditions                       | HS (high-speed main) Mode        |      | Unit |     |
|---|---------------------|----------------------------------|----------------------------------|------|------|-----|
|   |                     |                                  | MIN.                             | MAX. |      |     |
| SCLA0 clock frequency                           | f <sub>SCL</sub>    | Standard mode:                   | 2.7 V ≤ E <sub>VDD</sub> ≤ 5.5 V | 0    | 100  | kHz |
|   |                     | f <sub>CLK</sub> ≥ 1 MHz         | 2.4 V ≤ E <sub>VDD</sub> ≤ 5.5 V | 0    | 100  | kHz |
| Setup time of restart condition                 | t <sub>SU:STA</sub> | 2.7 V ≤ E <sub>VDD</sub> ≤ 5.5 V | 4.7                              |      | μs   |     |
|   |                     | 2.4 V ≤ E <sub>VDD</sub> ≤ 5.5 V | 4.7                              |      | μs   |     |
| Hold time <sup>Note 1</sup>                     | t <sub>HD:STA</sub> | 2.7 V ≤ E <sub>VDD</sub> ≤ 5.5 V | 4.0                              |      | μs   |     |
|   |                     | 2.4 V ≤ E <sub>VDD</sub> ≤ 5.5 V | 4.0                              |      | μs   |     |
| Hold time when SCLA0 = "L"                      | t <sub>LOW</sub>    | 2.7 V ≤ E <sub>VDD</sub> ≤ 5.5 V | 4.7                              |      | μs   |     |
|   |                     | 2.4 V ≤ E <sub>VDD</sub> ≤ 5.5 V | 4.7                              |      | μs   |     |
| Hold time when SCLA0 = "H"                      | t <sub>HIGH</sub>   | 2.7 V ≤ E <sub>VDD</sub> ≤ 5.5 V | 4.0                              |      | μs   |     |
|   |                     | 2.4 V ≤ E <sub>VDD</sub> ≤ 5.5 V | 4.0                              |      | μs   |     |
| Data setup time (reception)                     | t <sub>SU:DAT</sub> | 2.7 V ≤ E <sub>VDD</sub> ≤ 5.5 V | 250                              |      | ns   |     |
|   |                     | 2.4 V ≤ E <sub>VDD</sub> ≤ 5.5 V | 250                              |      | ns   |     |
| Data hold time (transmission) <sup>Note 2</sup> | t <sub>HD:DAT</sub> | 2.7 V ≤ E <sub>VDD</sub> ≤ 5.5 V | 0                                | 3.45 | μs   |     |
|   |                     | 2.4 V ≤ E <sub>VDD</sub> ≤ 5.5 V | 0                                | 3.45 | μs   |     |
| Setup time of stop condition                    | t <sub>SU:STO</sub> | 2.7 V ≤ E <sub>VDD</sub> ≤ 5.5 V | 4.0                              |      | μs   |     |
|   |                     | 2.4 V ≤ E <sub>VDD</sub> ≤ 5.5 V | 4.0                              |      | μs   |     |
| Bus-free time                                   | t <sub>BUF</sub>    | 2.7 V ≤ E <sub>VDD</sub> ≤ 5.5 V | 4.7                              |      | μs   |     |
|   |                     | 2.4 V ≤ E <sub>VDD</sub> ≤ 5.5 V | 4.7                              |      | μs   |     |

**Notes** 1. The first clock pulse is generated after this period when the start/restart condition is detected.

2. The maximum value (MAX.) of t<sub>HD:DAT</sub> is during normal transfer and a wait state is inserted in the ACK (acknowledge) timing.

**Remark** The maximum value of C<sub>b</sub> (communication line capacitance) and the value of R<sub>b</sub> (communication line pull-up resistor) at that time in each mode are as follows.

Standard mode: C<sub>b</sub> = 400 pF, R<sub>b</sub> = 2.7 kΩ

**(2) I<sup>2</sup>C fast mode****(T<sub>A</sub> = -40 to +105°C, 2.4 V ≤ EV<sub>DD</sub> = V<sub>DD</sub> ≤ 5.5 V, V<sub>SS</sub> = EV<sub>SS</sub> = 0 V)**

| Parameter                                       | Symbol              | Conditions                               | HS (high-speed main) Mode        |      | Unit |     |
|---|---------------------|--|----------------------------------|------|------|-----|
|   |                     |  | MIN.                             | MAX. |      |     |
| SCLA0 clock frequency                           | f <sub>SCL</sub>    | Fast mode:<br>f <sub>CLK</sub> ≥ 3.5 MHz | 2.7 V ≤ EV <sub>DD</sub> ≤ 5.5 V | 0    | 400  | kHz |
|   |                     |  | 2.4 V ≤ EV <sub>DD</sub> ≤ 5.5 V | 0    | 400  |     |
| Setup time of restart condition                 | t <sub>SU:STA</sub> | 2.7 V ≤ EV <sub>DD</sub> ≤ 5.5 V         |                                  | 0.6  |      | μs  |
|   |                     | 2.4 V ≤ EV <sub>DD</sub> ≤ 5.5 V         |                                  | 0.6  |      |     |
| Hold time <sup>Note 1</sup>                     | t <sub>HD:STA</sub> | 2.7 V ≤ EV <sub>DD</sub> ≤ 5.5 V         |                                  | 0.6  |      | μs  |
|   |                     | 2.4 V ≤ EV <sub>DD</sub> ≤ 5.5 V         |                                  | 0.6  |      |     |
| Hold time when SCLA0 = "L"                      | t <sub>LOW</sub>    | 2.7 V ≤ EV <sub>DD</sub> ≤ 5.5 V         |                                  | 1.3  |      | μs  |
|   |                     | 2.4 V ≤ EV <sub>DD</sub> ≤ 5.5 V         |                                  | 1.3  |      |     |
| Hold time when SCLA0 = "H"                      | t <sub>HIGH</sub>   | 2.7 V ≤ EV <sub>DD</sub> ≤ 5.5 V         |                                  | 0.6  |      | μs  |
|   |                     | 2.4 V ≤ EV <sub>DD</sub> ≤ 5.5 V         |                                  | 0.6  |      |     |
| Data setup time (reception)                     | t <sub>SU:DAT</sub> | 2.7 V ≤ EV <sub>DD</sub> ≤ 5.5 V         |                                  | 100  |      | ns  |
|   |                     | 2.4 V ≤ EV <sub>DD</sub> ≤ 5.5 V         |                                  | 100  |      |     |
| Data hold time (transmission) <sup>Note 2</sup> | t <sub>HD:DAT</sub> | 2.7 V ≤ EV <sub>DD</sub> ≤ 5.5 V         |                                  | 0    | 0.9  | μs  |
|   |                     | 2.4 V ≤ EV <sub>DD</sub> ≤ 5.5 V         |                                  | 0    | 0.9  |     |
| Setup time of stop condition                    | t <sub>SU:STO</sub> | 2.7 V ≤ EV <sub>DD</sub> ≤ 5.5 V         |                                  | 0.6  |      | μs  |
|   |                     | 2.4 V ≤ EV <sub>DD</sub> ≤ 5.5 V         |                                  | 0.6  |      |     |
| Bus-free time                                   | t <sub>BUF</sub>    | 2.7 V ≤ EV <sub>DD</sub> ≤ 5.5 V         |                                  | 1.3  |      | μs  |
|   |                     | 2.4 V ≤ EV <sub>DD</sub> ≤ 5.5 V         |                                  | 1.3  |      |     |

- Notes**
1. The first clock pulse is generated after this period when the start/restart condition is detected.
  2. The maximum value (MAX.) of t<sub>HD:DAT</sub> is during normal transfer and a wait state is inserted in the ACK (acknowledge) timing.

**Remark** The maximum value of C<sub>b</sub> (communication line capacitance) and the value of R<sub>b</sub> (communication line pull-up resistor) at that time in each mode are as follows.

Fast mode: C<sub>b</sub> = 320 pF, R<sub>b</sub> = 1.1 kΩ



### 3.6 Analog Characteristics

#### 3.6.1 A/D converter characteristics

Classification of A/D converter characteristics

| Input channel  | Reference Voltage  |  |  |
|--|--|--|--|
|  | Reference voltage (+) = AV <sub>REFP</sub><br>Reference voltage (-) = AV <sub>REFM</sub> | Reference voltage (+) = V <sub>DD</sub><br>Reference voltage (-) = V <sub>SS</sub> | Reference voltage (+) = V <sub>BGR</sub><br>Reference voltage (-) = AV <sub>REFM</sub> |
| ANI0, ANI1   | –  | Refer to <b>3.6.1 (3)</b> .  | Refer to <b>3.6.1 (4)</b> .  |
| ANI16 to ANI23   | Refer to <b>3.6.1 (2)</b> .  |  |  |
| Internal reference voltage<br>Temperature sensor output<br>voltage | Refer to <b>3.6.1 (1)</b> .  |  | –  |

**(1) When reference voltage (+) = AV<sub>REFP</sub>/ANI0 (ADREFP1 = 0, ADREFP0 = 1), reference voltage (-) = AV<sub>REFM</sub>/ANI1 (ADREFM = 1), target pin : internal reference voltage, and temperature sensor output voltage**

**(T<sub>A</sub> = -40 to +105°C, 2.4 V ≤ EV<sub>DD</sub> = V<sub>DD</sub> ≤ 5.5 V, 2.4 V ≤ AV<sub>REFP</sub> ≤ V<sub>DD</sub> ≤ 5.5 V, V<sub>SS</sub> = EV<sub>SS</sub> = 0 V, Reference voltage (+) = AV<sub>REFP</sub>, Reference voltage (-) = AV<sub>REFM</sub> = 0 V)**

| Parameter   | Symbol            | Conditions  | MIN.                                  | TYP.   | MAX.  | Unit |
|---|-------------------|---|---------------------------------------|--------|-------|------|
| Resolution  | RES               |   | 8                                     |        | 10    | bit  |
| Overall error <sup>Note 1</sup>                   | AINL              | 10-bit resolution<br>AV <sub>REFP</sub> = V <sub>DD</sub> <sup>Note 3</sup>   | 2.4 V ≤ AV <sub>REFP</sub> ≤ 5.5 V    | 1.2    | ±3.5  | LSB  |
| Conversion time                                   | t <sub>CONV</sub> | 10-bit resolution<br>Target pin: Internal reference<br>voltage, and temperature<br>sensor output voltage (HS<br>(high-speed main) mode) | 3.6 V ≤ V <sub>DD</sub> ≤ 5.5 V       | 2.375  | 39    | μs   |
|   |                   |   | 2.7 V ≤ V <sub>DD</sub> ≤ 5.5 V       | 3.5625 | 39    | μs   |
|   |                   |   | 2.4 V ≤ V <sub>DD</sub> ≤ 5.5 V       | 17     | 39    | μs   |
| Zero-scale error <sup>Notes 1, 2</sup>            | E <sub>ZS</sub>   | 10-bit resolution<br>AV <sub>REFP</sub> = V <sub>DD</sub> <sup>Note 3</sup>   | 1.8 V ≤ AV <sub>REFP</sub> ≤ 5.5 V    |        | ±0.25 | %FSR |
| Full-scale error <sup>Notes 1, 2</sup>            | E <sub>FS</sub>   | 10-bit resolution<br>AV <sub>REFP</sub> = V <sub>DD</sub> <sup>Note 3</sup>   | 1.8 V ≤ AV <sub>REFP</sub> ≤ 5.5 V    |        | ±0.25 | %FSR |
| Integral linearity error <sup>Note 1</sup>        | ILE               | 10-bit resolution<br>AV <sub>REFP</sub> = V <sub>DD</sub> <sup>Note 3</sup>   | 1.8 V ≤ AV <sub>REFP</sub> ≤ 5.5 V    |        | ±2.5  | LSB  |
| Differential linearity error<br><sup>Note 1</sup> | DLE               | 10-bit resolution<br>AV <sub>REFP</sub> = V <sub>DD</sub> <sup>Note 3</sup>   | 1.8 V ≤ AV <sub>REFP</sub> ≤ 5.5 V    |        | ±1.5  | LSB  |
| Analog input voltage                              | V <sub>AIN</sub>  | Internal reference voltage<br>(2.4 V ≤ V <sub>DD</sub> ≤ 5.5 V, HS (high-speed main) mode)  | V <sub>BGR</sub> <sup>Note 4</sup>    |        |       | V    |
|   |                   | Temperature sensor output voltage<br>(2.4 V ≤ V <sub>DD</sub> ≤ 5.5 V, HS (high-speed main) mode)                                       | V <sub>TMPS25</sub> <sup>Note 4</sup> |        |       | V    |

**Notes** 1. Excludes quantization error (±1/2 LSB).

2. This value is indicated as a ratio (%FSR) to the full-scale value.

3. When AV<sub>REFP</sub> < V<sub>DD</sub>, the MAX. values are as follows.

Overall error: Add ±1.0 LSB to the MAX. value when AV<sub>REFP</sub> = V<sub>DD</sub>.

Zero-scale error/Full-scale error: Add ±0.05%FSR to the MAX. value when AV<sub>REFP</sub> = V<sub>DD</sub>.

Integral linearity error/ Differential linearity error: Add ±0.5 LSB to the MAX. value when AV<sub>REFP</sub> = V<sub>DD</sub>.

4. Refer to **3.6.2 Temperature sensor/internal reference voltage characteristics**.

(2) When reference voltage (+) = AV<sub>REFP</sub>/ANI0 (ADREFP1 = 0, ADREFP0 = 1), reference voltage (-) = AV<sub>REFM</sub>/ANI1 (ADREFM = 1), target pin : ANI16 to ANI23

(T<sub>A</sub> = -40 to +105°C, 2.4 V ≤ EV<sub>DD</sub> = V<sub>DD</sub> ≤ 5.5 V, 2.4 V ≤ AV<sub>REFP</sub> ≤ V<sub>DD</sub> ≤ 5.5 V, V<sub>SS</sub> = EV<sub>SS</sub> = 0 V, Reference voltage (+) = AV<sub>REFP</sub>, Reference voltage (-) = AV<sub>REFM</sub> = 0 V)

| Parameter   | Symbol            | Conditions   | MIN.                               | TYP.   | MAX.                                       | Unit  |      |
|---|-------------------|--|------------------------------------|--------|--|-------|------|
| Resolution  | RES               |  | 8                                  |        | 10   | bit   |      |
| Overall error <sup>Note 1</sup>                   | AINL              | 10-bit resolution<br>AV <sub>REFP</sub> = EV <sub>DD</sub> = V <sub>DD</sub> <sup>Note 3</sup> | 2.4 V ≤ AV <sub>REFP</sub> ≤ 5.5 V |        | 1.2  | ±5.0  | LSB  |
| Conversion time                                   | t <sub>CONV</sub> | 10-bit resolution<br>AV <sub>REFP</sub> = EV <sub>DD</sub> = V <sub>DD</sub> <sup>Note 3</sup> | 3.6 V ≤ V <sub>DD</sub> ≤ 5.5 V    | 2.125  |  | 39    | μs   |
|   |                   |  | 2.7 V ≤ V <sub>DD</sub> ≤ 5.5 V    | 3.1875 |  | 39    | μs   |
|   |                   |  | 2.4 V ≤ V <sub>DD</sub> ≤ 5.5 V    | 17     |  | 39    | μs   |
| Zero-scale error <sup>Notes 1, 2</sup>            | E <sub>ZS</sub>   | 10-bit resolution<br>AV <sub>REFP</sub> = EV <sub>DD</sub> = V <sub>DD</sub> <sup>Note 3</sup> | 2.4 V ≤ AV <sub>REFP</sub> ≤ 5.5 V |        |  | ±0.35 | %FSR |
| Full-scale error <sup>Notes 1, 2</sup>            | E <sub>FS</sub>   | 10-bit resolution<br>AV <sub>REFP</sub> = EV <sub>DD</sub> = V <sub>DD</sub> <sup>Note 3</sup> | 2.4 V ≤ AV <sub>REFP</sub> ≤ 5.5 V |        |  | ±0.35 | %FSR |
| Integral linearity error <sup>Note 1</sup>        | ILE               | 10-bit resolution<br>AV <sub>REFP</sub> = EV <sub>DD</sub> = V <sub>DD</sub> <sup>Note 3</sup> | 2.4 V ≤ AV <sub>REFP</sub> ≤ 5.5 V |        |  | ±3.5  | LSB  |
| Differential linearity error<br><sup>Note 1</sup> | DLE               | 10-bit resolution<br>AV <sub>REFP</sub> = EV <sub>DD</sub> = V <sub>DD</sub> <sup>Note 3</sup> | 2.4 V ≤ AV <sub>REFP</sub> ≤ 5.5 V |        |  | ±2.0  | LSB  |
| Analog input voltage                              | V <sub>AIN</sub>  | ANI16 to ANI23   | 0                                  |        | AV <sub>REFP</sub><br>and EV <sub>DD</sub> | V     |      |

**Notes** 1. Excludes quantization error (±1/2 LSB).

2. This value is indicated as a ratio (%FSR) to the full-scale value.

3. When AV<sub>REFP</sub> < EV<sub>DD</sub> = V<sub>DD</sub>, the MAX. values are as follows.

Overall error: Add ±4.0 LSB to the MAX. value when AV<sub>REFP</sub> = V<sub>DD</sub>.

Zero-scale error/Full-scale error: Add ±0.20%FSR to the MAX. value when AV<sub>REFP</sub> = V<sub>DD</sub>.

Integral linearity error/ Differential linearity error: Add ±2.0 LSB to the MAX. value when AV<sub>REFP</sub> = V<sub>DD</sub>.

(3) When reference voltage (+) = V<sub>DD</sub> (ADREFP1 = 0, ADREFP0 = 0), reference voltage (-) = V<sub>SS</sub> (ADREFM = 0), target pin : ANI0, ANI1, ANI16 to ANI23, internal reference voltage, and temperature sensor output voltage

(T<sub>A</sub> = -40 to +105°C, 2.4 V ≤ EV<sub>DD</sub> = V<sub>DD</sub> ≤ 5.5 V, V<sub>SS</sub> = EV<sub>SS</sub> = 0 V, Reference voltage (+) = V<sub>DD</sub>, Reference voltage (-) = V<sub>SS</sub>)

| Parameter   | Symbol            | Conditions  |                                 | MIN.                                  | TYP. | MAX.             | Unit |   |
|---|-------------------|---|---------------------------------|---------------------------------------|------|------------------|------|---|
| Resolution  | RES               |   |                                 | 8                                     |      | 10               | bit  |   |
| Overall error <sup>Note 1</sup>                   | AINL              | 10-bit resolution   | 2.4 V ≤ V <sub>DD</sub> ≤ 5.5 V |                                       | 1.2  | ±7.0             | LSB  |   |
| Conversion time                                   | t <sub>CONV</sub> | 10-bit resolution   | 3.6 V ≤ V <sub>DD</sub> ≤ 5.5 V | 2.125                                 |      | 39               | μs   |   |
|   |                   |   | 2.7 V ≤ V <sub>DD</sub> ≤ 5.5 V | 3.1875                                |      | 39               | μs   |   |
|   |                   |   | 2.4 V ≤ V <sub>DD</sub> ≤ 5.5 V | 17                                    |      | 39               | μs   |   |
|   |                   | 10-bit resolution<br>Target pin: Internal reference<br>voltage, and temperature<br>sensor output voltage (HS<br>(high-speed main) mode) | 3.6 V ≤ V <sub>DD</sub> ≤ 5.5 V | 2.375                                 |      | 39               | μs   |   |
|   |                   |   | 2.7 V ≤ V <sub>DD</sub> ≤ 5.5 V | 3.5625                                |      | 39               | μs   |   |
|   |                   |   | 2.4 V ≤ V <sub>DD</sub> ≤ 5.5 V | 17                                    |      | 39               | μs   |   |
| Zero-scale error <sup>Notes 1, 2</sup>            | E <sub>ZS</sub>   | 10-bit resolution   | 2.4 V ≤ V <sub>DD</sub> ≤ 5.5 V |                                       |      | ±0.60            | %FSR |   |
| Full-scale error <sup>Notes 1, 2</sup>            | E <sub>FS</sub>   | 10-bit resolution   | 2.4 V ≤ V <sub>DD</sub> ≤ 5.5 V |                                       |      | ±0.60            | %FSR |   |
| Integral linearity error <sup>Note 1</sup>        | ILE               | 10-bit resolution   | 2.4 V ≤ V <sub>DD</sub> ≤ 5.5 V |                                       |      | ±4.0             | LSB  |   |
| Differential linearity error<br><sup>Note 1</sup> | DLE               | 10-bit resolution   | 2.4 V ≤ V <sub>DD</sub> ≤ 5.5 V |                                       |      | ±2.0             | LSB  |   |
| Analog input voltage                              | V <sub>AIN</sub>  | ANI0, ANI1  |                                 | 0                                     |      | V <sub>DD</sub>  | V    |   |
|   |                   | ANI16 to ANI23  |                                 | 0                                     |      | EV <sub>DD</sub> | V    |   |
|   |                   | Internal reference voltage output<br>(2.4 V ≤ V <sub>DD</sub> ≤ 5.5 V, HS (high-speed main) mode)                                       |                                 | V <sub>BGR</sub> <sup>Note 3</sup>    |      |                  |      | V |
|   |                   | Temperature sensor output voltage<br>(2.4 V ≤ V <sub>DD</sub> ≤ 5.5 V, HS (high-speed main) mode)                                       |                                 | V <sub>TMPS25</sub> <sup>Note 3</sup> |      |                  |      | V |

**Notes** 1. Excludes quantization error (±1/2 LSB).

2. This value is indicated as a ratio (%FSR) to the full-scale value.

3. Refer to **3.6.2 Temperature sensor/internal reference voltage characteristics**.

(4) When reference voltage (+) = Internal reference voltage (ADREFP1 = 1, ADREFP0 = 0), reference voltage (-) = AV<sub>REFM</sub>/ANI1 (ADREFM = 1), target pin : ANI0, ANI16 to ANI23

(T<sub>A</sub> = -40 to +105°C, 2.4 V ≤ EV<sub>DD</sub> = V<sub>DD</sub> ≤ 5.5 V, V<sub>SS</sub> = EV<sub>SS</sub> = 0 V, Reference voltage (+) = V<sub>BGR</sub> <sup>Note 3</sup>, Reference voltage (-) = AV<sub>REFM</sub> <sup>Note 4</sup> = 0 V, HS (high-speed main) mode)

| Parameter                                      | Symbol            | Conditions       |                                 | MIN. | TYP. | MAX.                               | Unit |
|--|-------------------|------------------|---------------------------------|------|------|------------------------------------|------|
| Resolution                                     | RES               |                  |                                 | 8    |      |                                    | bit  |
| Conversion time                                | t <sub>CONV</sub> | 8-bit resolution | 2.4 V ≤ V <sub>DD</sub> ≤ 5.5 V | 17   |      | 39                                 | μs   |
| Zero-scale error <sup>Notes 1, 2</sup>         | E <sub>ZS</sub>   | 8-bit resolution | 2.4 V ≤ V <sub>DD</sub> ≤ 5.5 V |      |      | ±0.60                              | %FSR |
| Integral linearity error <sup>Note 1</sup>     | ILE               | 8-bit resolution | 2.4 V ≤ V <sub>DD</sub> ≤ 5.5 V |      |      | ±2.0                               | LSB  |
| Differential linearity error <sup>Note 1</sup> | DLE               | 8-bit resolution | 2.4 V ≤ V <sub>DD</sub> ≤ 5.5 V |      |      | ±1.0                               | LSB  |
| Analog input voltage                           | V <sub>AIN</sub>  |                  |                                 | 0    |      | V <sub>BGR</sub> <sup>Note 3</sup> | V    |

**Notes** 1. Excludes quantization error (±1/2 LSB).

2. This value is indicated as a ratio (%FSR) to the full-scale value.

3. Refer to **3.6.2 Temperature sensor/internal reference voltage characteristics**.

4. When reference voltage (-) = V<sub>SS</sub>, the MAX. values are as follows.

Zero-scale error: Add ±0.35%FSR to the MAX. value when reference voltage (-) = AV<sub>REFM</sub>.

Integral linearity error: Add ±0.5 LSB to the MAX. value when reference voltage (-) = AV<sub>REFM</sub>.

Differential linearity error: Add ±0.2 LSB to the MAX. value when reference voltage (-) = AV<sub>REFM</sub>.

## 3.6.2 Temperature sensor/internal reference voltage characteristics

(T<sub>A</sub> =  $-40$  to  $+105^\circ\text{C}$ ,  $2.4\text{ V} \leq \text{EV}_{\text{DD}} = \text{V}_{\text{DD}} \leq 5.5\text{ V}$ ,  $\text{V}_{\text{SS}} = \text{EV}_{\text{SS}} = 0\text{ V}$ , HS (high-speed main) mode)

| Parameter                         | Symbol              | Conditions   | MIN. | TYP. | MAX. | Unit                 |
|-----------------------------------|---------------------|--|------|------|------|----------------------|
| Temperature sensor output voltage | V <sub>TMP25</sub>  | Setting ADS register = 80H, T <sub>A</sub> = $+25^\circ\text{C}$ |      | 1.05 |      | V                    |
| Internal reference voltage        | V <sub>BGR</sub>    | Setting ADS register = 81H                                       | 1.38 | 1.45 | 1.5  | V                    |
| Temperature coefficient           | F <sub>VTMP25</sub> | Temperature sensor that depends on the temperature               |      | -3.6 |      | mV/ $^\circ\text{C}$ |
| Operation stabilization wait time | t <sub>AMP</sub>    |  | 5    |      |      | $\mu\text{s}$        |

## 3.6.3 POR circuit characteristics

(T<sub>A</sub> =  $-40$  to  $+105^\circ\text{C}$ ,  $\text{V}_{\text{SS}} = 0\text{ V}$ )

| Parameter           | Symbol           | Conditions             | MIN. | TYP. | MAX. | Unit          |
|---------------------|------------------|------------------------|------|------|------|---------------|
| Detection voltage   | V <sub>POR</sub> | Power supply rise time | 1.45 | 1.51 | 1.57 | V             |
|                     | V <sub>PDR</sub> | Power supply fall time | 1.44 | 1.50 | 1.56 | V             |
| Minimum pulse width | T <sub>PW</sub>  |                        | 300  |      |      | $\mu\text{s}$ |

**Note** Minimum time required for a POR reset when V<sub>DD</sub> exceeds below V<sub>PDR</sub>. This is also the minimum time required for a POR reset from when V<sub>DD</sub> exceeds below 0.7 V to when V<sub>DD</sub> exceeds V<sub>POR</sub> while STOP mode is entered or the main system clock is stopped through setting bit 0 (HIOSTOP) and bit 7 (MSTOP) in the clock operation status control register (CSC).

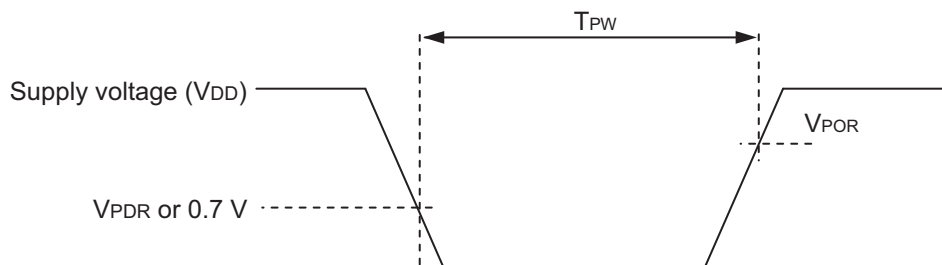

## 3.6.4 LVD circuit characteristics

(T<sub>A</sub> = -40 to +105°C, V<sub>PDR</sub> ≤ EV<sub>DD</sub> = V<sub>DD</sub> ≤ 5.5 V, V<sub>SS</sub> = EV<sub>SS</sub> = 0 V)

| Parameter            |                      | Symbol            | Conditions             | MIN. | TYP. | MAX. | Unit |
|----------------------|----------------------|-------------------|------------------------|------|------|------|------|
| Detection voltage    | Supply voltage level | V <sub>LVD0</sub> | Power supply rise time | 3.90 | 4.06 | 4.22 | V    |
|                      |                      |                   | Power supply fall time | 3.83 | 3.98 | 4.13 | V    |
|                      |                      | V <sub>LVD1</sub> | Power supply rise time | 3.60 | 3.75 | 3.90 | V    |
|                      |                      |                   | Power supply fall time | 3.53 | 3.67 | 3.81 | V    |
|                      |                      | V <sub>LVD2</sub> | Power supply rise time | 3.01 | 3.13 | 3.25 | V    |
|                      |                      |                   | Power supply fall time | 2.94 | 3.06 | 3.18 | V    |
|                      |                      | V <sub>LVD3</sub> | Power supply rise time | 2.90 | 3.02 | 3.14 | V    |
|                      |                      |                   | Power supply fall time | 2.85 | 2.96 | 3.07 | V    |
|                      |                      | V <sub>LVD4</sub> | Power supply rise time | 2.81 | 2.92 | 3.03 | V    |
|                      |                      |                   | Power supply fall time | 2.75 | 2.86 | 2.97 | V    |
|                      |                      | V <sub>LVD5</sub> | Power supply rise time | 2.70 | 2.81 | 2.92 | V    |
|                      |                      |                   | Power supply fall time | 2.64 | 2.75 | 2.86 | V    |
|                      |                      | V <sub>LVD6</sub> | Power supply rise time | 2.61 | 2.71 | 2.81 | V    |
|                      |                      |                   | Power supply fall time | 2.55 | 2.65 | 2.75 | V    |
|                      |                      | V <sub>LVD7</sub> | Power supply rise time | 2.51 | 2.61 | 2.71 | V    |
|                      |                      |                   | Power supply fall time | 2.45 | 2.55 | 2.65 | V    |
| Minimum pulse width  |                      | t <sub>LW</sub>   |                        | 300  |      |      | μs   |
| Detection delay time |                      |                   |                        |      |      | 300  | μs   |

## LVD Detection Voltage of Interrupt &amp; Reset Mode

(T<sub>A</sub> = -40 to +105°C, V<sub>PDR</sub> ≤ EV<sub>DD</sub> = V<sub>DD</sub> ≤ 5.5 V, V<sub>SS</sub> = EV<sub>SS</sub> = 0 V)

| Parameter                | Symbol             | Conditions   | MIN.                | TYP.                         | MAX. | Unit |      |   |
|--------------------------|--------------------|--|---------------------|------------------------------|------|------|------|---|
| Interrupt and reset mode | V <sub>LVDD0</sub> | V <sub>POC2</sub> , V <sub>POC1</sub> , V <sub>POC0</sub> = 0, 1, 1, falling reset voltage |                     | 2.64                         | 2.75 | 2.86 | V    |   |
|                          | V <sub>LVDD1</sub> |  | LVIS1, LVIS0 = 1, 0 | Rising release reset voltage | 2.81 | 2.92 | 3.03 | V |
|                          |                    |  |                     | Falling interrupt voltage    | 2.75 | 2.86 | 2.97 | V |
|                          | V <sub>LVDD2</sub> |  | LVIS1, LVIS0 = 0, 1 | Rising release reset voltage | 2.90 | 3.02 | 3.14 | V |
|                          |                    |  |                     | Falling interrupt voltage    | 2.85 | 2.96 | 3.07 | V |
|                          | V <sub>LVDD3</sub> |  | LVIS1, LVIS0 = 0, 0 | Rising release reset voltage | 3.90 | 4.06 | 4.22 | V |
|                          |                    |  |                     | Falling interrupt voltage    | 3.83 | 3.98 | 4.13 | V |

## 3.6.5 Power supply voltage rising slope characteristics

(T<sub>A</sub> = -40 to +105°C, V<sub>SS</sub> = 0 V)

| Parameter                         | Symbol           | Conditions | MIN. | TYP. | MAX. | Unit |
|-----------------------------------|------------------|------------|------|------|------|------|
| Power supply voltage rising slope | S <sub>VDD</sub> |            |      |      | 54   | V/ms |

**Caution** Make sure to keep the internal reset state by the LVD circuit or an external reset until V<sub>DD</sub> reaches the operating voltage range shown in 3.4 AC Characteristics.

## 3.7 LCD Characteristics

## 3.7.1 Resistance division method

## (1) Static display mode

(T<sub>A</sub> = -40 to +105°C, V<sub>L4</sub> (MIN.) ≤ V<sub>DD</sub><sup>Note</sup> ≤ 5.5 V, V<sub>SS</sub> = 0 V)

| Parameter         | Symbol          | Conditions | MIN. | TYP. | MAX.            | Unit |
|-------------------|-----------------|------------|------|------|-----------------|------|
| LCD drive voltage | V <sub>L4</sub> |            | 2.0  |      | V <sub>DD</sub> | V    |

**Note** Must be 2.4 V or higher.

## (2) 1/2 bias method, 1/4 bias method

(T<sub>A</sub> = -40 to +105°C, V<sub>L4</sub> (MIN.) ≤ V<sub>DD</sub> ≤ 5.5 V, V<sub>SS</sub> = 0 V)

| Parameter         | Symbol          | Conditions | MIN. | TYP. | MAX.            | Unit |
|-------------------|-----------------|------------|------|------|-----------------|------|
| LCD drive voltage | V <sub>L4</sub> |            | 2.7  |      | V <sub>DD</sub> | V    |

## (3) 1/3 bias method

(T<sub>A</sub> = -40 to +105°C, V<sub>L4</sub> (MIN.) ≤ V<sub>DD</sub> ≤ 5.5 V, V<sub>SS</sub> = 0 V)

| Parameter         | Symbol          | Conditions | MIN. | TYP. | MAX.            | Unit |
|-------------------|-----------------|------------|------|------|-----------------|------|
| LCD drive voltage | V <sub>L4</sub> |            | 2.5  |      | V <sub>DD</sub> | V    |

## 3.7.2 Internal voltage boosting method

## (1) 1/3 bias method

(T<sub>A</sub> = -40 to +105°C, 2.4 V ≤ V<sub>DD</sub> ≤ 5.5 V, V<sub>SS</sub> = 0 V)

| Parameter                                      | Symbol              | Conditions                              | MIN.                       | TYP.              | MAX.              | Unit |   |
|--|---------------------|---|----------------------------|-------------------|-------------------|------|---|
| LCD output voltage variation range             | V <sub>L1</sub>     | C1 to C4 <sup>Note 1</sup><br>= 0.47 μF | VLCD = 04H                 | 0.90              | 1.00              | 1.08 | V |
|  |                     |   | VLCD = 05H                 | 0.95              | 1.05              | 1.13 | V |
|  |                     |   | VLCD = 06H                 | 1.00              | 1.10              | 1.18 | V |
|  |                     |   | VLCD = 07H                 | 1.05              | 1.15              | 1.23 | V |
|  |                     |   | VLCD = 08H                 | 1.10              | 1.20              | 1.28 | V |
|  |                     |   | VLCD = 09H                 | 1.15              | 1.25              | 1.33 | V |
|  |                     |   | VLCD = 0AH                 | 1.20              | 1.30              | 1.38 | V |
|  |                     |   | VLCD = 0BH                 | 1.25              | 1.35              | 1.43 | V |
|  |                     |   | VLCD = 0CH                 | 1.30              | 1.40              | 1.48 | V |
|  |                     |   | VLCD = 0DH                 | 1.35              | 1.45              | 1.53 | V |
|  |                     |   | VLCD = 0EH                 | 1.40              | 1.50              | 1.58 | V |
|  |                     |   | VLCD = 0FH                 | 1.45              | 1.55              | 1.63 | V |
|  |                     |   | VLCD = 10H                 | 1.50              | 1.60              | 1.68 | V |
|  |                     |   | VLCD = 11H                 | 1.55              | 1.65              | 1.73 | V |
| VLCD = 12H                                     | 1.60                | 1.70                                    | 1.78                       | V                 |                   |      |   |
| VLCD = 13H                                     | 1.65                | 1.75                                    | 1.83                       | V                 |                   |      |   |
| Doubler output voltage                         | V <sub>L2</sub>     | C1 to C4 <sup>Note 1</sup> = 0.47 μF    | 2 V <sub>L1</sub><br>-0.1  | 2 V <sub>L1</sub> | 2 V <sub>L1</sub> | V    |   |
| Tripler output voltage                         | V <sub>L4</sub>     | C1 to C4 <sup>Note 1</sup> = 0.47 μF    | 3 V <sub>L1</sub><br>-0.15 | 3 V <sub>L1</sub> | 3 V <sub>L1</sub> | V    |   |
| Reference voltage setup time <sup>Note 2</sup> | t <sub>VWAIT1</sub> |   | 5                          |                   |                   | ms   |   |
| Voltage boost wait time <sup>Note 3</sup>      | t <sub>VWAIT2</sub> | C1 to C4 <sup>Note 1</sup> = 0.47 μF    | 500                        |                   |                   | ms   |   |

**Notes** 1. This is a capacitor that is connected between voltage pins used to drive the LCD.

C1: A capacitor connected between CAPH and CAPL

C2: A capacitor connected between V<sub>L1</sub> and GND

C3: A capacitor connected between V<sub>L2</sub> and GND

C4: A capacitor connected between V<sub>L4</sub> and GND

C1 = C2 = C3 = C4 = 0.47 μF ± 30%

- This is the time required to wait from when the reference voltage is specified by using the VLCD register (or when the internal voltage boosting method is selected [by setting the MDSET1 and MDSET0 bits of the LCDM0 register to 01B] if the default value reference voltage is used) until voltage boosting starts (VLCON = 1).
- This is the wait time from when voltage boosting is started (VLCON = 1) until display is enabled (LCDON = 1).



## (2) 1/4 bias method

(T<sub>A</sub> = -40 to +105°C, 2.4 V ≤ V<sub>DD</sub> ≤ 5.5 V, V<sub>SS</sub> = 0 V)

| Parameter                                      | Symbol                            | Conditions                              | MIN.                     | TYP.              | MAX.              | Unit |   |
|--|-----------------------------------|---|--------------------------|-------------------|-------------------|------|---|
| LCD output voltage variation range             | V <sub>L1</sub> <sup>Note 4</sup> | C1 to C5 <sup>Note 1</sup><br>= 0.47 μF | VLCD = 04H               | 0.90              | 1.00              | 1.08 | V |
|  |                                   |   | VLCD = 05H               | 0.95              | 1.05              | 1.13 | V |
|  |                                   |   | VLCD = 06H               | 1.00              | 1.10              | 1.18 | V |
|  |                                   |   | VLCD = 07H               | 1.05              | 1.15              | 1.23 | V |
|  |                                   |   | VLCD = 08H               | 1.10              | 1.20              | 1.28 | V |
|  |                                   |   | VLCD = 09H               | 1.15              | 1.25              | 1.33 | V |
|  |                                   |   | VLCD = 0AH               | 1.20              | 1.30              | 1.38 | V |
|  |                                   |   | VLCD = 0BH               | 1.25              | 1.35              | 1.43 | V |
|  |                                   |   | VLCD = 0CH               | 1.30              | 1.40              | 1.48 | V |
|  |                                   |   | VLCD = 0DH               | 1.35              | 1.45              | 1.53 | V |
|  |                                   |   | VLCD = 0EH               | 1.40              | 1.50              | 1.58 | V |
|  |                                   |   | VLCD = 0FH               | 1.45              | 1.55              | 1.63 | V |
|  |                                   |   | VLCD = 10H               | 1.50              | 1.60              | 1.68 | V |
|  |                                   |   | VLCD = 11H               | 1.55              | 1.65              | 1.73 | V |
| VLCD = 12H                                     | 1.60                              | 1.70                                    | 1.78                     | V                 |                   |      |   |
| VLCD = 13H                                     | 1.65                              | 1.75                                    | 1.83                     | V                 |                   |      |   |
| Doubler output voltage                         | V <sub>L2</sub>                   | C1 to C5 <sup>Note 1</sup> = 0.47 μF    | 2 V <sub>L1</sub> - 0.08 | 2 V <sub>L1</sub> | 2 V <sub>L1</sub> | V    |   |
| Tripler output voltage                         | V <sub>L3</sub>                   | C1 to C5 <sup>Note 1</sup> = 0.47 μF    | 3 V <sub>L1</sub> - 0.12 | 3 V <sub>L1</sub> | 3 V <sub>L1</sub> | V    |   |
| Quadruply output voltage                       | V <sub>L4</sub> <sup>Note 4</sup> | C1 to C5 <sup>Note 1</sup> = 0.47 μF    | 4 V <sub>L1</sub> - 0.16 | 4 V <sub>L1</sub> | 4 V <sub>L1</sub> | V    |   |
| Reference voltage setup time <sup>Note 2</sup> | t <sub>WAIT1</sub>                |   | 5                        |                   |                   | ms   |   |
| Voltage boost wait time <sup>Note 3</sup>      | t <sub>WAIT2</sub>                | C1 to C5 <sup>Note 1</sup> = 0.47 μF    | 500                      |                   |                   | ms   |   |

**Notes 1.** This is a capacitor that is connected between voltage pins used to drive the LCD.

C1: A capacitor connected between CAPH and CAPL

C2: A capacitor connected between V<sub>L1</sub> and GND

C3: A capacitor connected between V<sub>L2</sub> and GND

C4: A capacitor connected between V<sub>L3</sub> and GND

C5: A capacitor connected between V<sub>L4</sub> and GND

C1 = C2 = C3 = C4 = C5 = 0.47 μF ± 30%

- This is the time required to wait from when the reference voltage is specified by using the VLCD register (or when the internal voltage boosting method is selected [by setting the MDSET1 and MDSET0 bits of the LCDM0 register to 01B] if the default value reference voltage is used) until voltage boosting starts (VLCON = 1).
- This is the wait time from when voltage boosting is started (VLCON = 1) until display is enabled (LCDON = 1).
- V<sub>L4</sub> must be 5.5 V or lower.

## 3.7.3 Capacitor split method

**1/3 bias method**(T<sub>A</sub> = -40 to +105°C, 2.4 V ≤ V<sub>DD</sub> ≤ 5.5 V, V<sub>SS</sub> = 0 V)

| Parameter                                   | Symbol            | Conditions                           | MIN.                         | TYP.                | MAX.                         | Unit |
|---|-------------------|--------------------------------------|------------------------------|---------------------|------------------------------|------|
| V <sub>L4</sub> voltage                     | V <sub>L4</sub>   | C1 to C4 = 0.47 μF <sup>Note 2</sup> |                              | V <sub>DD</sub>     |                              | V    |
| V <sub>L2</sub> voltage                     | V <sub>L2</sub>   | C1 to C4 = 0.47 μF <sup>Note 2</sup> | 2/3 V <sub>L4</sub><br>- 0.1 | 2/3 V <sub>L4</sub> | 2/3 V <sub>L4</sub><br>+ 0.1 | V    |
| V <sub>L1</sub> voltage                     | V <sub>L1</sub>   | C1 to C4 = 0.47 μF <sup>Note 2</sup> | 1/3 V <sub>L4</sub><br>- 0.1 | 1/3 V <sub>L4</sub> | 1/3 V <sub>L4</sub><br>+ 0.1 | V    |
| Capacitor split wait time <sup>Note 1</sup> | t <sub>WAIT</sub> |                                      | 100                          |                     |                              | ms   |

**Notes** 1. This is the wait time from when voltage bucking is started (VLCON = 1) until display is enabled (LCDON = 1).

2. This is a capacitor that is connected between voltage pins used to drive the LCD.

C1: A capacitor connected between CAPH and CAPL

C2: A capacitor connected between V<sub>L1</sub> and GND

C3: A capacitor connected between V<sub>L2</sub> and GND

C4: A capacitor connected between V<sub>L4</sub> and GND

C1 = C2 = C3 = C4 = 0.47 μF±30%

### 3.8 RAM Data Retention Characteristics

(T<sub>A</sub> = -40 to +105°C, V<sub>SS</sub> = 0 V)

| Parameter                     | Symbol            | Conditions | MIN.                 | TYP. | MAX. | Unit |
|-------------------------------|-------------------|------------|----------------------|------|------|------|
| Data retention supply voltage | V <sub>DDDR</sub> |            | 1.44 <sup>Note</sup> |      | 5.5  | V    |

**Note** This depends on the POR detection voltage. For a falling voltage, data in RAM are retained until the voltage reaches the level that triggers a POR reset but not once it reaches the level at which a POR reset is generated.

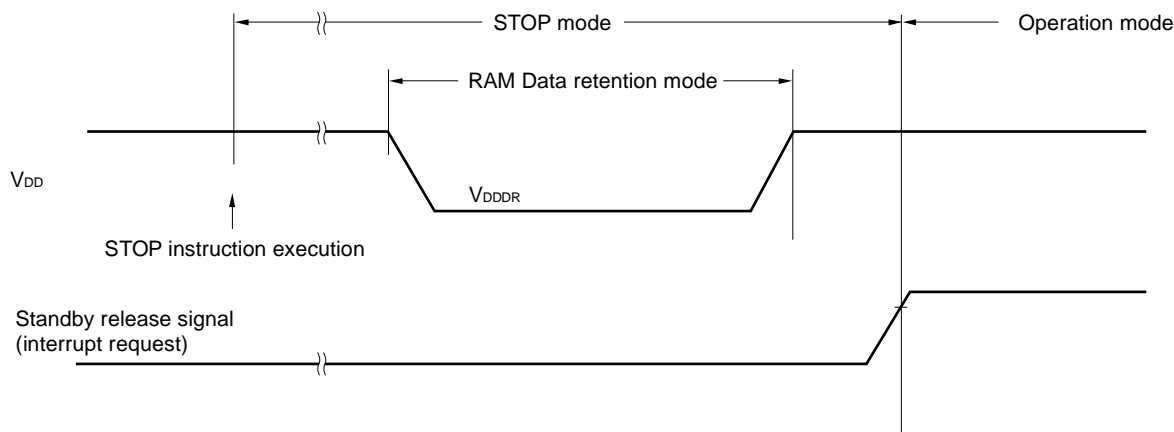

### 3.9 Flash Memory Programming Characteristics

(T<sub>A</sub> = -40 to +105°C, 2.4 V ≤ EV<sub>DD</sub> = V<sub>DD</sub> ≤ 5.5 V, V<sub>SS</sub> = EV<sub>SS</sub> = 0 V)

| Parameter   | Symbol            | Conditions   | MIN.    | TYP.      | MAX. | Unit  |
|---|-------------------|--|---------|-----------|------|-------|
| System clock frequency  | f <sub>CLK</sub>  | 1.8 V ≤ V <sub>DD</sub> ≤ 5.5 V                                  | 1       |           | 24   | MHz   |
| Number of code flash rewrites<br><small>Notes 1, 2, 3</small> | C <sub>enwr</sub> | Retained for 20 years<br>T <sub>A</sub> = 85°C <sup>Note 4</sup> | 1,000   |           |      | Times |
| Number of data flash rewrites<br><small>Notes 1, 2, 3</small> |                   | Retained for 1 year<br>T <sub>A</sub> = 25°C <sup>Note 4</sup>   |         | 1,000,000 |      |       |
|   |                   | Retained for 5 years<br>T <sub>A</sub> = 85°C <sup>Note 4</sup>  | 100,000 |           |      |       |
|   |                   | Retained for 20 years<br>T <sub>A</sub> = 85°C <sup>Note 4</sup> | 10,000  |           |      |       |

- Notes**
- 1 erase + 1 write after the erase is regarded as 1 rewrite.  
The retaining years are until next rewrite after the rewrite.
  2. When using flash memory programmer and Renesas Electronics self programming library
  3. This characteristic indicates the flash memory characteristic and based on Renesas Electronics reliability test.
  4. This temperature is the average value at which data are retained.

### 3.10 Dedicated Flash Memory Programmer Communication (UART)

(T<sub>A</sub> = -40 to +105°C, 2.4 V ≤ EV<sub>DD</sub> = V<sub>DD</sub> ≤ 5.5 V, V<sub>SS</sub> = EV<sub>SS</sub> = 0 V)

| Parameter     | Symbol | Conditions                      | MIN.    | TYP. | MAX.      | Unit |
|---------------|--------|---------------------------------|---------|------|-----------|------|
| Transfer rate |        | During flash memory programming | 115,200 |      | 1,000,000 | bps  |

### 3.11 Timing Specifications for Switching Flash Memory Programming Modes

(T<sub>A</sub> = -40 to +105°C, 2.4 V ≤ V<sub>DD</sub> = V<sub>DD</sub> ≤ 5.5 V, V<sub>SS</sub> = EV<sub>SS</sub> = 0 V)

| Parameter  | Symbol              | Conditions  | MIN. | TYP. | MAX. | Unit |
|--|---------------------|---|------|------|------|------|
| Time to complete the communication for the initial setting after the external reset is released  | t <sub>SUINIT</sub> | POR and LVD reset must be released before the external reset is released. |      |      | 100  | ms   |
| Time to release the external reset after the TOOL0 pin is set to the low level   | t <sub>SU</sub>     | POR and LVD reset must be released before the external reset is released. | 10   |      |      | μs   |
| Time to hold the TOOL0 pin at the low level after the external reset is released (excluding the processing time of the firmware to control the flash memory) | t <sub>HD</sub>     | POR and LVD reset must be released before the external reset is released. | 1    |      |      | ms   |

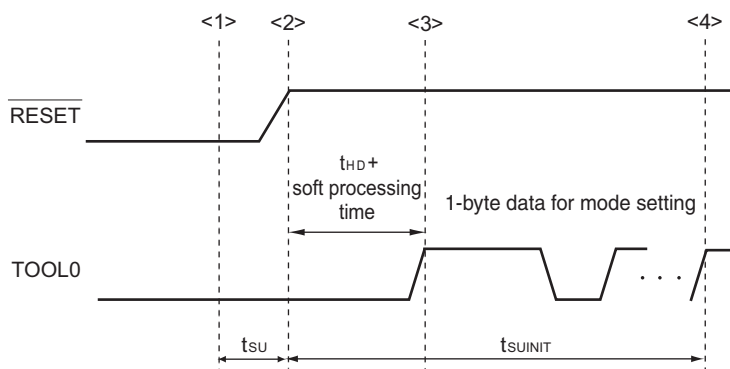

- <1> The low level is input to the TOOL0 pin.
- <2> The external reset is released (POR and LVD reset must be released before the external reset is released.).
- <3> The TOOL0 pin is set to the high level.
- <4> Setting of the flash memory programming mode by UART reception and complete the baud rate setting.

**Remark** t<sub>SUINIT</sub>: Communication for the initial setting must be completed within 100 ms after the external reset is released during this period.

t<sub>SU</sub>: Time to release the external reset after the TOOL0 pin is set to the low level

t<sub>HD</sub>: Time to hold the TOOL0 pin at the low level after the external reset is released (excluding the processing time of the firmware to control the flash memory)

### 4. PACKAGE DRAWINGS

#### 4.1 32-pin Package

|                    |              |                |                 |
|--------------------|--------------|----------------|-----------------|
| JEITA Package Code | RENESAS Code | Previous Code  | MASS (TYP.) [g] |
| P-LQFP32-7x7-0.80  | PLQP0032GB-A | P32GA-80-GBT-1 | 0.2             |

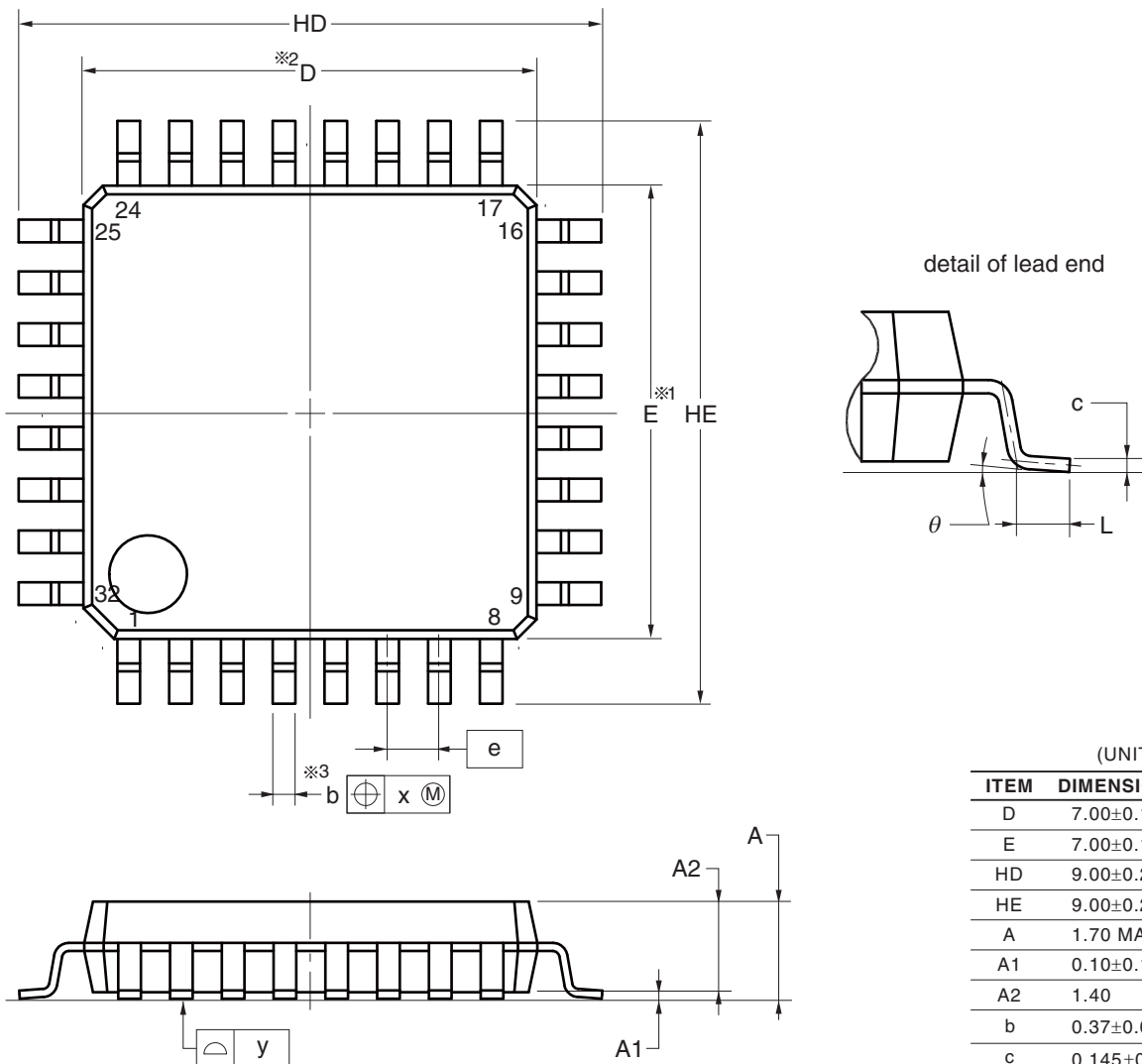

(UNIT:mm)

| ITEM     | DIMENSIONS  |
|----------|-------------|
| D        | 7.00±0.10   |
| E        | 7.00±0.10   |
| HD       | 9.00±0.20   |
| HE       | 9.00±0.20   |
| A        | 1.70 MAX.   |
| A1       | 0.10±0.10   |
| A2       | 1.40        |
| b        | 0.37±0.05   |
| c        | 0.145±0.055 |
| L        | 0.50±0.20   |
| $\theta$ | 0° to 8°    |
| e        | 0.80        |
| x        | 0.20        |
| y        | 0.10        |

**NOTE**

1. Dimensions “ $\ast 1$ ” and “ $\ast 2$ ” do not include mold flash.
2. Dimension “ $\ast 3$ ” does not include trim offset.

4.2 44-pin Package

|                     |              |                |                 |
|---------------------|--------------|----------------|-----------------|
| JEITA Package Code  | RENESAS Code | Previous Code  | MASS (TYP.) [g] |
| P-LQFP44-10x10-0.80 | PLQP0044GC-A | P44GB-80-UES-2 | 0.36            |

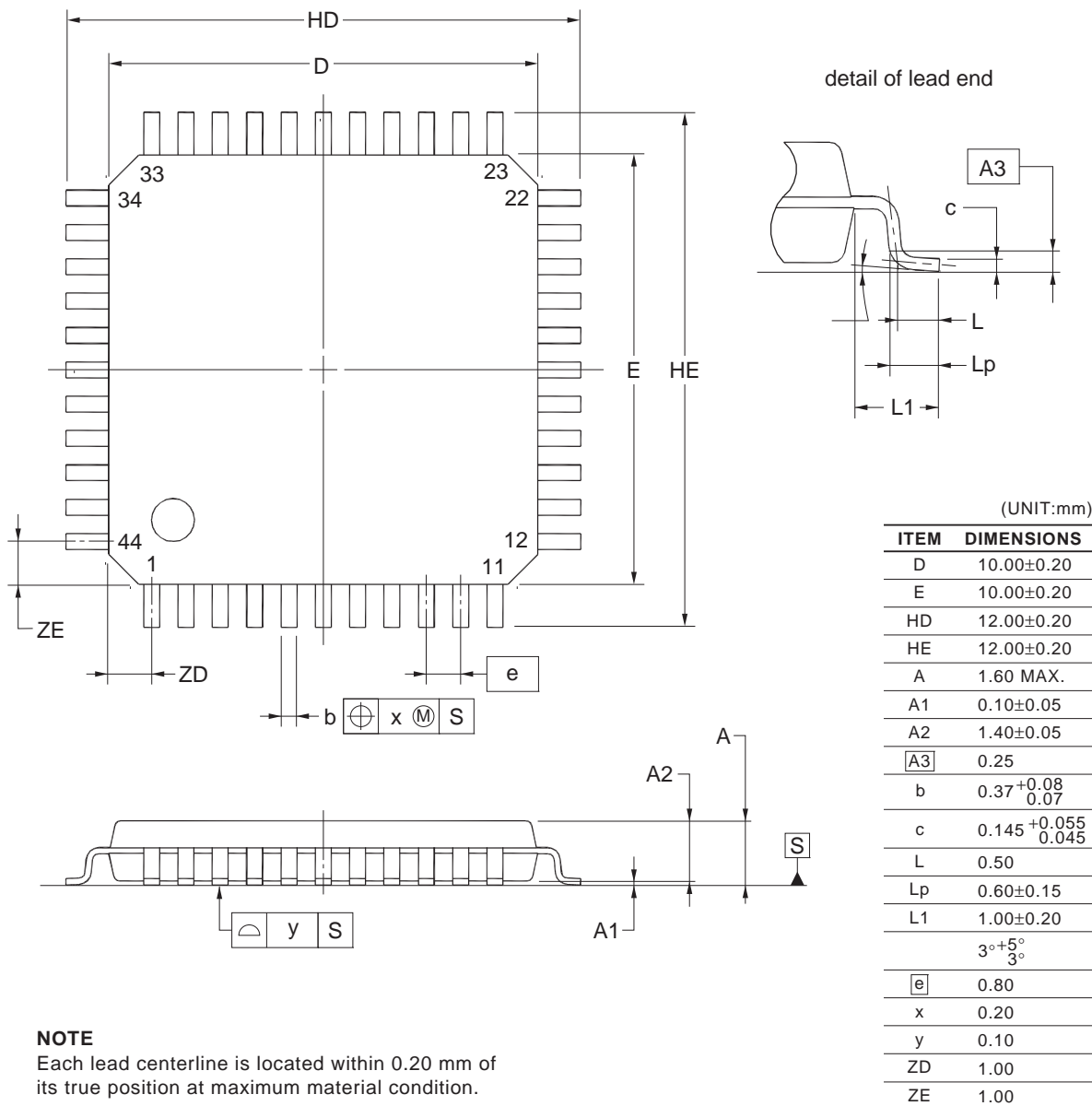

**NOTE**  
Each lead centerline is located within 0.20 mm of its true position at maximum material condition.

|                     |              |               |            |
|---------------------|--------------|---------------|------------|
| JEITA Package Code  | RENESAS Code | Previous Code | MASS[Typ.] |
| P-LQFP44-10x10-0.80 | PLQP0044GC-D | —             | 0.36g      |

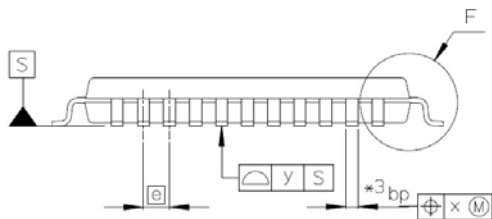
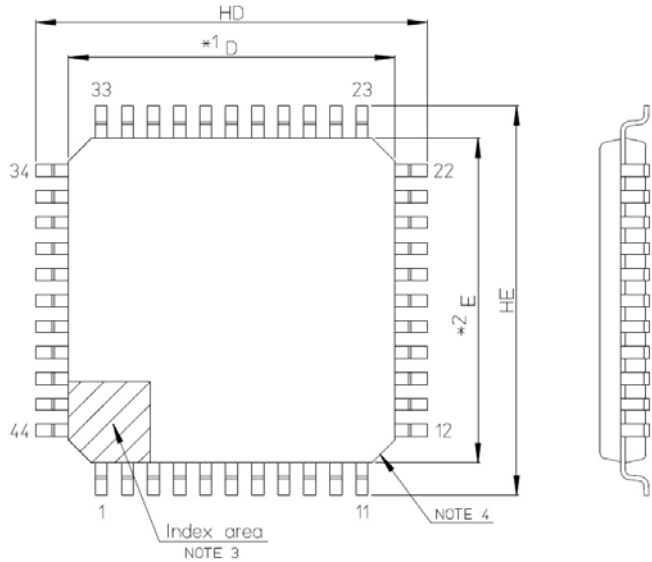

- NOTE)
1. DIMENSIONS \*1 AND \*2 DO NOT INCLUDE MOLD FLASH.
  2. DIMENSION \*3 DOES NOT INCLUDE TRIM OFFSET.
  3. PIN 1 VISUAL INDEX FEATURE MAY VARY, BUT MUST BE LOCATED WITHIN THE HATCHED AREA.
  4. CHAMFERS AT CORNERS ARE OPTIONAL; SIZE MAY VARY.

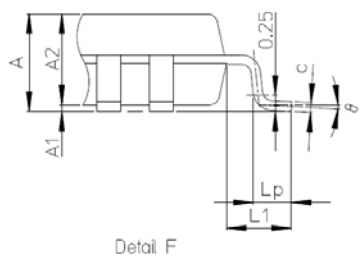

| Reference Symbol | Dimension in Millimeters |      |      |
|------------------|--------------------------|------|------|
|                  | Min                      | Nom  | Max  |
| D                | 9.8                      | 10.0 | 10.2 |
| E                | 9.8                      | 10.0 | 10.2 |
| A2               | —                        | 1.4  | —    |
| HD               | 11.8                     | 12.0 | 12.2 |
| HE               | 11.8                     | 12.0 | 12.2 |
| A                | —                        | —    | 1.6  |
| A1               | 0.05                     | —    | 0.15 |
| bp               | 0.22                     | 0.37 | 0.45 |
| c                | 0.09                     | —    | 0.20 |
| ∅                | 0°                       | 3.5° | 8°   |
| e                | —                        | 0.80 | —    |
| x                | —                        | —    | 0.20 |
| y                | —                        | —    | 0.10 |
| Lp               | 0.45                     | 0.6  | 0.75 |
| L1               | —                        | 1.0  | —    |

4.3 48-pin Package

|                    |              |                |                 |
|--------------------|--------------|----------------|-----------------|
| JEITA Package Code | RENESAS Code | Previous Code  | MASS (TYP.) [g] |
| P-LFQFP48-7x7-0.50 | PLQP0048KF-A | P48GA-50-8EU-1 | 0.16            |

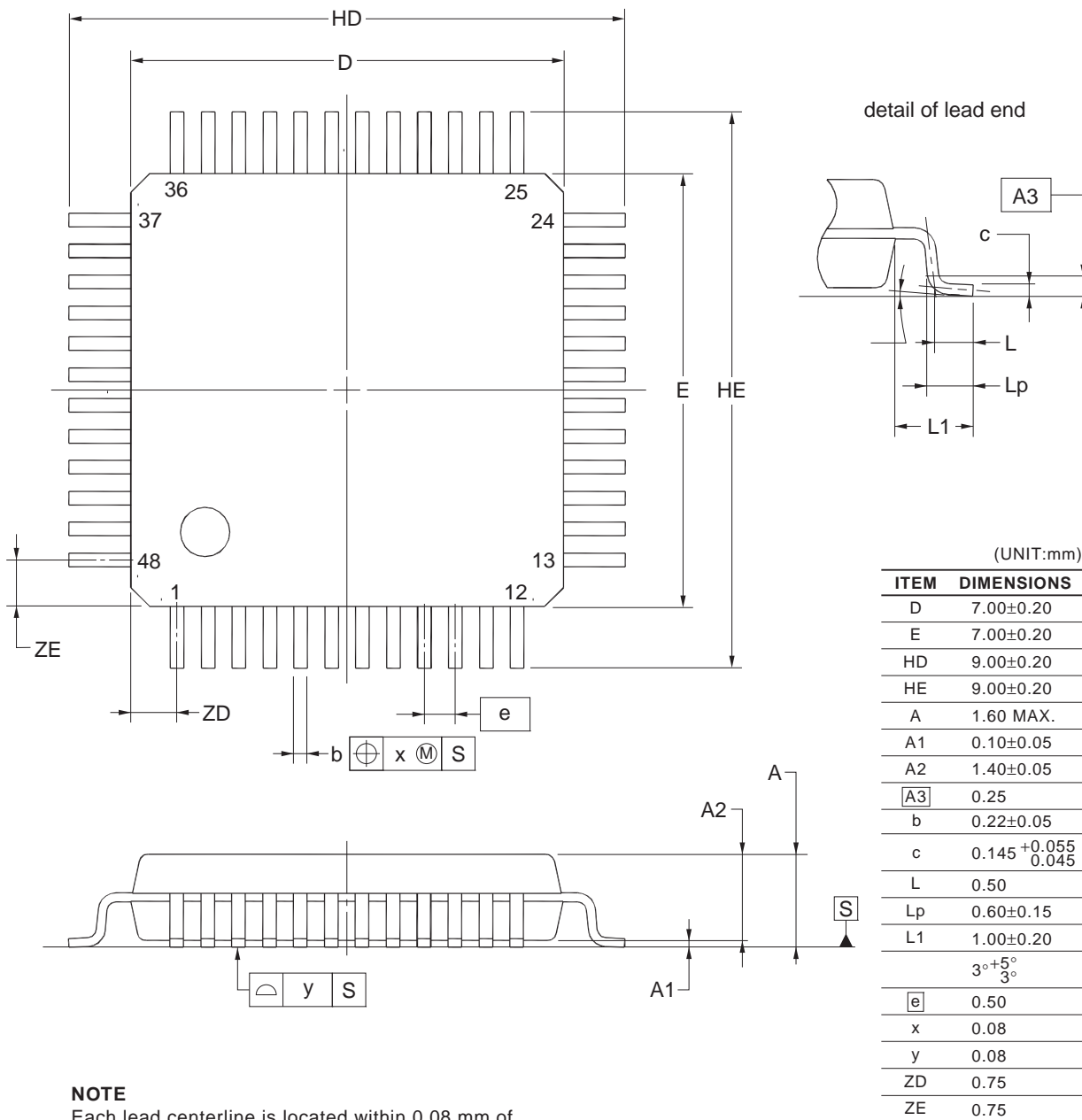

**NOTE**  
 Each lead centerline is located within 0.08 mm of its true position at maximum material condition.



| JEITA Package Code | RENESAS Code | Previous Code | MASS (Typ) [g] |
|--------------------|--------------|---------------|----------------|
| P-LFQFP48-7x7-0.50 | PLQP0048KB-B | —             | 0.2            |

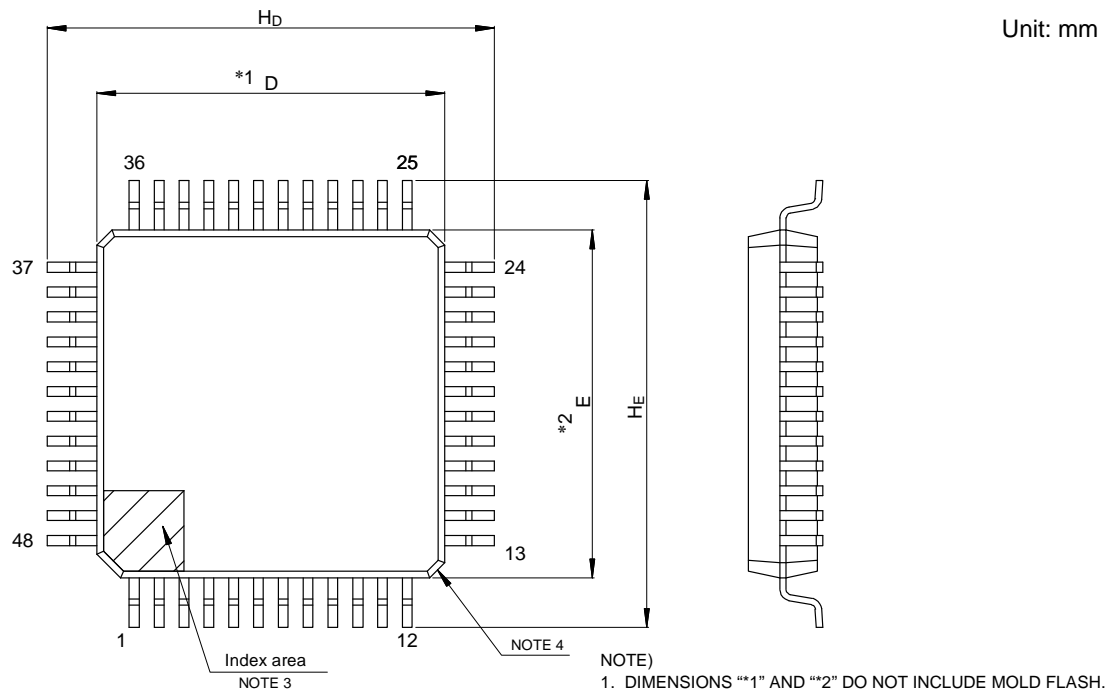

- NOTE)
1. DIMENSIONS “\*1” AND “\*2” DO NOT INCLUDE MOLD FLASH.
  2. DIMENSION “\*3” DOES NOT INCLUDE TRIM OFFSET.
  3. PIN 1 VISUAL INDEX FEATURE MAY VARY, BUT MUST BE LOCATED WITHIN THE HATCHED AREA.
  4. CHAMFERS AT CORNERS ARE OPTIONAL, SIZE MAY VARY.

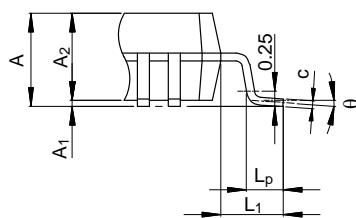
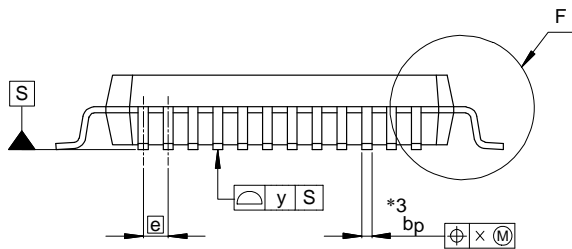

Detail F

| Reference Symbol | Dimensions in millimeters |      |      |
|------------------|---------------------------|------|------|
|                  | Min                       | Nom  | Max  |
| D                | 6.9                       | 7.0  | 7.1  |
| E                | 6.9                       | 7.0  | 7.1  |
| A <sub>2</sub>   | —                         | 1.4  | —    |
| H <sub>D</sub>   | 8.8                       | 9.0  | 9.2  |
| H <sub>E</sub>   | 8.8                       | 9.0  | 9.2  |
| A                | —                         | —    | 1.7  |
| A <sub>1</sub>   | 0.05                      | —    | 0.15 |
| b <sub>p</sub>   | 0.17                      | 0.20 | 0.27 |
| c                | 0.09                      | —    | 0.20 |
| θ                | 0°                        | 3.5° | 8°   |
| e                | —                         | 0.5  | —    |
| x                | —                         | —    | 0.08 |
| y                | —                         | —    | 0.08 |
| L <sub>p</sub>   | 0.45                      | 0.6  | 0.75 |
| L <sub>1</sub>   | —                         | 1.0  | —    |

© 2015 Renesas Electronics Corporation. All rights reserved.

4.4 52-pin Package

|                     |              |                |                 |
|---------------------|--------------|----------------|-----------------|
| JEITA Package Code  | RENESAS Code | Previous Code  | MASS (TYP.) [g] |
| P-LQFP52-10x10-0.65 | PLQP0052JA-A | P52GB-65-GBS-1 | 0.3             |

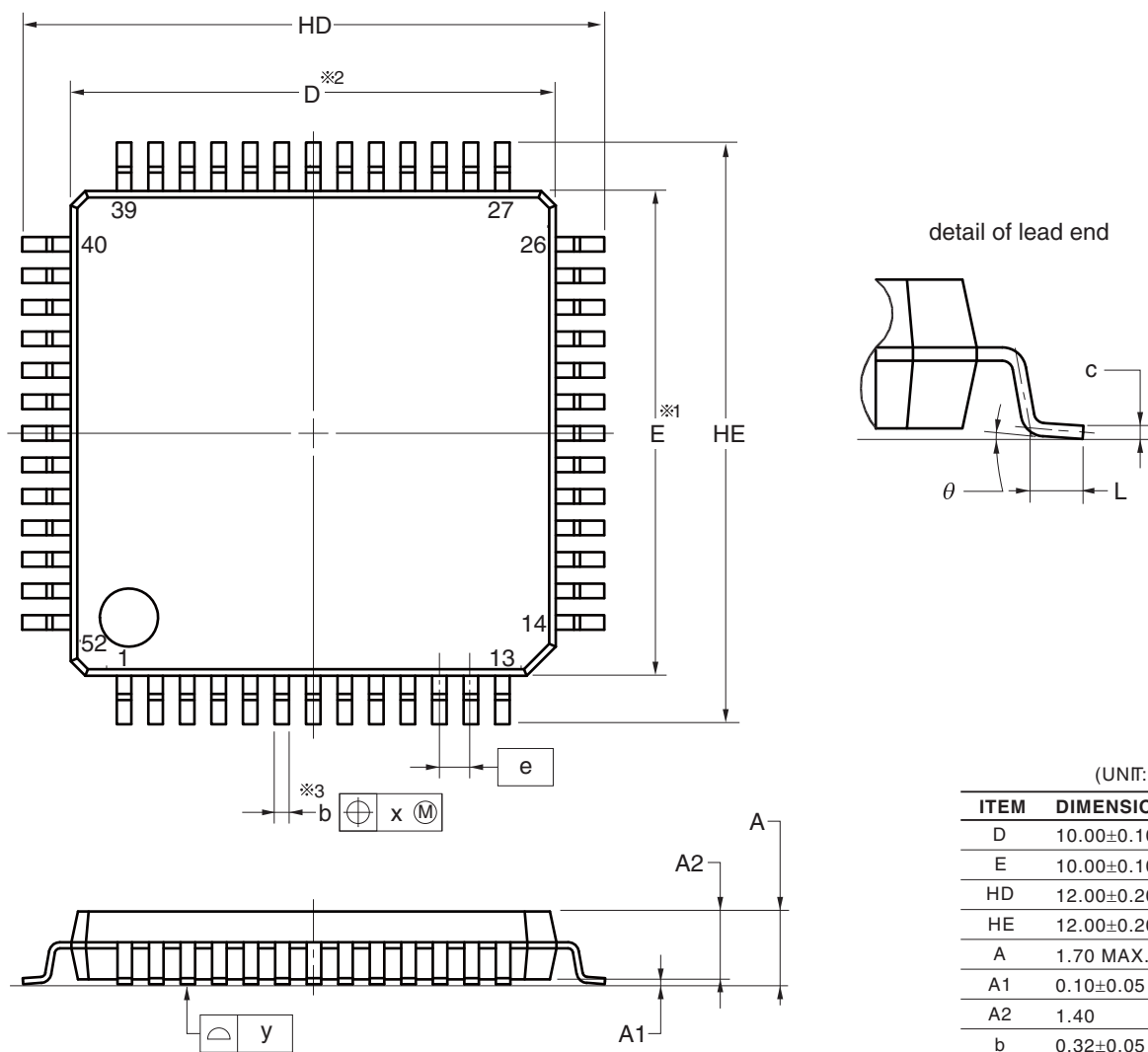

**NOTE**1. Dimensions “\*1” and “\*2” do not include mold flash.  
 2. Dimension “\*3” does not include trim offset.

(UNIT:mm)

| ITEM     | DIMENSIONS  |
|----------|-------------|
| D        | 10.00±0.10  |
| E        | 10.00±0.10  |
| HD       | 12.00±0.20  |
| HE       | 12.00±0.20  |
| A        | 1.70 MAX.   |
| A1       | 0.10±0.05   |
| A2       | 1.40        |
| b        | 0.32±0.05   |
| c        | 0.145±0.055 |
| L        | 0.50±0.15   |
| $\theta$ | 0° to 8°    |
| e        | 0.65        |
| x        | 0.13        |
| y        | 0.10        |

© 2012 Renesas Electronics Corporation. All rights reserved.

4.5 64-pin Package

|                     |              |                |                 |
|---------------------|--------------|----------------|-----------------|
| JEITA Package Code  | RENESAS Code | Previous Code  | MASS (TYP.) [g] |
| P-LQFP64-12x12-0.65 | PLQP0064JA-A | P64GK-65-UET-2 | 0.51            |

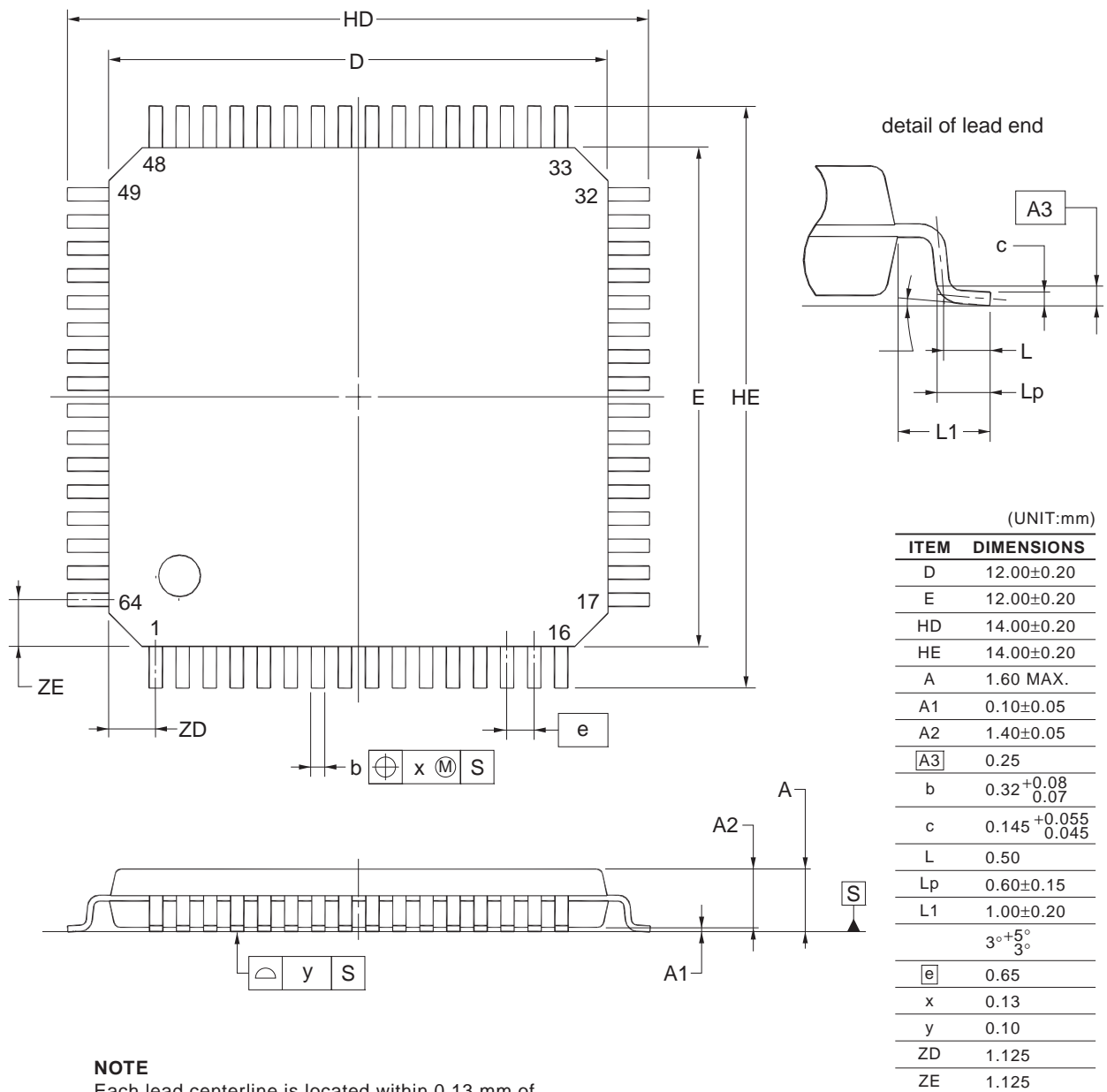

|                      |              |                |                 |
|----------------------|--------------|----------------|-----------------|
| JEITA Package Code   | RENESAS Code | Previous Code  | MASS (TYP.) [g] |
| P-LFQFP64-10x10-0.50 | PLQP0064KF-A | P64GB-50-UEU-2 | 0.35            |

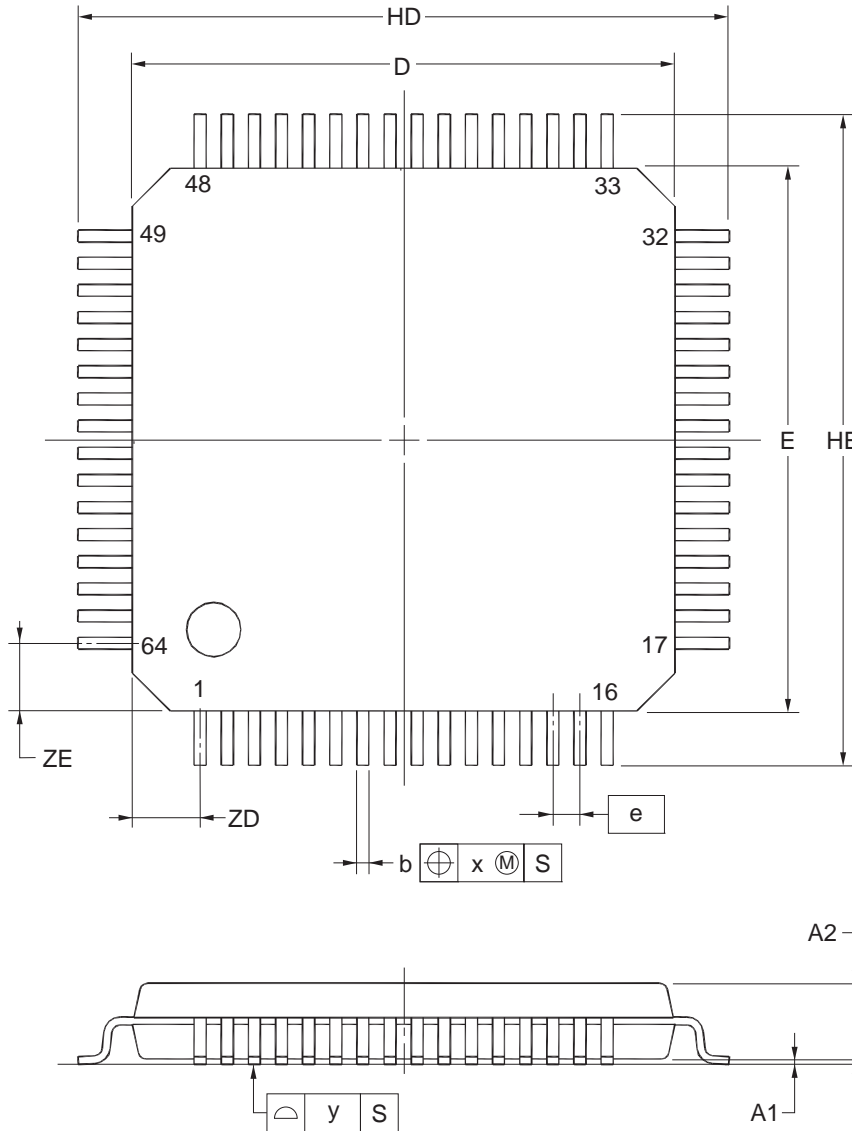

(UNIT:mm)

| ITEM | DIMENSIONS                               |
|------|--|
| D    | 10.00±0.20                               |
| E    | 10.00±0.20                               |
| HD   | 12.00±0.20                               |
| HE   | 12.00±0.20                               |
| A    | 1.60 MAX.                                |
| A1   | 0.10±0.05                                |
| A2   | 1.40±0.05                                |
| A3   | 0.25                                     |
| b    | 0.22±0.05                                |
| c    | 0.145 <sup>+0.055</sup> <sub>0.045</sub> |
| L    | 0.50                                     |
| Lp   | 0.60±0.15                                |
| L1   | 1.00±0.20                                |
|      | 3°+5°<br>3°                              |
| e    | 0.50                                     |
| x    | 0.08                                     |
| y    | 0.08                                     |
| ZD   | 1.25                                     |
| ZE   | 1.25                                     |

**NOTE**

Each lead centerline is located within 0.08 mm of its true position at maximum material condition.

©2012 Renesas Electronics Corporation. All rights reserved.

| JEITA Package Code   | RENESAS Code | Previous Code | MASS (Typ) [g] |
|----------------------|--------------|---------------|----------------|
| P-LFQFP64-10x10-0.50 | PLQP0064KB-C | —             | 0.3            |

Unit: mm

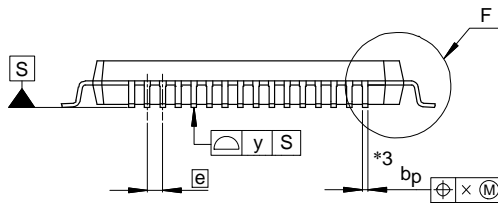
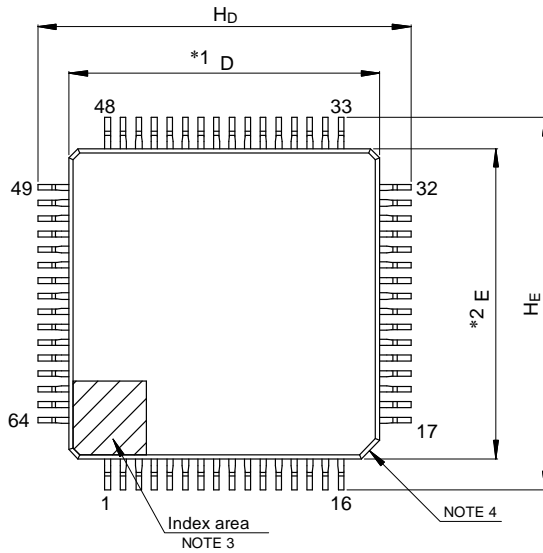

NOTE)

1. DIMENSIONS  $*1$  AND  $*2$  DO NOT INCLUDE MOLD FLASH.
2. DIMENSION  $*3$  DOES NOT INCLUDE TRIM OFFSET.
3. PIN 1 VISUAL INDEX FEATURE MAY VARY, BUT MUST BE LOCATED WITHIN THE HATCHED AREA.
4. CHAMFERS AT CORNERS ARE OPTIONAL, SIZE MAY VARY.

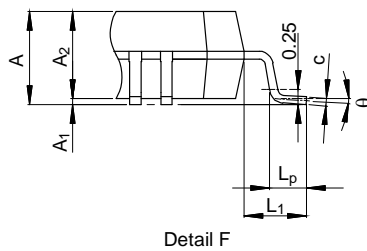

| Reference Symbol | Dimensions in millimeters |      |      |
|------------------|---------------------------|------|------|
|                  | Min                       | Nom  | Max  |
| D                | 9.9                       | 10.0 | 10.1 |
| E                | 9.9                       | 10.0 | 10.1 |
| $A_2$            | —                         | 1.4  | —    |
| $H_D$            | 11.8                      | 12.0 | 12.2 |
| $H_E$            | 11.8                      | 12.0 | 12.2 |
| A                | —                         | —    | 1.7  |
| $A_1$            | 0.05                      | —    | 0.15 |
| $b_p$            | 0.15                      | 0.20 | 0.27 |
| c                | 0.09                      | —    | 0.20 |
| $\theta$         | 0°                        | 3.5° | 8°   |
| $\text{[e]}$     | —                         | 0.5  | —    |
| x                | —                         | —    | 0.08 |
| y                | —                         | —    | 0.08 |
| $L_p$            | 0.45                      | 0.6  | 0.75 |
| $L_1$            | —                         | 1.0  | —    |

© 2015 Renesas Electronics Corporation. All rights reserved.

| JEITA Package Code | RENESAS Code | Previous Code  | MASS (Typ) [g] |
|--------------------|--------------|----------------|----------------|
| P-HWQFN64-8x8-0.40 | PWQN0064LA-A | P64K8-40-9B5-4 | 0.16           |

Unit: mm

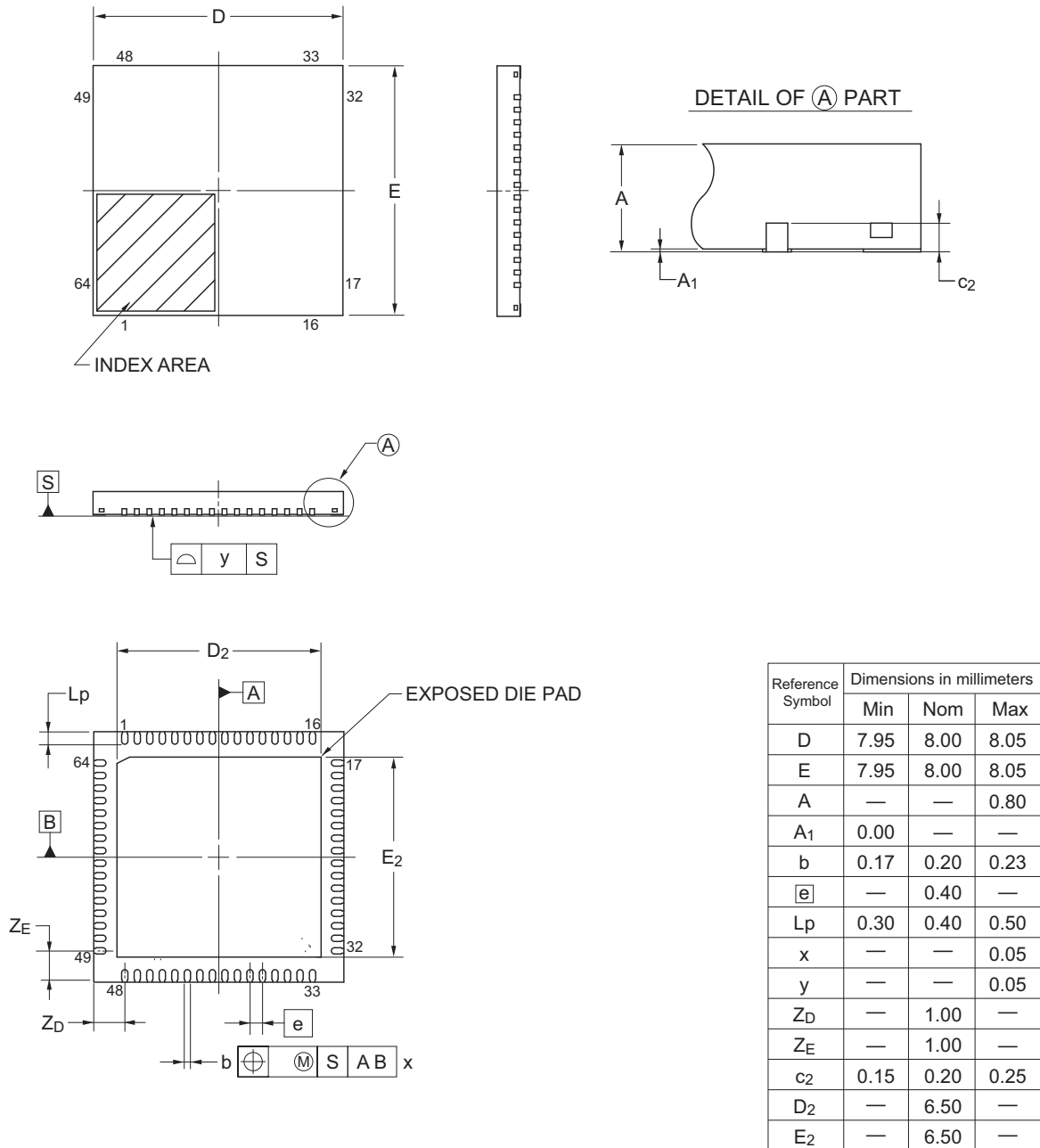

© 2015 Renesas Electronics Corporation. All rights reserved.

<R>

|                     |              |               |
|---------------------|--------------|---------------|
| JEITA Package code  | RENESAS code | MASS(TYP.)[g] |
| P-HWQFN064-8x8-0.40 | PWQN0064LB-A | 0.18          |

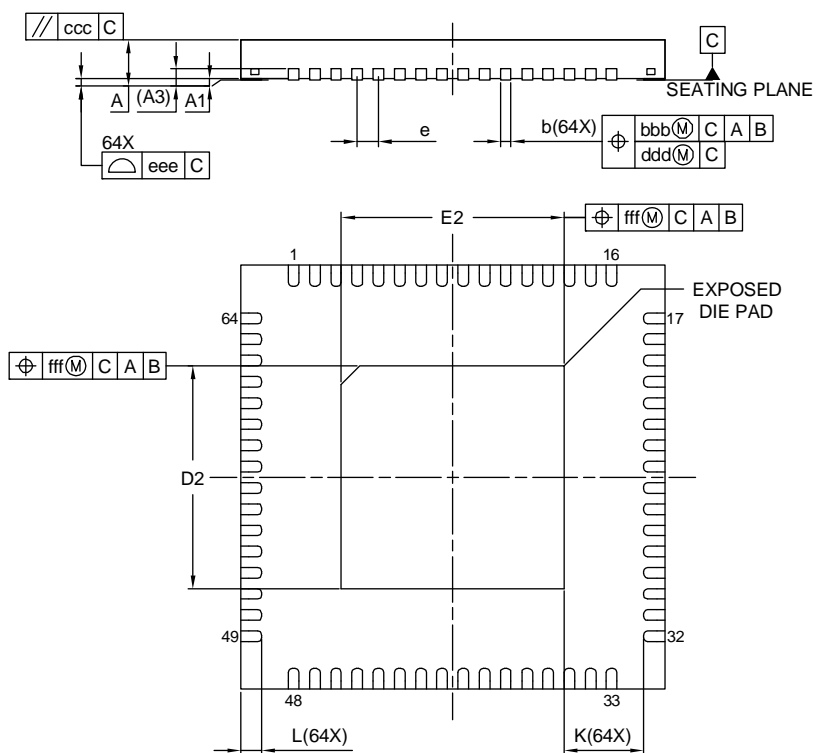
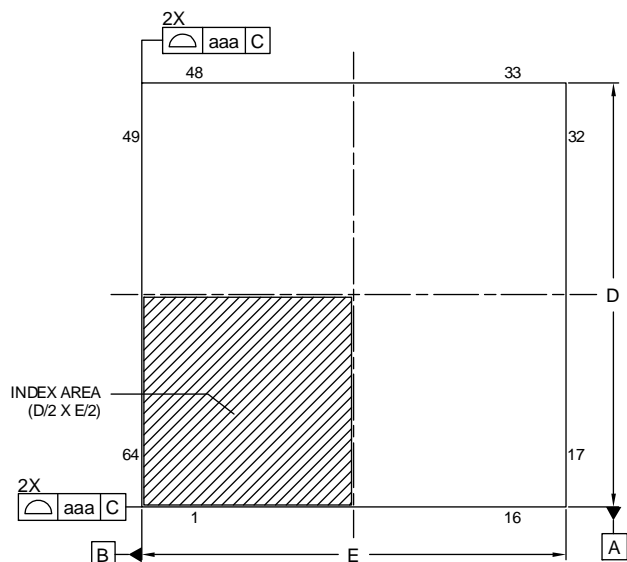

| Reference Symbol | Dimension in Millimeters |      |      |
|------------------|--------------------------|------|------|
|                  | Min.                     | Nom. | Max. |
| A                | —                        | —    | 0.80 |
| A <sub>1</sub>   | 0.00                     | 0.02 | 0.05 |
| A <sub>3</sub>   | 0.203 REF.               |      |      |
| b                | 0.15                     | 0.20 | 0.25 |
| D                | 8.00 BSC                 |      |      |
| E                | 8.00 BSC                 |      |      |
| e                | 0.40 BSC                 |      |      |
| L                | 0.35                     | 0.40 | 0.45 |
| K                | 0.20                     | —    | —    |
| D <sub>2</sub>   | 4.15                     | 4.20 | 4.25 |
| E <sub>2</sub>   | 4.15                     | 4.20 | 4.25 |
| aaa              | 0.10                     |      |      |
| bbb              | 0.07                     |      |      |
| ccc              | 0.10                     |      |      |
| ddd              | 0.05                     |      |      |
| eee              | 0.08                     |      |      |
| fff              | 0.10                     |      |      |

## Revision History

## RL78/L12 Datasheet

| Rev.     | Date  | Description                              |   |
|----------|---|--|---|
|          |   | Page                                     | Summary   |
| 0.01     | Feb 20, 2012  | -  | First Edition issued  |
| 0.02     | Sep 26, 2012  | 7, 8                                     | Modification of caution 2 in 1.3.5 64-pin products  |
|          |   | 15                                       | Modification of I/O port in 1.6 Outline of Functions  |
|          |   | -  | Modification of 2. ELECTRICAL SPECIFICATIONS (TARGET)   |
|          |   | -  | Update of package drawings in 3. PACKAGE DRAWINGS   |
| 1.00     | Jan 31, 2013  | 11 to 15                                 | Modification of 1.5 Block Diagram   |
|          |   | 16                                       | Modification of Note 2 in 1.6 Outline of Functions  |
|          |   | 17                                       | Modification of 1.6 Outline of Functions  |
|          |   | -  | Deletion of target in 2. ELECTRICAL SPECIFICATIONS  |
|          |   | 18                                       | Addition of caution 2 to 2. ELECTRICAL SPECIFICATIONS   |
|          |   | 19                                       | Addition of description, note 3, and remark 2 to 2.1 Absolute Maximum Ratings                       |
|          |   | 20                                       | Modification of description and addition of note to 2.1 Absolute Maximum Ratings                    |
|          |   | 22, 23                                   | Modification of 2.2 Oscillator Characteristics  |
|          |   | 30                                       | Modification of notes 1 to 4 in 2.3.2 Supply current characteristics                                |
|          |   | 32                                       | Modification of notes 1, 3 to 6, 8 in 2.3.2 Supply current characteristics                          |
|          |   | 34                                       | Modification of notes 7, 9, 11, and addition of notes 8, 12 to 2.3.2 Supply current characteristics |
|          |   | 36                                       | Addition of description to 2.4 AC Characteristics   |
|          |   | 38, 40 to 42, 44 to 46, 48 to 52, 54, 55 | Modification of 2.5.1 Serial array unit   |
|          |   | 57, 58                                   | Modification of 2.5.2 Serial interface IICA   |
|          |   | 62                                       | Modification of 2.6.2 Temperature sensor/internal reference voltage characteristics                 |
|          |   | 64                                       | Addition of note and caution in 2.6.5 Supply voltage rise time                                      |
|          |   | 69                                       | Modification of 2.8 Data Memory STOP Mode Low Supply Voltage Data Retention Characteristics         |
|          |   | 69                                       | Modification of conditions in 2.9 Timing Specs for Switching Flash Memory Programming Modes         |
|          |   | 70                                       | Modification of 2.10 Timing Specifications for Switching Flash Memory Programming Modes             |
|          |   | 2.00                                     | Jan 10, 2014  |
| 3        | Modification of Figure 1-1  |  |   |
| 4        | Modification of part number, note, and caution  |  |   |
| 5 to 10  | Deletion of COMEXP pin in 1.3.1 to 1.3.5.   |  |   |
| 11       | Modification of description in 1.4 Pin Identification   |  |   |
| 12 to 16 | Deletion of COMEXP pin in 1.5.1 to 1.5.5  |  |   |
| 17       | Modification of table and note 2 in 1.6 Outline of Functions  |  |   |
| 20       | Modification of description in Absolute Maximum Ratings ( $T_A = 25^\circ\text{C}$ ) (1/3)            |  |   |
| 21       | Modification of description and note 2 in Absolute Maximum Ratings ( $T_A = 25^\circ\text{C}$ ) (2/3) |  |   |
| 23       | Modification of table, note, caution, and remark in 2.2.1 X1, XT1 oscillator characteristics          |  |   |
| 23       | Modification of table in 2.2.2 On-chip oscillator characteristics                                     |  |   |
| 24       | Modification of table, notes 2 and 3 in 2.3.1 Pin characteristics (1/5)                               |  |   |
| 25       | Modification of notes 1 and 3 in 2.3.1 Pin characteristics (2/5)                                      |  |   |
| 30       | Modification of notes 1 and 4 in 2.3.2 Supply current characteristics (1/3)                           |  |   |
| 31, 32   | Modification of table, notes 1, 5, and 6 in 2.3.2 Supply current characteristics (2/3)                |  |   |
| 33, 34   | Modification of table, notes 1, 3, 4, and 5 to 10 in 2.3.2 Supply current characteristics (3/3)       |  |   |



| Rev.  | Date   | Description |  |   |  |
|-------|--|-------------|--|---|--|
|       |  | Page        | Summary  |   |  |
| 2.00  | Jan 10, 2014   | 35          | Modification of table in 2.4 AC Characteristics  |   |  |
|       |  | 36          | Addition of Minimum Instruction Execution Time during Main System Clock Operation  |   |  |
|       |  | 37          | Modification of AC Timing Test Points and External System Clock Timing   |   |  |
|       |  | 39          | Modification of AC Timing Test Points  |   |  |
|       |  | 39          | Modification of description, notes 1 and 2 in (1) During communication at same potential (UART mode)                                       |   |  |
|       |  | 41, 42      | Modification of description, remark 2 in (2) During communication at same potential (CSI mode)   |   |  |
|       |  | 42, 43      | Modification of description in (3) During communication at same potential (CSI mode)   |   |  |
|       |  | 45          | Modification of description, notes 1 and 3, and remark 3 in (4) Communication at different potential (1.8 V, 2.5 V, 3 V) (UART mode) (1/2) |   |  |
|       |  | 46, 48      | Modification of description, and remark 3 in (4) Communication at different potential (1.8 V, 2.5 V, 3 V) (UART mode) (2/2)                |   |  |
|       |  | 49, 50      | Modification of table, and note 1, caution, and remark 3 in (5) Communication at different potential (2.5 V, 3 V) (CSI mode)               |   |  |
|       |  | 51          | Modification of table and note in (6) Communication at different potential (1.8 V, 2.5 V, 3 V) (1/3)                                       |   |  |
|       |  | 52          | Modification of table and notes 1 to 3 in (6) Communication at different potential (1.8 V, 2.5 V, 3 V) (2/3)                               |   |  |
|       |  | 53, 54      | Modification of table, note 3, and remark 3 in (6) Communication at different potential (1.8 V, 2.5 V, 3 V) (3/3)                          |   |  |
|       |  | 56          | Modification of table in (7) Communication at different potential (1.8 V, 2.5 V, 3 V) (CSI mode) (1/2)                                     |   |  |
|       |  | 57          | Modification of table in (7) Communication at different potential (1.8 V, 2.5 V, 3 V) (CSI mode) (2/2)                                     |   |  |
|       |  | 59, 60      | Addition of (1) I <sup>2</sup> C standard mode   |   |  |
|       |  | 61          | Addition of (2) I <sup>2</sup> C fast mode   |   |  |
|       |  | 62          | Addition of (3) I <sup>2</sup> C fast mode plus  |   |  |
|       |  | 63          | Addition of table in 2.6.1 A/D converter characteristics   |   |  |
|       |  | 63, 64      | Modification of description and notes 3 to 5 in 2.6.1 (1)  |   |  |
|       |  | 65          | Modification of description, notes 3 and 4 in 2.6.1 (2)  |   |  |
|       |  | 66          | Modification of description, notes 3 and 4 in 2.6.1 (3)  |   |  |
|       |  | 67          | Modification of description, notes 3 and 4 in 2.6.1 (4)  |   |  |
|       |  | 67          | Modification of the table in 2.6.2 Temperature sensor/internal reference voltage characteristics   |   |  |
|       |  | 68          | Modification of the table and note in 2.6.3 POR circuit characteristics  |   |  |
|       |  | 70          | Modification of the table of LVD Detection Voltage of Interrupt & Reset Mode   |   |  |
|       |  | 70          | Modification from V <sub>DD</sub> rise slope to Power supply voltage rising slope in 2.6.5 Supply voltage rise time                        |   |  |
|       |  | 75          | Modification of description in 2.10 Dedicated Flash Memory Programmer Communication (UART)   |   |  |
|       |  | 76          | Modification of the figure in 2.11 Timing Specifications for Switching Flash Memory Programming Modes                                      |   |  |
|       |  | 77 to 126   | Addition of products for industrial applications (G: T <sub>A</sub> = -40 to +105°C)   |   |  |
|       |  | 127 to 133  | Addition of product names for industrial applications (G: T <sub>A</sub> = -40 to +105°C)  |   |  |
|       |  | 2.10        | Sep 30, 2016   | 5 | Modification of pin configuration in 1.3.1 32-pin products |
|       |  |             |  | 6 | Modification of pin configuration in 1.3.2 44-pin products |
| 7     | Modification of pin configuration in 1.3.3 48-pin products                                   |             |  |   |  |
| 8     | Modification of pin configuration in 1.3.4 52-pin products                                   |             |  |   |  |
| 9, 10 | Modification of pin configuration in 1.3.5 64-pin products                                   |             |  |   |  |
| 17    | Modification of description of main system clock in 1.6 Outline of Functions                 |             |  |   |  |
| 74    | Modification of title of 2.8 RAM Data Retention Characteristics, Note, and figure            |             |  |   |  |
| 74    | Modification of table of 2.9 Flash Memory Programming Characteristics                        |             |  |   |  |
| 123   | Modification of title of 3.8 RAM Data Retention Characteristics, Note, and figure            |             |  |   |  |
| 123   | Modification of table of 3.9 Flash Memory Programming Characteristics and addition of Note 4 |             |  |   |  |
| 131   | Modification of 4.5 64-pin Products  |             |  |   |  |

| Rev. | Date         | Description                    |  |
|------|--------------|--------------------------------|--|
|      |              | Page                           | Summary  |
| 2.11 | Feb 14, 2020 | 3                              | Addition of packaging specifications in Figure 1-1 Part Number, Memory Size, and Package of RL78/L12 |
|      |              | 4, 5                           | Addition of ordering part numbers and RENESAS codes in Table 1-1 List of Ordering Part Numbers       |
|      |              | 6 to 11                        | Additions of the package size and pin pitch in 1.3 Pin Configuration (Top View)                      |
|      |              | 126, 127, 129, 131 to 133, 135 | Modification of the titles of the subchapters and deletion of product names in Chapter 4             |
|      |              | 128                            | Addition of figure in 4.2 44-pin Package   |
|      |              | 130                            | Addition of figure in 4.3 48-pin Package   |
|      |              | 134                            | Addition of figure in 4.5 64-pin Package   |
| 2.12 | Dec 22, 2020 | 3                              | Modification of Figure 1-1 Part Number, Memory Size, and Package of RL78/L12                         |
|      |              | 4                              | Modification of description in Table 1-1 List of Ordering Part Numbers                               |
|      |              | 135                            | Addition of figure in 4.5 64-pin Package   |

The mark “<R>” shows major revised points. The revised points can be easily searched by copying an “<R>” in the PDF file and specifying it in the “Find what:” field.

All trademarks and registered trademarks are the property of their respective owners.

SuperFlash is a registered trademark of Silicon Storage Technology, Inc. in several countries including the United States and Japan.

|  |
|--|
| Caution: This product uses SuperFlash® technology licensed from Silicon Storage Technology, Inc. |
|--|

# General Precautions in the Handling of Microprocessing Unit and Microcontroller Unit Products

The following usage notes are applicable to all Microprocessing unit and Microcontroller unit products from Renesas. For detailed usage notes on the products covered by this document, refer to the relevant sections of the document as well as any technical updates that have been issued for the products.

## 1. Precaution against Electrostatic Discharge (ESD)

A strong electrical field, when exposed to a CMOS device, can cause destruction of the gate oxide and ultimately degrade the device operation. Steps must be taken to stop the generation of static electricity as much as possible, and quickly dissipate it when it occurs. Environmental control must be adequate. When it is dry, a humidifier should be used. This is recommended to avoid using insulators that can easily build up static electricity.

Semiconductor devices must be stored and transported in an anti-static container, static shielding bag or conductive material. All test and measurement tools including work benches and floors must be grounded. The operator must also be grounded using a wrist strap. Semiconductor devices must not be touched with bare hands. Similar precautions must be taken for printed circuit boards with mounted semiconductor devices.

## 2. Processing at power-on

The state of the product is undefined at the time when power is supplied. The states of internal circuits in the LSI are indeterminate and the states of register settings and pins are undefined at the time when power is supplied. In a finished product where the reset signal is applied to the external reset pin, the states of pins are not guaranteed from the time when power is supplied until the reset process is completed. In a similar way, the states of pins in a product that is reset by an on-chip power-on reset function are not guaranteed from the time when power is supplied until the power reaches the level at which resetting is specified.

## 3. Input of signal during power-off state

Do not input signals or an I/O pull-up power supply while the device is powered off. The current injection that results from input of such a signal or I/O pull-up power supply may cause malfunction and the abnormal current that passes in the device at this time may cause degradation of internal elements. Follow the guideline for input signal during power-off state as described in your product documentation.

## 4. Handling of unused pins

Handle unused pins in accordance with the directions given under handling of unused pins in the manual. The input pins of CMOS products are generally in the high-impedance state. In operation with an unused pin in the open-circuit state, extra electromagnetic noise is induced in the vicinity of the LSI, an associated shoot-through current flows internally, and malfunctions occur due to the false recognition of the pin state as an input signal become possible.

## 5. Clock signals

After applying a reset, only release the reset line after the operating clock signal becomes stable. When switching the clock signal during program execution, wait until the target clock signal is stabilized. When the clock signal is generated with an external resonator or from an external oscillator during a reset, ensure that the reset line is only released after full stabilization of the clock signal. Additionally, when switching to a clock signal produced with an external resonator or by an external oscillator while program execution is in progress, wait until the target clock signal is stable.

## 6. Voltage application waveform at input pin

Waveform distortion due to input noise or a reflected wave may cause malfunction. If the input of the CMOS device stays in the area between  $V_{IL}$  (Max.) and  $V_{IH}$  (Min.) due to noise, for example, the device may malfunction. Take care to prevent chattering noise from entering the device when the input level is fixed, and also in the transition period when the input level passes through the area between  $V_{IL}$  (Max.) and  $V_{IH}$  (Min.).

## 7. Prohibition of access to reserved addresses

Access to reserved addresses is prohibited. The reserved addresses are provided for possible future expansion of functions. Do not access these addresses as the correct operation of the LSI is not guaranteed.

## 8. Differences between products

Before changing from one product to another, for example to a product with a different part number, confirm that the change will not lead to problems. The characteristics of a microprocessing unit or microcontroller unit products in the same group but having a different part number might differ in terms of internal memory capacity, layout pattern, and other factors, which can affect the ranges of electrical characteristics, such as characteristic values, operating margins, immunity to noise, and amount of radiated noise. When changing to a product with a different part number, implement a system-evaluation test for the given product.

## Notice

1. Descriptions of circuits, software and other related information in this document are provided only to illustrate the operation of semiconductor products and application examples. You are fully responsible for the incorporation or any other use of the circuits, software, and information in the design of your product or system. Renesas Electronics disclaims any and all liability for any losses and damages incurred by you or third parties arising from the use of these circuits, software, or information.
  2. Renesas Electronics hereby expressly disclaims any warranties against and liability for infringement or any other claims involving patents, copyrights, or other intellectual property rights of third parties, by or arising from the use of Renesas Electronics products or technical information described in this document, including but not limited to, the product data, drawings, charts, programs, algorithms, and application examples.
  3. No license, express, implied or otherwise, is granted hereby under any patents, copyrights or other intellectual property rights of Renesas Electronics or others.
  4. You shall not alter, modify, copy, or reverse engineer any Renesas Electronics product, whether in whole or in part. Renesas Electronics disclaims any and all liability for any losses or damages incurred by you or third parties arising from such alteration, modification, copying or reverse engineering.
  5. Renesas Electronics products are classified according to the following two quality grades: "Standard" and "High Quality". The intended applications for each Renesas Electronics product depends on the product's quality grade, as indicated below.  
"Standard": Computers; office equipment; communications equipment; test and measurement equipment; audio and visual equipment; home electronic appliances; machine tools; personal electronic equipment; industrial robots; etc.  
"High Quality": Transportation equipment (automobiles, trains, ships, etc.); traffic control (traffic lights); large-scale communication equipment; key financial terminal systems; safety control equipment; etc.  
Unless expressly designated as a high reliability product or a product for harsh environments in a Renesas Electronics data sheet or other Renesas Electronics document, Renesas Electronics products are not intended or authorized for use in products or systems that may pose a direct threat to human life or bodily injury (artificial life support devices or systems; surgical implantations; etc.), or may cause serious property damage (space system; undersea repeaters; nuclear power control systems; aircraft control systems; key plant systems; military equipment; etc.). Renesas Electronics disclaims any and all liability for any damages or losses incurred by you or any third parties arising from the use of any Renesas Electronics product that is inconsistent with any Renesas Electronics data sheet, user's manual or other Renesas Electronics document.
  6. When using Renesas Electronics products, refer to the latest product information (data sheets, user's manuals, application notes, "General Notes for Handling and Using Semiconductor Devices" in the reliability handbook, etc.), and ensure that usage conditions are within the ranges specified by Renesas Electronics with respect to maximum ratings, operating power supply voltage range, heat dissipation characteristics, installation, etc. Renesas Electronics disclaims any and all liability for any malfunctions, failure or accident arising out of the use of Renesas Electronics products outside of such specified ranges.
  7. Although Renesas Electronics endeavors to improve the quality and reliability of Renesas Electronics products, semiconductor products have specific characteristics, such as the occurrence of failure at a certain rate and malfunctions under certain use conditions. Unless designated as a high reliability product or a product for harsh environments in a Renesas Electronics data sheet or other Renesas Electronics document, Renesas Electronics products are not subject to radiation resistance design. You are responsible for implementing safety measures to guard against the possibility of bodily injury, injury or damage caused by fire, and/or danger to the public in the event of a failure or malfunction of Renesas Electronics products, such as safety design for hardware and software, including but not limited to redundancy, fire control and malfunction prevention, appropriate treatment for aging degradation or any other appropriate measures. Because the evaluation of microcomputer software alone is very difficult and impractical, you are responsible for evaluating the safety of the final products or systems manufactured by you.
  8. Please contact a Renesas Electronics sales office for details as to environmental matters such as the environmental compatibility of each Renesas Electronics product. You are responsible for carefully and sufficiently investigating applicable laws and regulations that regulate the inclusion or use of controlled substances, including without limitation, the EU RoHS Directive, and using Renesas Electronics products in compliance with all these applicable laws and regulations. Renesas Electronics disclaims any and all liability for damages or losses occurring as a result of your noncompliance with applicable laws and regulations.
  9. Renesas Electronics products and technologies shall not be used for or incorporated into any products or systems whose manufacture, use, or sale is prohibited under any applicable domestic or foreign laws or regulations. You shall comply with any applicable export control laws and regulations promulgated and administered by the governments of any countries asserting jurisdiction over the parties or transactions.
  10. It is the responsibility of the buyer or distributor of Renesas Electronics products, or any other party who distributes, disposes of, or otherwise sells or transfers the product to a third party, to notify such third party in advance of the contents and conditions set forth in this document.
  11. This document shall not be reprinted, reproduced or duplicated in any form, in whole or in part, without prior written consent of Renesas Electronics.
  12. Please contact a Renesas Electronics sales office if you have any questions regarding the information contained in this document or Renesas Electronics products.
- (Note 1) "Renesas Electronics" as used in this document means Renesas Electronics Corporation and also includes its directly or indirectly controlled subsidiaries.  
(Note 2) "Renesas Electronics product(s)" means any product developed or manufactured by or for Renesas Electronics.

(Rev.4.0-1 November 2017)



### SALES OFFICES

Renesas Electronics Corporation

<http://www.renesas.com>

Refer to "<http://www.renesas.com/>" for the latest and detailed information.

#### Renesas Electronics Corporation

TOYOSU FORESIA, 3-2-24 Toyosu, Koto-ku, Tokyo 135-0061, Japan

#### Renesas Electronics America Inc. Milpitas Campus

1001 Murphy Ranch Road, Milpitas, CA 95035, U.S.A.

Tel: +1-408-432-8888, Fax: +1-408-434-5351

#### Renesas Electronics America Inc. San Jose Campus

6024 Silver Creek Valley Road, San Jose, CA 95138, USA

Tel: +1-408-284-8200, Fax: +1-408-284-2775

#### Renesas Electronics Canada Limited

9251 Yonge Street, Suite 8309 Richmond Hill, Ontario Canada L4C 9T3

Tel: +1-905-237-2004

#### Renesas Electronics Europe GmbH

Arcadiastrasse 10, 40472 Düsseldorf, Germany

Tel: +49-211-6503-0, Fax: +49-211-6503-1327

#### Renesas Electronics (China) Co., Ltd.

Room 101-T01, Floor 1, Building 7, Yard No. 7, 8th Street, Shangdi, Haidian District, Beijing 100085, China

Tel: +86-10-8235-1155, Fax: +86-10-8235-7679

#### Renesas Electronics (Shanghai) Co., Ltd.

Unit 301, Tower A, Central Towers, 555 Langao Road, Putuo District, Shanghai 200333, China

Tel: +86-21-2226-0888, Fax: +86-21-2226-0999

#### Renesas Electronics Hong Kong Limited

Unit 1601-1611, 16/F., Tower 2, Grand Century Place, 193 Prince Edward Road West, Mongkok, Kowloon, Hong Kong

Tel: +852-2265-6688, Fax: +852 2886-9022

#### Renesas Electronics Taiwan Co., Ltd.

13F, No. 363, Fu Shing North Road, Taipei 10543, Taiwan

Tel: +886-2-8175-9600, Fax: +886 2-8175-9670

#### Renesas Electronics Singapore Pte. Ltd.

80 Bendemeer Road, #06-02 Singapore 339949

Tel: +65-6213-0200, Fax: +65-6213-0300

#### Renesas Electronics Malaysia Sdn.Bhd.

Unit No 3A-1 Level 3A Tower 8 UOA Business Park, No 1 Jalan Pengerutcara U1/51A, Seksyen U1, 40150 Shah Alam, Selangor, Malaysia

Tel: +60-3-5022-1288, Fax: +60-3-5022-1290

#### Renesas Electronics India Pvt. Ltd.

No.77C, 100 Feet Road, HAL 2nd Stage, Indiranagar, Bangalore 560 038, India

Tel: +91-80-67208700

#### Renesas Electronics Korea Co., Ltd.

17F, KAMCO Yangjae Tower, 262, Gangnam-daero, Gangnam-gu, Seoul, 06265 Korea

Tel: +82-2-558-3737, Fax: +82-2-558-5338