

RL78/L12

R01DS0157EJ0212

RENESAS MCU

Rev.2.12

Dec 22, 2020

True low-power platform (62.5 $\mu\text{A}/\text{MHz}$, and 0.64 μA for operation with only RTC and LVD) for the LCD-based applications, with the on-chip LCD controller and driver, 8- to 32-Kbyte code flash memory, 1.6-V to 5.5-V operation, and 31 DMIPS at 24 MHz

1. OUTLINE

1.1 Features

Ultra-Low Power Technology

- 1.6 V to 5.5 V operation from a single supply
- Stop (RAM retained): 0.23 μA , (LVD enabled): 0.31 μA
- Halt (RTC + LVD): 0.64 μA
- Supports snooze
- Operating: 62.5 $\mu\text{A}/\text{MHz}$
- LCD operating current (Capacitor split method): 0.12 μA
- LCD operating current (Internal voltage boost method): 0.63 μA ($V_{\text{DD}} = 3.0 \text{ V}$)

16-bit RL78 CPU Core

- Delivers 31 DMIPS at maximum operating frequency of 24 MHz
- Instruction Execution: 86% of instructions can be executed in 1 to 2 clock cycles
- CISC Architecture (Harvard) with 3-stage pipeline
- Multiply Signed & Unsigned: 16 x 16 to 32-bit result in 1 clock cycle
- MAC: 16 x 16 to 32-bit result in 2 clock cycles
- 16-bit barrel shifter for shift & rotate in 1 clock cycle
- 1-wire on-chip debug function

Code Flash Memory

- Density: 8 KB to 32 KB
- Block size: 1 KB
- On-chip single voltage flash memory with protection from block erase/writing
- Self-programming with flash shield window function

Data Flash Memory

- Data flash with background operation
- Data flash size: 2 KB size
- Erase cycles: 1 Million (typ.)
- Erase/programming voltage: 1.8 V to 5.5 V

RAM

- 1 KB and 1.5 KB size options
- Supports operands or instructions
- Back-up retention in all modes

High-speed On-chip Oscillator

- 24 MHz with $\pm 1\%$ accuracy over voltage (1.8 V to 5.5 V) and temperature (-20°C to 85°C)
- Pre-configured settings: 24 MHz, 16 MHz, 12 MHz, 8 MHz, 6 MHz, 4 MHz, 3 MHz, 2 MHz & 1 MHz

Reset and Supply Management

- Power-on reset (POR) monitor/generator
- Low voltage detection (LVD) with 14 setting options (Interrupt and/or reset function)

LCD Controller/Driver

- Up to 35 seg x 8 com or 39 seg x 4 com
- Supports capacitor split method, internal voltage boost method and resistance division method
- Supports waveform types A and B
- Supports LCD contrast adjustment (16 steps)
- Supports LCD blinking

Direct Memory Access (DMA) Controller

- Up to 2 fully programmable channels
- Transfer unit: 8- or 16-bit

Multiple Communication Interfaces

- Up to 1 x I²C multi-master
- Up to 2 x CSI/SPI (7-, 8-bit)
- Up to 1 x UART (7-, 8-, 9-bit)
- Up to 1 x LIN

Extended-Function Timers

- Multi-function 16-bit timers: Up to 8 channels
- Real-time clock (RTC): 1 channel (full calendar and alarm function with watch correction function)
- Interval Timer: 12-bit, 1 channel
- 15 kHz watchdog timer: 1 channel (window function)

Rich Analog

- ADC: Up to 10 channels, 10-bit resolution, 2.1 μs conversion time
- Supports 1.6 V
- Internal reference voltage (1.45 V)
- On-chip temperature sensor

Safety Features (IEC or UL 60730 compliance)

- Flash memory CRC calculation
- RAM parity error check
- RAM write protection
- SFR write protection
- Illegal memory access detection
- Clock frequency detection
- ADC self-test

General Purpose I/O

- 5V tolerant, high-current (up to 20 mA per pin)
- Open-Drain, Internal Pull-up support

Operating Ambient Temperature

- T_A: -40°C to $+85^\circ\text{C}$ (A: Consumer applications)
- T_A: -40°C to $+105^\circ\text{C}$ (G: Industrial applications)

Package Type and Pin Count

From 7mm x 7mm to 12mm x 12mm
QFP: 32, 44, 48, 52, 64

○ ROM, RAM capacities

Flash ROM	Data flash	RAM	RL78/L12				
			32 pins	44 pins	48 pins	52 pins	64 pins
32 KB	2 KB	1.5 KB ^{Note}	R5F10RBC	R5F10RFC	R5F10RGC	R5F10RJC	R5F10RLC
16 KB	2 KB	1 KB ^{Note}	R5F10RBA	R5F10RFA	R5F10RGA	R5F10RJA	R5F10RLA
8KB	2 KB	1 KB ^{Note}	R5F10RB8	R5F10RF8	R5F10RG8	R5F10RJ8	–

Note In the case of the 1 KB, and 1.5 KB, this is 630 bytes when the self-programming function and data flash function is used.

Remark The functions mounted depend on the product. See **1.6 Outline of Functions**.

1.2 List of Part Numbers

<R>

Figure 1-1. Part Number, Memory Size, and Package of RL78/L12

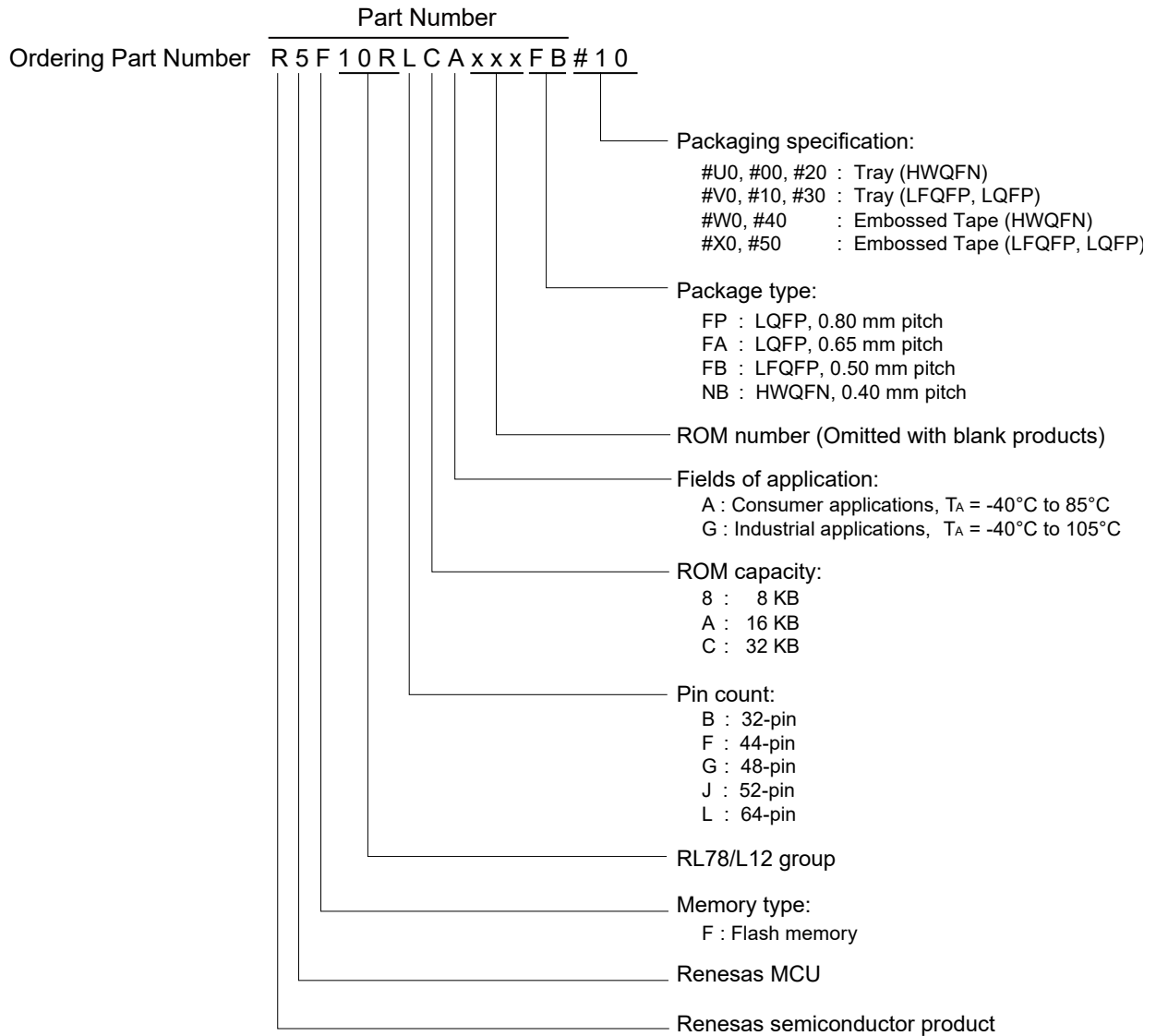

<R>

Table 1-1. List of Ordering Part Numbers

Pin count	Package	Data Flash	Fields of Application Note	Ordering Part Number		RENESAS Code
				Part Number	Packaging specification	
32 pins	32-pin plastic LQFP (7 × 7 mm, 0.8 mm pitch)	Mounted	A	R5F10RB8AFP, R5F10RBAAFP, R5F10RBCAFP	#V0, #X0 #10, #30, #50	PLQP0032GB-A
			G	R5F10RB8GFP, R5F10RBAGFP, R5F10RBCGFP		
44 pins	44-pin plastic LQFP (10 × 10 mm, 0.8 mm pitch)	Mounted	A	R5F10RF8AFP, R5F10RFAAFP, R5F10RFCAFP	#V0, #X0 #10, #30, #50	PLQP0044GC-A PLQP0044GC-A/ PLQP0044GC-D
			G	R5F10RF8GFP, R5F10RFAGFP, R5F10RFCGFP	#V0, #X0 #10, #30, #50	PLQP0044GC-A PLQP0044GC-A/ PLQP0044GC-D
48 pins	48-pin plastic LFQFP (7 × 7 mm, 0.5 mm pitch)	Mounted	A	R5F10RG8AFB, R5F10RGAAFB, R5F10RGCAFB	#V0, #X0 #10, #30, #50	PLQP0048KF-A PLQP0048KB-B
			G	R5F10RG8GFB, R5F10RGAGFB, R5F10RGCGB	#V0, #X0 #10, #30, #50	PLQP0048KF-A PLQP0048KB-B
52 pins	52-pin plastic LQFP (10 × 10 mm, 0.65 mm pitch)	Mounted	A	R5F10RJ8AFA, R5F10RJAAFA, R5F10RJCAFA	#V0, #X0 #10, #30, #50	PLQP0052JA-A
			G	R5F10RJ8GFA, R5F10RJAGFA, R5F10RJCGFA		
64 pins	64-pin plastic HWQFN (8 × 8 mm, 0.4 mm pitch)	Mounted	A	R5F10RLAANB, R5F10RLCANB	#U0, #W0	PWQN0064LA-A
					#00, #20, #40	PWQN0064LB-A
			G	R5F10RLAGNB, R5F10RLCGNB	#U0, #W0 #00, #20, #40	PWQN0064LA-A PWQN0064LB-A
	64-pin plastic LFQFP (10 × 10 mm, 0.5 mm pitch)	Mounted	A	R5F10RLAAFB, R5F10RLCAFB	#V0, #X0 #10, #30, #50	PLQP0064KF-A PLQP0064KB-C
			G	R5F10RLAGFB, R5F10RLCGFB	#V0, #X0 #10, #30, #50	PLQP0064KF-A PLQP0064KB-C
	64-pin plastic LQFP (12 × 12 mm, 0.65 mm pitch)	Mounted	A	R5F10RLAAFA, R5F10RLCAFA	#V0, #X0	PLQP0064JA-A
G			R5F10RLAGFA, R5F10RLCGFA	#10, #30, #50		

Note For the fields of application, refer to **Figure 1-1 Part Number, Memory Size, and Package of RL78/L12**.

Caution The ordering part numbers represent the numbers at the time of publication. For the latest ordering part numbers, refer to the target product page of the Renesas Electronics website.

1.3 Pin Configuration (Top View)

1.3.1 32-pin products

- 32-pin plastic LQFP (7 × 7 mm, 0.8 mm pitch)

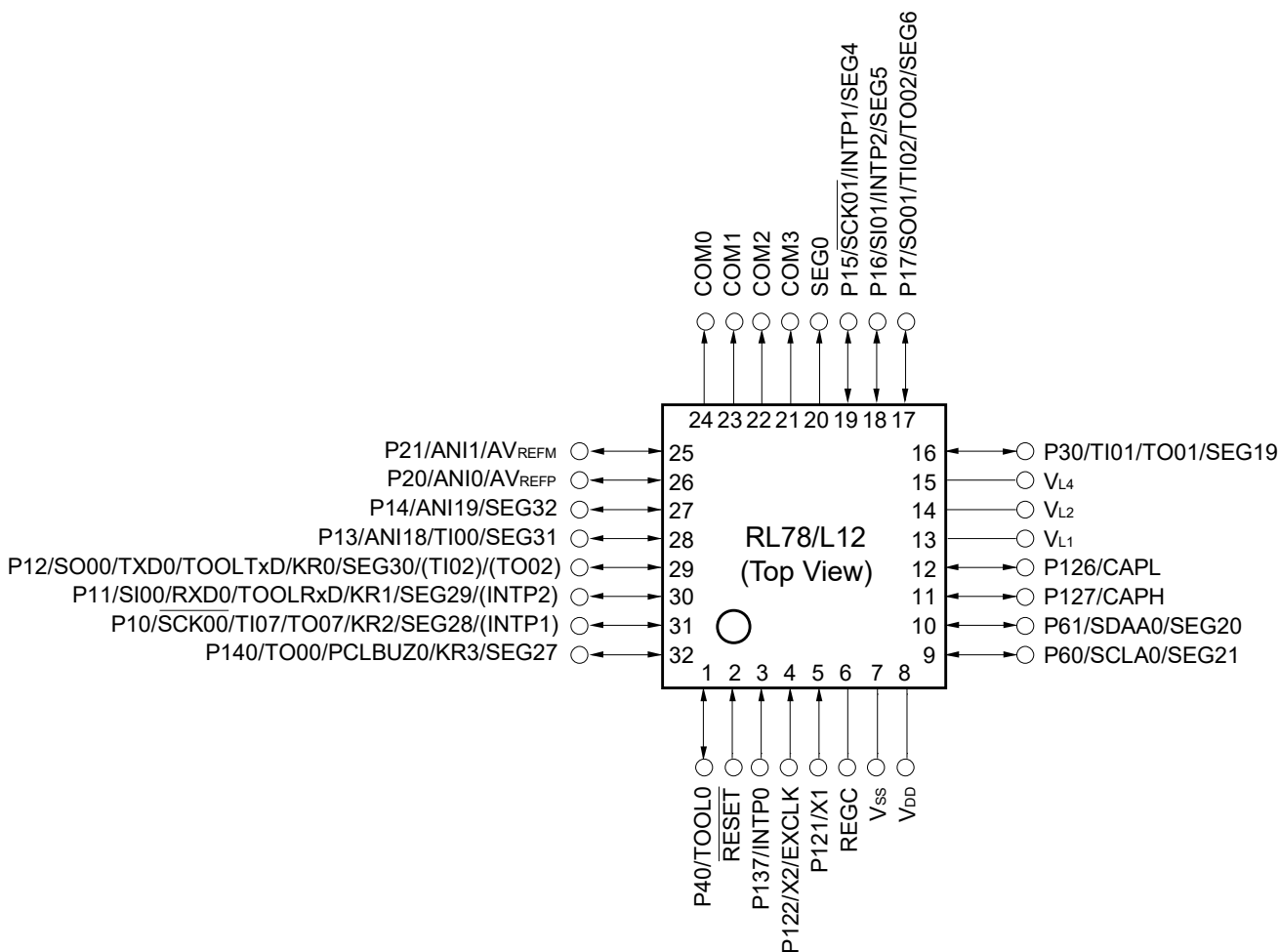

Caution Connect the REGC pin to V_{SS} via a capacitor (0.47 to 1 μF).

- Remarks**
1. For pin identification, see 1.4 Pin Identification.
 2. Functions in parentheses in the above figure can be assigned via settings in the peripheral I/O redirection register (PIOR).

1.3.2 44-pin products

- 44-pin plastic LQFP (10 × 10 mm, 0.8 mm pitch)

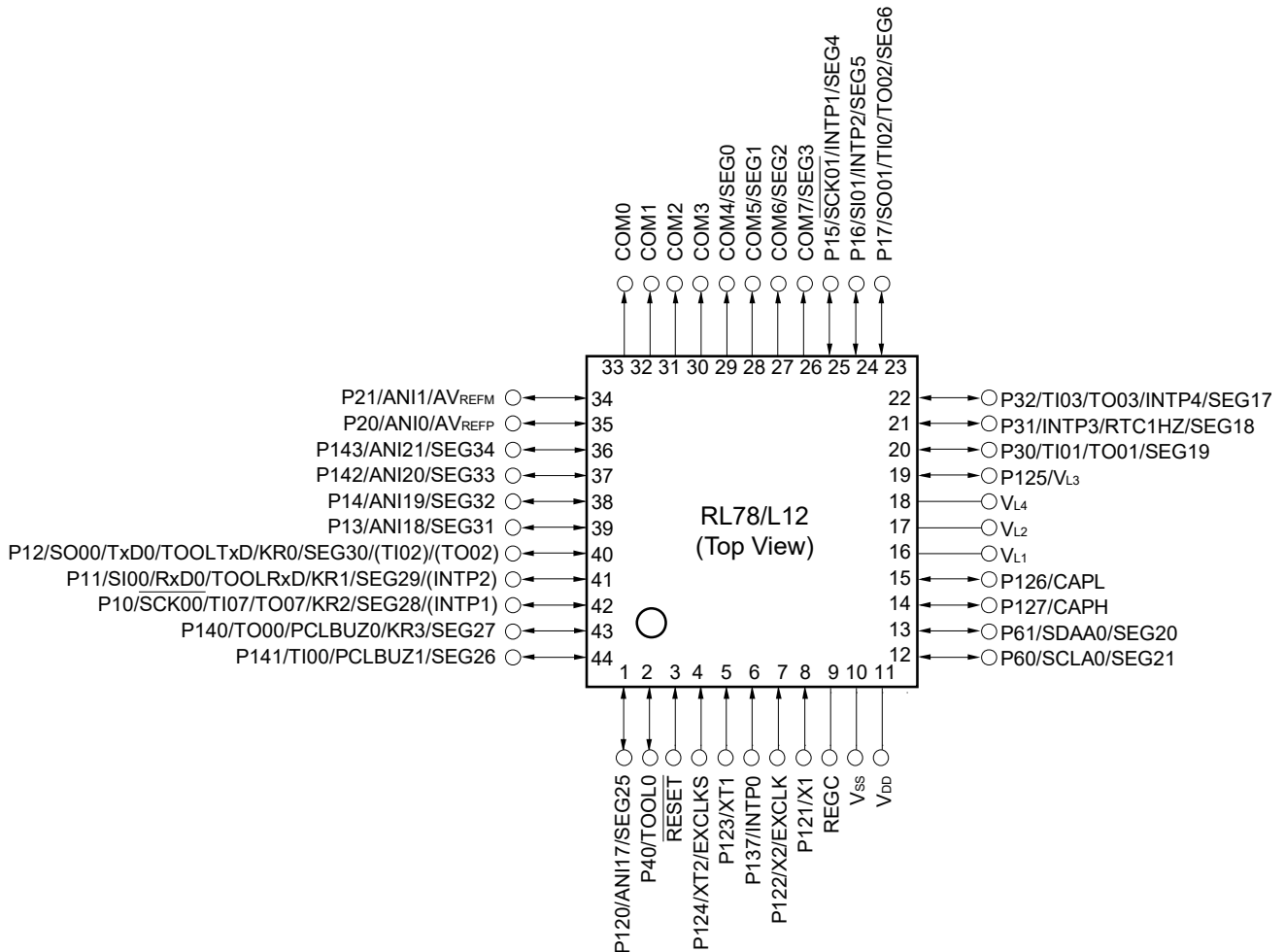

Caution Connect the REGC pin to V_{SS} via a capacitor (0.47 to 1 μF).

Remarks 1. For pin identification, see 1.4 Pin Identification.

2. Functions in parentheses in the above figure can be assigned via settings in the peripheral I/O redirection register (PIOR).

1.3.3 48-pin products

- 48-pin plastic LQFP (7 × 7 mm, 0.5 mm pitch)

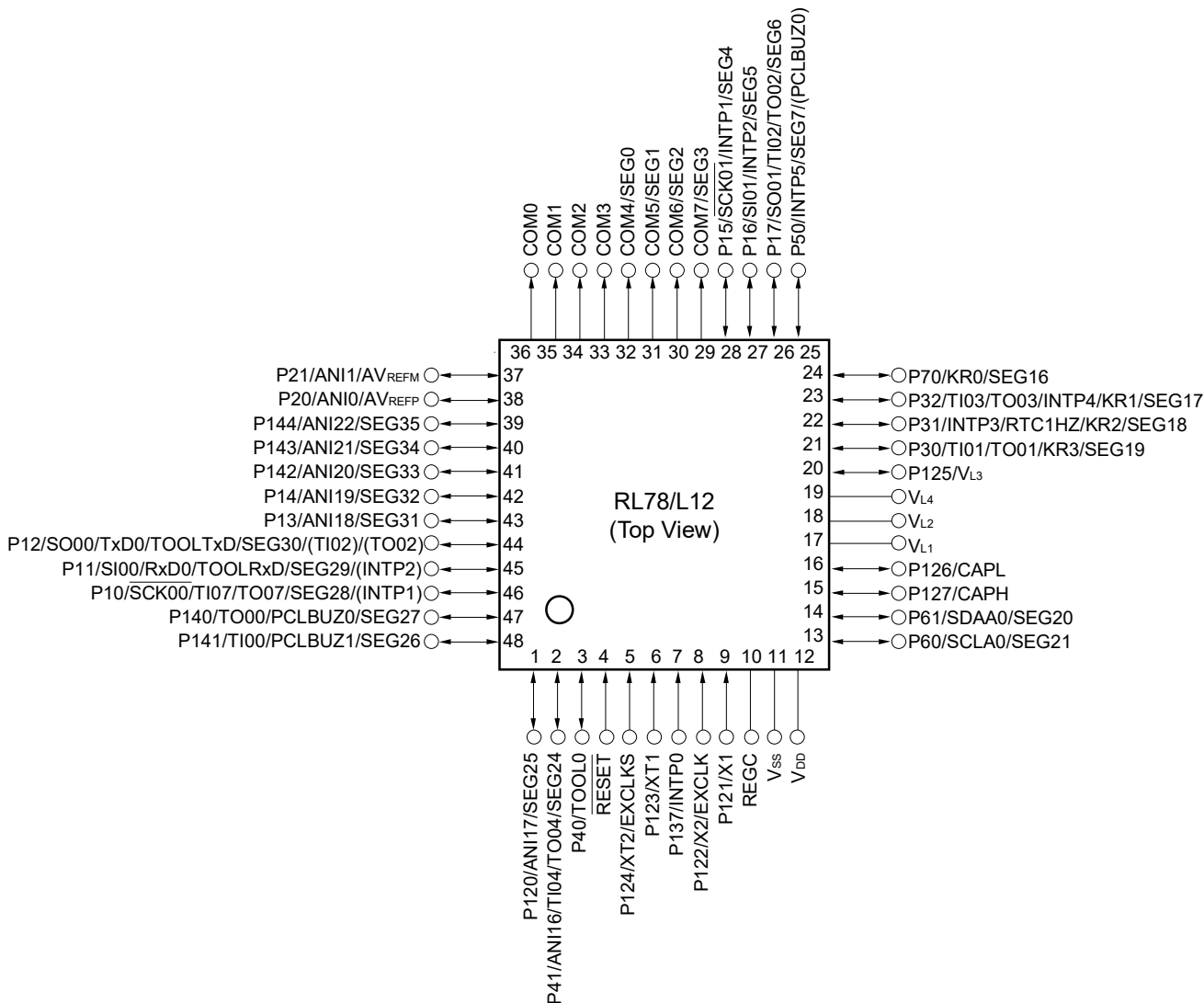

Caution Connect the REGC pin to V_{SS} via a capacitor (0.47 to 1 μF).

- Remarks**
1. For pin identification, see 1.4 Pin Identification.
 2. Functions in parentheses in the above figure can be assigned via settings in the peripheral I/O redirection register (PIOR).

1.3.4 52-pin products

- 52-pin plastic LQFP (10 × 10 mm, 0.65 mm pitch)

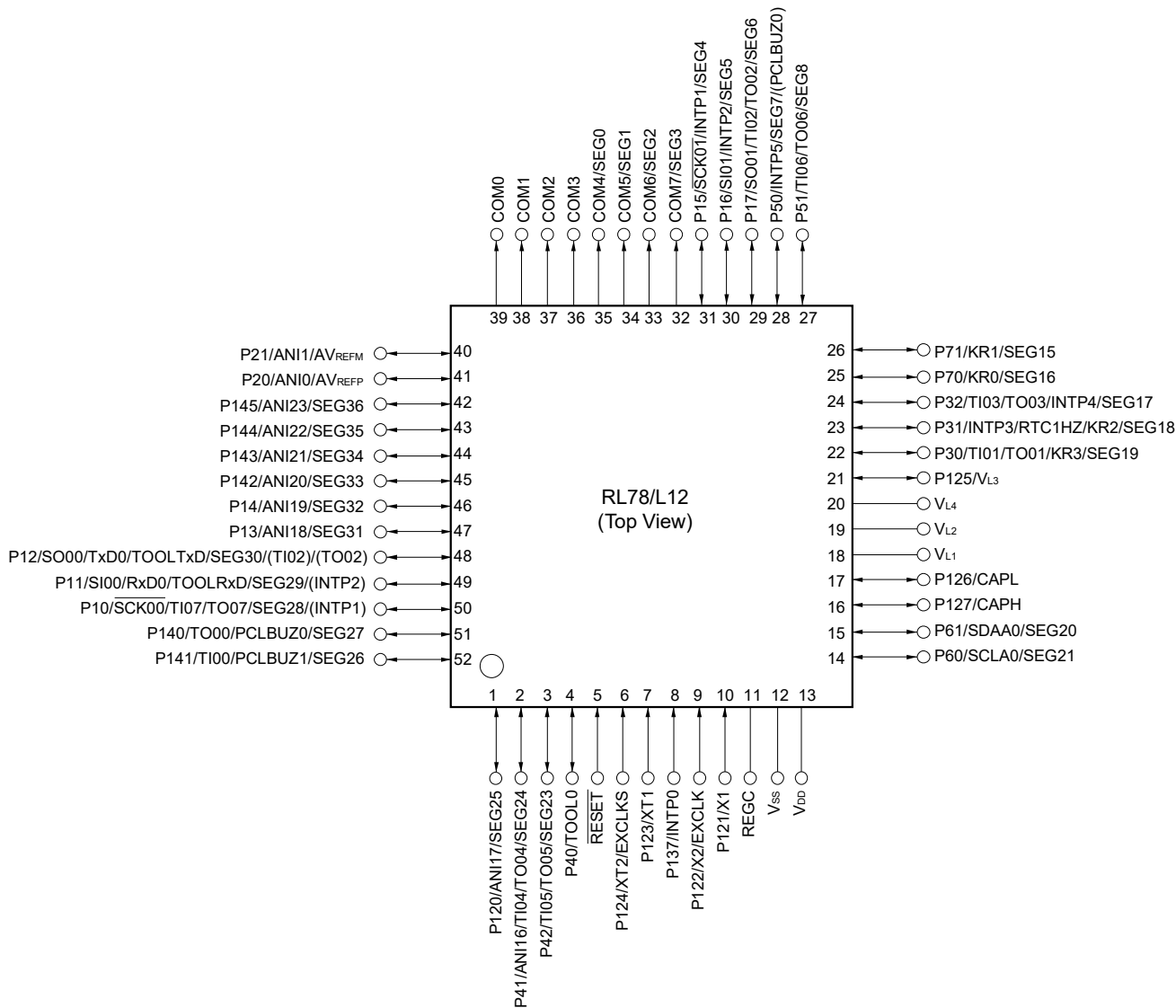

Caution Connect the REGC pin to V_{SS} via a capacitor (0.47 to 1 μF).

Remarks 1. For pin identification, see 1.4 Pin Identification.

2. Functions in parentheses in the above figure can be assigned via settings in the peripheral I/O redirection register (PIOR).

1.3.5 64-pin products

- 64-pin plastic HWQFN (8 × 8 mm, 0.4 mm pitch)

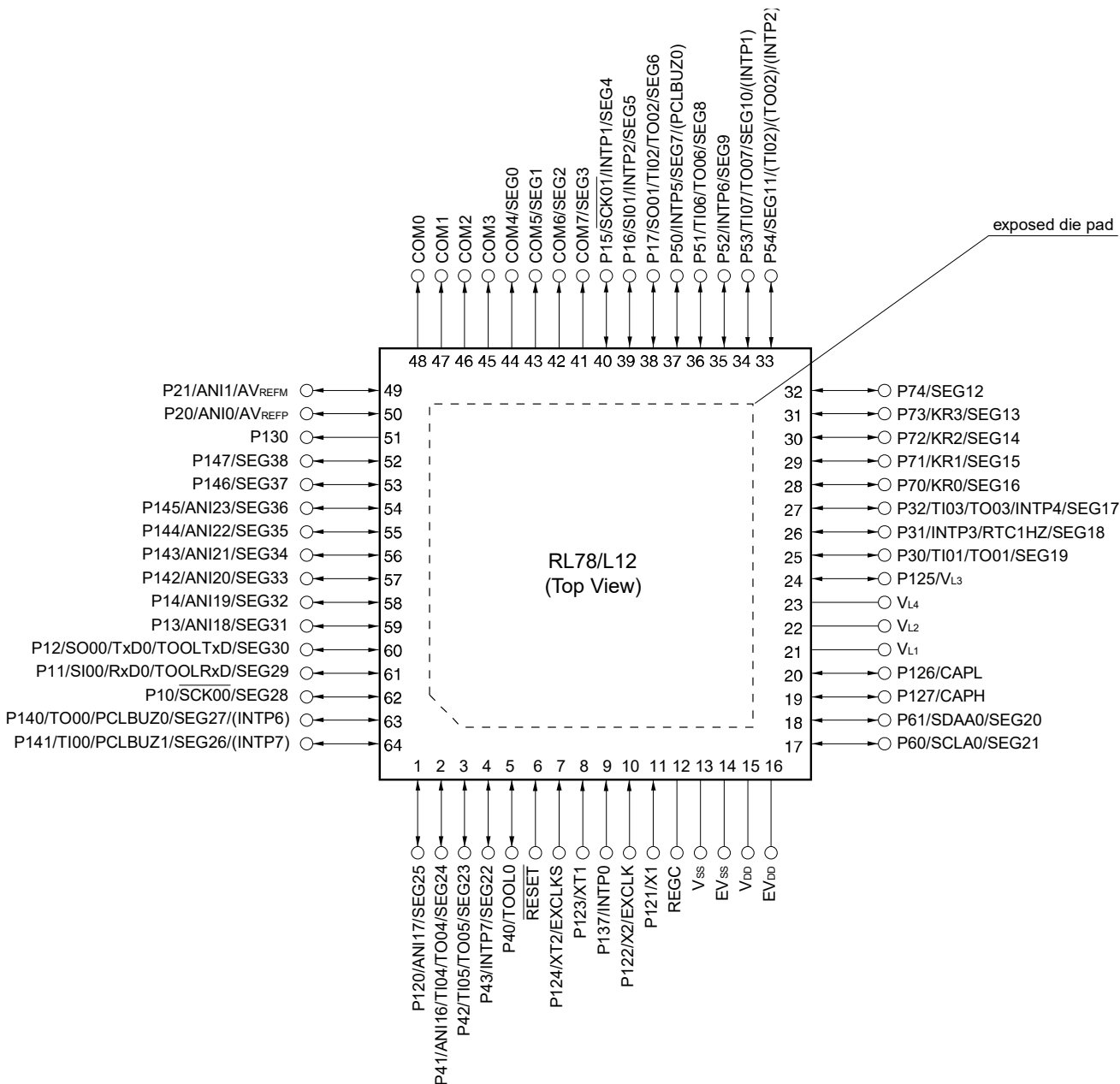

- Cautions**
1. Make EV_{SS} pin the same potential as V_{SS} pin.
 2. Make V_{DD} pin the same potential as EV_{DD} pin.
 3. Connect the REGC pin to V_{SS} via a capacitor (0.47 to 1 μF).

- Remarks**
1. For pin identification, see 1.4 Pin Identification.
 2. When using the microcontroller for an application where the noise generated inside the microcontroller must be reduced, it is recommended to supply separate powers to the V_{DD} and EV_{DD} pins and connect the V_{SS} and EV_{SS} pins to separate ground lines.
 3. Functions in parentheses in the above figure can be assigned via settings in the peripheral I/O redirection register (PIOR).

- 64-pin plastic LQFP (10 × 10 mm, 0.5 mm pitch)
- 64-pin plastic LQFP (12 × 12 mm, 0.65 mm pitch)

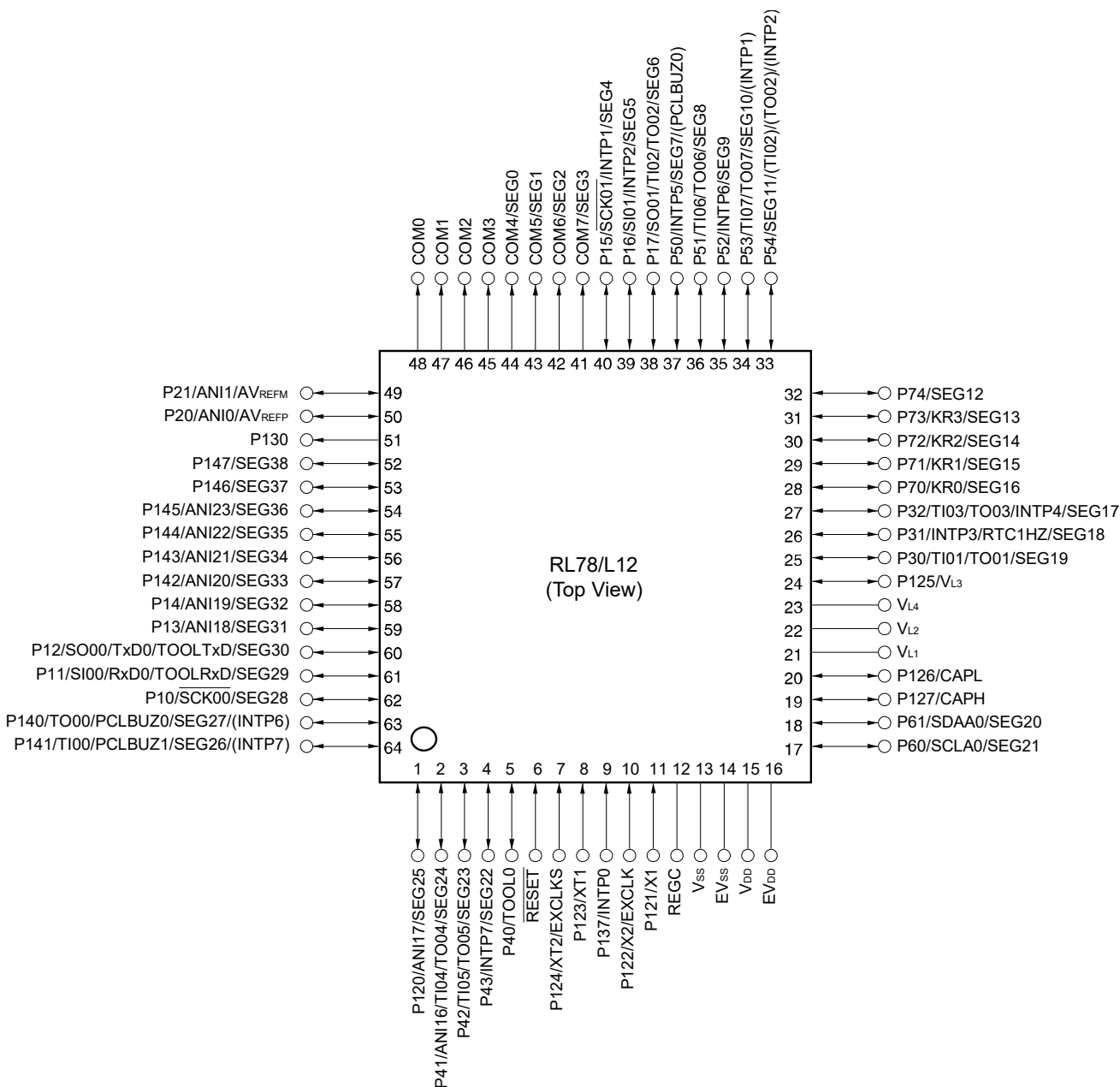

- Cautions**
1. Make EV_{SS} pin the same potential as V_{SS} pin.
 2. Make V_{DD} pin the same potential as EV_{DD} pin.
 3. Connect the REGC pin to V_{SS} via a capacitor (0.47 to 1 μF).

- Remarks**
1. For pin identification, see 1.4 Pin Identification.
 2. When using the microcontroller for an application where the noise generated inside the microcontroller must be reduced, it is recommended to supply separate powers to the V_{DD} and EV_{DD} pins and connect the V_{SS} and EV_{SS} pins to separate ground lines.
 3. Functions in parentheses in the above figure can be assigned via settings in the peripheral I/O redirection register (PIOR).

1.4 Pin Identification

ANI0, ANI1,		P130, P137:	Port 13
ANI16 to ANI23:	Analog Input	P140 to P147:	Port 14
AVREFM:	Analog Reference Voltage Minus	PCLBUZ0, PCLBUZ1:	Programmable Clock Output/Buzzer Output
AVREFP:	Analog Reference Voltage Plus	REGC:	Regulator Capacitance
CAPH, CAPL:	Capacitor for LCD	<u>RESET</u> :	Reset
COM0 to COM7,		RTC1HZ:	Real-time Clock Correction Clock (1 Hz) Output
EVDD:	Power Supply for Port	RxD0:	Receive Data
EVSS:	Ground for Port	<u>SCK00</u> , <u>SCK01</u> ,	
EXCLK:	External Clock Input (Main System Clock)	SCLA0:	Serial Clock Input/Output
		SDAA0:	Serial Data Input/Output
EXCLKS:	External Clock Input (Subsystem Clock)	SEG0 to SEG38:	LCD Segment Output
		SI00, SI01:	Serial Data Input
INTP0 to INTP7:	Interrupt Request From Peripheral	SO00, SO01:	Serial Data Output
		TI00 to TI07:	Timer Input
KR0 to KR3:	Key Return	TO00 to TO07:	Timer Output
P10 to P17:	Port 1	TOOL0:	Data Input/Output for Tool
P20, P21:	Port 2	TOOLRxD, TOOLTxD:	Data Input/Output for External Device
P30 to P32:	Port 3	TxD0:	Transmit Data
P40 to P43:	Port 4	V _{DD} :	Power Supply
P50 to P54:	Port 5	V _{L1} to V _{L4} :	LCD Power Supply
P60, P61:	Port 6	V _{SS} :	Ground
P70 to P74:	Port 7	X1, X2:	Crystal Oscillator (Main System Clock)
P120 to P127:	Port 12	XT1, XT2:	Crystal Oscillator (Subsystem Clock)

1.5 Block Diagram

1.5.1 32-pin products

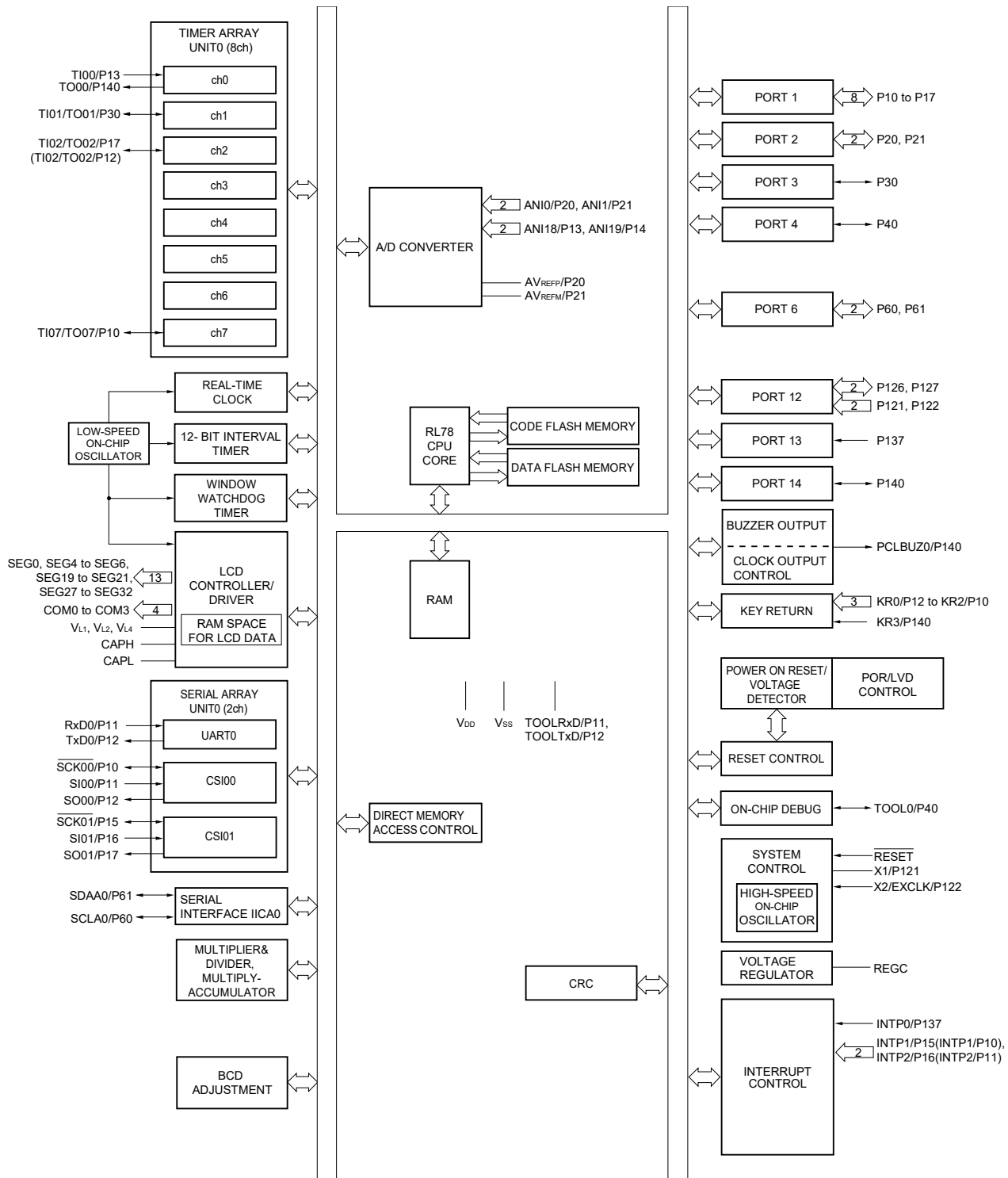

Remark Functions in parentheses in the above figure can be assigned via settings in the peripheral I/O redirection register (PIOR).

1.5.2 44-pin products

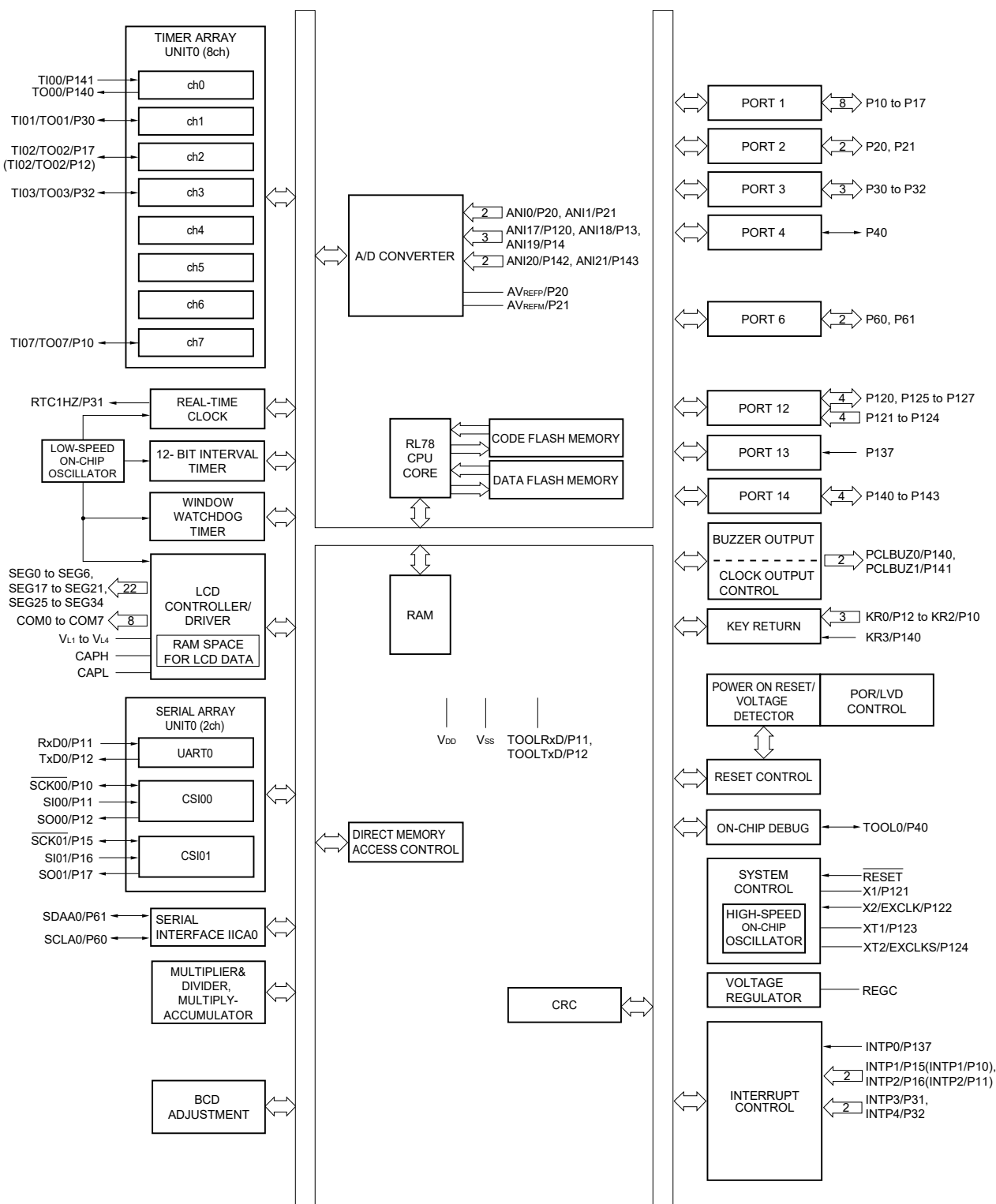

Remark Functions in parentheses in the above figure can be assigned via settings in the peripheral I/O redirection register (PIOR).

1.5.3 48-pin products

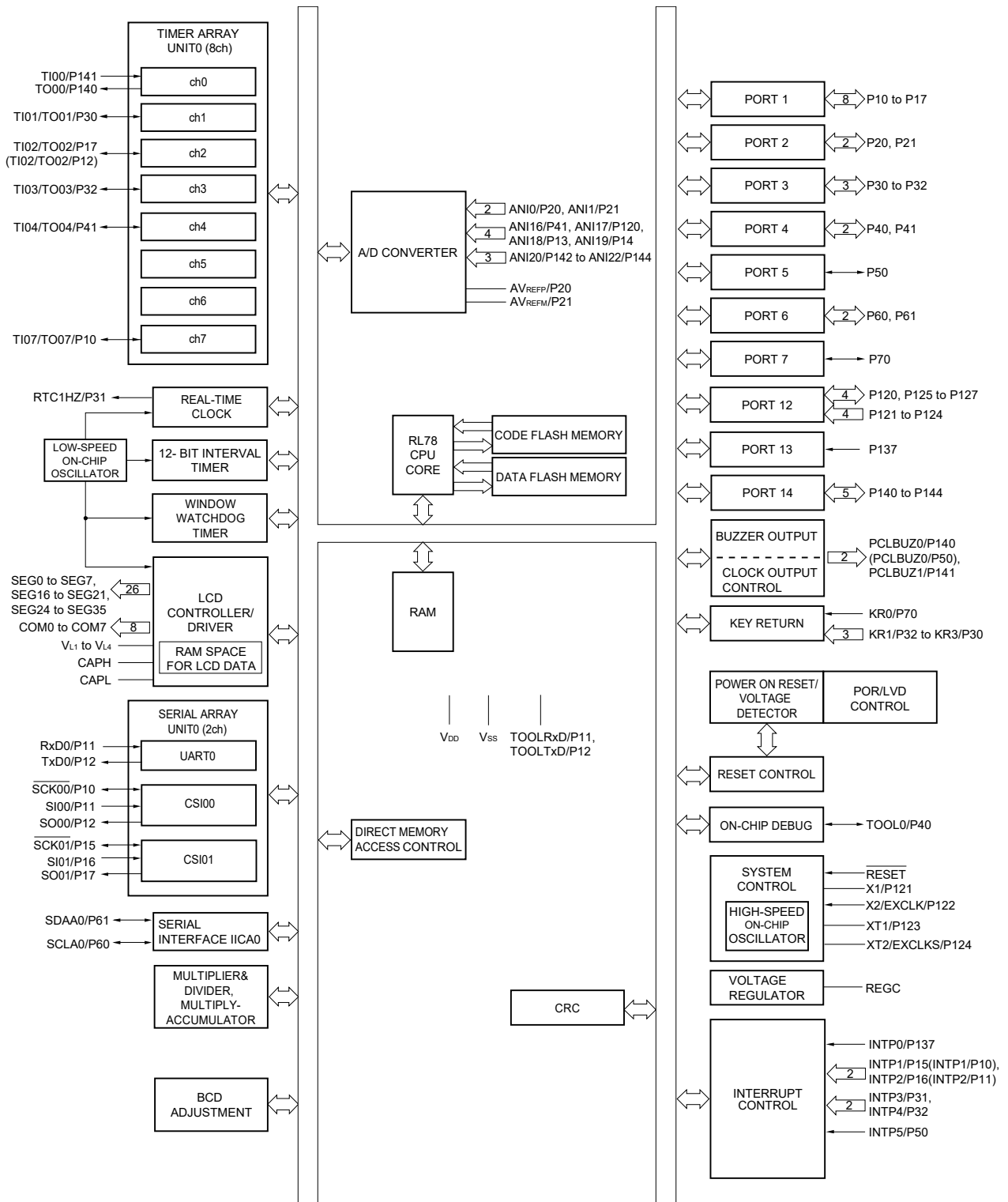

Remark Functions in parentheses in the above figure can be assigned via settings in the peripheral I/O redirection register (PIOR).

1.5.4 52-pin products

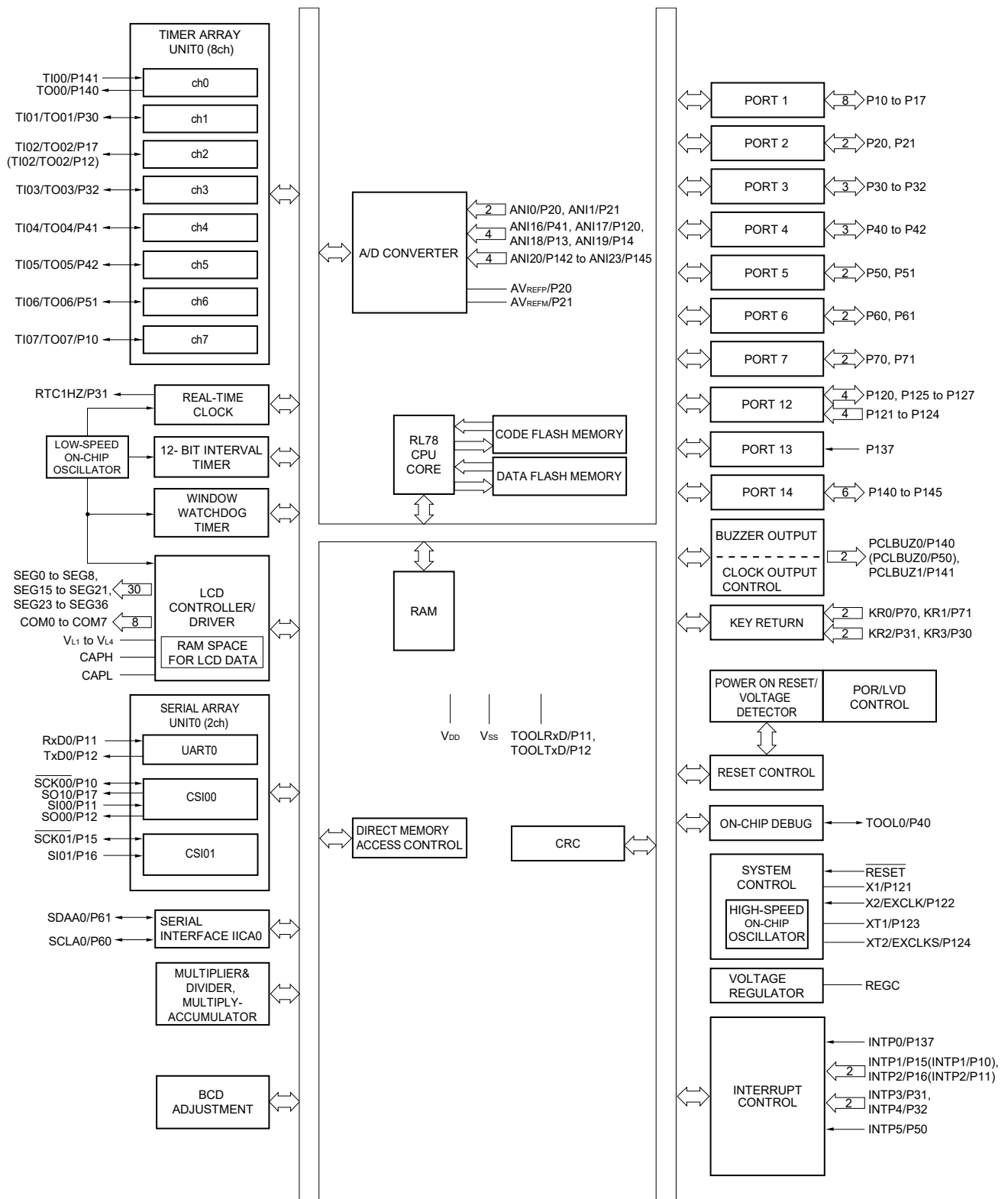

Remark Functions in parentheses in the above figure can be assigned via settings in the peripheral I/O redirection register (PIOR).

1.5.5 64-pin products

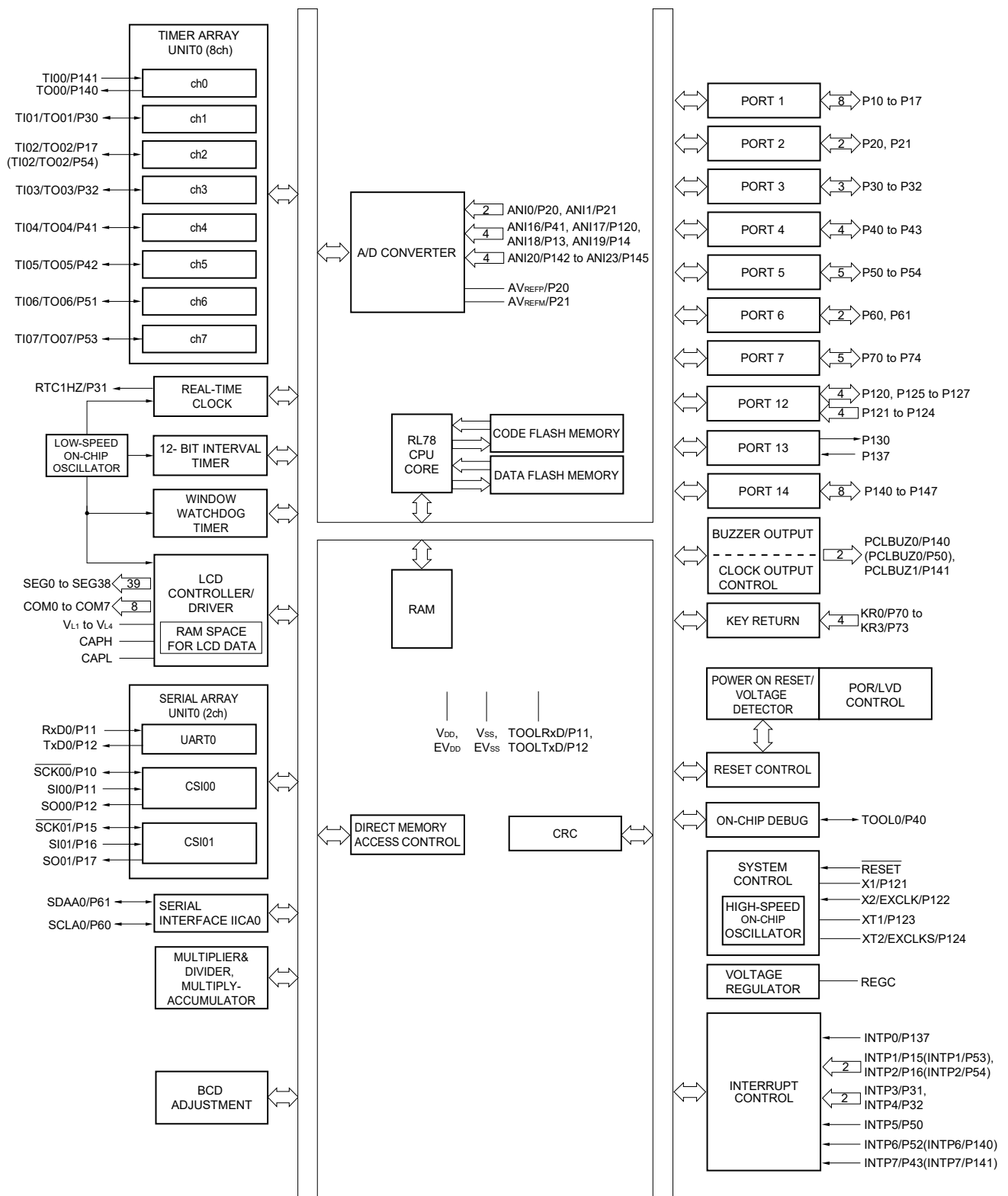

Remark Functions in parentheses in the above figure can be assigned via settings in the peripheral I/O redirection register (PIOR).

1.6 Outline of Functions

Caution This outline describes the functions at the time when Peripheral I/O redirection register (PIOR) is set to 00H.

Item		(1/2)				
		32-pin R5F10RBx	44-pin R5F10RFx	48-pin R5F10RGx	52-pin R5F10RJx	64-pin R5F10RLx
Code flash memory (KB)		8 to 32	8 to 32	8 to 32	8 to 32	16, 32
Data flash memory (KB)		2	2	2	2	2
RAM (KB)		1, 1.5 ^{Note 1}	1, 1.5 ^{Note 1}	1, 1.5 ^{Note 1}	1, 1.5 ^{Note 1}	1, 1.5 ^{Note 1}
Memory space		1 MB				
Main system clock	High-speed system clock	X1 (crystal/ceramic) oscillation, external main system clock input (EXCLK) HS (high-speed main) operation: 1 to 20 MHz ($V_{DD} = 2.7$ to 5.5 V), HS (high-speed main) operation: 1 to 16 MHz ($V_{DD} = 2.4$ to 5.5 V), LS (low-speed main) operation: 1 to 8 MHz ($V_{DD} = 1.8$ to 5.5 V), LV (low-voltage main) operation: 1 to 4 MHz ($V_{DD} = 1.6$ to 5.5 V)				
	High-speed on-chip oscillator clock	HS (high-speed main) operation: 1 to 24 MHz ($V_{DD} = 2.7$ to 5.5 V), HS (high-speed main) operation: 1 to 16 MHz ($V_{DD} = 2.4$ to 5.5 V), LS (low-speed main) operation: 1 to 8 MHz ($V_{DD} = 1.8$ to 5.5 V), LV (low-voltage main) operation: 1 to 4 MHz ($V_{DD} = 1.6$ to 5.5 V)				
Subsystem clock		–	XT1 (crystal) oscillation, external subsystem clock input (EXCLKS) 32.768 kHz (TYP.): $V_{DD} = 1.6$ to 5.5 V			
Low-speed on-chip oscillator clock		Internal oscillation 15 kHz (TYP.): $V_{DD} = 1.6$ to 5.5 V				
General-purpose register		8 bits × 32 registers (8 bits × 8 registers × 4 banks)				
Minimum instruction execution time		0.04167 μ s (High-speed on-chip oscillator clock: $f_{IH} = 24$ MHz operation)				
		0.05 μ s (High-speed system clock: $f_{MX} = 20$ MHz operation)				
		30.5 μ s (Subsystem clock: $f_{SUB} = 32.768$ kHz operation)				
Instruction set		<ul style="list-style-type: none"> • Data transfer (8/16 bits) • Adder and subtractor/logical operation (8/16 bits) • Multiplication (8 bits × 8 bits) • Rotate, barrel shift, and bit manipulation (Set, reset, test, and Boolean operation), etc. 				
Total number of I/O port pins and pins dedicated to drive an LCD		28	40	44	48	58
I/O port	Total	20	29	33	37	47
	CMOS I/O	15	22	26	30	39
	CMOS input	3	5	5	5	5
	CMOS output	–	–	–	–	1
	N-ch open-drain I/O (E_{VDD} tolerance)	2	2	2	2	2
Pins dedicated to drive an LCD		8	11	11	11	11
LCD controller/driver		Internal voltage boosting method, capacitor split method, and external resistance division method are switchable.				
Segment signal output		13	22 (18) ^{Note 2}	26 (22) ^{Note 2}	30 (26) ^{Note 2}	39 (35) ^{Note 2}
Common signal output		4	4 (8) ^{Note 2}			

Notes 1. In the case of the 1 KB, and 1.5 KB, this is 630 bytes when the self-programming function and data flash function is used.

2. The values in parentheses are the number of signal outputs when 8 com is used.

(2/2)

Item		32-pin	44-pin	48-pin	52-pin	64-pin
		R5F10RBx	R5F10RFx	R5F10RGx	R5F10RJx	R5F10RLx
Timer	16-bit timer	8 channels	8 channels (with 1 channel remote control output function)			
	Watchdog timer	1 channel				
	Real-time clock (RTC)	1 channel				
	12-bit interval timer (IT)	1 channel				
	Timer output	4 channels (PWM outputs: 3 ^{Note 1})	5 channels (PWM outputs: 4 ^{Note 1})	6 channels (PWM outputs: 5 ^{Note 1})	8 channels (PWM outputs: 7 ^{Note 1})	
	RTC output	–	1 • 1 Hz (subsystem clock: $f_{SUB} = 32.768$ kHz)			
Clock output/buzzer output		1	2 • 2.44 kHz, 4.88 kHz, 9.76 kHz, 1.25 MHz, 2.5 MHz, 5 MHz, 10 MHz (Main system clock: $f_{MAIN} = 20$ MHz operation) • 256 Hz, 512 Hz, 1.024 kHz, 2.048 kHz, 4.096 kHz, 8.192 kHz, 16.384 kHz, 32.768 kHz (Subsystem clock: $f_{SUB} = 32.768$ kHz operation)			
8/10-bit resolution A/D converter		4 channels	7 channels	9 channels	10 channels	10 channels
Serial interface		• CSI: 2 channel/UART (LIN-bus supported): 1 channel				
	I ² C bus	1 channel	1 channel	1 channel	1 channel	1 channel
Multiplier and divider/multiply-accumulator		• 16 bits × 16 bits = 32 bits (Unsigned or signed) • 32 bits ÷ 32 bits = 32 bits (Unsigned) • 16 bits × 16 bits + 32 bits = 32 bits (Unsigned or signed)				
DMA controller		2 channels				
Vectored interrupt sources	Internal	23	23	23	23	23
	External	4	6	7	7	9
Key interrupt		4				
Reset		• Reset by \overline{RESET} pin • Internal reset by watchdog timer • Internal reset by power-on-reset • Internal reset by voltage detector • Internal reset by illegal instruction execution ^{Note 2} • Internal reset by RAM parity error • Internal reset by illegal-memory access				
Power-on-reset circuit		• Power-on-reset: 1.51 ±0.04 V • Power-down-reset: 1.50 ±0.04 V				
Voltage detector		• Rising edge : 1.67 V to 4.06 V (14 stages) • Falling edge : 1.63 V to 3.98 V (14 stages)				
On-chip debug function		Provided				
Power supply voltage		$V_{DD} = 1.6$ to 5.5 V				
Operating ambient temperature		$T_A = -40$ to +85 °C				

Notes 1. The number of PWM outputs varies depending on the setting of channels in use (the number of masters and slaves).

2. The illegal instruction is generated when instruction code FFH is executed.

Reset by the illegal instruction execution not issued by emulation with the in-circuit emulator or on-chip debug emulator.

2. ELECTRICAL SPECIFICATIONS (A, G: T_A = -40 to +85°C)

This chapter describes the electrical specifications for the products "A: Consumer applications (T_A = -40 to +85°C)" and "G: Industrial applications (with T_A = -40 to +85°C)".

- Cautions**
- 1. The RL78 microcontrollers have an on-chip debug function, which is provided for development and evaluation. Do not use the on-chip debug function in products designated for mass production, because the guaranteed number of rewritable times of the flash memory may be exceeded when this function is used, and product reliability therefore cannot be guaranteed. Renesas Electronics is not liable for problems occurring when the on-chip debug function is used.**
 - 2. With products not provided with an EV_{DD}, or EV_{SS} pin, replace EV_{DD} with V_{DD}, or replace EV_{SS} with V_{SS}.**

2.1 Absolute Maximum Ratings

Absolute Maximum Ratings (T_A = 25°C)

(1/3)

Parameter	Symbols	Conditions	Ratings	Unit
Supply voltage	V _{DD}	V _{DD} = EV _{DD}	-0.5 to +6.5	V
	EV _{DD}	V _{DD} = EV _{DD}	-0.5 to +6.5	V
	EV _{SS}		-0.5 to +0.3	V
REGC pin input voltage	V _{IREGC}	REGC	-0.3 to +2.8 and -0.3 to V _{DD} + 0.3 ^{Note 1}	V
Input voltage	V _{I1}	P10 to P17, P30 to P32, P40 to P43, P50 to P54, P70 to P74, P120, P125 to P127, P140 to P147	-0.3 to EV _{DD} + 0.3 and -0.3 to V _{DD} + 0.3 ^{Note 2}	V
	V _{I2}	P60, P61 (N-ch open-drain)	-0.3 to EV _{DD} + 0.3 and -0.3 to V _{DD} + 0.3 ^{Note 2}	V
	V _{I3}	P20, P21, P121 to P124, P137, EXCLK, EXCLKS, RESET	-0.3 to V _{DD} + 0.3 ^{Note 2}	V
Output voltage	V _{O1}	P10 to P17, P30 to P32, P40 to P43, P50 to P54, P60, P61, P70 to P74, P120, P125 to P127, P130, P140 to P147	-0.3 to EV _{DD} + 0.3 and -0.3 to V _{DD} + 0.3 ^{Note 2}	V
	V _{O2}	P20, P21	-0.3 to V _{DD} + 0.3 ^{Note 2}	V
Analog input voltage	V _{AI1}	ANI16 to ANI23	-0.3 to EV _{DD} + 0.3 and -0.3 to AV _{REF(+)} + 0.3 Notes 2, 3	V
	V _{AI2}	ANI0, ANI1	-0.3 to V _{DD} + 0.3 and -0.3 to AV _{REF(+)} + 0.3 Notes 2, 3	V

- Notes 1.** Connect the REGC pin to V_{SS} via a capacitor (0.47 to 1 μF). This value regulates the absolute maximum rating of the REGC pin. Do not use this pin with voltage applied to it.
- 2.** Must be 6.5 V or lower.
- 3.** Do not exceed AV_{REF(+)} + 0.3 V in case of A/D conversion target pin.

Caution Product quality may suffer if the absolute maximum rating is exceeded even momentarily for any parameter. That is, the absolute maximum ratings are rated values at which the product is on the verge of suffering physical damage, and therefore the product must be used under conditions that ensure that the absolute maximum ratings are not exceeded.

- Remarks 1.** Unless specified otherwise, the characteristics of alternate-function pins are the same as those of the port pins.
- 2.** AV_{REF(+)} : + side reference voltage of the A/D converter.
- 3.** V_{SS} : Reference voltage

Absolute Maximum Ratings (T_A = 25°C)**(2/3)**

Parameter	Symbols	Conditions	Ratings	Unit
LCD voltage	V _{L1}	V _{L1} voltage ^{Note 1}	-0.3 to +2.8 and -0.3 to V _{L4} + 0.3	V
	V _{L2}	V _{L2} voltage ^{Note 1}	-0.3 to V _{L4} + 0.3 ^{Note 2}	V
	V _{L3}	V _{L3} voltage ^{Note 1}	-0.3 to V _{L4} + 0.3 ^{Note 2}	V
	V _{L4}	V _{L4} voltage ^{Note 1}	-0.3 to +6.5	V
	V _{LCAP}	CAPL, CAPH voltage ^{Note 1}	-0.3 to V _{L4} + 0.3 ^{Note 2}	V
	V _{LOUT}	COM0 to COM7, SEG0 to SEG38, output voltage	External resistance division method	-0.3 to V _{DD} + 0.3 ^{Note 2}
	Capacitor split method		-0.3 to V _{DD} + 0.3 ^{Note 2}	
	Internal voltage boosting method		-0.3 to V _{L4} + 0.3 ^{Note 2}	

Notes 1. This value only indicates the absolute maximum ratings when applying voltage to the V_{L1}, V_{L2}, V_{L3}, and V_{L4} pins; it does not mean that applying voltage to these pins is recommended. When using the internal voltage boosting method or capacitance split method, connect these pins to V_{SS} via a capacitor (0.47 μF ± 30%) and connect a capacitor (0.47 μF ± 30%) between the CAPL and CAPH pins.

2. Must be 6.5 V or lower.

Caution Product quality may suffer if the absolute maximum rating is exceeded even momentarily for any parameter. That is, the absolute maximum ratings are rated values at which the product is on the verge of suffering physical damage, and therefore the product must be used under conditions that ensure that the absolute maximum ratings are not exceeded.

Remark V_{SS} : Reference voltage

Absolute Maximum Ratings (T_A = 25°C)**(3/3)**

Parameter	Symbols	Conditions		Ratings	Unit
Output current, high	I _{OH1}	Per pin	P10 to P17, P30 to P32, P40 to P43, P50 to P54, P70 to P74, P120, P125 to P127, P130, P140 to P147	-40	mA
		Total of all pins -170 mA	P10 to P14, P40 to P43, P120, P130, P140 to P147	-70	mA
			P15 to P17, P30 to P32, P50 to P54, P70 to P74, P125 to P127	-100	mA
	I _{OH2}	Per pin	P20, P21	-0.5	mA
		Total of all pins		-1	mA
Output current, low	I _{OL1}	Per pin	P10 to P17, P30 to P32, P40 to P43, P50 to P54, P60, P61, P70 to P74, P120, P125 to P127, P130, P140 to P147	40	mA
		Total of all pins 170 mA	P10 to P14, P40 to P43, P120, P130, P140 to P147	70	mA
			P15 to P17, P30 to P32, P50 to P54, P60, P61, P70 to P74, P125 to P127	100	mA
	I _{OL2}	Per pin	P20, P21	1	mA
		Total of all pins		2	mA
Operating ambient temperature	T _A	In normal operation mode		-40 to +85	°C
		In flash memory programming mode			
Storage temperature	T _{stg}			-65 to +150	°C

Caution Product quality may suffer if the absolute maximum rating is exceeded even momentarily for any parameter. That is, the absolute maximum ratings are rated values at which the product is on the verge of suffering physical damage, and therefore the product must be used under conditions that ensure that the absolute maximum ratings are not exceeded.

Remark Unless specified otherwise, the characteristics of alternate-function pins are the same as those of the port pins.

2.2 Oscillator Characteristics

2.2.1 X1, XT1 oscillator characteristics

(T_A = -40 to +85°C, 1.6 V ≤ EV_{DD} = V_{DD} ≤ 5.5 V, V_{SS} = EV_{SS} = 0 V)

Parameter	Resonator	Conditions	MIN.	TYP.	MAX.	Unit
X1 clock oscillation frequency (f _X) ^{Note}	Ceramic resonator/ crystal resonator	2.7 V ≤ V _{DD} ≤ 5.5 V	1.0		20.0	MHz
		2.4 V ≤ V _{DD} ≤ 2.7 V	1.0		16.0	MHz
		1.8 V ≤ V _{DD} < 2.7 V	1.0		8.0	MHz
		1.6 V ≤ V _{DD} < 1.8 V	1.0		4.0	MHz
XT1 clock oscillation frequency (f _{XT}) ^{Note}	Crystal resonator		32	32.768	35	kHz

Note Indicates only permissible oscillator frequency ranges. Refer to **2.4 AC Characteristics** for instruction execution time. Request evaluation by the manufacturer of the oscillator circuit mounted on a board to check the oscillator characteristics.

Caution Since the CPU is started by the high-speed on-chip oscillator clock after a reset release, check the X1 clock oscillation stabilization time using the oscillation stabilization time counter status register (OSTC) by the user. Determine the oscillation stabilization time of the OSTC register and the oscillation stabilization time select register (OSTS) after sufficiently evaluating the oscillation stabilization time with the resonator to be used.

2.2.2 On-chip oscillator characteristics

(T_A = -40 to +85°C, 1.6 V ≤ EV_{DD} = V_{DD} ≤ 5.5 V, V_{SS} = EV_{SS} = 0 V)

Oscillators	Parameters	Conditions		MIN.	TYP.	MAX.	Unit
High-speed on-chip oscillator clock frequency ^{Notes 1, 2}	f _H			1		24	MHz
High-speed on-chip oscillator clock frequency accuracy		-20 to +85°C	1.8 V ≤ V _{DD} ≤ 5.5 V	-1		+1	%
			1.6 V ≤ V _{DD} < 1.8 V	-5		+5	%
		-40 to -20°C	1.8 V ≤ V _{DD} ≤ 5.5 V	-1.5		+1.5	%
			1.6 V ≤ V _{DD} < 1.8 V	-5.5		+5.5	%
Low-speed on-chip oscillator clock frequency	f _L				15		kHz
Low-speed on-chip oscillator clock frequency accuracy				-15		+15	%

Notes 1. High-speed on-chip oscillator frequency is selected by bits 0 to 3 of option byte (000C2H) and bits 0 to 2 of HOCODIV register.

2. This indicates the oscillator characteristics only. Refer to **2.4 AC Characteristics** for instruction execution time.

2.3 DC Characteristics

2.3.1 Pin characteristics

(T_A = -40 to +85°C, 1.6 V ≤ EV_{DD} = V_{DD} ≤ 5.5 V, V_{SS} = EV_{SS} = 0 V)

(1/5)

Items	Symbol	Conditions	MIN.	TYP.	MAX.	Unit	
Output current, high ^{Note 1}	I _{OH1}	Per pin for P10 to P17, P30 to P32, P40 to P43, P50 to P54, P70 to P74, P120, P125 to P127, P130, P140 to P147			-10.0 Note 2	mA	
		Total of P10 to P14, P40 to P43, P120, P130, P140 to P147 (When duty = 70% ^{Note 3})	4.0 V ≤ EV _{DD} ≤ 5.5 V			-40.0	mA
			2.7 V ≤ EV _{DD} < 4.0 V			-8.0	mA
			1.8 V ≤ EV _{DD} < 2.7 V			-4.0	mA
			1.6 V ≤ EV _{DD} < 1.8 V			-2.0	mA
		Total of P15 to P17, P30 to P32, P50 to P54, P70 to P74, P125 to P127 (When duty = 70% ^{Note 3})	4.0 V ≤ EV _{DD} ≤ 5.5 V			-60.0	mA
			2.7 V ≤ EV _{DD} < 4.0 V			-15.0	mA
			1.8 V ≤ EV _{DD} < 2.7 V			-8.0	mA
			1.6 V ≤ EV _{DD} < 1.8 V			-4.0	mA
		Total of all pins (When duty = 70% ^{Note 3})					-100.0
I _{OH2}	P20, P21	Per pin			-0.1	mA	
		Total of all pins	1.6 V ≤ V _{DD} ≤ 5.5 V			-0.2	mA

Notes 1. Value of current at which the device operation is guaranteed even if the current flows from the V_{DD} and EV_{DD} pins to an output pin.

2. Do not exceed the total current value.

3. Specification under conditions where the duty factor ≤ 70%.

The output current value that has changed to the duty factor > 70% the duty ratio can be calculated with the following expression (when changing the duty factor from 70% to n%).

- Total output current of pins = (I_{OH} × 0.7)/(n × 0.01)

<Example> Where n = 80% and I_{OH} = -40.0 mA

$$\text{Total output current of pins} = (-40.0 \times 0.7)/(80 \times 0.01) \cong -35.0 \text{ mA}$$

However, the current that is allowed to flow into one pin does not vary depending on the duty factor. A current higher than the absolute maximum rating must not flow into one pin.

Caution P10, P12, P15, and P17 do not output high level in N-ch open-drain mode.

Remark Unless specified otherwise, the characteristics of alternate-function pins are the same as those of the port pins.

(T_A = -40 to +85°C, 1.6 V ≤ EV_{DD} = V_{DD} ≤ 5.5 V, V_{SS} = EV_{SS} = 0 V) (2/5)

Items	Symbol	Conditions		MIN.	TYP.	MAX.	Unit
Output current, I _{OL} ^{Note 1}	I _{OL1}	Per pin for P10 to P17, P30 to P32, P40 to P43, P50 to P54, P70 to P74, P120, P125 to P127, P130, P140 to P147				20.0 Note 2	mA
		Per pin for P60, P61				15.0 Note 2	mA
		Total of P10 to P14, P40 to P43, P120, P130, P140 to P147 (When duty = 70% ^{Note 3})	4.0 V ≤ EV _{DD} ≤ 5.5 V			70.0	mA
			2.7 V ≤ EV _{DD} < 4.0 V			15.0	mA
			1.8 V ≤ EV _{DD} < 2.7 V			9.0	mA
			1.6 V ≤ EV _{DD} < 1.8 V			4.5	mA
		Total of P15 to P17, P30 to P32, P50 to P54, P60, P61, P70 to P74, P125 to P127 (When duty = 70% ^{Note 3})	4.0 V ≤ EV _{DD} ≤ 5.5 V			80.0	mA
			2.7 V ≤ EV _{DD} < 4.0 V			35.0	mA
			1.8 V ≤ EV _{DD} < 2.7 V			20.0	mA
			1.6 V ≤ EV _{DD} < 1.8 V			10.0	mA
	Total of all pins (When duty = 70% ^{Note 3})						150.0
I _{OL2}	P20, P21	Per pin				0.4	mA
		Total of all pins		1.6 V ≤ V _{DD} ≤ 5.5 V			0.8

Notes 1. Value of current at which the device operation is guaranteed even if the current flows from the V_{DD} and EV_{DD} pins to an output pin.

2. Do not exceed the total current value.

3. Specification under conditions where the duty factor ≤ 70%.

The output current value that has changed to the duty factor > 70% the duty ratio can be calculated with the following expression (when changing the duty factor from 70% to n%).

- Total output current of pins = (I_{OH} × 0.7)/(n × 0.01)

<Example> Where n = 80% and I_{OL} = 70.0 mA

$$\text{Total output current of pins} = (70.0 \times 0.7)/(80 \times 0.01) \cong 61.25 \text{ mA}$$

However, the current that is allowed to flow into one pin does not vary depending on the duty factor. A current higher than the absolute maximum rating must not flow into one pin.

Remark Unless specified otherwise, the characteristics of alternate-function pins are the same as those of the port pins.

(T_A = -40 to +85°C, 1.6 V ≤ EV_{DD} = V_{DD} ≤ 5.5 V, V_{SS} = EV_{SS} = 0 V)

(3/5)

Items	Symbol	Conditions	MIN.	TYP.	MAX.	Unit	
Input voltage, high	V _{IH1}	P10 to P17, P30 to P32, P40 to P43, P50 to P54, P70 to P74, P120, P125 to P127, P140 to P147	Normal input buffer	0.8EV _{DD}		EV _{DD}	V
	V _{IH2}	P10, P11, P15, P16	TTL input buffer 4.0 V ≤ EV _{DD} ≤ 5.5 V	2.2		EV _{DD}	V
			TTL input buffer 3.3 V ≤ EV _{DD} < 4.0 V	2.0		EV _{DD}	V
			TTL input buffer 1.6 V ≤ EV _{DD} < 3.3 V	1.50		EV _{DD}	V
	V _{IH3}	P20, P21		0.7V _{DD}		V _{DD}	V
	V _{IH4}	P60, P61		0.7EV _{DD}		EV _{DD}	V
	V _{IH5}	P121 to P124, P137, EXCLK, EXCLKS, RESET		0.8V _{DD}		V _{DD}	V
Input voltage, low	V _{IL1}	P10 to P17, P30 to P32, P40 to P43, P50 to P54, P70 to P74, P120, P125 to P127, P140 to P147	Normal input buffer	0		0.2EV _{DD}	V
	V _{IL2}	P10, P11, P15, P16	TTL input buffer 4.0 V ≤ EV _{DD} ≤ 5.5 V	0		0.8	V
			TTL input buffer 3.3 V ≤ EV _{DD} < 4.0 V	0		0.5	V
			TTL input buffer 1.6 V ≤ EV _{DD} < 3.3 V	0		0.32	V
	V _{IL3}	P20, P21		0		0.3V _{DD}	V
	V _{IL4}	P60, P61		0		0.3EV _{DD}	V
	V _{IL5}	P121 to P124, P137, EXCLK, EXCLKS, RESET		0		0.2V _{DD}	V

Caution The maximum value of V_{IH} of P10, P12, P15, P17 is EV_{DD}, even in the N-ch open-drain mode.

Remark Unless specified otherwise, the characteristics of alternate-function pins are the same as those of the port pins.

(T_A = -40 to +85°C, 1.6 V ≤ EV_{DD} = V_{DD} ≤ 5.5 V, V_{SS} = EV_{SS} = 0 V)

(4/5)

Items	Symbol	Conditions	MIN.	TYP.	MAX.	Unit	
Output voltage, high	V _{OH1}	P10 to P17, P30 to P32, P40 to P43, P50 to P54, P70 to P74, P120, P125 to P127, P130, P140 to P147	4.0 V ≤ EV _{DD} ≤ 5.5 V, I _{OH1} = -10 mA	EV _{DD} -1.5		V	
			4.0 V ≤ EV _{DD} ≤ 5.5 V, I _{OH1} = -3.0 mA	EV _{DD} -0.7		V	
			2.7 V ≤ EV _{DD} ≤ 5.5 V, I _{OH1} = -2.0 mA	EV _{DD} -0.6		V	
			1.8 V ≤ EV _{DD} ≤ 5.5 V, I _{OH1} = -1.5 mA	EV _{DD} -0.5		V	
			1.6 V ≤ EV _{DD} ≤ 5.5 V, I _{OH1} = -1.0 mA	EV _{DD} -0.5		V	
	V _{OH2}	P20, P21	1.6 V ≤ V _{DD} ≤ 5.5 V, I _{OH2} = -100 μA	V _{DD} -0.5		V	
Output voltage, low	V _{OL1}	P10 to P17, P30 to P32, P40 to P43, P50 to P54, P70 to P74, P120, P125 to P127, P130, P140 to P147	4.0 V ≤ EV _{DD} ≤ 5.5 V, I _{OL1} = 20 mA		1.3	V	
			4.0 V ≤ EV _{DD} ≤ 5.5 V, I _{OL1} = 8.5 mA		0.7	V	
			2.7 V ≤ EV _{DD} ≤ 5.5 V, I _{OL1} = 3.0 mA		0.6	V	
			2.7 V ≤ EV _{DD} ≤ 5.5 V, I _{OL1} = 1.5 mA		0.4	V	
			1.8 V ≤ EV _{DD} ≤ 5.5 V, I _{OL1} = 0.6 mA		0.4	V	
			1.6 V ≤ EV _{DD} < 5.5 V, I _{OL1} = 0.3 mA		0.4	V	
		V _{OL2}	P20, P21	1.6 V ≤ V _{DD} ≤ 5.5 V, I _{OL2} = 400 μA		0.4	V
	V _{OL3}	P60, P61	4.0 V ≤ EV _{DD} ≤ 5.5 V, I _{OL3} = 15.0 mA		2.0	V	
			4.0 V ≤ EV _{DD} ≤ 5.5 V, I _{OL3} = 5.0 mA		0.4	V	
			2.7 V ≤ EV _{DD} ≤ 5.5 V, I _{OL3} = 3.0 mA		0.4	V	
			1.8 V ≤ EV _{DD} ≤ 5.5 V, I _{OL3} = 2.0 mA		0.4	V	
			1.6 V ≤ EV _{DD} < 5.5 V, I _{OL3} = 1.0 mA		0.4	V	

Caution P10, P12, P15, P17 do not output high level in N-ch open-drain mode.

Remark Unless specified otherwise, the characteristics of alternate-function pins are the same as those of the port pins.

(T_A = -40 to +85°C, 1.6 V ≤ EV_{DD} = V_{DD} ≤ 5.5 V, V_{SS} = EV_{SS} = 0 V)

(5/5)

Items	Symbol	Conditions	MIN.	TYP.	MAX.	Unit		
Input leakage current, high	I _{LIH1}	P10 to P17, P30 to P32, P40 to P43, P50 to P54, P60, P61, P70 to P74, P120, P125 to P127, P140 to P147	V _I = EV _{DD}			1	μA	
	I _{LIH2}	P20, P21, P137, RESET	V _I = V _{DD}			1	μA	
	I _{LIH3}	P121 to P124 (X1, X2, XT1, XT2, EXCLK, EXCLKS)	V _I = V _{DD}	In input port or external clock input			1	μA
				In resonator connection			10	μA
Input leakage current, low	I _{LIL1}	P10 to P17, P30 to P32, P40 to P43, P50 to P54, P60, P61, P70 to P74, P120, P125 to P127, P140 to P147	V _I = EV _{SS}			-1	μA	
	I _{LIL2}	P20, P21, P137, RESET	V _I = V _{SS}			-1	μA	
	I _{LIL3}	P121 to P124 (X1, X2, XT1, XT2, EXCLK, EXCLKS)	V _I = V _{SS}	In input port or external clock input			-1	μA
				In resonator connection			-10	μA
On-chip pll-up resistance	R _{U1}	V _I = EV _{SS}	SEGxx port					
			2.4 V ≤ EV _{DD} = V _{DD} ≤ 5.5 V	10	20	100	kΩ	
			1.6 V ≤ EV _{DD} = V _{DD} < 2.4 V	10	30	100	kΩ	
	R _{U2}		Ports other than above (Except for P60, P61, and P130)		10	20	100	kΩ

Remark Unless specified otherwise, the characteristics of alternate-function pins are the same as those of the port pins.

2.3.2 Supply current characteristics

(T_A = -40 to +85°C, 1.6 V ≤ E_{VDD} = V_{DD} ≤ 5.5 V, V_{SS} = E_{VSS} = 0 V)

(1/3)

Parameter	Symbol	Conditions				MIN.	TYP.	MAX.	Unit		
Supply current Note 1	I _{DD1}	Operating mode	HS (high-speed main) mode ^{Note 5}	f _{IH} = 24 MHz ^{Note 3}	Basic operation	V _{DD} = 5.0 V		1.5		mA	
						V _{DD} = 3.0 V		1.5		mA	
					Normal operation	V _{DD} = 5.0 V		3.3	5.0	mA	
					V _{DD} = 3.0 V		3.3	5.0	mA		
					f _{IH} = 16 MHz ^{Note 3}	Normal operation	V _{DD} = 5.0 V		2.5	3.7	mA
							V _{DD} = 3.0 V		2.5	3.7	mA
				LS (low-speed main) mode ^{Note 5}	f _{IH} = 8 MHz ^{Note 3}	Normal operation	V _{DD} = 3.0 V		1.2	1.8	mA
							V _{DD} = 2.0 V		1.2	1.8	mA
				LV (low-voltage main) mode ^{Note 5}	f _{IH} = 4 MHz ^{Note 3}	Normal operation	V _{DD} = 3.0 V		1.2	1.7	mA
							V _{DD} = 2.0 V		1.2	1.7	mA
				HS (high-speed main) mode ^{Note 5}	f _{MX} = 20 MHz ^{Note 2} , V _{DD} = 5.0 V	Normal operation	Square wave input		2.8	4.4	mA
						Resonator connection		3.0	4.6	mA	
			f _{MX} = 20 MHz ^{Note 2} , V _{DD} = 3.0 V		Normal operation	Square wave input		2.8	4.4	mA	
						Resonator connection		3.0	4.6	mA	
			f _{MX} = 10 MHz ^{Note 2} , V _{DD} = 5.0 V		Normal operation	Square wave input		1.8	2.6	mA	
						Resonator connection		1.8	2.6	mA	
			f _{MX} = 10 MHz ^{Note 2} , V _{DD} = 3.0 V		Normal operation	Square wave input		1.8	2.6	mA	
						Resonator connection		1.8	2.6	mA	
			LS (low-speed main) mode ^{Note 5}	f _{MX} = 8 MHz ^{Note 2} , V _{DD} = 3.0 V	Normal operation	Square wave input		1.1	1.7	mA	
					Resonator connection		1.1	1.7	mA		
				f _{MX} = 8 MHz ^{Note 2} , V _{DD} = 2.0 V	Normal operation	Square wave input		1.1	1.7	mA	
						Resonator connection		1.1	1.7	mA	
			Subsystem clock operation	f _{SUB} = 32.768 kHz ^{Note 4} T _A = -40°C	Normal operation	Square wave input		3.5	4.9	μA	
					Resonator connection		3.6	5.0	μA		
	f _{SUB} = 32.768 kHz ^{Note 4} T _A = +25°C	Normal operation		Square wave input		3.6	4.9	μA			
				Resonator connection		3.7	5.0	μA			
	f _{SUB} = 32.768 kHz ^{Note 4} T _A = +50°C	Normal operation		Square wave input		3.7	5.5	μA			
				Resonator connection		3.8	5.6	μA			
	f _{SUB} = 32.768 kHz ^{Note 4} T _A = +70°C	Normal operation		Square wave input		3.8	6.3	μA			
				Resonator connection		3.9	6.4	μA			
	f _{SUB} = 32.768 kHz ^{Note 4} T _A = +85°C	Normal operation	Square wave input		4.1	7.7	μA				
			Resonator connection		4.2	7.8	μA				

(Notes and Remarks are listed on the next page.)

- Notes**
1. Total current flowing into V_{DD} and EV_{DD}, including the input leakage current flowing when the level of the input pin is fixed to V_{DD}, EV_{DD} or V_{SS}, EV_{SS}. The values below the MAX. column include the peripheral operation current. However, not including the current flowing into the A/D converter, LVD circuit, I/O port, and on-chip pull-up/pull-down resistors and the current flowing during data flash rewrite.
 2. When high-speed on-chip oscillator and subsystem clock are stopped.
 3. When high-speed system clock and subsystem clock are stopped.
 4. When high-speed on-chip oscillator and high-speed system clock are stopped. When AMPHS1 = 1 (Ultra-low power consumption oscillation). However, not including the current flowing into the RTC, 12-bit interval timer, watchdog timer, and LCD controller/driver.
 5. Relationship between operation voltage width, operation frequency of CPU and operation mode is as below.
 - HS (high-speed main) mode: $2.7\text{ V} \leq V_{DD} \leq 5.5\text{ V}@1\text{ MHz to }24\text{ MHz}$
 $2.4\text{ V} \leq V_{DD} \leq 5.5\text{ V}@1\text{ MHz to }16\text{ MHz}$
 - LS (low-speed main) mode: $1.8\text{ V} \leq V_{DD} \leq 5.5\text{ V}@1\text{ MHz to }8\text{ MHz}$
 - LV (low-voltage main) mode: $1.6\text{ V} \leq V_{DD} \leq 5.5\text{ V}@1\text{ MHz to }4\text{ MHz}$

- Remarks**
1. f_{MX}: High-speed system clock frequency (X1 clock oscillation frequency or external main system clock frequency)
 2. f_{IH}: High-speed on-chip oscillator clock frequency
 3. f_{SUB}: Subsystem clock frequency (XT1 clock oscillation frequency)
 4. Except subsystem clock operation, temperature condition of the TYP. value is T_A = 25°C

(T_A = -40 to +85°C, 1.6 V ≤ EV_{DD} = V_{DD} ≤ 5.5 V, V_{SS} = EV_{SS} = 0 V)

(2/3)

Parameter	Symbol	Conditions			MIN.	TYP.	MAX.	Unit	
Supply current Note 1	I _{DD2} Note 2	HALT mode	HS (high-speed main) mode Note 7	f _{IH} = 24 MHz Note 4	V _{DD} = 5.0 V	0.44	1.28	mA	
					V _{DD} = 3.0 V	0.44	1.28	mA	
				f _{IH} = 16 MHz Note 4	V _{DD} = 5.0 V	0.40	1.00	mA	
					V _{DD} = 3.0 V	0.40	1.00	mA	
				LS (low-speed main) mode Note 7	f _{IH} = 8 MHz Note 4	V _{DD} = 3.0 V	260	530	μA
						V _{DD} = 2.0 V	260	530	μA
			LV (low-voltage main) mode Note 7	f _{IH} = 4 MHz Note 4	V _{DD} = 3.0 V	420	640	μA	
					V _{DD} = 2.0 V	420	640	μA	
			HS (high-speed main) mode Note 7	f _{MX} = 20 MHz Note 3, V _{DD} = 5.0 V	Square wave input	0.28	1.00	mA	
					Resonator connection	0.45	1.17	mA	
				f _{MX} = 20 MHz Note 3, V _{DD} = 3.0 V	Square wave input	0.28	1.00	mA	
					Resonator connection	0.45	1.17	mA	
		f _{MX} = 10 MHz Note 3, V _{DD} = 5.0 V		Square wave input	0.19	0.60	mA		
				Resonator connection	0.26	0.67	mA		
		f _{MX} = 10 MHz Note 3, V _{DD} = 3.0 V	Square wave input	0.19	0.60	mA			
			Resonator connection	0.26	0.67	mA			
		LS (low-speed main) mode Note 7	f _{MX} = 8 MHz Note 3, V _{DD} = 3.0 V	Square wave input	95	330	μA		
				Resonator connection	145	380	μA		
			f _{MX} = 8 MHz Note 3, V _{DD} = 2.0 V	Square wave input	95	330	μA		
				Resonator connection	145	380	μA		
		Subsystem clock operation	f _{SUB} = 32.768 kHz Note 5 T _A = -40°C	Square wave input	0.31	0.57	μA		
				Resonator connection	0.50	0.76	μA		
			f _{SUB} = 32.768 kHz Note 5 T _A = +25°C	Square wave input	0.37	0.57	μA		
				Resonator connection	0.56	0.76	μA		
f _{SUB} = 32.768 kHz Note 5 T _A = +50°C	Square wave input		0.46	1.17	μA				
	Resonator connection		0.65	1.36	μA				
f _{SUB} = 32.768 kHz Note 5 T _A = +70°C	Square wave input		0.57	1.97	μA				
	Resonator connection		0.76	2.16	μA				
f _{SUB} = 32.768 kHz Note 5 T _A = +85°C	Square wave input	0.85	3.37	μA					
	Resonator connection	1.04	3.56	μA					
I _{DD3} Note 6	STOP mode Note 8	T _A = -40°C			0.17	0.50	μA		
		T _A = +25°C			0.23	0.50	μA		
		T _A = +50°C			0.32	1.10	μA		
		T _A = +70°C			0.43	1.90	μA		
		T _A = +85°C			0.71	3.30	μA		

(Notes and Remarks are listed on the next page.)

- Notes**
1. Total current flowing into V_{DD} and EV_{DD}, including the input leakage current flowing when the level of the input pin is fixed to V_{DD}, EV_{DD} or V_{SS}, EV_{SS}. The values below the MAX. column include the peripheral operation current. However, not including the current flowing into the A/D converter, LVD circuit, I/O port, and on-chip pull-up/pull-down resistors and the current flowing during data flash rewrite.
 2. During HALT instruction execution by flash memory.
 3. When high-speed on-chip oscillator and subsystem clock are stopped.
 4. When high-speed system clock and subsystem clock are stopped.
 5. When high-speed on-chip oscillator and high-speed system clock are stopped. When RTCLPC = 1 and setting ultra-low current consumption (AMPHS1 = 1). The current flowing into the RTC is included. However, not including the current flowing into the 12-bit interval timer, watchdog timer, and LCD controller/driver.
 6. Not including the current flowing into the RTC, 12-bit interval timer, and watchdog timer.
 7. Relationship between operation voltage width, operation frequency of CPU and operation mode is as below.
 - HS (high-speed main) mode: $2.7\text{ V} \leq V_{DD} \leq 5.5\text{ V}@1\text{ MHz to }24\text{ MHz}$
 $2.4\text{ V} \leq V_{DD} \leq 5.5\text{ V}@1\text{ MHz to }16\text{ MHz}$
 - LS (low-speed main) mode: $1.8\text{ V} \leq V_{DD} \leq 5.5\text{ V}@1\text{ MHz to }8\text{ MHz}$
 - LV (low-voltage main) mode: $1.6\text{ V} \leq V_{DD} \leq 5.5\text{ V}@1\text{ MHz to }4\text{ MHz}$
 8. Regarding the value for current to operate the subsystem clock in STOP mode, refer to that in HALT mode.

- Remarks**
1. f_{MX}: High-speed system clock frequency (X1 clock oscillation frequency or external main system clock frequency)
 2. f_{IH}: High-speed on-chip oscillator clock frequency
 3. f_{SUB}: Subsystem clock frequency (XT1 clock oscillation frequency)
 4. Except subsystem clock operation and STOP mode, temperature condition of the TYP. value is T_A = 25°C

(T_A = -40 to +85°C, 1.6 V ≤ EV_{DD} = V_{DD} ≤ 5.5 V, V_{SS} = EV_{SS} = 0 V)

(3/3)

Parameter	Symbol	Conditions		MIN.	TYP.	MAX.	Unit
Low-speed on-chip oscillator operating current	I _{FIL} ^{Note 1}				0.20		μA
RTC operating current	I _{RTC} Notes 1, 2, 3	f _{MAIN} is stopped			0.08		μA
12-bit interval timer current	I _{IT} Notes 1, 2, 4				0.08		μA
Watchdog timer operating current	I _{WDT} Notes 1, 2, 5	f _{IL} = 15 kHz			0.24		μA
A/D converter operating current	I _{ADC} Notes 1, 6	When conversion at maximum speed	Normal mode, AV _{REFP} = V _{DD} = 5.0 V		1.3	1.7	mA
			Low voltage mode, AV _{REFP} = V _{DD} = 3.0 V		0.5	0.7	mA
A/D converter reference voltage current	I _{ADREF} ^{Note 1}				75.0		μA
Temperature sensor operating current	I _{TMPS} ^{Note 1}				75.0		μA
LVD operating current	I _{LVD} Notes 1, 7				0.08		μA
Self-programming operating current	I _{FSP} Notes 1, 9				2.50	12.20	mA
BGO operating current	I _{BGO} Notes 1, 8				2.00	12.20	mA
LCD operating current	I _{LCD1} Notes 11, 12	External resistance division method	V _{DD} = EV _{DD} = 5.0 V V _{L4} = 5.0 V		0.04	0.20	μA
		I _{LCD2} ^{Note 11}	Internal voltage boosting method	V _{DD} = EV _{DD} = 5.0 V V _{L4} = 5.1 V (VLCD = 12H)		1.12	3.70
	V _{DD} = EV _{DD} = 3.0 V V _{L4} = 3.0 V (VLCD = 04H)				0.63	2.20	μA
	I _{LCD3} ^{Note 11}	Capacitor split method	V _{DD} = EV _{DD} = 3.0 V V _{L4} = 3.0 V		0.12	0.50	μA
SNOOZE operating current	I _{SNOZ} ^{Note 1}	ADC operation	The mode is performed ^{Note 10}		0.50	0.60	mA
			The A/D conversion operations are performed, Low voltage mode, AV _{REFP} = V _{DD} = 3.0 V		1.20	1.44	mA
		CSI/UART operation		0.70	0.84	mA	

(Notes and Remarks are listed on the next page.)

- Notes**
1. Current flowing to V_{DD}.
 2. When high speed on-chip oscillator and high-speed system clock are stopped.
 3. Current flowing only to the real-time clock (RTC) (excluding the operating current of the low-speed on-chip oscillator and the XT1 oscillator). The supply current of the RL78 microcontrollers is the sum of the values of either I_{DD1} or I_{DD2}, and I_{RTC}, when the real-time clock operates in operation mode or HALT mode. When the low-speed on-chip oscillator is selected, I_{FIL} should be added. I_{DD2} subsystem clock operation includes the operational current of the real-time clock.
 4. Current flowing only to the 12-bit interval timer (excluding the operating current of the low-speed on-chip oscillator and the XT1 oscillator). The supply current of the RL78 microcontrollers is the sum of the values of either I_{DD1} or I_{DD2}, and I_{IT}, when the 12-bit interval timer operates in operation mode or HALT mode. When the low-speed on-chip oscillator is selected, I_{FIL} should be added.
 5. Current flowing only to the watchdog timer (including the operating current of the low-speed on-chip oscillator). The supply current of the RL78 microcontrollers is the sum of I_{DD1}, I_{DD2} or I_{DD3} and I_{WDT} when the watchdog timer is in operation.
 6. Current flowing only to the A/D converter. The supply current of the RL78 microcontrollers is the sum of I_{DD1} or I_{DD2} and I_{ADC} when the A/D converter operates in an operation mode or the HALT mode.
 7. Current flowing only to the LVD circuit. The supply current of the RL78 microcontrollers is the sum of I_{DD1}, I_{DD2} or I_{DD3} and I_{LVD} when the LVD circuit is in operation.
 8. Current flowing only during data flash rewrite.
 9. Current flowing only during self programming.
 10. For shift time to the SNOOZE mod.
 11. Current flowing only to the LCD controller/driver. The supply current value of the RL78 microcontrollers is the sum of the LCD operating current (I_{LCD1}, I_{LCD2} or I_{LCD3}) to the supply current (I_{DD1} or I_{DD2}) when the LCD controller/driver operates in an operation mode or HALT mode. Not including the current that flows through the LCD panel.
The TYP. value and MAX. value are following conditions.
 - When f_{SUB} is selected for system clock, LCD clock = 128 Hz (LCDC0 = 07H)
 - 4-Time-Slice, 1/3 Bias Method
 12. Not including the current that flows through the external divider resistor when the external resistance division method is used.

- Remarks**
1. f_{FIL}: Low-speed on-chip oscillator clock frequency
 2. f_{SUB}: Subsystem clock frequency (XT1 clock oscillation frequency)
 3. f_{CLK}: CPU/peripheral hardware clock frequency
 4. Temperature condition of the TYP. value is T_A = 25°C

2.4 AC Characteristics

2.4.1 Basic operation

(T_A = -40 to +85°C, 1.6 V ≤ EV_{DD} = V_{DD} ≤ 5.5 V, V_{SS} = EV_{SS} = 0 V)

Items	Symbol	Conditions		MIN.	TYP.	MAX.	Unit		
Instruction cycle (minimum instruction execution time)	T _{cy}	Main system clock (f _{MAIN}) operation	HS (high-speed main) mode	2.7 V ≤ V _{DD} ≤ 5.5 V	0.04167		1	μs	
				2.4 V ≤ V _{DD} < 2.7 V	0.0625		1	μs	
			LV (low voltage main) mode	1.6 V ≤ V _{DD} ≤ 5.5 V	0.25		1	μs	
			LS (low-speed main) mode	1.8 V ≤ V _{DD} ≤ 5.5 V	0.125		1	μs	
			Subsystem clock (f _{SUB}) operation		1.8 V ≤ V _{DD} ≤ 5.5 V	28.5	30.5	31.3	μs
			In the self programming mode	HS (high-speed main) mode	2.7 V ≤ V _{DD} ≤ 5.5 V	0.04167		1	μs
				2.4 V ≤ V _{DD} < 2.7 V	0.0625		1	μs	
				LV (low voltage main) mode	1.8 V ≤ V _{DD} ≤ 5.5 V	0.25		1	μs
	LS (low-speed main) mode	1.8 V ≤ V _{DD} ≤ 5.5 V		0.125		1	μs		
External main system clock frequency	f _{EX}	2.7 V ≤ V _{DD} ≤ 5.5 V		1.0		20.0	MHz		
		2.4 V ≤ V _{DD} < 2.7 V		1.0		16.0	MHz		
		1.8 V ≤ V _{DD} < 2.4 V		1.0		8.0	MHz		
		1.6 V ≤ V _{DD} < 1.8 V		1.0		4.0	MHz		
	f _{EXS}			32		35	kHz		
External main system clock input high-level width, low-level width	t _{EXH} , t _{EXL}	2.7 V ≤ V _{DD} ≤ 5.5 V		24			ns		
		2.4 V ≤ V _{DD} < 2.7 V		30			ns		
		1.8 V ≤ V _{DD} < 2.4 V		60			ns		
		1.6 V ≤ V _{DD} < 1.8 V		120			ns		
	t _{EXHS} , t _{EXLS}			13.7			μs		
TI00 to TI07 input high-level width, low-level width	t _{TIH} , t _{TIL}			1/f _{MCK} +10			ns		
TO00 to TO07 output frequency	f _{TO}	HS (high-speed main) mode	4.0 V ≤ EV _{DD} ≤ 5.5 V			16	MHz		
			2.7 V ≤ EV _{DD} < 4.0 V			8	MHz		
			2.4 V ≤ EV _{DD} < 2.7 V			4	MHz		
		LS (low-speed main) mode	1.8 V ≤ EV _{DD} ≤ 5.5 V			4	MHz		
		LV (low voltage main) mode	1.6 V ≤ EV _{DD} ≤ 5.5 V			2	MHz		
PCLBUZ0, PCLBUZ1 output frequency	f _{PCL}	HS (high-speed main) mode	4.0 V ≤ EV _{DD} ≤ 5.5 V			16	MHz		
			2.7 V ≤ EV _{DD} < 4.0 V			8	MHz		
			2.4 V ≤ EV _{DD} < 2.7 V			4	MHz		
		LS (low-speed main) mode	1.8 V ≤ EV _{DD} ≤ 5.5 V			4	MHz		
		LV (low-voltage main) mode	1.8 V ≤ EV _{DD} ≤ 5.5 V			4	MHz		
		1.6 V ≤ EV _{DD} < 1.8 V			2	MHz			
Interrupt input high-level width, low-level width	t _{INTH} , t _{INTL}	INTP0	1.6 V ≤ V _{DD} ≤ 5.5 V	1			μs		
		INTP1 to INTP7	1.6 V ≤ EV _{DD} ≤ 5.5 V	1			μs		
Key interrupt input low-level width	t _{KR}	KR0 to KR3	1.8 V ≤ EV _{DD} ≤ 5.5 V	250			ns		
			1.6 V ≤ EV _{DD} < 1.8 V	1			μs		
RESET low-level width	t _{RSL}			10			μs		

Remark f_{MCK}: Timer array unit operation clock frequency

(Operation clock to be set by the CKS0n bit of timer mode register 0n (TMR0n). n: Channel number (n = 0 to 7))

Minimum Instruction Execution Time during Main System Clock Operation

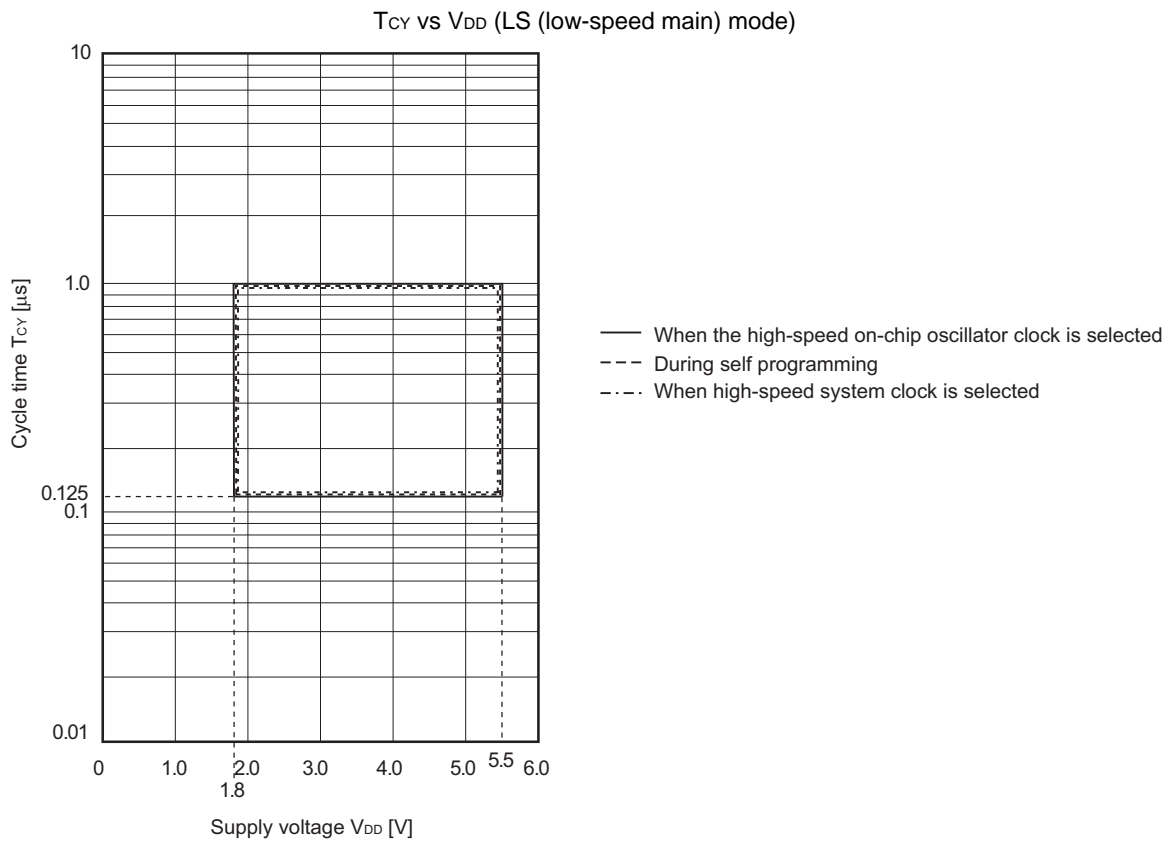
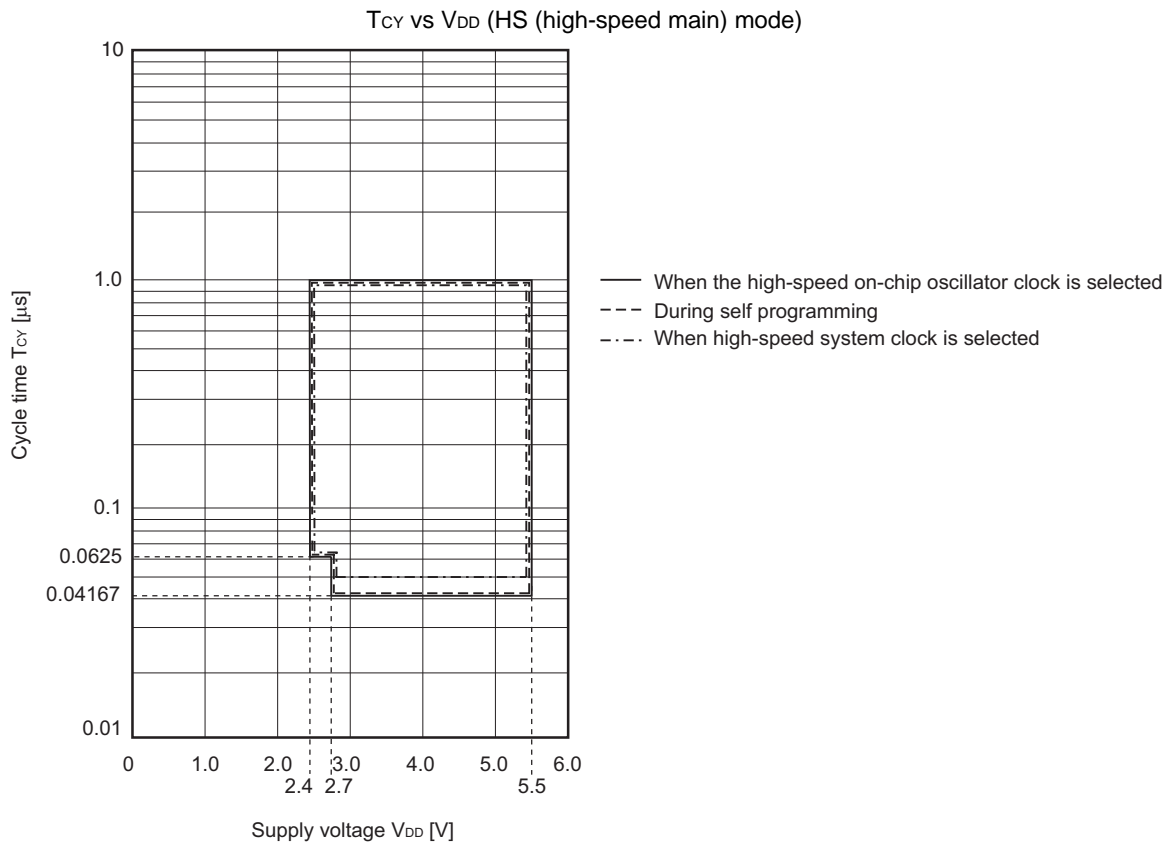

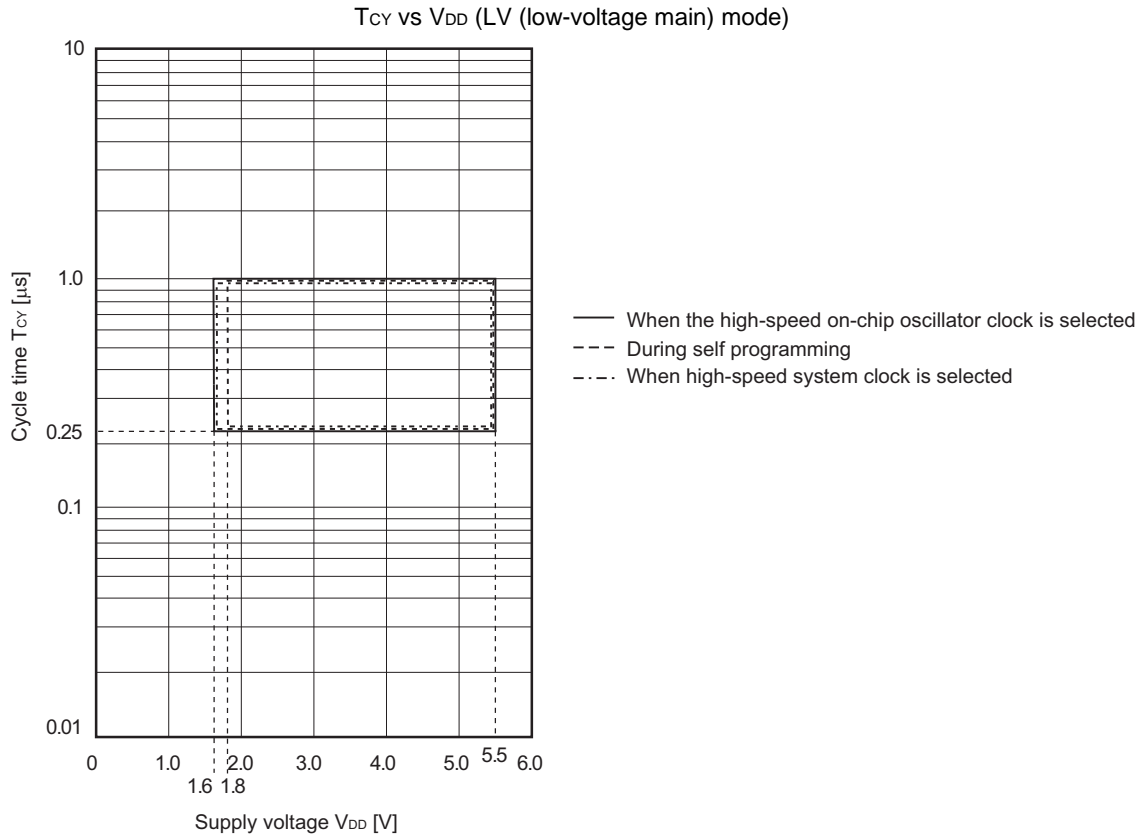

AC Timing Test Points



External System Clock Timing

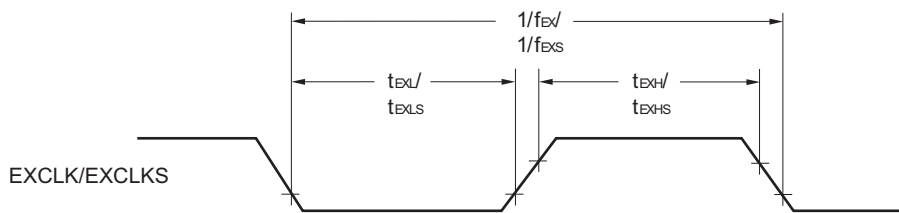

TI/TO Timing

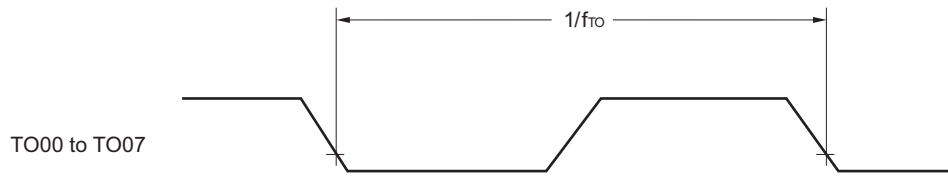
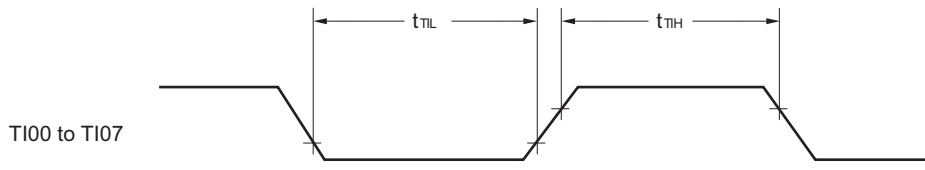

Interrupt Request Input Timing

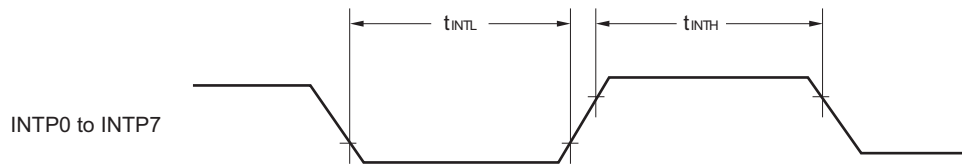

Key Interrupt Input Timing

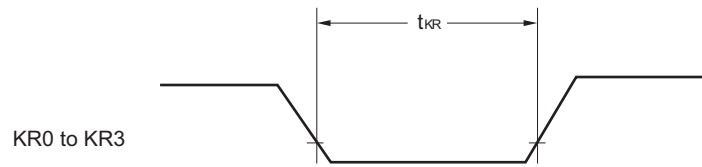

RESET Input Timing

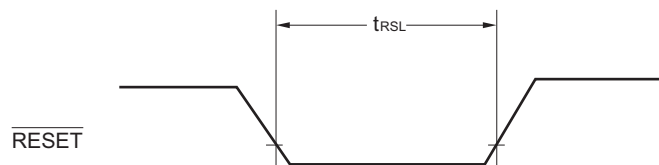

2.5 Peripheral Functions Characteristics

AC Timing Test Points

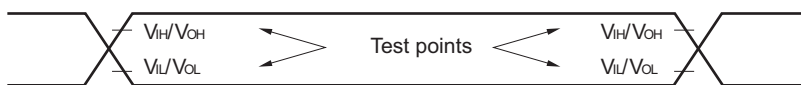

2.5.1 Serial array unit

(1) During communication at same potential (UART mode)

(T_A = -40 to +85°C, 1.6 V ≤ EV_{DD} = V_{DD} ≤ 5.5 V, V_{SS} = EV_{SS} = 0 V)

Parameter	Symbol	Conditions	HS (high-speed main) Mode		LS (low-speed main) Mode		LV (low-voltage main) Mode		Unit
			MIN.	MAX.	MIN.	MAX.	MIN.	MAX.	
Transfer rate ^{Note 1}		2.4 V ≤ EV _{DD} = V _{DD} ≤ 5.5 V		f _{MCK} /6		f _{MCK} /6		f _{MCK} /6	bps
		Theoretical value of the maximum transfer rate f _{MCK} = f _{CLK} ^{Note 2}		4.0		1.3		0.6	Mbps
		1.8 V ≤ EV _{DD} = V _{DD} ≤ 5.5 V				f _{MCK} /6		f _{MCK} /6	bps
		Theoretical value of the maximum transfer rate f _{MCK} = f _{CLK} ^{Note 2}				1.3		0.6	Mbps
		1.6 V ≤ EV _{DD} = V _{DD} ≤ 5.5 V						f _{MCK} /6	bps
		Theoretical value of the maximum transfer rate f _{MCK} = f _{CLK} ^{Note 2}						0.6	Mbps

Notes 1. Transfer rate in the SNOOZE mode is 4800 bps only.

2. The maximum operating frequencies of the CPU/peripheral hardware clock (f_{CLK}) are:

HS (high-speed main) mode: 24 MHz (2.7 V ≤ V_{DD} ≤ 5.5 V)

16 MHz (2.4 V ≤ V_{DD} ≤ 5.5 V)

LS (low-speed main) mode: 8 MHz (1.8 V ≤ V_{DD} ≤ 5.5 V)

LV (low-voltage main) mode: 4 MHz (1.6 V ≤ V_{DD} ≤ 5.5 V)

Caution Select the normal input buffer for the RxDq pin and the normal output mode for the TxDq pin by using port input mode register g (PIMg) and port output mode register g (POMg).

UART mode connection diagram (during communication at same potential)

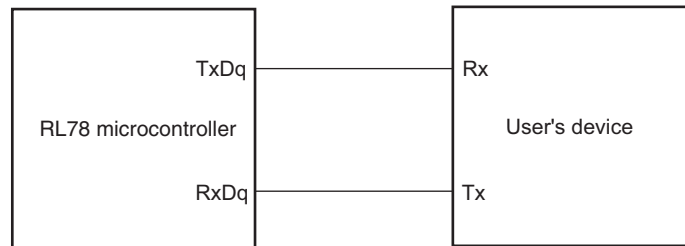

UART mode bit width (during communication at same potential) (reference)

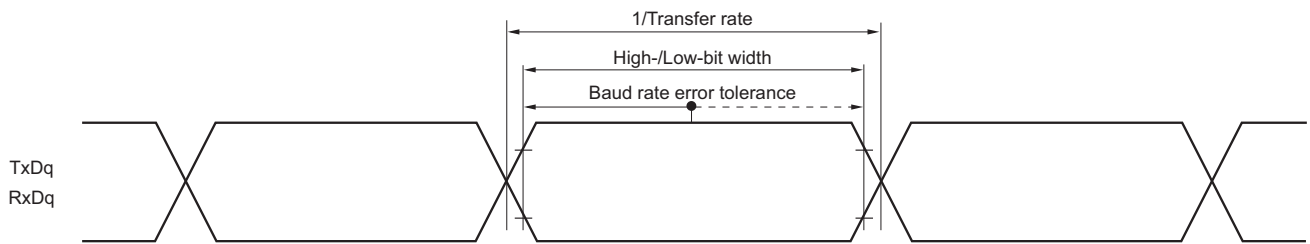

- Remarks**
1. q: UART number (q = 0), g: PIM and POM number (g = 1)
 2. f_{MCK} : Serial array unit operation clock frequency
 (Operation clock to be set by the serial clock select register m (SPSm) and the CKSmn bit of serial mode register mn (SMRmn). m: Unit number, n: Channel number (mn = 00, 01))

(2) During communication at same potential (CSI mode) (master mode, SCKp... internal clock output)
(T_A = -40 to +85°C, 1.6 V ≤ EV_{DD} = V_{DD} ≤ 5.5 V, V_{SS} = EV_{SS} = 0 V)

Parameter	Symbol	Conditions	HS (high-speed main) Mode		LS (low-speed main) Mode		LV (low-voltage main) Mode		Unit
			MIN.	MAX.	MIN.	MAX.	MIN.	MAX.	
SCKp cycle time	t _{KCY1}	2.7 V ≤ EV _{DD} ≤ 5.5 V	167 Note 1		500 Note 1		1000 Note 1		ns
		2.4 V ≤ EV _{DD} ≤ 5.5 V	250 Note 1		500 Note 1		1000 Note 1		ns
		1.8 V ≤ EV _{DD} ≤ 5.5 V			500 Note 1		1000 Note 1		ns
		1.6 V ≤ EV _{DD} ≤ 5.5 V					1000 Note 1		ns
SCKp high-/low-level width	t _{KH1} , t _{KL1}	4.0 V ≤ EV _{DD} ≤ 5.5 V	t _{KCY1} /2 - 12		t _{KCY1} /2 - 50		t _{KCY1} /2 - 50		ns
		2.7 V ≤ EV _{DD} ≤ 5.5 V	t _{KCY1} /2 - 18		t _{KCY1} /2 - 50		t _{KCY1} /2 - 50		ns
		2.4 V ≤ EV _{DD} ≤ 5.5 V	t _{KCY1} /2 - 38		t _{KCY1} /2 - 50		t _{KCY1} /2 - 50		ns
		1.8 V ≤ EV _{DD} ≤ 5.5 V			t _{KCY1} /2 - 50		t _{KCY1} /2 - 50		ns
		1.6 V ≤ EV _{DD} ≤ 5.5 V					t _{KCY1} /2 - 100		ns
Slp setup time (to SCKp↑) Note 2	t _{SIK1}	2.7 V ≤ EV _{DD} ≤ 5.5 V	44		110		110		ns
		2.4 V ≤ EV _{DD} ≤ 5.5 V	75		110		110		ns
		1.8 V ≤ EV _{DD} ≤ 5.5 V			110		110		ns
		1.6 V ≤ EV _{DD} ≤ 5.5 V					220		ns
Slp hold time (from SCKp↑) Note 3	t _{KSH1}	2.4 V ≤ EV _{DD} ≤ 5.5 V	19		19		19		ns
		1.8 V ≤ EV _{DD} ≤ 5.5 V			19		19		ns
		1.6 V ≤ EV _{DD} ≤ 5.5 V					19		ns
Delay time from SCKp↓ to SOP output Note 4	t _{KSO1}	C = 30 pF Note 5	2.4 V ≤ EV _{DD} ≤ 5.5 V		25		25	25	ns
			1.8 V ≤ EV _{DD} ≤ 5.5 V				25	25	
			1.6 V ≤ EV _{DD} ≤ 5.5 V					25	

Notes 1. For CSI00, set a cycle of 2/f_{MCK} or longer. For CSI01, set a cycle of 4/f_{MCK} or longer.

- When DAP_mn = 0 and CKP_mn = 0, or DAP_mn = 1 and CKP_mn = 1. The Slp setup time becomes “to SCKp↓” when DAP_mn = 0 and CKP_mn = 1, or DAP_mn = 1 and CKP_mn = 0.
- When DAP_mn = 0 and CKP_mn = 0, or DAP_mn = 1 and CKP_mn = 1. The Slp hold time becomes “from SCKp↓” when DAP_mn = 0 and CKP_mn = 1, or DAP_mn = 1 and CKP_mn = 0.
- When DAP_mn = 0 and CKP_mn = 0, or DAP_mn = 1 and CKP_mn = 1. The delay time to SOP output becomes “from SCKp↑” when DAP_mn = 0 and CKP_mn = 1, or DAP_mn = 1 and CKP_mn = 0.
- C is the load capacitance of the SCKp and SOP output lines.

Caution Select the normal input buffer for the Slp pin and the normal output mode for the SOP pin and SCKp pin by using port input mode register g (PIMg) and port output mode register g (POMg).

(Remarks are listed on the next page.)

- Remarks 1.** p: CSI number (p = 00, 01), m: Unit number (m = 0), n: Channel number (n = 0, 1),
 g: PIM and POM numbers (g = 1)
- 2.** f_{MCK}: Serial array unit operation clock frequency
 (Operation clock to be set by the serial clock select register m (SPS_m) and the CKS_{mn} bit of serial mode register mn (SMR_{mn}).
 m: Unit number, n: Channel number (mn = 00, 01))

(3) During communication at same potential (CSI mode) (slave mode, SCKp... external clock input) (1/2)
 (T_A = -40 to +85°C, 1.6 V ≤ EV_{DD} = V_{DD} ≤ 5.5 V, V_{SS} = EV_{SS} = 0 V)

Parameter	Symbol	Conditions		HS (high-speed main) Mode		LS (low-speed main) Mode		LV (low-voltage main) Mode		Unit	
				MIN.	MAX.	MIN.	MAX.	MIN.	MAX.		
SCKp cycle time ^{Note 5}	tkCY2	4.0 V ≤ EV _{DD} ≤ 5.5 V	20 MHz < f _{MCK}	8/f _{MCK}						ns	
			f _{MCK} ≤ 20 MHz	6/f _{MCK}		6/f _{MCK}		6/f _{MCK}		ns	
		2.7 V ≤ EV _{DD} < 4.0 V	16 MHz < f _{MCK}	8/f _{MCK}						ns	
			f _{MCK} ≤ 16 MHz	6/f _{MCK}		6/f _{MCK}		6/f _{MCK}		ns	
		2.4 V ≤ EV _{DD} ≤ 5.5 V			6/f _{MCK} and 500		6/f _{MCK}		6/f _{MCK}		ns
		1.8 V ≤ EV _{DD} < 2.4 V					6/f _{MCK}		6/f _{MCK}		ns
		1.6 V ≤ EV _{DD} < 1.8 V							6/f _{MCK}		ns
SCKp high-/low-level width	tkH2, tkL2	4.0 V ≤ EV _{DD} ≤ 5.5 V		tkCY2/2 - 7		tkCY2/2 - 7		tkCY2/2 - 7		ns	
		2.7 V ≤ EV _{DD} < 4.0 V		tkCY2/2 - 8		tkCY2/2 - 8		tkCY2/2 - 8		ns	
		2.4 V ≤ EV _{DD} < 2.7 V		tkCY2/2 - 18		tkCY2/2 - 18		tkCY2/2 - 18		ns	
		1.8 V ≤ EV _{DD} < 2.4 V				tkCY2/2 - 18		tkCY2/2 - 18		ns	
		1.6 V ≤ EV _{DD} < 1.8 V						tkCY2/2 - 66		ns	
Slp setup time (to SCKp↑) ^{Note 1}	tSIK2	2.7 V ≤ EV _{DD} ≤ 5.5 V		1/f _{MCK} + 20		1/f _{MCK} + 30		1/f _{MCK} + 30		ns	
		2.4 V ≤ EV _{DD} < 2.7 V		1/f _{MCK} + 30		1/f _{MCK} + 30		1/f _{MCK} + 30			
		1.8 V ≤ EV _{DD} < 2.4 V				1/f _{MCK} + 30		1/f _{MCK} + 30		ns	
		1.6 V ≤ EV _{DD} < 1.8 V						1/f _{MCK} + 40		ns	
Slp hold time (from SCKp↑) ^{Note 2}	tKSI2	2.4 V ≤ EV _{DD} ≤ 5.5 V		1/f _{MCK} + 31		1/f _{MCK} + 31		1/f _{MCK} + 31		ns	
		1.8 V ≤ EV _{DD} < 2.4 V				1/f _{MCK} + 31		1/f _{MCK} + 31		ns	
		1.6 V ≤ EV _{DD} < 1.8 V						1/f _{MCK} + 250		ns	

(Notes, Caution, and Remarks are listed on the next page.)

(3) During communication at same potential (CSI mode) (slave mode, SCKp... external clock input) (2/2)
(T_A = -40 to +85°C, 1.6 V ≤ EV_{DD} = V_{DD} ≤ 5.5 V, V_{SS} = EV_{SS} = 0 V)

Parameter	Symbol	Conditions	HS (high-speed main) Mode	LS (low- speed main) Mode	LV (low- voltage main) Mode	Unit	Para meter	Symbol	Conditions
Delay time from SCKp↓ to SOp output ^{Note 3}	t _{KSO2}	C = 30 pF ^{Note 4}	4.0 V ≤ EV _{DD} ≤ 5.5 V			2/f _{MCK} + 44		2/f _{MCK} + 110	ns
			2.7 V ≤ EV _{DD} < 4.0 V			2/f _{MCK} + 44		2/f _{MCK} + 110	ns
			2.4 V ≤ EV _{DD} < 2.7 V			2/f _{MCK} + 75		2/f _{MCK} + 110	ns
			1.8 V ≤ EV _{DD} < 2.4 V					2/f _{MCK} + 110	ns
			1.6 V ≤ EV _{DD} < 1.8 V						2/f _{MCK} + 220

- Notes**
1. When DAP_{mn} = 0 and CKP_{mn} = 0, or DAP_{mn} = 1 and CKP_{mn} = 1. The SIp setup time becomes “to SCKp↓” when DAP_{mn} = 0 and CKP_{mn} = 1, or DAP_{mn} = 1 and CKP_{mn} = 0.
 2. When DAP_{mn} = 0 and CKP_{mn} = 0, or DAP_{mn} = 1 and CKP_{mn} = 1. The SIp hold time becomes “from SCKp↓” when DAP_{mn} = 0 and CKP_{mn} = 1, or DAP_{mn} = 1 and CKP_{mn} = 0.
 3. When DAP_{mn} = 0 and CKP_{mn} = 0, or DAP_{mn} = 1 and CKP_{mn} = 1. The delay time to SOp output becomes “from SCKp↑” when DAP_{mn} = 0 and CKP_{mn} = 1, or DAP_{mn} = 1 and CKP_{mn} = 0.
 4. C is the load capacitance of the SCKp and SOp output lines.
 5. Transfer rate in the SNOOZE mode: MAX. 1 Mbps

Caution Select the normal input buffer for the SIp pin and SCKp pin and the normal output mode for the SOp pin by using port input mode register g (PIMg) and port output mode register g (POMg).

- Remarks**
1. p: CSI number (p = 00, 01), m: Unit number (m = 0),
n: Channel number (n = 0, 1), g: PIM number (g = 1)
 2. f_{MCK}: Serial array unit operation clock frequency
(Operation clock to be set by the serial clock select register m (SPSm) and the CKSmn bit of serial mode register mn (SMRmn). m: Unit number, n: Channel number (mn = 00, 01))

CSI mode connection diagram (during communication at same potential)

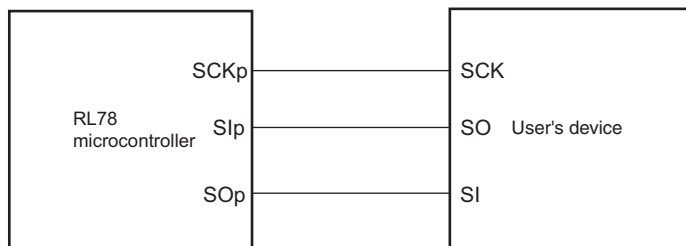

**CSI mode serial transfer timing (during communication at same potential)
(When DAPmn = 0 and CKPmn = 0, or DAPmn = 1 and CKPmn = 1.)**

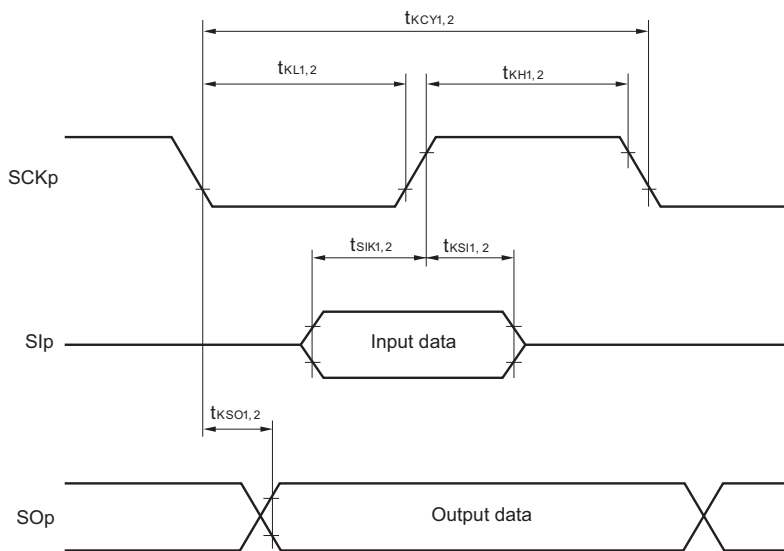

**CSI mode serial transfer timing (during communication at same potential)
(When DAPmn = 0 and CKPmn = 1, or DAPmn = 1 and CKPmn = 0.)**

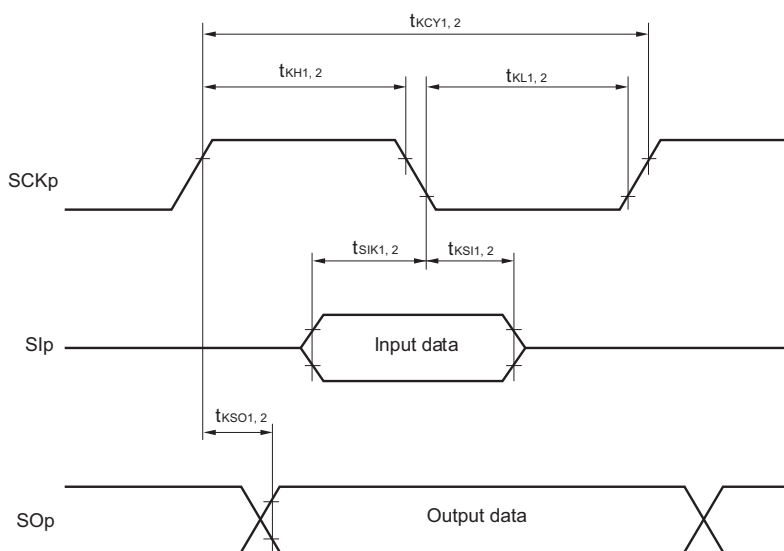

- Remarks 1. p: CSI number (p = 00, 01)
- 2. m: Unit number, n: Channel number (mn = 00, 01)

(4) Communication at different potential (1.8 V, 2.5 V, 3 V) (UART mode)

(1/2)

(T_A = -40 to +85°C, 1.8 V ≤ EV_{DD} = V_{DD} ≤ 5.5 V, V_{SS} = EV_{SS} = 0 V)

Parameter	Symbol	Conditions	HS (high-speed main) Mode		LS (low-speed main) Mode		LV (low-voltage main) Mode		Unit	
			MIN.	MAX.	MIN.	MAX.	MIN.	MAX.		
Transfer rate		Reception	4.0 V ≤ EV _{DD} ≤ 5.5 V, 2.7 V ≤ V _b ≤ 4.0 V		f _{MCK} /6 Note 1		f _{MCK} /6 Note 1		f _{MCK} /6 Note 1	bps
					Theoretical value of the maximum transfer rate f _{MCK} = f _{CLK} Note 3	4.0	1.3	0.6	Mbps	
			2.7 V ≤ EV _{DD} < 4.0 V, 2.3 V ≤ V _b ≤ 2.7 V		f _{MCK} /6 Note 1		f _{MCK} /6 Note 1		f _{MCK} /6 Note 1	bps
					Theoretical value of the maximum transfer rate f _{MCK} = f _{CLK} Note 3	4.0	1.3	0.6	Mbps	
			2.4 V ≤ EV _{DD} < 3.3 V, 1.6 V ≤ V _b ≤ 2.0 V		f _{MCK} /6 Note 1		f _{MCK} /6 Note 1		f _{MCK} /6 Note 1	bps
					Theoretical value of the maximum transfer rate f _{MCK} = f _{CLK} Note 3	4.0	1.3	0.6	Mbps	
			1.8 V ≤ EV _{DD} < 3.3 V, 1.6 V ≤ V _b ≤ 2.0 V				f _{MCK} /6 Notes 1, 2		f _{MCK} /6 Notes 1, 2	bps
							1.3	0.6	Mbps	

Notes 1. Transfer rate in the SNOOZE mode is 4800 bps only.**2.** Use it with EV_{DD} ≥ V_b.**3.** The maximum operating frequencies of the CPU/peripheral hardware clock (f_{CLK}) are:HS (high-speed main) mode: 24 MHz (2.7 V ≤ V_{DD} ≤ 5.5 V)16 MHz (2.4 V ≤ V_{DD} ≤ 5.5 V)LS (low-speed main) mode: 8 MHz (1.8 V ≤ V_{DD} ≤ 5.5 V)LV (low-voltage main) mode: 4 MHz (1.6 V ≤ V_{DD} ≤ 5.5 V)

Caution Select the TTL input buffer for the Rx_{Dq} pin and the N-ch open drain output (V_{DD} tolerance (32-pin to 52-pin products)/EV_{DD} tolerance (64-pin products)) mode for the Tx_{Dq} pin by using port input mode register g (PIMg) and port output mode register g (POMg). For V_{IH} and V_{IL}, see the DC characteristics with TTL input buffer selected.

Remarks 1. V_b[V]: Communication line voltage**2.** q: UART number (q = 0), g: PIM and POM number (g = 1)**3.** f_{MCK}: Serial array unit operation clock frequency

(Operation clock to be set by the serial clock select register m (SPSm) and the CKSmn bit of serial mode register mn (SMRmn). m: Unit number, n: Channel number (mn = 00, 01))

(4) Communication at different potential (1.8 V, 2.5 V, 3 V) (UART mode)

(2/2)

(T_A = -40 to +85°C, 1.8 V ≤ EV_{DD} = V_{DD} ≤ 5.5 V, V_{SS} = EV_{SS} = 0 V)

Parameter	Symbol	Conditions	HS (high-speed main) Mode		LS (low-speed main) Mode		LV (low-voltage main) Mode		Unit	
			MIN.	MAX.	MIN.	MAX.	MIN.	MAX.		
Transfer rate		Transmission	4.0 V ≤ EV _{DD} ≤ 5.5 V, 2.7 V ≤ V _b ≤ 4.0 V		Note 1		Note 1		Note 1	bps
			Theoretical value of the maximum transfer rate C _b = 50 pF, R _b = 1.4 kΩ, V _b = 2.7 V		2.8 ^{Note 2}		2.8 ^{Note 2}		2.8 ^{Note 2}	Mbps
			2.7 V ≤ EV _{DD} < 4.0 V, 2.3 V ≤ V _b ≤ 2.7 V		Note 3		Note 3		Note 3	bps
			Theoretical value of the maximum transfer rate C _b = 50 pF, R _b = 2.7 kΩ, V _b = 2.3 V		1.2 ^{Note 4}		1.2 ^{Note 4}		1.2 ^{Note 4}	Mbps
			2.4 V ≤ EV _{DD} < 3.3 V, 1.6 V ≤ V _b ≤ 2.0 V		Note 6		Note 6		Note 6	bps
			Theoretical value of the maximum transfer rate C _b = 50 pF, R _b = 5.5 kΩ, V _b = 1.6 V		0.43 ^{Note 7}		0.43 ^{Note 7}		0.43 ^{Note 7}	Mbps
			1.8 V ≤ EV _{DD} < 3.3 V, 1.6 V ≤ V _b ≤ 2.0 V				Notes 5, 6		Notes 5, 6	bps
			Theoretical value of the maximum transfer rate C _b = 50 pF, R _b = 5.5 kΩ, V _b = 1.6 V				0.43 ^{Note 7}		0.43 ^{Note 7}	Mbps

Notes 1. The smaller maximum transfer rate derived by using $f_{MCK}/6$ or the following expression is the valid maximum transfer rate.

Expression for calculating the transfer rate when 4.0 V ≤ EV_{DD} ≤ 5.5 V and 2.7 V ≤ V_b ≤ 4.0 V

$$\text{Maximum transfer rate} = \frac{1}{\{-C_b \times R_b \times \ln(1 - \frac{2.2}{V_b})\} \times 3} \text{ [bps]}$$

$$\text{Baud rate error (theoretical value)} = \frac{\frac{1}{\text{Transfer rate} \times 2} - \{-C_b \times R_b \times \ln(1 - \frac{2.2}{V_b})\}}{(\frac{1}{\text{Transfer rate}}) \times \text{Number of transferred bits}} \times 100 \text{ [%]}$$

* This value is the theoretical value of the relative difference between the transmission and reception sides.

- 2.** This value as an example is calculated when the conditions described in the "Conditions" column are met. Refer to Note 1 above to calculate the maximum transfer rate under conditions of the customer.

3. The smaller maximum transfer rate derived by using $f_{MCK}/6$ or the following expression is the valid maximum transfer rate.

Expression for calculating the transfer rate when $2.7\text{ V} \leq E_{VDD} < 4.0\text{ V}$ and $2.3\text{ V} \leq V_b \leq 2.7\text{ V}$

$$\text{Maximum transfer rate} = \frac{1}{\{-C_b \times R_b \times \ln(1 - \frac{2.0}{V_b})\} \times 3} \text{ [bps]}$$

$$\text{Baud rate error (theoretical value)} = \frac{\frac{1}{\text{Transfer rate} \times 2} - \{-C_b \times R_b \times \ln(1 - \frac{2.0}{V_b})\}}{(\frac{1}{\text{Transfer rate}}) \times \text{Number of transferred bits}} \times 100 \text{ [%]}$$

* This value is the theoretical value of the relative difference between the transmission and reception sides.

4. This value as an example is calculated when the conditions described in the “Conditions” column are met. Refer to Note 3 above to calculate the maximum transfer rate under conditions of the customer.
5. Use it with $E_{VDD} \geq V_b$.

6. The smaller maximum transfer rate derived by using $f_{MCK}/6$ or the following expression is the valid maximum transfer rate.

Expression for calculating the transfer rate when $1.8\text{ V} \leq E_{VDD} < 3.3\text{ V}$ and $1.6\text{ V} \leq V_b \leq 2.0\text{ V}$

$$\text{Maximum transfer rate} = \frac{1}{\{-C_b \times R_b \times \ln(1 - \frac{1.5}{V_b})\} \times 3} \text{ [bps]}$$

$$\text{Baud rate error (theoretical value)} = \frac{\frac{1}{\text{Transfer rate} \times 2} - \{-C_b \times R_b \times \ln(1 - \frac{1.5}{V_b})\}}{(\frac{1}{\text{Transfer rate}}) \times \text{Number of transferred bits}} \times 100 \text{ [%]}$$

* This value is the theoretical value of the relative difference between the transmission and reception sides.

7. This value as an example is calculated when the conditions described in the “Conditions” column are met. Refer to Note 6 above to calculate the maximum transfer rate under conditions of the customer.

Caution Select the TTL input buffer for the RxDq pin and the N-ch open drain output (V_{DD} tolerance (32-pin to 52-pin products)/ E_{VDD} tolerance (64-pin products)) mode for the TxDq pin by using port input mode register g (PIMg) and port output mode register g (POMg). For V_{IH} and V_{IL} , see the DC characteristics with TTL input buffer selected.

UART mode connection diagram (during communication at different potential)

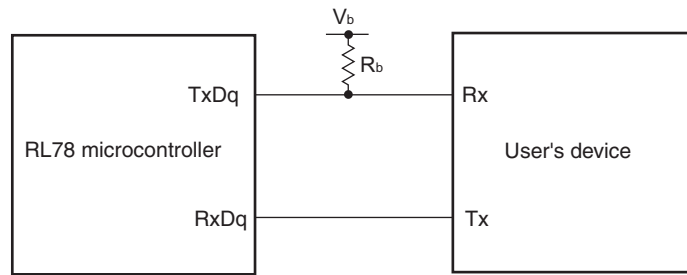

UART mode bit width (during communication at different potential) (reference)

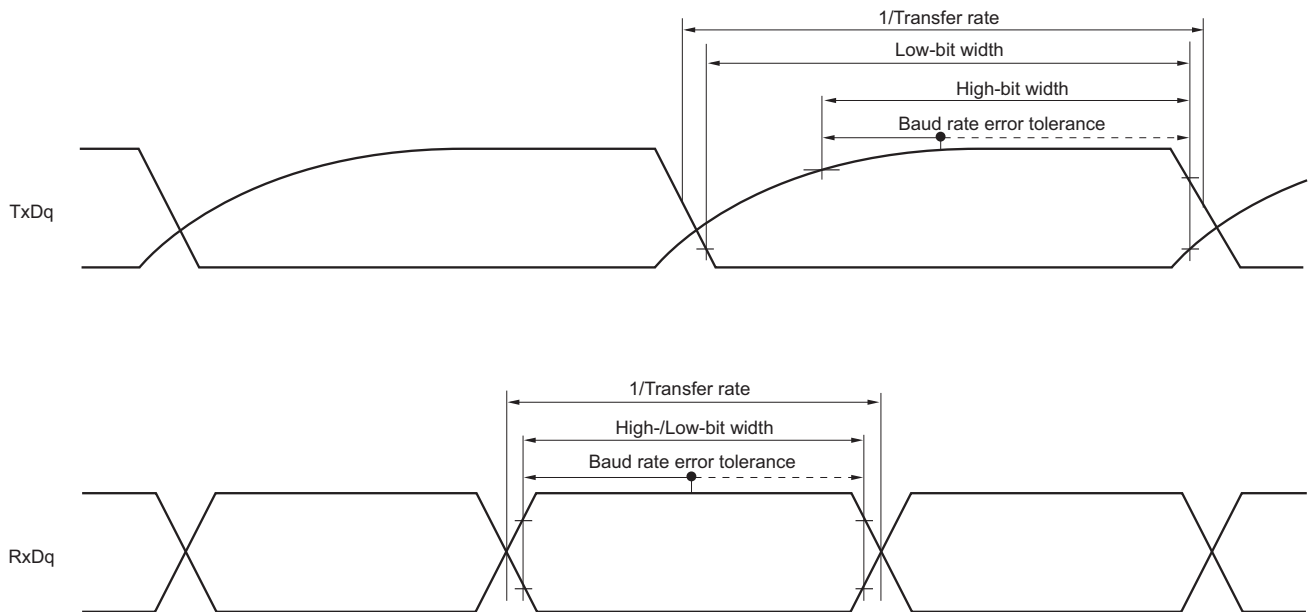

- Remarks 1.** $R_b[\Omega]$: Communication line (TxDq) pull-up resistance,
 $C_b[F]$: Communication line (TxDq) load capacitance, $V_b[V]$: Communication line voltage
- 2.** q: UART number (q = 0, 1), g: PIM and POM number (g = 1)
- 3.** f_{mck} : Serial array unit operation clock frequency
 (Operation clock to be set by the serial clock select register m (SPSm) and the CKSmn bit of serial mode register mn (SMRmn). m: Unit number, n: Channel number (mn = 00, 01))

(5) Communication at different potential (2.5 V, 3 V) (CSI mode) (master mode, SCKp... internal clock output, corresponding CSI00 only)**(T_A = -40 to +85°C, 2.7 V ≤ EV_{DD} = V_{DD} ≤ 5.5 V, V_{SS} = EV_{SS} = 0 V)**

Parameter	Symbol	Conditions	HS (high-speed main) Mode		LS (low-speed main) Mode		LV (low-voltage main) Mode		Unit
			MIN.	MAX.	MIN.	MAX.	MIN.	MAX.	
SCKp cycle time	t _{KCY1}	t _{KCY1} ≥ 2/f _{CLK} 4.0 V ≤ EV _{DD} ≤ 5.5 V, 2.7 V ≤ V _b ≤ 4.0 V, C _b = 20 pF, R _b = 1.4 kΩ	200 Note 1		1150 Note 1		1150 Note 1		ns
			300 Note 1		1150 Note 1		1150 Note 1		ns
SCKp high-level width	t _{KH1}	4.0 V ≤ EV _{DD} ≤ 5.5 V, 2.7 V ≤ V _b ≤ 4.0 V, C _b = 20 pF, R _b = 1.4 kΩ	t _{KCY1} /2 - 50		t _{KCY1} /2 - 50		t _{KCY1} /2 - 50		ns
		2.7 V ≤ EV _{DD} < 4.0 V, 2.3 V ≤ V _b ≤ 2.7 V, C _b = 20 pF, R _b = 2.7 kΩ	t _{KCY1} /2 - 120		t _{KCY1} /2 - 120		t _{KCY1} /2 - 120		ns
SCKp low-level width	t _{KL1}	4.0 V ≤ EV _{DD} ≤ 5.5 V, 2.7 V ≤ V _b ≤ 4.0 V, C _b = 20 pF, R _b = 1.4 kΩ	t _{KCY1} /2 - 7		t _{KCY1} /2 - 50		t _{KCY1} /2 - 50		ns
		2.7 V ≤ EV _{DD} < 4.0 V, 2.3 V ≤ V _b ≤ 2.7 V, C _b = 20 pF, R _b = 2.7 kΩ	t _{KCY1} /2 - 10		t _{KCY1} /2 - 50		t _{KCY1} /2 - 50		ns
Slp setup time (to SCKp↑) ^{Note 2}	t _{SIK1}	4.0 V ≤ EV _{DD} ≤ 5.5 V, 2.7 V ≤ V _b ≤ 4.0 V, C _b = 20 pF, R _b = 1.4 kΩ	58		479		479		ns
		2.7 V ≤ EV _{DD} < 4.0 V, 2.3 V ≤ V _b ≤ 2.7 V, C _b = 20 pF, R _b = 2.7 kΩ	121		479		479		ns
Slp hold time (from SCKp↑) ^{Note 2}	t _{KSH1}	4.0 V ≤ EV _{DD} ≤ 5.5 V, 2.7 V ≤ V _b ≤ 4.0 V, C _b = 20 pF, R _b = 1.4 kΩ	10		10		10		ns
		2.7 V ≤ EV _{DD} < 4.0 V, 2.3 V ≤ V _b ≤ 2.7 V, C _b = 20 pF, R _b = 2.7 kΩ	10		10		10		ns
Delay time from SCKp↓ to SOp output ^{Note 2}	t _{KSO1}	4.0 V ≤ EV _{DD} ≤ 5.5 V, 2.7 V ≤ V _b ≤ 4.0 V, C _b = 20 pF, R _b = 1.4 kΩ		60		60		60	ns
		2.7 V ≤ EV _{DD} < 4.0 V, 2.3 V ≤ V _b ≤ 2.7 V, C _b = 20 pF, R _b = 2.7 kΩ		130		130		130	ns
Slp setup time (to SCKp↓) ^{Note 3}	t _{SIK1}	4.0 V ≤ EV _{DD} ≤ 5.5 V, 2.7 V ≤ V _b ≤ 4.0 V, C _b = 20 pF, R _b = 1.4 kΩ	23		110		110		ns
		2.7 V ≤ EV _{DD} < 4.0 V, 2.3 V ≤ V _b ≤ 2.7 V, C _b = 20 pF, R _b = 2.7 kΩ	33		110		110		ns
Slp hold time (from SCKp↓) ^{Note 3}	t _{KSH1}	4.0 V ≤ EV _{DD} ≤ 5.5 V, 2.7 V ≤ V _b ≤ 4.0 V, C _b = 20 pF, R _b = 1.4 kΩ	10		10		10		ns
		2.7 V ≤ EV _{DD} < 4.0 V, 2.3 V ≤ V _b ≤ 2.7 V, C _b = 20 pF, R _b = 2.7 kΩ	10		10		10		ns
Delay time from SCKp↑ to SOp output ^{Note 3}	t _{KSO1}	4.0 V ≤ EV _{DD} ≤ 5.5 V, 2.7 V ≤ V _b ≤ 4.0 V, C _b = 20 pF, R _b = 1.4 kΩ		10		10		10	ns
		2.7 V ≤ EV _{DD} < 4.0 V, 2.3 V ≤ V _b ≤ 2.7 V, C _b = 20 pF, R _b = 2.7 kΩ		10		10		10	ns

(Notes, Caution and Remarks are listed on the next page.)

- Notes**
1. For CSI00, set a cycle of $2/f_{MCK}$ or longer. For CSI01, set a cycle of $4/f_{MCK}$ or longer.
 2. When DAP_{mn} = 0 and CKP_{mn} = 0, or DAP_{mn} = 1 and CKP_{mn} = 1.
 3. When DAP_{mn} = 0 and CKP_{mn} = 1, or DAP_{mn} = 1 and CKP_{mn} = 0.

Caution Select the TTL input buffer for the SIp pin and the N-ch open drain output (V_{DD} tolerance (32-pin to 52-pin products)/EV_{DD} tolerance (64-pin products)) mode for the SOp pin and SCKp pin by using port input mode register g (PIMg) and port output mode register g (POMg). For V_{IH} and V_{IL}, see the DC characteristics with TTL input buffer selected.

- Remarks**
1. R_b[Ω]: Communication line (SCKp, SOp) pull-up resistance, C_b[F]: Communication line (SCKp, SOp) load capacitance, V_b[V]: Communication line voltage
 2. p: CSI number (p = 00, 01), m: Unit number (m = 0), n: Channel number (n = 0, 1),
g: PIM and POM number (g = 1)
 3. f_{MCK}: Serial array unit operation clock frequency
(Operation clock to be set by the serial clock select register m (SPSm) and the CKSmn bit of serial mode register mn (SMRmn). m: Unit number, n: Channel number (mn = 00, 01))

(6) Communication at different potential (1.8 V, 2.5 V, 3 V) (CSI mode) (master mode, SCKp... internal clock output) (1/3)
(T_A = -40 to +85°C, 1.8 V ≤ EV_{DD} = V_{DD} ≤ 5.5 V, V_{SS} = EV_{SS} = 0 V)

Parameter	Symbol	Conditions	HS (high-speed main) Mode		LS (low-speed main) Mode		LV (low-voltage main) Mode		Unit
			MIN.	MAX.	MIN.	MAX.	MIN.	MAX.	
SCKp cycle time	t _{KCY1}	t _{KCY1} ≥ 4/f _{CLK} 4.0 V ≤ EV _{DD} ≤ 5.5 V, 2.7 V ≤ V _b ≤ 4.0 V, C _b = 30 pF, R _b = 1.4 kΩ	300		1150		1150		ns
			500		1150		1150		ns
			1150		1150		1150		ns
					1150		1150		ns
SCKp high-level width	t _{KH1}	4.0 V ≤ EV _{DD} ≤ 5.5 V, 2.7 V ≤ V _b ≤ 4.0 V, C _b = 30 pF, R _b = 1.4 kΩ	t _{KCY1} /2		t _{KCY1} /2		t _{KCY1} /2		ns
			- 75		- 75		- 75		ns
			t _{KCY1} /2		t _{KCY1} /2		t _{KCY1} /2		ns
			- 170		- 170		- 170		ns
SCKp high-level width	t _{KH1}	2.7 V ≤ EV _{DD} < 4.0 V, 2.3 V ≤ V _b ≤ 2.7 V, C _b = 30 pF, R _b = 2.7 kΩ	t _{KCY1} /2		t _{KCY1} /2		t _{KCY1} /2		ns
			- 170		- 170		- 170		ns
			t _{KCY1} /2		t _{KCY1} /2		t _{KCY1} /2		ns
			- 458		- 458		- 458		ns
SCKp high-level width	t _{KH1}	2.4 V ≤ EV _{DD} < 3.3 V, 1.6 V ≤ V _b ≤ 2.0 V, C _b = 30 pF, R _b = 5.5 kΩ	t _{KCY1} /2		t _{KCY1} /2		t _{KCY1} /2		ns
			- 458		- 458		- 458		ns
			t _{KCY1} /2		t _{KCY1} /2		t _{KCY1} /2		ns
			- 458		- 458		- 458		ns
SCKp high-level width	t _{KH1}	1.8 V ≤ EV _{DD} < 3.3 V, 1.6 V ≤ V _b ≤ 2.0 V ^{Note} , C _b = 30 pF, R _b = 5.5 kΩ	t _{KCY1} /2		t _{KCY1} /2		t _{KCY1} /2		ns
			- 458		- 458		- 458		ns
			t _{KCY1} /2		t _{KCY1} /2		t _{KCY1} /2		ns
			- 458		- 458		- 458		ns
SCKp low-level width	t _{KL1}	4.0 V ≤ EV _{DD} ≤ 5.5 V, 2.7 V ≤ V _b ≤ 4.0 V, C _b = 30 pF, R _b = 1.4 kΩ	t _{KCY1} /2		t _{KCY1} /2		t _{KCY1} /2		ns
			- 12		- 50		- 50		ns
			t _{KCY1} /2		t _{KCY1} /2		t _{KCY1} /2		ns
			- 18		- 50		- 50		ns
SCKp low-level width	t _{KL1}	2.7 V ≤ EV _{DD} < 4.0 V, 2.3 V ≤ V _b ≤ 2.7 V, C _b = 30 pF, R _b = 2.7 kΩ	t _{KCY1} /2		t _{KCY1} /2		t _{KCY1} /2		ns
			- 18		- 50		- 50		ns
			t _{KCY1} /2		t _{KCY1} /2		t _{KCY1} /2		ns
			- 50		- 50		- 50		ns
SCKp low-level width	t _{KL1}	2.4 V ≤ EV _{DD} < 3.3 V, 1.6 V ≤ V _b ≤ 2.0 V, C _b = 30 pF, R _b = 5.5 kΩ	t _{KCY1} /2		t _{KCY1} /2		t _{KCY1} /2		ns
			- 50		- 50		- 50		ns
			t _{KCY1} /2		t _{KCY1} /2		t _{KCY1} /2		ns
			- 50		- 50		- 50		ns
SCKp low-level width	t _{KL1}	1.8 V ≤ EV _{DD} < 3.3 V, 1.6 V ≤ V _b ≤ 2.0 V ^{Note} , C _b = 30 pF, R _b = 5.5 kΩ	t _{KCY1} /2		t _{KCY1} /2		t _{KCY1} /2		ns
			- 50		- 50		- 50		ns
			t _{KCY1} /2		t _{KCY1} /2		t _{KCY1} /2		ns
			- 50		- 50		- 50		ns

Note Use it with EV_{DD} ≥ V_b.

Caution Select the TTL input buffer for the SIp pin and the N-ch open drain output (V_{DD} tolerance (32-pin to 52-pin products)/EV_{DD} tolerance (64-pin products)) mode for the SOp pin and SCKp pin by using port input mode register g (PIMg) and port output mode register g (POMg). For V_{IH} and V_{IL}, see the DC characteristics with TTL input buffer selected.

(6) Communication at different potential (1.8 V, 2.5 V, 3 V) (CSI mode) (master mode, SCKp... internal clock output) (2/3)
(T_A = -40 to +85°C, 1.8 V ≤ EV_{DD} = V_{DD} ≤ 5.5 V, V_{SS} = EV_{SS} = 0 V)

Parameter	Symbol	Conditions	HS (high-speed main) Mode		LS (low-speed main) Mode		LV (low-voltage main) Mode		Unit
			MIN.	MAX.	MIN.	MAX.	MIN.	MAX.	
Slp setup time (to SCKp↑) ^{Note 1}	tsIK1	4.0 V ≤ EV _{DD} ≤ 5.5 V, 2.7 V ≤ V _b ≤ 4.0 V, C _b = 30 pF, R _b = 1.4 kΩ	81		479		479		ns
		2.7 V ≤ EV _{DD} < 4.0 V, 2.3 V ≤ V _b ≤ 2.7 V, C _b = 30 pF, R _b = 2.7 kΩ	177		479		479		ns
		2.4 V ≤ EV _{DD} < 3.3 V, 1.6 V ≤ V _b ≤ 2.0 V, C _b = 30 pF, R _b = 5.5 kΩ	479		479		479		ns
		1.8 V ≤ EV _{DD} < 3.3 V, 1.6 V ≤ V _b ≤ 2.0 V ^{Note 3} , C _b = 30 pF, R _b = 5.5 kΩ			479		479		ns
Slp hold time (from SCKp↑) ^{Note 1}	tkSI1	4.0 V ≤ EV _{DD} ≤ 5.5 V, 2.7 V ≤ V _b ≤ 4.0 V, C _b = 30 pF, R _b = 1.4 kΩ	19		19		19		ns
		2.7 V ≤ EV _{DD} < 4.0 V, 2.3 V ≤ V _b ≤ 2.7 V, C _b = 30 pF, R _b = 2.7 kΩ	19		19		19		ns
		2.4 V ≤ EV _{DD} < 3.3 V, 1.6 V ≤ V _b ≤ 2.0 V, C _b = 30 pF, R _b = 5.5 kΩ	19		19		19		ns
		1.8 V ≤ EV _{DD} < 3.3 V, 1.6 V ≤ V _b ≤ 2.0 V ^{Note 3} , C _b = 30 pF, R _b = 5.5 kΩ			19		19		ns
Delay time from SCKp↓ to SOP output ^{Note 1}	tkSO1	4.0 V ≤ EV _{DD} ≤ 5.5 V, 2.7 V ≤ V _b ≤ 4.0 V, C _b = 30 pF, R _b = 1.4 kΩ		100		100		100	ns
		2.7 V ≤ EV _{DD} < 4.0 V, 2.3 V ≤ V _b ≤ 2.7 V, C _b = 30 pF, R _b = 2.7 kΩ		195		195		195	ns
		2.4 V ≤ EV _{DD} < 4.0 V, 2.3 V ≤ V _b ≤ 2.7 V, C _b = 30 pF, R _b = 2.7 kΩ		483		483		483	ns
		1.8 V ≤ EV _{DD} < 3.3 V, 1.6 V ≤ V _b ≤ 2.0 V ^{Note 3} , C _b = 30 pF, R _b = 5.5 kΩ				483		483	ns
Slp setup time (to SCKp↓) ^{Note 2}	tsIK1	4.0 V ≤ EV _{DD} ≤ 5.5 V, 2.7 V ≤ V _b ≤ 4.0 V, C _b = 30 pF, R _b = 1.4 kΩ	44		110		110		ns
		2.7 V ≤ EV _{DD} < 4.0 V, 2.3 V ≤ V _b ≤ 2.7 V, C _b = 30 pF, R _b = 2.7 kΩ	44		110		110		ns
		2.4 V ≤ EV _{DD} < 4.0 V, 2.3 V ≤ V _b ≤ 2.7 V, C _b = 30 pF, R _b = 2.7 kΩ	110		110		110		ns
		1.8 V ≤ EV _{DD} < 3.3 V, 1.6 V ≤ V _b ≤ 2.0 V ^{Note 3} , C _b = 30 pF, R _b = 5.5 kΩ			110		110		ns

- Notes**
1. When DAPmn = 0 and CKPmn = 0, or DAPmn = 1 and CKPmn = 1.
 2. When DAPmn = 0 and CKPmn = 1, or DAPmn = 1 and CKPmn = 0.
 3. Use it with EV_{DD} ≥ V_b.

Caution Select the TTL input buffer for the Slp pin and the N-ch open drain output (V_{DD} tolerance (32-pin to 52-pin products)/EV_{DD} tolerance (64-pin products)) mode for the SOP pin and SCKp pin by using port input mode register g (PIMg) and port output mode register g (POMg). For V_{IH} and V_{IL}, see the DC characteristics with TTL input buffer selected.

(6) Communication at different potential (1.8 V, 2.5 V, 3 V) (CSI mode) (master mode, SCKp... internal clock output) (3/3)
(T_A = -40 to +85°C, 1.8 V ≤ EV_{DD} = V_{DD} ≤ 5.5 V, V_{SS} = EV_{SS} = 0 V)

Parameter	Symbol	Conditions	HS (high-speed main) Mode		LS (low-speed main) Mode		LV (low-voltage main) Mode		Unit
			MIN.	MAX.	MIN.	MAX.	MIN.	MAX.	
Slp hold time (from SCKp↓) ^{Note 2}	t _{KSI1}	4.0 V ≤ EV _{DD} ≤ 5.5 V, 2.7 V ≤ V _b ≤ 4.0 V, C _b = 30 pF, R _b = 1.4 kΩ	19		19		19		ns
		2.7 V ≤ EV _{DD} < 4.0 V, 2.3 V ≤ V _b ≤ 2.7 V, C _b = 30 pF, R _b = 2.7 kΩ	19		19		19		ns
		2.4 V ≤ EV _{DD} < 3.3 V, 1.6 V ≤ V _b ≤ 2.0 V, C _b = 30 pF, R _b = 5.5 kΩ	19		19		19		ns
		1.8 V ≤ EV _{DD} < 3.3 V, 1.6 V ≤ V _b ≤ 2.0 V ^{Note 3} , C _b = 30 pF, R _b = 5.5 kΩ			19		19		ns
Delay time from SCKp↑ to SOp output ^{Note 2}	t _{KSO1}	4.0 V ≤ EV _{DD} ≤ 5.5 V, 2.7 V ≤ V _b ≤ 4.0 V, C _b = 30 pF, R _b = 1.4 kΩ		25		25		25	ns
		2.7 V ≤ EV _{DD} < 4.0 V, 2.3 V ≤ V _b ≤ 2.7 V, C _b = 30 pF, R _b = 2.7 kΩ		25		25		25	ns
		2.4 V ≤ EV _{DD} < 3.3 V, 1.6 V ≤ V _b ≤ 2.0 V, C _b = 30 pF, R _b = 5.5 kΩ		25		25		25	ns
		1.8 V ≤ EV _{DD} < 3.3 V, 1.6 V ≤ V _b ≤ 2.0 V ^{Note 3} , C _b = 30 pF, R _b = 5.5 kΩ				25		25	ns

- Notes**
1. When DAPmn = 0 and CKPmn = 0, or DAPmn = 1 and CKPmn = 1.
 2. When DAPmn = 0 and CKPmn = 1, or DAPmn = 1 and CKPmn = 0.
 3. Use it with EV_{DD} ≥ V_b.

Caution Select the TTL input buffer for the Slp pin and the N-ch open drain output (V_{DD} tolerance (32-pin to 52-pin products)/EV_{DD} tolerance (64-pin products)) mode for the SOp pin and SCKp pin by using port input mode register g (PIMg) and port output mode register g (POMg). For V_{IH} and V_{IL}, see the DC characteristics with TTL input buffer selected.

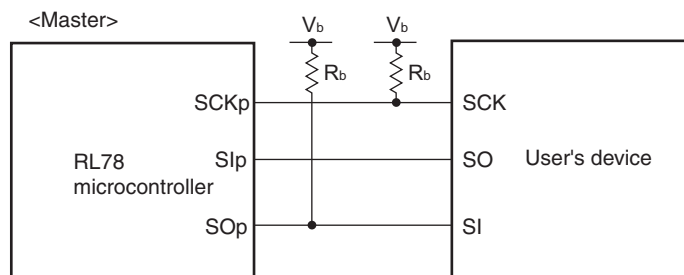
CSI mode connection diagram (during communication at different potential)

- Remarks**
1. $R_b[\Omega]$: Communication line (SCKp, SOp) pull-up resistance, $C_b[F]$: Communication line (SCKp, SOp) load capacitance, $V_b[V]$: Communication line voltage
 2. p: CSI number (p = 00, 01), m: Unit number (m = 0), n: Channel number (n = 0, 1), g: PIM and POM number (g = 1)
 3. f_{MCK} : Serial array unit operation clock frequency
(Operation clock to be set by the serial clock select register m (SPSm) and the CKSmn bit of serial mode register mn (SMRmn). m: Unit number, n: Channel number (mn = 00, 01))

**CSI mode serial transfer timing (master mode) (during communication at different potential)
(When DAPmn = 0 and CKPmn = 0, or DAPmn = 1 and CKPmn = 1.)**

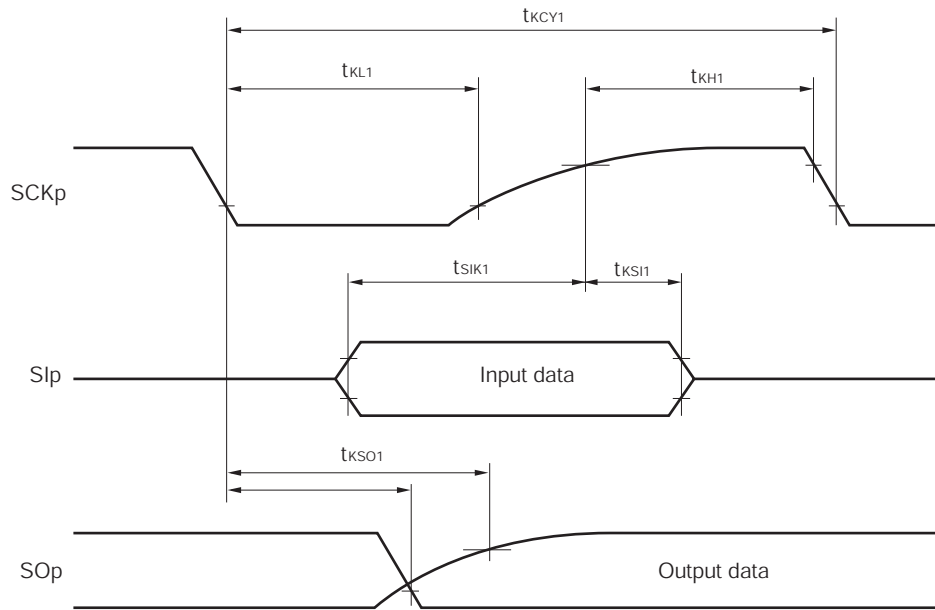

**CSI mode serial transfer timing (master mode) (during communication at different potential)
(When DAPmn = 0 and CKPmn = 1, or DAPmn = 1 and CKPmn = 0.)**

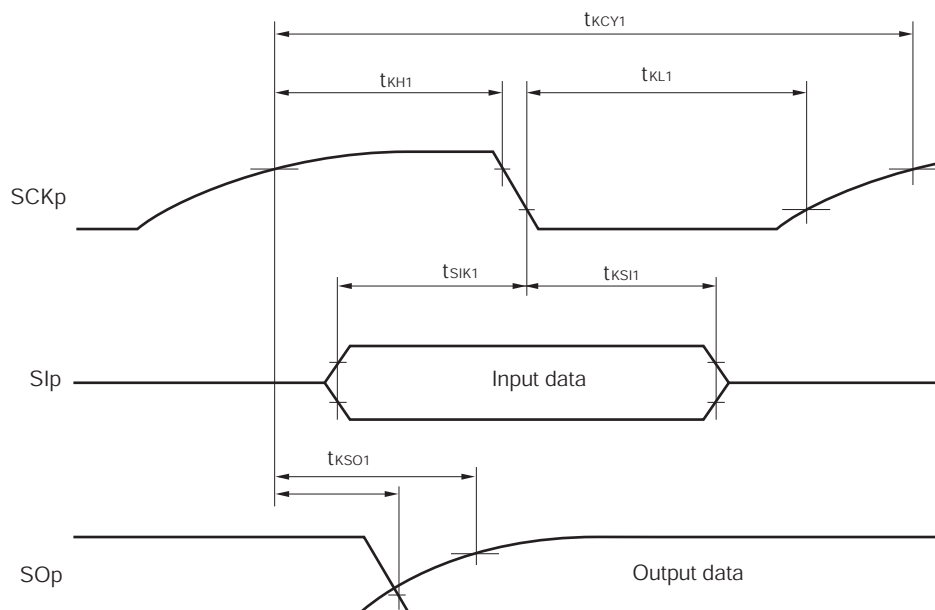

Remark p: CSI number (p = 00, 01), m: Unit number (m = 0), n: Channel number (n = 0, 1),
g: PIM and POM number (g = 1)

(7) Communication at different potential (1.8 V, 2.5 V, 3 V) (CSI mode) (slave mode, SCKp... external clock input)
(T_A = -40 to +85°C, 1.8 V ≤ EV_{DD} = V_{DD} ≤ 5.5 V, V_{SS} = EV_{SS} = 0 V) **(1/2)**

Parameter	Symbol	Conditions		HS (high-speed main) mode		LS (low-speed main) mode		LV (low-voltage main) mode		Unit	
				MIN.	MAX.	MIN.	MAX.	MIN.	MAX.		
SCKp cycle time ^{Note 1}	t _{KCY2}	4.0 V ≤ EV _{DD} ≤ 5.5 V, 2.7 V ≤ V _b ≤ 4.0 V	20 MHz < f _{MCK} ≤ 24 MHz	12/f _{MCK}						ns	
			8 MHz < f _{MCK} ≤ 20 MHz	10/f _{MCK}						ns	
			4 MHz < f _{MCK} ≤ 8 MHz	8/f _{MCK}		16/f _{MCK}				ns	
			f _{MCK} ≤ 4 MHz	6/f _{MCK}		10/f _{MCK}		10/f _{MCK}		ns	
		2.7 V ≤ EV _{DD} < 4.0 V, 2.3 V ≤ V _b ≤ 2.7 V	20 MHz < f _{MCK} ≤ 24 MHz	16/f _{MCK}						ns	
			16 MHz < f _{MCK} ≤ 20 MHz	14/f _{MCK}						ns	
			8 MHz < f _{MCK} ≤ 16 MHz	12/f _{MCK}						ns	
			4 MHz < f _{MCK} ≤ 8 MHz	8/f _{MCK}		16/f _{MCK}				ns	
		2.4 V ≤ EV _{DD} < 3.3 V, 1.6 V ≤ V _b ≤ 2.0 V	20 MHz < f _{MCK} ≤ 24 MHz	36/f _{MCK}						ns	
			16 MHz < f _{MCK} ≤ 20 MHz	32/f _{MCK}						ns	
			8 MHz < f _{MCK} ≤ 16 MHz	26/f _{MCK}						ns	
			4 MHz < f _{MCK} ≤ 8 MHz	16/f _{MCK}		16/f _{MCK}				ns	
		1.8 V ≤ EV _{DD} < 3.3 V, 1.6 V ≤ V _b ≤ 2.0 V ^{Note 2}	f _{MCK} ≤ 4 MHz	10/f _{MCK}		10/f _{MCK}		10/f _{MCK}		ns	
			4 MHz < f _{MCK} ≤ 8 MHz			16/f _{MCK}				ns	
		SCKp high-/low-level width	t _{KH2} , t _{KL2}	4.0 V ≤ EV _{DD} ≤ 5.5 V, 2.7 V ≤ V _b ≤ 4.0 V	t _{KCY2} /2 - 12		t _{KCY2} /2 - 50		t _{KCY2} /2 - 50		ns
				2.7 V ≤ EV _{DD} < 4.0 V, 2.3 V ≤ V _b ≤ 2.7 V	t _{KCY2} /2 - 18		t _{KCY2} /2 - 50		t _{KCY2} /2 - 50		ns
2.4 V ≤ EV _{DD} < 3.3 V, 1.6 V ≤ V _b ≤ 2.0 V	t _{KCY2} /2 - 50				t _{KCY2} /2 - 50		t _{KCY2} /2 - 50		ns		
1.8 V ≤ EV _{DD} < 3.3 V, 1.6 V ≤ V _b ≤ 2.0 V ^{Note 2}					t _{KCY2} /2 - 50		t _{KCY2} /2 - 50		ns		
Slp setup time (to SCKp↑) ^{Note 3}	t _{SIK2}	4.0 V ≤ EV _{DD} < 5.5 V, 2.7 V ≤ V _b ≤ 4.0 V	1/f _{MCK} + 20		1/f _{MCK} + 30		1/f _{MCK} + 30		ns		
		2.7 V ≤ EV _{DD} < 4.0 V, 2.3 V ≤ V _b ≤ 2.7 V	1/f _{MCK} + 20		1/f _{MCK} + 30		1/f _{MCK} + 30		ns		
		2.4 V ≤ EV _{DD} < 3.3 V, 1.6 V ≤ V _b ≤ 2.0 V	1/f _{MCK} + 30		1/f _{MCK} + 30		1/f _{MCK} + 30		ns		
		1.8 V ≤ EV _{DD} < 3.3 V, 1.6 V ≤ V _b ≤ 2.0 V ^{Note 2}			1/f _{MCK} + 30		1/f _{MCK} + 30		ns		
Slp hold time (from SCKp↑) ^{Note 4}	t _{KSI2}	4.0 V ≤ EV _{DD} < 5.5 V, 2.7 V ≤ V _b ≤ 4.0 V	1/f _{MCK} + 31		1/f _{MCK} + 31		1/f _{MCK} + 31		ns		
		2.7 V ≤ EV _{DD} < 4.0 V, 2.3 V ≤ V _b ≤ 2.7 V	1/f _{MCK} + 31		1/f _{MCK} + 31		1/f _{MCK} + 31		ns		
		2.4 V ≤ EV _{DD} < 3.3 V, 1.6 V ≤ V _b ≤ 2.0 V	1/f _{MCK} + 31		1/f _{MCK} + 31		1/f _{MCK} + 31		ns		
		1.8 V ≤ EV _{DD} < 3.3 V, 1.6 V ≤ V _b ≤ 2.0 V ^{Note 2}			1/f _{MCK} + 31		1/f _{MCK} + 31		ns		

(Notes, Caution and Remarks are listed on the next page.)

(7) Communication at different potential (1.8 V, 2.5 V, 3 V) (CSI mode) (slave mode, SCKp... external clock input)
(T_A = -40 to +85°C, 1.8 V ≤ EV_{DD} = V_{DD} ≤ 5.5 V, V_{SS} = EV_{SS} = 0 V) **(2/2)**

Parameter	Symbol	Conditions	HS (high-speed main) mode		LS (low-speed main) mode		LV (low-voltage main) mode		Unit
			MIN.	MAX.	MIN.	MAX.	MIN.	MAX.	
Delay time from SCKp↓ to SOp output ^{Note 5}	t _{KS02}	4.0 V ≤ EV _{DD} ≤ 5.5 V, 2.7 V ≤ V _b ≤ 4.0 V, C _b = 30 pF, R _b = 1.4 kΩ		2/f _{MCK} + 120		2/f _{MCK} + 573		2/f _{MCK} + 573	ns
		2.7 V ≤ EV _{DD} < 4.0 V, 2.3 V ≤ V _b ≤ 2.7 V, C _b = 30 pF, R _b = 2.7 kΩ		2/f _{MCK} + 214		2/f _{MCK} + 573		2/f _{MCK} + 573	ns
		2.4 V ≤ EV _{DD} < 3.3 V, 1.6 V ≤ V _b ≤ 2.0 V, C _b = 30 pF, R _b = 5.5 kΩ		2/f _{MCK} + 573		2/f _{MCK} + 573		2/f _{MCK} + 573	ns
		1.8 V ≤ EV _{DD} < 3.3 V, 1.6 V ≤ V _b ≤ 2.0 V ^{Note 2} , C _b = 30 pF, R _b = 5.5 kΩ				2/f _{MCK} + 573		2/f _{MCK} + 573	ns

- Notes 1.** Transfer rate in the SNOOZE mode : MAX. 1 Mbps
- Use it with EV_{DD} ≥ V_b.
 - When DAP_{mn} = 0 and CKP_{mn} = 0, or DAP_{mn} = 1 and CKP_{mn} = 1. The SIp setup time becomes “to SCKp↓” when DAP_{mn} = 0 and CKP_{mn} = 1, or DAP_{mn} = 1 and CKP_{mn} = 0.
 - When DAP_{mn} = 0 and CKP_{mn} = 0, or DAP_{mn} = 1 and CKP_{mn} = 1. The SIp hold time becomes “from SCKp↓” when DAP_{mn} = 0 and CKP_{mn} = 1, or DAP_{mn} = 1 and CKP_{mn} = 0.
 - When DAP_{mn} = 0 and CKP_{mn} = 0, or DAP_{mn} = 1 and CKP_{mn} = 1. The delay time to SOp output becomes “from SCKp↑” when DAP_{mn} = 0 and CKP_{mn} = 1, or DAP_{mn} = 1 and CKP_{mn} = 0.

Caution Select the TTL input buffer for the SIp pin and SCKp pin and the N-ch open drain output (V_{DD} tolerance (32-pin to 52-pin products)/EV_{DD} tolerance (64-pin products)) mode for the SOp pin by using port input mode register g (PIMg) and port output mode register g (POMg). For V_{IH} and V_{IL}, see the DC characteristics with TTL input buffer selected.

CSI mode connection diagram (during communication at different potential)

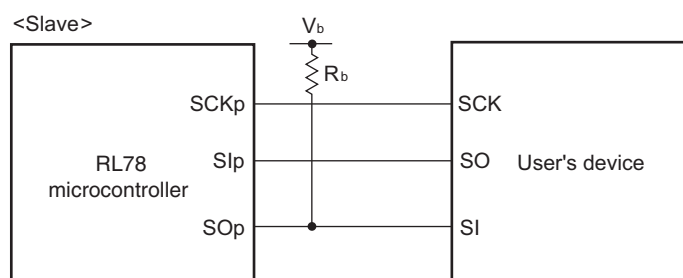

- Remarks 1.** R_b[Ω]: Communication line (SO_p) pull-up resistance, C_b[F]: Communication line (SO_p) load capacitance, V_b[V]: Communication line voltage
- p: CSI number (p = 00, 01), m: Unit number (m = 0), n: Channel number (n = 0, 1), g: PIM and POM number (g = 1)
 - f_{MCK}: Serial array unit operation clock frequency
 (Operation clock to be set by the serial clock select register m (SPSm) and the CKSmn bit of serial mode register mn (SMRmn). m: Unit number, n: Channel number (mn = 00, 01))

CSI mode serial transfer timing (slave mode) (during communication at different potential)
(When DAPmn = 0 and CKPmn = 0, or DAPmn = 1 and CKPmn = 1.)

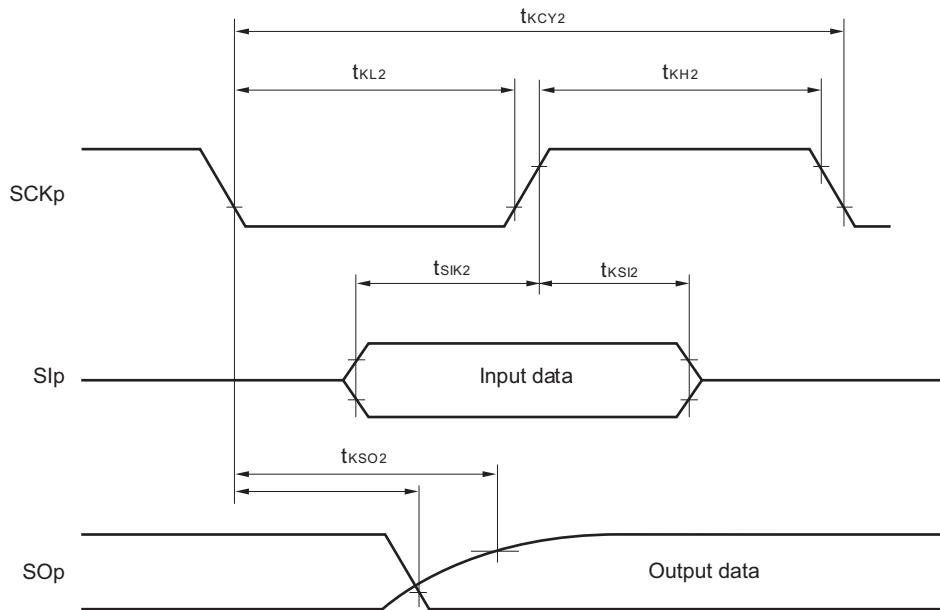

CSI mode serial transfer timing (slave mode) (during communication at different potential)
(When DAPmn = 0 and CKPmn = 1, or DAPmn = 1 and CKPmn = 0.)

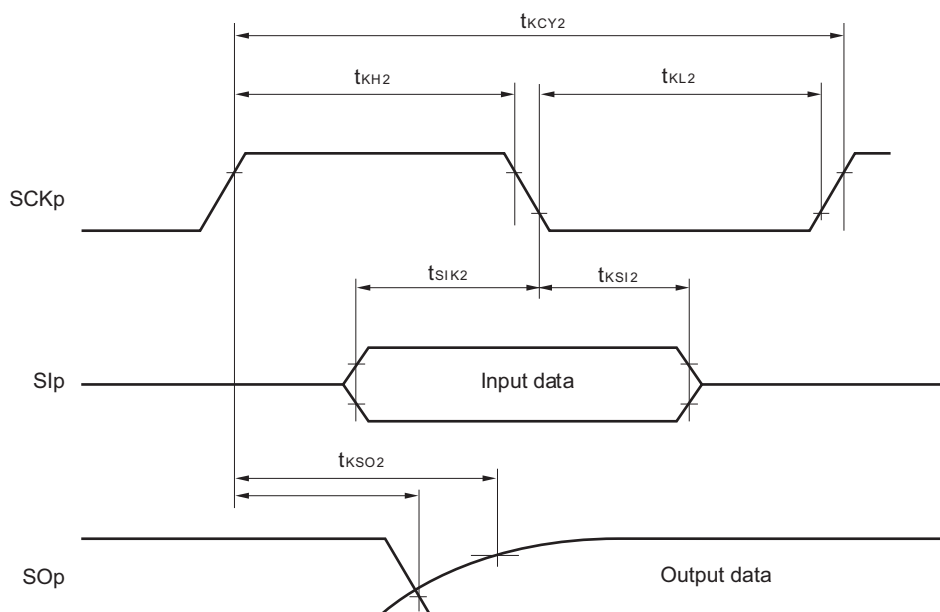

Remark p: CSI number (p = 00, 01), m: Unit number (m = 0), n: Channel number (n = 0, 1),
g: PIM and POM number (g = 1)

2.5.2 Serial interface IICA

(1) I²C standard mode(T_A = -40 to +85°C, 1.6 V ≤ EV_{DD} = V_{DD} ≤ 5.5 V, V_{SS} = EV_{SS} = 0 V)

Parameter	Symbol	Conditions	HS (high-speed main) Mode		LS (low-speed main) Mode		LV (low-voltage main) Mode		Unit	
			MIN.	MAX.	MIN.	MIN.	MAX.	MIN.		
SCLA0 clock frequency	f _{SCL}	Standard mode: f _{CLK} ≥ 1 MHz	2.7 V ≤ EV _{DD} ≤ 5.5 V	0	100	0	100	0	100	kHz
			2.4 V ≤ EV _{DD} ≤ 5.5 V	0	100	0	100	0	100	
			1.8 V ≤ EV _{DD} ≤ 5.5 V			0	100	0	100	
			1.6 V ≤ EV _{DD} ≤ 5.5 V					0	100	
Setup time of restart condition	t _{SU:STA}	2.7 V ≤ EV _{DD} ≤ 5.5 V	4.7		4.7		4.7		μs	
		2.4 V ≤ EV _{DD} ≤ 5.5 V	4.7		4.7		4.7			
		1.8 V ≤ EV _{DD} ≤ 5.5 V			4.7		4.7			
		1.6 V ≤ EV _{DD} ≤ 5.5 V					4.7			
Hold time ^{Note 1}	t _{HD:STA}	2.7 V ≤ EV _{DD} ≤ 5.5 V	4.0		4.0		4.0		μs	
		2.4 V ≤ EV _{DD} ≤ 5.5 V	4.0		4.0		4.0			
		1.8 V ≤ EV _{DD} ≤ 5.5 V			4.0		4.0			
		1.6 V ≤ EV _{DD} ≤ 5.5 V					4.0			
Hold time when SCLA0 = "L"	t _{LOW}	2.7 V ≤ EV _{DD} ≤ 5.5 V	4.7		4.7		4.7		μs	
		2.4 V ≤ EV _{DD} ≤ 5.5 V	4.7		4.7		4.7			
		1.8 V ≤ EV _{DD} ≤ 5.5 V			4.7		4.7			
		1.6 V ≤ EV _{DD} ≤ 5.5 V					4.7			
Hold time when SCLA0 = "H"	t _{HIGH}	2.7 V ≤ EV _{DD} ≤ 5.5 V	4.0		4.0		4.0		μs	
		2.4 V ≤ EV _{DD} ≤ 5.5 V	4.0		4.0		4.0			
		1.8 V ≤ EV _{DD} ≤ 5.5 V			4.0		4.0			
		1.6 V ≤ EV _{DD} ≤ 5.5 V					4.0			
Data setup time (reception)	t _{SU:DAT}	2.7 V ≤ EV _{DD} ≤ 5.5 V	250		250		250		ns	
		2.4 V ≤ EV _{DD} ≤ 5.5 V	250		250		250			
		1.8 V ≤ EV _{DD} ≤ 5.5 V			250		250			
		1.6 V ≤ EV _{DD} ≤ 5.5 V					250			
Data hold time (transmission) ^{Note 2}	t _{HD:DAT}	2.7 V ≤ EV _{DD} ≤ 5.5 V	0	3.45	0	3.45	0	3.45	μs	
		2.4 V ≤ EV _{DD} ≤ 5.5 V	0	3.45	0	3.45	0	3.45		
		1.8 V ≤ EV _{DD} ≤ 5.5 V			0	3.45	0	3.45		
		1.6 V ≤ EV _{DD} ≤ 5.5 V					0	3.45		
Setup time of stop condition	t _{SU:STO}	2.7 V ≤ EV _{DD} ≤ 5.5 V	4.0		4.0		4.0		μs	
		2.4 V ≤ EV _{DD} ≤ 5.5 V	4.0		4.0		4.0			
		1.8 V ≤ EV _{DD} ≤ 5.5 V			4.0		4.0			
		1.6 V ≤ EV _{DD} ≤ 5.5 V					4.0			
Bus-free time	t _{BUF}	2.7 V ≤ EV _{DD} ≤ 5.5 V	4.7		4.7		4.7		μs	
		2.4 V ≤ EV _{DD} ≤ 5.5 V	4.7		4.7		4.7			
		1.8 V ≤ EV _{DD} ≤ 5.5 V			4.7		4.7			
		1.6 V ≤ EV _{DD} ≤ 5.5 V					4.7			

(Notes and Remark are listed on the next page.)

- Notes**
1. The first clock pulse is generated after this period when the start/restart condition is detected.
 2. The maximum value (MAX.) of t_{HD:DAT} is during normal transfer and a wait state is inserted in the $\overline{\text{ACK}}$ (acknowledge) timing.

Remark The maximum value of C_b (communication line capacitance) and the value of R_b (communication line pull-up resistor) at that time in each mode are as follows.

Standard mode: C_b = 400 pF, R_b = 2.7 kΩ

(2) I²C fast mode(T_A = -40 to +85°C, 1.6 V ≤ EV_{DD} = V_{DD} ≤ 5.5 V, V_{SS} = EV_{SS} = 0 V)

Parameter	Symbol	Conditions	HS (high-speed main) Mode		LS (low-speed main) Mode		LV (low-voltage main) Mode		Unit	
			MIN.	MAX.	MIN.	MIN.	MAX.	MIN.		
SCLA0 clock frequency	f _{SCL}	Fast mode: f _{CLK} ≥ 3.5 MHz	2.7 V ≤ EV _{DD} ≤ 5.5 V	0	400	0	400	0	400	kHz
			2.4 V ≤ EV _{DD} ≤ 5.5 V	0	400	0	400	0	400	
			1.8 V ≤ EV _{DD} ≤ 5.5 V			0	400	0	400	
Setup time of restart condition	t _{SU:STA}	2.7 V ≤ EV _{DD} ≤ 5.5 V	0.6		0.6		0.6		μs	
		2.4 V ≤ EV _{DD} ≤ 5.5 V	0.6		0.6		0.6			
		1.8 V ≤ EV _{DD} ≤ 5.5 V			0.6		0.6			
Hold time ^{Note 1}	t _{HD:STA}	2.7 V ≤ EV _{DD} ≤ 5.5 V	0.6		0.6		0.6		μs	
		2.4 V ≤ EV _{DD} ≤ 5.5 V	0.6		0.6		0.6			
		1.8 V ≤ EV _{DD} ≤ 5.5 V			0.6		0.6			
Hold time when SCLA0 = "L"	t _{LOW}	2.7 V ≤ EV _{DD} ≤ 5.5 V	1.3		1.3		1.3		μs	
		2.4 V ≤ EV _{DD} ≤ 5.5 V	1.3		1.3		1.3			
		1.8 V ≤ EV _{DD} ≤ 5.5 V			1.3		1.3			
Hold time when SCLA0 = "H"	t _{HIGH}	2.7 V ≤ EV _{DD} ≤ 5.5 V	0.6		0.6		0.6		μs	
		2.4 V ≤ EV _{DD} ≤ 5.5 V	0.6		0.6		0.6			
		1.8 V ≤ EV _{DD} ≤ 5.5 V			0.6		0.6			
Data setup time (reception)	t _{SU:DAT}	2.7 V ≤ EV _{DD} ≤ 5.5 V	100		100		100		ns	
		2.4 V ≤ EV _{DD} ≤ 5.5 V	100		100		100			
		1.8 V ≤ EV _{DD} ≤ 5.5 V			100		100			
Data hold time (transmission) ^{Note 2}	t _{HD:DAT}	2.7 V ≤ EV _{DD} ≤ 5.5 V	0	0.9	0	0.9	0	0.9	μs	
		2.4 V ≤ EV _{DD} ≤ 5.5 V	0	0.9	0	0.9	0	0.9		
		1.8 V ≤ EV _{DD} ≤ 5.5 V			0	0.9	0	0.9		
Setup time of stop condition	t _{SU:STO}	2.7 V ≤ EV _{DD} ≤ 5.5 V	0.6		0.6		0.6		μs	
		2.4 V ≤ EV _{DD} ≤ 5.5 V	0.6		0.6		0.6			
		1.8 V ≤ EV _{DD} ≤ 5.5 V			0.6		0.6			
Bus-free time	t _{BUF}	2.7 V ≤ EV _{DD} ≤ 5.5 V	1.3		1.3		1.3		μs	
		2.4 V ≤ EV _{DD} ≤ 5.5 V	1.3		1.3		1.3			
		1.8 V ≤ EV _{DD} ≤ 5.5 V			1.3		1.3			

Notes 1. The first clock pulse is generated after this period when the start/restart condition is detected.

2. The maximum value (MAX.) of t_{HD:DAT} is during normal transfer and a wait state is inserted in the ACK (acknowledge) timing.

Remark The maximum value of C_b (communication line capacitance) and the value of R_b (communication line pull-up resistor) at that time in each mode are as follows.

Fast mode: C_b = 320 pF, R_b = 1.1 kΩ

(3) I²C fast mode plus

(T_A = -40 to +85°C, 1.6 V ≤ EV_{DD} = V_{DD} ≤ 5.5 V, V_{SS} = EV_{SS} = 0 V)

Parameter	Symbol	Conditions	HS (high-speed main) Mode		LS (low-speed main) Mode		LV (low-voltage main) Mode		Unit
			MIN.	MAX.	MIN.	MAX.	MIN.	MAX.	
SCLA0 clock frequency	f _{SCL}	Fast mode plus: f _{CLK} ≥ 10 MHz 2.7 V ≤ EV _{DD} ≤ 5.5 V	0	1000	—	—	—	—	kHz
Setup time of restart condition	t _{SU:STA}	2.7 V ≤ EV _{DD} ≤ 5.5 V	0.26		—	—	—	—	μs
Hold time ^{Note 1}	t _{HD:STA}	2.7 V ≤ EV _{DD} ≤ 5.5 V	0.26		—	—	—	—	μs
Hold time when SCLA0 = "L"	t _{LOW}	2.7 V ≤ EV _{DD} ≤ 5.5 V	0.5		—	—	—	—	μs
Hold time when SCLA0 = "H"	t _{HIGH}	2.7 V ≤ EV _{DD} ≤ 5.5 V	0.26		—	—	—	—	μs
Data setup time (reception)	t _{SU:DAT}	2.7 V ≤ EV _{DD} ≤ 5.5 V	50		—	—	—	—	μs
Data hold time (transmission) ^{Note 2}	t _{HD:DAT}	2.7 V ≤ EV _{DD} ≤ 5.5 V	0	0.45	—	—	—	—	μs
Setup time of stop condition	t _{SU:STO}	2.7 V ≤ EV _{DD} ≤ 5.5 V	0.26		—	—	—	—	μs
Bus-free time	t _{BUF}	2.7 V ≤ EV _{DD} ≤ 5.5 V	0.5		—	—	—	—	μs

- Notes**
- The first clock pulse is generated after this period when the start/restart condition is detected.
 - The maximum value (MAX.) of t_{HD:DAT} is during normal transfer and a wait state is inserted in the ACK (acknowledge) timing.

Caution The values in the above table are applied even when bit 2 (PIOR2) in the peripheral I/O redirection register (PIOR) is 1. At this time, the pin characteristics (I_{OH1}, I_{OL1}, V_{OH1}, V_{OL1}) must satisfy the values in the redirect destination.

Remark The maximum value of C_b (communication line capacitance) and the value of R_b (communication line pull-up resistor) at that time in each mode are as follows.

Fast mode plus: C_b = 120 pF, R_b = 1.1 kΩ

IICA serial transfer timing

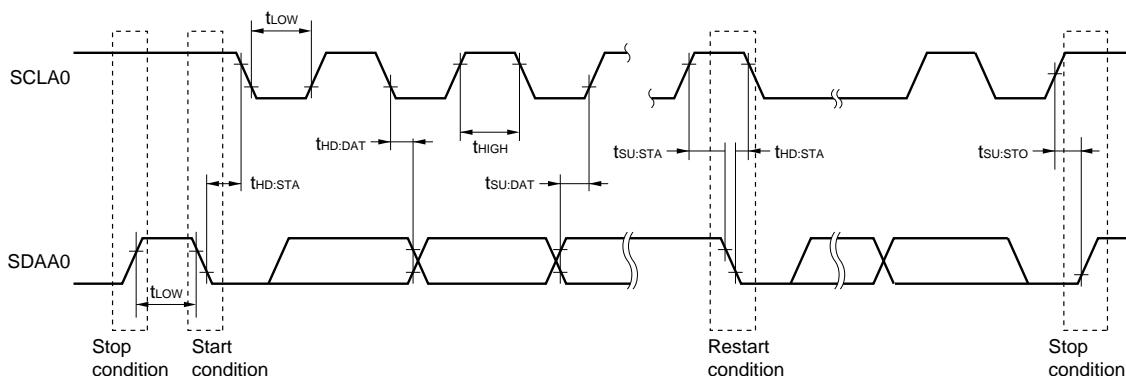

2.6 Analog Characteristics

2.6.1 A/D converter characteristics

Classification of A/D converter characteristics

Input channel	Reference Voltage		
	Reference voltage (+) = AV _{REFP} Reference voltage (-) = AV _{REFM}	Reference voltage (+) = V _{DD} Reference voltage (-) = V _{SS}	Reference voltage (+) = V _{BGR} Reference voltage (-) = AV _{REFM}
ANI0, ANI1	–	Refer to 2.6.1 (3).	Refer to 2.6.1 (4).
ANI16 to ANI23	Refer to 2.6.1 (2).		
Internal reference voltage Temperature sensor output voltage	Refer to 2.6.1 (1).		–

(1) When reference voltage (+) = AV_{REFP}/ANI0 (ADREFP1 = 0, ADREFP0 = 1), reference voltage (-) = AV_{REFM}/ANI1 (ADREFM = 1), target pin : internal reference voltage, and temperature sensor output voltage

(T_A = -40 to +85°C, 2.4 V ≤ EV_{DD} = V_{DD} ≤ 5.5 V, 1.6 V ≤ AV_{REFP} ≤ V_{DD} ≤ 5.5 V, V_{SS} = EV_{SS} = 0 V, Reference voltage (+) = AV_{REFP}, Reference voltage (-) = AV_{REFM} = 0 V)

Parameter	Symbol	Conditions	MIN.	TYP.	MAX.	Unit	
Resolution	RES		8		10	bit	
Overall error ^{Note 1}	AINL	10-bit resolution AV _{REFP} = V _{DD} ^{Note 3}	1.8 V ≤ V _{DD} ≤ 5.5 V		1.2	±3.5	LSB
			1.6 V ≤ V _{DD} ≤ 5.5 V ^{Note 4}		1.2	±7.0	LSB
Conversion time	t _{CONV}	10-bit resolution Target pin: Internal reference voltage, and temperature sensor output voltage (HS (high-speed main) mode)	3.6 V ≤ V _{DD} ≤ 5.5 V	2.375		39	μs
			2.7 V ≤ V _{DD} ≤ 5.5 V	3.5625		39	μs
			2.4 V ≤ V _{DD} ≤ 5.5 V	17		39	μs
Zero-scale error ^{Notes 1, 2}	E _{ZS}	10-bit resolution AV _{REFP} = V _{DD} ^{Note 3}	1.8 V ≤ AV _{REFP} ≤ 5.5 V			±0.25	%FSR
			1.6 V ≤ AV _{REFP} ≤ 5.5 V ^{Note 4}			±0.50	%FSR
Full-scale error ^{Notes 1, 2}	E _{FS}	10-bit resolution AV _{REFP} = V _{DD} ^{Note 3}	1.8 V ≤ AV _{REFP} ≤ 5.5 V			±0.25	%FSR
			1.6 V ≤ AV _{REFP} ≤ 5.5 V ^{Note 4}			±0.50	%FSR
Integral linearity error ^{Note 1}	ILE	10-bit resolution AV _{REFP} = V _{DD} ^{Note 3}	1.8 V ≤ V _{DD} ≤ 5.5 V			±2.5	LSB
			1.6 V ≤ V _{DD} ≤ 5.5 V ^{Note 4}			±5.0	LSB
Differential linearity error ^{Note 1}	DLE	10-bit resolution AV _{REFP} = V _{DD} ^{Note 3}	1.8 V ≤ V _{DD} ≤ 5.5 V			±1.5	LSB
			1.6 V ≤ V _{DD} ≤ 5.5 V ^{Note 4}			±2.0	LSB
Analog input voltage	V _{AIN}	Internal reference voltage (2.4 V ≤ V _{DD} ≤ 5.5 V, HS (high-speed main) mode)			V _{BGR} ^{Note 5}	V	
	V _{BGR}	Temperature sensor output voltage (2.4 V ≤ V _{DD} ≤ 5.5 V, HS (high-speed main) mode)			V _{TMPS25} ^{Note 5}	V	

Notes 1. Excludes quantization error (±1/2 LSB).

2. This value is indicated as a ratio (%FSR) to the full-scale value.

3. When AV_{REFP} < V_{DD}, the MAX. values are as follows.

Overall error: Add ±1.0 LSB to the MAX. value when AV_{REFP} = V_{DD}.

Zero-scale error/Full-scale error: Add ±0.05%FSR to the MAX. value when AV_{REFP} = V_{DD}.

Integral linearity error/Differential linearity error: Add ±0.5 LSB to the MAX. value when AV_{REFP} = V_{DD}.

4. Values when the conversion time is set to 57 μs (min.) and 95 μs (max.).

5. Refer to 2.6.2 Temperature sensor/internal reference voltage characteristics.

(2) When reference voltage (+) = AV_{REFP}/ANI0 (ADREFP1 = 0, ADREFP0 = 1), reference voltage (-) = AV_{REFM}/ANI1 (ADREFM = 1), target pin : ANI16 to ANI23

(T_A = -40 to +85°C, 1.6 V ≤ EV_{DD} = V_{DD} ≤ 5.5 V, 1.6 V ≤ AV_{REFP} ≤ V_{DD} ≤ 5.5 V, V_{SS} = EV_{SS} = 0 V, Reference voltage (+) = AV_{REFP}, Reference voltage (-) = AV_{REFM} = 0 V)

Parameter	Symbol	Conditions	MIN.	TYP.	MAX.	Unit	
Resolution	RES		8		10	bit	
Overall error ^{Note 1}	AINL	10-bit resolution AV _{REFP} = EV _{DD} = V _{DD} ^{Note 3}	1.8 V ≤ AV _{REFP} ≤ 5.5 V		1.2	±5.0	LSB
			1.6 V ≤ AV _{REFP} ≤ 5.5 V ^{Note 4}		1.2	±8.5	LSB
Conversion time	t _{CONV}	10-bit resolution AV _{REFP} = EV _{DD} = V _{DD} ^{Note 3}	3.6 V ≤ V _{DD} ≤ 5.5 V	2.125		39	μs
			2.7 V ≤ V _{DD} ≤ 5.5 V		3.1875	39	μs
			1.8 V ≤ V _{DD} ≤ 5.5 V		17	39	μs
			1.6 V ≤ V _{DD} ≤ 5.5 V		57	95	μs
Zero-scale error ^{Notes 1, 2}	E _{ZS}	10-bit resolution AV _{REFP} = EV _{DD} = V _{DD} ^{Note 3}	1.8 V ≤ AV _{REFP} ≤ 5.5 V			±0.35	%FSR
			1.6 V ≤ AV _{REFP} ≤ 5.5 V ^{Note 4}			±0.60	%FSR
Full-scale error ^{Notes 1, 2}	E _{FS}	10-bit resolution AV _{REFP} = EV _{DD} = V _{DD} ^{Note 3}	1.8 V ≤ AV _{REFP} ≤ 5.5 V			±0.35	%FSR
			1.6 V ≤ AV _{REFP} ≤ 5.5 V ^{Note 4}			±0.60	%FSR
Integral linearity error ^{Note 1}	ILE	10-bit resolution AV _{REFP} = EV _{DD} = V _{DD} ^{Note 3}	1.8 V ≤ AV _{REFP} ≤ 5.5 V			±3.5	LSB
			1.6 V ≤ AV _{REFP} ≤ 5.5 V ^{Note 4}			±6.0	LSB
Differential linearity error ^{Note 1}	DLE	10-bit resolution AV _{REFP} = EV _{DD} = V _{DD} ^{Note 3}	1.8 V ≤ AV _{REFP} ≤ 5.5 V			±2.0	LSB
			1.6 V ≤ AV _{REFP} ≤ 5.5 V ^{Note 4}			±2.5	LSB
Analog input voltage	V _{AIN}		0		AV _{REFP} and EV _{DD}	V	

Notes 1. Excludes quantization error (±1/2 LSB).

2. This value is indicated as a ratio (%FSR) to the full-scale value.

3. When AV_{REFP} < EV_{DD} = V_{DD}, the MAX. values are as follows.

Overall error: Add ±4.0 LSB to the MAX. value when AV_{REFP} = V_{DD}.

Zero-scale error/Full-scale error: Add ±0.20%FSR to the MAX. value when AV_{REFP} = V_{DD}.

Integral linearity error/Differential linearity error: Add ±2.0 LSB to the MAX. value when AV_{REFP} = V_{DD}.

4. When the conversion time is set to 57 μs (min.) and 95 μs (max.).

(3) When reference voltage (+) = V_{DD} (ADREFP1 = 0, ADREFP0 = 0), reference voltage (-) = V_{SS} (ADREFM = 0), target pin : ANI0, ANI1, ANI16 to ANI23, internal reference voltage, and temperature sensor output voltage

(T_A = -40 to +85°C, 1.6 V ≤ EV_{DD} = V_{DD} ≤ 5.5 V, V_{SS} = EV_{SS} = 0 V, Reference voltage (+) = V_{DD}, Reference voltage (-) = V_{SS})

Parameter	Symbol	Conditions	MIN.	TYP.	MAX.	Unit	
Resolution	RES		8		10	bit	
Overall error ^{Note 1}	AINL	10-bit resolution	1.8 V ≤ V _{DD} ≤ 5.5 V		1.2	±7.0	LSB
			1.6 V ≤ V _{DD} ≤ 5.5 V ^{Note 3}		1.2	±10.5	LSB
Conversion time	t _{CONV}	10-bit resolution	3.6 V ≤ V _{DD} ≤ 5.5 V	2.125		39	μs
			2.7 V ≤ V _{DD} ≤ 5.5 V	3.1875		39	μs
			1.8 V ≤ V _{DD} ≤ 5.5 V	17		39	μs
			1.6 V ≤ V _{DD} ≤ 5.5 V	57		95	μs
		10-bit resolution Target pin: Internal reference voltage, and temperature sensor output voltage (HS (high-speed main) mode)	3.6 V ≤ V _{DD} ≤ 5.5 V	2.375		39	μs
			2.7 V ≤ V _{DD} ≤ 5.5 V	3.5625		39	μs
Zero-scale error ^{Notes 1, 2}	E _{ZS}	10-bit resolution	1.8 V ≤ V _{DD} ≤ 5.5 V			±0.60	%FSR
			1.6 V ≤ V _{DD} ≤ 5.5 V ^{Note 3}			±0.85	%FSR
Full-scale error ^{Notes 1, 2}	E _{FS}	10-bit resolution	1.8 V ≤ V _{DD} ≤ 5.5 V			±0.60	%FSR
			1.6 V ≤ V _{DD} ≤ 5.5 V ^{Note 3}			±0.85	%FSR
Integral linearity error ^{Note 1}	ILE	10-bit resolution	1.8 V ≤ V _{DD} ≤ 5.5 V			±4.0	LSB
			1.6 V ≤ V _{DD} ≤ 5.5 V ^{Note 3}			±6.5	LSB
Differential linearity error ^{Note 1}	DLE	10-bit resolution	1.8 V ≤ V _{DD} ≤ 5.5 V			±2.0	LSB
			1.6 V ≤ V _{DD} ≤ 5.5 V ^{Note 3}			±2.5	LSB
Analog input voltage	V _{AIN}	ANI0, ANI1	0		V _{DD}	V	
		ANI16 to ANI23	0		EV _{DD}	V	
		Internal reference voltage (2.4 V ≤ V _{DD} ≤ 5.5 V, HS (high-speed main) mode)			V _{BGR} ^{Note 4}	V	
		Temperature sensor output voltage (2.4 V ≤ V _{DD} ≤ 5.5 V, HS (high-speed main) mode)			V _{TMPS25} ^{Note 4}	V	

Notes 1. Excludes quantization error (±1/2 LSB).

2. This value is indicated as a ratio (%FSR) to the full-scale value.

3. When the conversion time is set to 57 μs (min.) and 95 μs (max.).

4. Refer to 2.6.2 Temperature sensor/internal reference voltage characteristics.

(4) When reference voltage (+) = Internal reference voltage (ADREFP1 = 1, ADREFP0 = 0), reference voltage (-) = AV_{REFM}/ANI1 (ADREFM = 1), target pin : ANI0, ANI16 to ANI23

(T_A = -40 to +85°C, 2.4 V ≤ EV_{DD} = V_{DD} ≤ 5.5 V, V_{SS} = EV_{SS} = 0 V, Reference voltage (+) = V_{BGR} ^{Note 3}, Reference voltage (-) = AV_{REFM} ^{Note 4} = 0 V, HS (high-speed main) mode)

Parameter	Symbol	Conditions		MIN.	TYP.	MAX.	Unit
Resolution	RES			8			bit
Conversion time	t _{CONV}	8-bit resolution	2.4 V ≤ V _{DD} ≤ 5.5 V	17		39	μs
Zero-scale error ^{Notes 1, 2}	E _{ZS}	8-bit resolution	2.4 V ≤ V _{DD} ≤ 5.5 V			±0.60	%FSR
Integral linearity error ^{Note 1}	ILE	8-bit resolution	2.4 V ≤ V _{DD} ≤ 5.5 V			±2.0	LSB
Differential linearity error ^{Note 1}	DLE	8-bit resolution	2.4 V ≤ V _{DD} ≤ 5.5 V			±1.0	LSB
Analog input voltage	V _{AIN}			0		V _{BGR} ^{Note 3}	V

Notes 1. Excludes quantization error (±1/2 LSB).

2. This value is indicated as a ratio (%FSR) to the full-scale value.

3. Refer to **2.6.2 Temperature sensor/internal reference voltage characteristics**.

4. When reference voltage (-) = V_{SS}, the MAX. values are as follows.

Zero-scale error: Add ±0.35%FSR to the MAX. value when reference voltage (-) = AV_{REFM}.

Integral linearity error: Add ±0.5 LSB to the MAX. value when reference voltage (-) = AV_{REFM}.

Differential linearity error: Add ±0.2 LSB to the MAX. value when reference voltage (-) = AV_{REFM}.

2.6.2 Temperature sensor/internal reference voltage characteristics

(T_A = -40 to +85°C, 2.4 V ≤ EV_{DD} = V_{DD} ≤ 5.5 V, V_{SS} = EV_{SS} = 0 V) (HS (high-speed main) mode)

Parameter	Symbol	Conditions	MIN.	TYP.	MAX.	Unit
Temperature sensor output voltage	V _{TMPS25}	Setting ADS register = 80H, T _A = +25°C		1.05		V
Internal reference voltage	V _{BGR}	Setting ADS register = 81H	1.38	1.45	1.5	V
Temperature coefficient	F _{VTMPS}	Temperature sensor that depends on the temperature		-3.6		mV/°C
Operation stabilization wait time	t _{AMP}		5			μs

2.6.3 POR circuit characteristics

 $(T_A = -40$ to $+85^\circ\text{C}$, $V_{SS} = 0$ V)

Parameter	Symbol	Conditions	MIN.	TYP.	MAX.	Unit
Detection voltage	V_{POR}	Power supply rise time	1.47	1.51	1.55	V
	V_{PDR}	Power supply fall time	1.46	1.50	1.54	V
Minimum pulse width ^{Note}	T_{PW}		300			μs

Note Minimum time required for a POR reset when V_{DD} exceeds below V_{PDR} . This is also the minimum time required for a POR reset from when V_{DD} exceeds below 0.7 V to when V_{DD} exceeds V_{POR} while STOP mode is entered or the main system clock is stopped through setting bit 0 (HIOSTOP) and bit 7 (MSTOP) in the clock operation status control register (CSC).

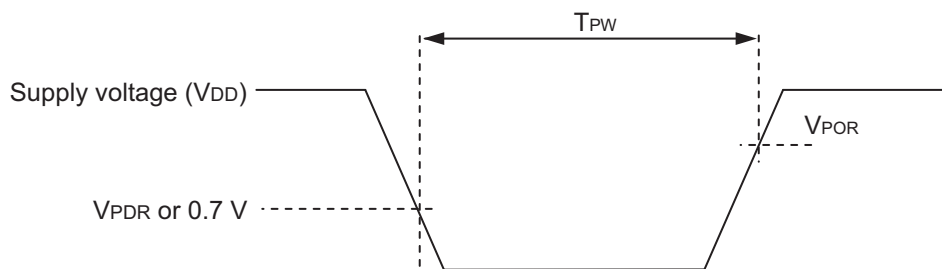

2.6.4 LVD circuit characteristics

(T_A = -40 to +85°C, V_{PDR} ≤ E_{VDD} = V_{DD} ≤ 5.5 V, V_{SS} = E_{VSS} = 0 V)

Parameter		Symbol	Conditions	MIN.	TYP.	MAX.	Unit
Detection voltage	Supply voltage level	V _{LVD0}	Power supply rise time	3.98	4.06	4.14	V
			Power supply fall time	3.90	3.98	4.06	V
		V _{LVD1}	Power supply rise time	3.68	3.75	3.82	V
			Power supply fall time	3.60	3.67	3.74	V
		V _{LVD2}	Power supply rise time	3.07	3.13	3.19	V
			Power supply fall time	3.00	3.06	3.12	V
		V _{LVD3}	Power supply rise time	2.96	3.02	3.08	V
			Power supply fall time	2.90	2.96	3.02	V
		V _{LVD4}	Power supply rise time	2.86	2.92	2.97	V
			Power supply fall time	2.80	2.86	2.91	V
		V _{LVD5}	Power supply rise time	2.76	2.81	2.87	V
			Power supply fall time	2.70	2.75	2.81	V
		V _{LVD6}	Power supply rise time	2.66	2.71	2.76	V
			Power supply fall time	2.60	2.65	2.70	V
		V _{LVD7}	Power supply rise time	2.56	2.61	2.66	V
			Power supply fall time	2.50	2.55	2.60	V
		V _{LVD8}	Power supply rise time	2.45	2.50	2.55	V
			Power supply fall time	2.40	2.45	2.50	V
		V _{LVD9}	Power supply rise time	2.05	2.09	2.13	V
			Power supply fall time	2.00	2.04	2.08	V
		V _{LVD10}	Power supply rise time	1.94	1.98	2.02	V
			Power supply fall time	1.90	1.94	1.98	V
		V _{LVD11}	Power supply rise time	1.84	1.88	1.91	V
			Power supply fall time	1.80	1.84	1.87	V
V _{LVD12}	Power supply rise time	1.74	1.77	1.81	V		
	Power supply fall time	1.70	1.73	1.77	V		
V _{LVD13}	Power supply rise time	1.64	1.67	1.70	V		
	Power supply fall time	1.60	1.63	1.66	V		
Minimum pulse width		t _{LW}		300			μs
Detection delay time		t _{LD}				300	μs

LVD Detection Voltage of Interrupt & Reset Mode(T_A = -40 to +85°C, V_{PDR} ≤ EV_{DD} = V_{DD} ≤ 5.5 V, V_{SS} = EV_{SS} = 0 V)

Parameter	Symbol	Conditions	MIN.	TYP.	MAX.	Unit	
Interrupt and reset mode	V _{LVDA0}	V _{POC2} , V _{POC1} , V _{POC0} = 0, 0, 0, falling reset voltage	1.60	1.63	1.66	V	
	V _{LVDA1}	LVIS1, LVIS0 = 1, 0	Rising release reset voltage	1.74	1.77	1.81	V
			Falling interrupt voltage	1.70	1.73	1.77	V
	V _{LVDA2}	LVIS1, LVIS0 = 0, 1	Rising release reset voltage	1.84	1.88	1.91	V
			Falling interrupt voltage	1.80	1.84	1.87	V
	V _{LVDA3}	LVIS1, LVIS0 = 0, 0	Rising release reset voltage	2.86	2.92	2.97	V
			Falling interrupt voltage	2.80	2.86	2.91	V
	V _{LVDB1}	V _{POC2} , V _{POC1} , V _{POC0} = 0, 0, 1, falling reset voltage	1.80	1.84	1.87	V	
	V _{LVDB2}	LVIS1, LVIS0 = 1, 0	Rising release reset voltage	1.94	1.98	2.02	V
			Falling interrupt voltage	1.90	1.94	1.98	V
	V _{LVDB3}	LVIS1, LVIS0 = 0, 1	Rising release reset voltage	2.05	2.09	2.13	V
			Falling interrupt voltage	2.00	2.04	2.08	V
	V _{LVDB4}	LVIS1, LVIS0 = 0, 0	Rising release reset voltage	3.07	3.13	3.19	V
			Falling interrupt voltage	3.00	3.06	3.12	V
	V _{LVDC0}	V _{POC2} , V _{POC1} , V _{POC0} = 0, 1, 0, falling reset voltage	2.40	2.45	2.50	V	
	V _{LVDC1}	LVIS1, LVIS0 = 1, 0	Rising release reset voltage	2.56	2.61	2.66	V
			Falling interrupt voltage	2.50	2.55	2.60	V
	V _{LVDC2}	LVIS1, LVIS0 = 0, 1	Rising release reset voltage	2.66	2.71	2.76	V
			Falling interrupt voltage	2.60	2.65	2.70	V
	V _{LVDC3}	LVIS1, LVIS0 = 0, 0	Rising release reset voltage	3.68	3.75	3.82	V
			Falling interrupt voltage	3.60	3.67	3.74	V
	V _{LVDD0}	V _{POC2} , V _{POC1} , V _{POC0} = 0, 1, 1, falling reset voltage	2.70	2.75	2.81	V	
	V _{LVDD1}	LVIS1, LVIS0 = 1, 0	Rising release reset voltage	2.86	2.92	2.97	V
			Falling interrupt voltage	2.80	2.86	2.91	V
V _{LVDD2}	LVIS1, LVIS0 = 0, 1	Rising release reset voltage	2.96	3.02	3.08	V	
		Falling interrupt voltage	2.90	2.96	3.02	V	
V _{LVDD3}	LVIS1, LVIS0 = 0, 0	Rising release reset voltage	3.98	4.06	4.14	V	
		Falling interrupt voltage	3.90	3.98	4.06	V	

2.6.5 Supply voltage rise time

(T_A = -40 to +85°C, V_{SS} = 0 V)

Parameter	Symbol	Conditions	MIN.	TYP.	MAX.	Unit
Power supply voltage rising slope	S _{VDD}				54	V/ms

Caution Make sure to keep the internal reset state by the LVD circuit or an external reset until V_{DD} reaches the operating voltage range shown in 2.4 AC Characteristics.

2.7 LCD Characteristics

2.7.1 Resistance division method

(1) Static display mode

(T_A = -40 to +85°C, V_{L4} (MIN.) ≤ V_{DD} ≤ 5.5 V, V_{SS} = 0 V)

Parameter	Symbol	Conditions	MIN.	TYP.	MAX.	Unit
LCD drive voltage	V _{L4}		2.0		V _{DD}	V

(2) 1/2 bias method, 1/4 bias method

(T_A = -40 to +85°C, V_{L4} (MIN.) ≤ V_{DD} ≤ 5.5 V, V_{SS} = 0 V)

Parameter	Symbol	Conditions	MIN.	TYP.	MAX.	Unit
LCD drive voltage	V _{L4}		2.7		V _{DD}	V

(3) 1/3 bias method

(T_A = -40 to +85°C, V_{L4} (MIN.) ≤ V_{DD} ≤ 5.5 V, V_{SS} = 0 V)

Parameter	Symbol	Conditions	MIN.	TYP.	MAX.	Unit
LCD drive voltage	V _{L4}		2.5		V _{DD}	V

2.7.2 Internal voltage boosting method

(1) 1/3 bias method

(T_A = -40 to +85°C, 1.8 V ≤ V_{DD} ≤ 5.5 V, V_{SS} = 0 V)

Parameter	Symbol	Conditions	MIN.	TYP.	MAX.	Unit	
LCD output voltage variation range	V _{L1}	C1 to C4 ^{Note 1} = 0.47 μF	VLCD = 04H	0.90	1.00	1.08	V
			VLCD = 05H	0.95	1.05	1.13	V
			VLCD = 06H	1.00	1.10	1.18	V
			VLCD = 07H	1.05	1.15	1.23	V
			VLCD = 08H	1.10	1.20	1.28	V
			VLCD = 09H	1.15	1.25	1.33	V
			VLCD = 0AH	1.20	1.30	1.38	V
			VLCD = 0BH	1.25	1.35	1.43	V
			VLCD = 0CH	1.30	1.40	1.48	V
			VLCD = 0DH	1.35	1.45	1.53	V
			VLCD = 0EH	1.40	1.50	1.58	V
			VLCD = 0FH	1.45	1.55	1.63	V
			VLCD = 10H	1.50	1.60	1.68	V
			VLCD = 11H	1.55	1.65	1.73	V
VLCD = 12H	1.60	1.70	1.78	V			
VLCD = 13H	1.65	1.75	1.83	V			
Doubler output voltage	V _{L2}	C1 to C4 ^{Note 1} = 0.47 μF	2 V _{L1} - 0.1	2 V _{L1}	2 V _{L1}	V	
Tripler output voltage	V _{L4}	C1 to C4 ^{Note 1} = 0.47 μF	3 V _{L1} - 0.15	3 V _{L1}	3 V _{L1}	V	
Reference voltage setup time ^{Note 2}	t _{WAIT1}		5			ms	
Voltage boost wait time ^{Note 3}	t _{WAIT2}	C1 to C4 ^{Note 1} = 0.47 μF	500			ms	

Notes 1. This is a capacitor that is connected between voltage pins used to drive the LCD.

C1: A capacitor connected between CAPH and CAPL

C2: A capacitor connected between V_{L1} and GND

C3: A capacitor connected between V_{L2} and GND

C4: A capacitor connected between V_{L4} and GND

C1 = C2 = C3 = C4 = 0.47 μF ± 30%

- This is the time required to wait from when the reference voltage is specified by using the VLCD register (or when the internal voltage boosting method is selected [by setting the MDSET1 and MDSET0 bits of the LCDM0 register to 01B] if the default value reference voltage is used) until voltage boosting starts (VLCON = 1).
- This is the wait time from when voltage boosting is started (VLCON = 1) until display is enabled (LCDON = 1).

(2) 1/4 bias method**(T_A = -40 to +85°C, 1.8 V ≤ V_{DD} ≤ 5.5 V, V_{SS} = 0 V)**

Parameter	Symbol	Conditions	MIN.	TYP.	MAX.	Unit	
LCD output voltage variation range	V _{L1} ^{Note 4}	C1 to C5 ^{Note 1} = 0.47 μF	VLCD = 04H	0.90	1.00	1.08	V
			VLCD = 05H	0.95	1.05	1.13	V
			VLCD = 06H	1.00	1.10	1.18	V
			VLCD = 07H	1.05	1.15	1.23	V
			VLCD = 08H	1.10	1.20	1.28	V
			VLCD = 09H	1.15	1.25	1.33	V
			VLCD = 0AH	1.20	1.30	1.38	V
			VLCD = 0BH	1.25	1.35	1.43	V
			VLCD = 0CH	1.30	1.40	1.48	V
			VLCD = 0DH	1.35	1.45	1.53	V
			VLCD = 0EH	1.40	1.50	1.58	V
			VLCD = 0FH	1.45	1.55	1.63	V
			VLCD = 10H	1.50	1.60	1.68	V
			VLCD = 11H	1.55	1.65	1.73	V
VLCD = 12H	1.60	1.70	1.78	V			
VLCD = 13H	1.65	1.75	1.83	V			
Doubler output voltage	V _{L2}	C1 to C5 ^{Note 1} = 0.47 μF	2 V _{L1} - 0.08	2 V _{L1}	2 V _{L1}	V	
Tripler output voltage	V _{L3}	C1 to C5 ^{Note 1} = 0.47 μF	3 V _{L1} - 0.12	3 V _{L1}	3 V _{L1}	V	
Quadruply output voltage	V _{L4} ^{Note 4}	C1 to C5 ^{Note 1} = 0.47 μF	4 V _{L1} - 0.16	4 V _{L1}	4 V _{L1}	V	
Reference voltage setup time ^{Note 2}	t _{WAIT1}		5			ms	
Voltage boost wait time ^{Note 3}	t _{WAIT2}	C1 to C5 ^{Note 1} = 0.47 μF	500			ms	

Notes 1. This is a capacitor that is connected between voltage pins used to drive the LCD.

C1: A capacitor connected between CAPH and CAPL

C2: A capacitor connected between V_{L1} and GNDC3: A capacitor connected between V_{L2} and GNDC4: A capacitor connected between V_{L3} and GNDC5: A capacitor connected between V_{L4} and GND

C1 = C2 = C3 = C4 = C5 = 0.47 μF ± 30%

- This is the time required to wait from when the reference voltage is specified by using the VLCD register (or when the internal voltage boosting method is selected [by setting the MDSET1 and MDSET0 bits of the LCDM0 register to 01B] if the default value reference voltage is used) until voltage boosting starts (VLCON = 1).
- This is the wait time from when voltage boosting is started (VLCON = 1) until display is enabled (LCDON = 1).
- V_{L4} must be 5.5 V or lower.

2.7.3 Capacitor split method**1/3 bias method****(T_A = -40 to +85°C, 2.2 V ≤ V_{DD} ≤ 5.5 V, V_{SS} = 0 V)**

Parameter	Symbol	Conditions	MIN.	TYP.	MAX.	Unit
V _{L4} voltage	V _{L4}	C1 to C4 = 0.47 μF ^{Note 2}		V _{DD}		V
V _{L2} voltage	V _{L2}	C1 to C4 = 0.47 μF ^{Note 2}	2/3 V _{L4} - 0.1	2/3 V _{L4}	2/3 V _{L4} + 0.1	V
V _{L1} voltage	V _{L1}	C1 to C4 = 0.47 μF ^{Note 2}	1/3 V _{L4} - 0.1	1/3 V _{L4}	1/3 V _{L4} + 0.1	V
Capacitor split wait time ^{Note 1}	t _{WAIT}		100			ms

- Notes**
1. This is the wait time from when voltage bucking is started (VLCON = 1) until display is enabled (LCDON = 1).
 2. This is a capacitor that is connected between voltage pins used to drive the LCD.
 - C1: A capacitor connected between CAPH and CAPL
 - C2: A capacitor connected between VL1 and GND
 - C3: A capacitor connected between VL2 and GND
 - C4: A capacitor connected between VL4 and GND
- C1 = C2 = C3 = C4 = 0.47 μF±30%

2.8 RAM Data Retention Characteristics

(T_A = -40 to +85°C, V_{SS} = 0 V)

Parameter	Symbol	Conditions	MIN.	TYP.	MAX.	Unit
Data retention supply voltage	V _{DDDR}		1.46 ^{Note}		5.5	V

Note This depends on the POR detection voltage. For a falling voltage, data in RAM are retained until the voltage reaches the level that triggers a POR reset but not once it reaches the level at which a POR reset is generated.

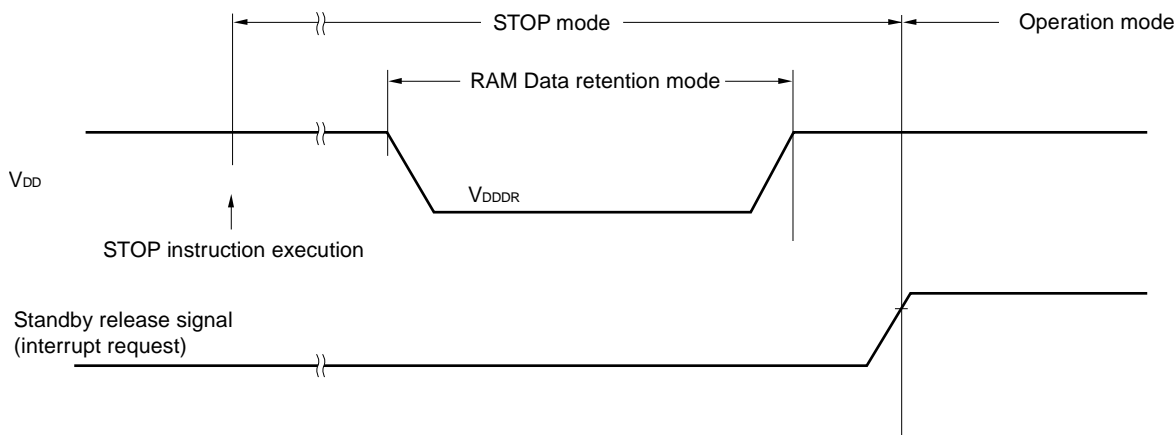

2.9 Flash Memory Programming Characteristics

(T_A = -40 to +85°C, 1.8 V ≤ EV_{DD} = V_{DD} ≤ 5.5 V, V_{SS} = EV_{SS} = 0 V)

Parameter	Symbol	Conditions	MIN.	TYP.	MAX.	Unit
System clock frequency	f _{CLK}	1.8 V ≤ V _{DD} ≤ 5.5 V	1		24	MHz
Number of code flash rewrites <small>Note 1, 2, 3</small>	C _{enwr}	Retained for 20 years T _A = 85°C	1,000			Times
Number of data flash rewrites <small>Note 1, 2, 3</small>		Retained for 1 year T _A = 25°C		1,000,000		
		Retained for 5 years T _A = 85°C	100,000			
		Retained for 20 years T _A = 85°C	10,000			

- Notes**
- 1 erase + 1 write after the erase is regarded as 1 rewrite.
The retaining years are until next rewrite after the rewrite.
 2. When using flash memory programmer and Renesas Electronics self programming library
 3. This characteristic indicates the flash memory characteristic and based on Renesas Electronics reliability test.

Remark When updating data multiple times, use the flash memory as one for updating data.

2.10 Dedicated Flash Memory Programmer Communication (UART)

(T_A = -40 to +85°C, 1.8 V ≤ EV_{DD} = V_{DD} ≤ 5.5 V, V_{SS} = EV_{SS} = 0 V)

Parameter	Symbol	Conditions	MIN.	TYP.	MAX.	Unit
Transfer rate		During flash memory programming	115,200		1,000,000	bps

2.11 Timing Specifications for Switching Flash Memory Programming Modes

(T_A = -40 to +85°C, 1.8 V ≤ EV_{DD} = V_{DD} ≤ 5.5 V, V_{SS} = EV_{SS} = 0 V)

Parameter	Symbol	Conditions	MIN.	TYP.	MAX.	Unit
Time to complete the communication for the initial setting after the external reset is released	t _{SUINIT}	POR and LVD reset must be released before the external reset is released.			100	ms
Time to release the external reset after the TOOL0 pin is set to the low level	t _{SU}	POR and LVD reset must be released before the external reset is released.	10			μs
Time to hold the TOOL0 pin at the low level after the external reset is released (excluding the processing time of the firmware to control the flash memory)	t _{HD}	POR and LVD reset must be released before the external reset is released.	1			ms

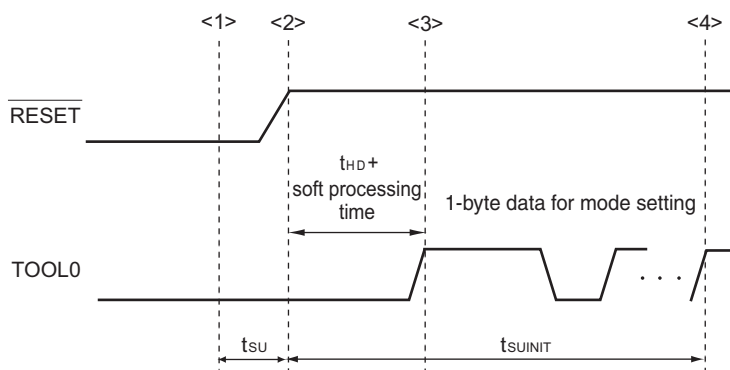

- <1> The low level is input to the TOOL0 pin.
- <2> The external reset is released (POR and LVD reset must be released before the external reset is released.).
- <3> The TOOL0 pin is set to the high level.
- <4> Setting of the flash memory programming mode by UART reception and complete the baud rate setting.

Remark t_{SUINIT}: Communication for the initial setting must be completed within 100 ms after a reset is released during this period.

t_{SU}: Time to release the external reset after the TOOL0 pin is set to the low level

t_{HD}: Time to hold the TOOL0 pin at the low level after the external reset is released (excluding the processing time of the firmware to control the flash memory)

3. ELECTRICAL SPECIFICATIONS (G: $T_A = -40$ to $+105^\circ\text{C}$)

This chapter describes the electrical specifications for the products "G: Industrial applications ($T_A = -40$ to $+105^\circ\text{C}$)".

- Cautions**
1. The RL78 microcontrollers have an on-chip debug function, which is provided for development and evaluation. Do not use the on-chip debug function in products designated for mass production, because the guaranteed number of rewritable times of the flash memory may be exceeded when this function is used, and product reliability therefore cannot be guaranteed. Renesas Electronics is not liable for problems occurring when the on-chip debug function is used.
 2. With products not provided with an EV_{DD} or EV_{SS} pin, replace EV_{DD} with V_{DD} , or replace EV_{SS} with V_{SS} .
 3. For derating with $T_A = +85$ to $+105^\circ\text{C}$, contact our Sales Division or the vender's sales division. Derating means the specified reduction in an operating parameter to improve reliability.

There are following differences between the products "G: Industrial applications ($T_A = -40$ to $+105^\circ\text{C}$)" and the products "A: Consumer applications, and G: Industrial applications ($T_A = -40$ to $+85^\circ\text{C}$)".

Parameter	Application	
	A: Consumer applications, G: Industrial applications (with $T_A = -40$ to $+85^\circ\text{C}$)	G: Industrial applications
Operating ambient temperature	$T_A = -40$ to $+85^\circ\text{C}$	$T_A = -40$ to $+105^\circ\text{C}$
Operating mode Operating voltage range	HS (high-speed main) mode: $2.7\text{ V} \leq V_{DD} \leq 5.5\text{ V}@1\text{ MHz to }32\text{ MHz}$ $2.4\text{ V} \leq V_{DD} \leq 5.5\text{ V}@1\text{ MHz to }16\text{ MHz}$ LS (low-speed main) mode: $1.8\text{ V} \leq V_{DD} \leq 5.5\text{ V}@1\text{ MHz to }8\text{ MHz}$ LV (low-voltage main) mode: $1.6\text{ V} \leq V_{DD} \leq 5.5\text{ V}@1\text{ MHz to }4\text{ MHz}$	HS (high-speed main) mode only: $2.7\text{ V} \leq V_{DD} \leq 5.5\text{ V}@1\text{ MHz to }32\text{ MHz}$ $2.4\text{ V} \leq V_{DD} \leq 5.5\text{ V}@1\text{ MHz to }16\text{ MHz}$
High-speed on-chip oscillator clock accuracy	$1.8\text{ V} \leq V_{DD} \leq 5.5\text{ V}$: $\pm 1.0\% @ T_A = -20$ to $+85^\circ\text{C}$ $\pm 1.5\% @ T_A = -40$ to -20°C $1.6\text{ V} \leq V_{DD} < 1.8\text{ V}$: $\pm 5.0\% @ T_A = -20$ to $+85^\circ\text{C}$ $\pm 5.5\% @ T_A = -40$ to -20°C	$2.4\text{ V} \leq V_{DD} \leq 5.5\text{ V}$: $\pm 2.0\% @ T_A = +85$ to $+105^\circ\text{C}$ $\pm 1.0\% @ T_A = -20$ to $+85^\circ\text{C}$ $\pm 1.5\% @ T_A = -40$ to -20°C
Serial array unit	UART CSI00: $f_{CLK}/2$ (supporting 16 Mbps), $f_{CLK}/4$ CSI01 Simplified I ² C communication	UART CSI00: $f_{CLK}/4$ CSI01 Simplified I ² C communication
IICA	Normal mode Fast mode Fast mode plus	Normal mode Fast mode
Voltage detector	Rise detection voltage: 1.67 V to 4.06 V (14 levels) Fall detection voltage: 1.63 V to 3.98 V (14 levels)	Rise detection voltage: 2.61 V to 4.06 V (8 levels) Fall detection voltage: 2.55 V to 3.98 V (8 levels)

Remark The electrical characteristics of the products G: Industrial applications ($T_A = -40$ to $+105^\circ\text{C}$) are different from those of the products "A: Consumer applications, and G: Industrial applications (only with $T_A = -40$ to $+85^\circ\text{C}$)". For details, refer to 3.1 to 3.11.

3.1 Absolute Maximum Ratings

Absolute Maximum Ratings (T_A = 25°C)

(1/3)

Parameter	Symbols	Conditions	Ratings	Unit
Supply voltage	V _{DD}	V _{DD} = EV _{DD}	-0.5 to +6.5	V
	EV _{DD}	V _{DD} = EV _{DD}	-0.5 to +6.5	V
	EV _{SS}		-0.5 to +0.3	V
REGC pin input voltage	V _{IREGC}	REGC	-0.3 to +2.8 and -0.3 to V _{DD} + 0.3 ^{Note 1}	V
Input voltage	V _{I1}	P10 to P17, P30 to P32, P40 to P43, P50 to P54, P70 to P74, P120, P125 to P127, P140 to P147	-0.3 to EV _{DD} + 0.3 and -0.3 to V _{DD} + 0.3 ^{Note 2}	V
	V _{I2}	P60, P61 (N-ch open-drain)	-0.3 to EV _{DD} + 0.3 and -0.3 to V _{DD} + 0.3 ^{Note 2}	V
	V _{I3}	P20, P21, P121 to P124, P137, EXCLK, EXCLKS, RESET	-0.3 to V _{DD} + 0.3 ^{Note 2}	V
Output voltage	V _{O1}	P10 to P17, P30 to P32, P40 to P43, P50 to P54, P60, P61, P70 to P74, P120, P125 to P127, P130, P140 to P147	-0.3 to EV _{DD} + 0.3 and -0.3 to V _{DD} + 0.3 ^{Note 2}	V
	V _{O2}	P20, P21	-0.3 to V _{DD} + 0.3 ^{Note 2}	V
Analog input voltage	V _{AI1}	ANI16 to ANI23	-0.3 to EV _{DD} + 0.3 and -0.3 to AV _{REF} (+) + 0.3 ^{Notes 2, 3}	V
	V _{AI2}	ANI0, ANI1	-0.3 to V _{DD} + 0.3 and -0.3 to AV _{REF} (+) + 0.3 ^{Notes 2, 3}	V

Notes 1. Connect the REGC pin to V_{SS} via a capacitor (0.47 to 1 μF). This value regulates the absolute maximum rating of the REGC pin. Do not use this pin with voltage applied to it.

2. Must be 6.5 V or lower.

3. Do not exceed AV_{REF}(+) + 0.3 V in case of A/D conversion target pin.

Caution Product quality may suffer if the absolute maximum rating is exceeded even momentarily for any parameter. That is, the absolute maximum ratings are rated values at which the product is on the verge of suffering physical damage, and therefore the product must be used under conditions that ensure that the absolute maximum ratings are not exceeded.

Remarks 1. Unless specified otherwise, the characteristics of alternate-function pins are the same as those of the port pins.

2. AV_{REF}(+) : + side reference voltage of the A/D converter.

3. V_{SS} : Reference voltage

Absolute Maximum Ratings (T_A = 25°C)**(2/3)**

Parameter	Symbols	Conditions	Ratings	Unit
LCD voltage	V _{L1}	V _{L1} voltage ^{Note 1}	-0.3 to +2.8 and -0.3 to V _{L4} + 0.3	V
	V _{L2}	V _{L2} voltage ^{Note 1}	-0.3 to V _{L4} + 0.3 ^{Note 2}	V
	V _{L3}	V _{L3} voltage ^{Note 1}	-0.3 to V _{L4} + 0.3 ^{Note 2}	V
	V _{L4}	V _{L4} voltage ^{Note 1}	-0.3 to +6.5	V
	V _{LCAP}	CAPL, CAPH voltage ^{Note 1}	-0.3 to V _{L4} + 0.3 ^{Note 2}	V
	V _{LOUT}	COM0 to COM7, SEG0 to SEG38, output voltage	External resistance division method Capacitor split method Internal voltage boosting method	-0.3 to V _{DD} + 0.3 ^{Note 2} -0.3 to V _{DD} + 0.3 ^{Note 2} -0.3 to V _{L4} + 0.3 ^{Note 2}

Notes 1. This value only indicates the absolute maximum ratings when applying voltage to the V_{L1}, V_{L2}, V_{L3}, and V_{L4} pins; it does not mean that applying voltage to these pins is recommended. When using the internal voltage boosting method or capacitance split method, connect these pins to V_{SS} via a capacitor (0.47 μF ± 30%) and connect a capacitor (0.47 μF ± 30%) between the CAPL and CAPH pins.

2. Must be 6.5 V or lower.

Caution Product quality may suffer if the absolute maximum rating is exceeded even momentarily for any parameter. That is, the absolute maximum ratings are rated values at which the product is on the verge of suffering physical damage, and therefore the product must be used under conditions that ensure that the absolute maximum ratings are not exceeded.

Remark V_{SS} : Reference voltage

Absolute Maximum Ratings (T_A = 25°C)**(3/3)**

Parameter	Symbols	Conditions		Ratings	Unit
Output current, high	I _{OH1}	Per pin	P10 to P17, P30 to P32, P40 to P43, P50 to P54, P70 to P74, P120, P125 to P127, P130, P140 to P147	-40	mA
		Total of all pins -170 mA	P10 to P14, P40 to P43, P120, P130, P140 to P147	-70	mA
			P15 to P17, P30 to P32, P50 to P54, P70 to P74, P125 to P127	-100	mA
	I _{OH2}	Per pin	P20, P21	-0.5	mA
		Total of all pins		-1	mA
Output current, low	I _{OL1}	Per pin	P10 to P17, P30 to P32, P40 to P43, P50 to P54, P60, P61, P70 to P74, P120, P125 to P127, P130, P140 to P147	40	mA
		Total of all pins 170 mA	P10 to P14, P40 to P43, P120, P130, P140 to P147	70	mA
			P15 to P17, P30 to P32, P50 to P54, P60, P61, P70 to P74, P125 to P127	100	mA
	I _{OL2}	Per pin	P20, P21	1	mA
		Total of all pins		2	mA
Operating ambient temperature	T _A	In normal operation mode		-40 to +105	°C
		In flash memory programming mode			
Storage temperature	T _{stg}			-65 to +150	°C

Caution Product quality may suffer if the absolute maximum rating is exceeded even momentarily for any parameter. That is, the absolute maximum ratings are rated values at which the product is on the verge of suffering physical damage, and therefore the product must be used under conditions that ensure that the absolute maximum ratings are not exceeded.

Remark Unless specified otherwise, the characteristics of alternate-function pins are the same as those of the port pins.

3.2 Oscillator Characteristics

3.2.1 X1, XT1 oscillator characteristics

(T_A = -40 to +105°C, 2.4 V ≤ EV_{DD} = V_{DD} ≤ 5.5 V, V_{SS} = EV_{SS} = 0 V)

Parameter	Resonator	Conditions	MIN.	TYP.	MAX.	Unit
X1 clock oscillation frequency (f _X) ^{Note}	Ceramic resonator/ crystal resonator	2.7 V ≤ V _{DD} ≤ 5.5 V	1.0		20.0	MHz
		2.4 V ≤ V _{DD} < 2.7 V	1.0		16.0	MHz
XT1 clock oscillation frequency (f _{XT}) ^{Note}	Crystal resonator		32	32.768	35	kHz

Note Indicates only permissible oscillator frequency ranges. Refer to **3.4 AC Characteristics** for instruction execution time. Request evaluation by the manufacturer of the oscillator circuit mounted on a board to check the oscillator characteristics.

Caution Since the CPU is started by the high-speed on-chip oscillator clock after a reset release, check the X1 clock oscillation stabilization time using the oscillation stabilization time counter status register (OSTC) by the user. Determine the oscillation stabilization time of the OSTC register and the oscillation stabilization time select register (OSTS) after sufficiently evaluating the oscillation stabilization time with the resonator to be used.

3.2.2 On-chip oscillator characteristics

(T_A = -40 to +105°C, 2.4 V ≤ EV_{DD} = V_{DD} ≤ 5.5 V, V_{SS} = EV_{SS} = 0 V)

Oscillators	Parameters	Conditions		MIN.	TYP.	MAX.	Unit
High-speed on-chip oscillator clock frequency ^{Notes 1, 2}	f _{IH}			1		24	MHz
High-speed on-chip oscillator clock frequency accuracy		-20 to +85°C	2.4 V ≤ V _{DD} ≤ 5.5 V	-1		+1	%
		-40 to -20°C	2.4 V ≤ V _{DD} ≤ 5.5 V	-1.5		+1.5	%
		+85 to +105°C	2.4 V ≤ V _{DD} ≤ 5.5 V	-2.0		+2.0	%
Low-speed on-chip oscillator clock frequency	f _{IL}				15		kHz
Low-speed on-chip oscillator clock frequency accuracy				-15		+15	%

Notes 1. High-speed on-chip oscillator frequency is selected by bits 0 to 3 of option byte (000C2H) and bits 0 to 2 of HOCODIV register.

2. This indicates the oscillator characteristics only. Refer to **3.4 AC Characteristics** for instruction execution time.

3.3 DC Characteristics

3.3.1 Pin characteristics

(T_A = -40 to +105°C, 2.4 V ≤ EV_{DD} = V_{DD} ≤ 5.5 V, V_{SS} = EV_{SS} = 0 V)

(1/5)

Items	Symbol	Conditions	MIN.	TYP.	MAX.	Unit	
Output current, high ^{Note 1}	I _{OH1}	Per pin for P10 to P17, P30 to P32, P40 to P43, P50 to P54, P70 to P74, P120, P125 to P127, P130, P140 to P147			-3.0 ^{Note 2}	mA	
		Total of P10 to P14, P40 to P43, P120, P130, P140 to P147 (When duty = 70% ^{Note 3})	4.0 V ≤ EV _{DD} ≤ 5.5 V			-30.0	mA
			2.7 V ≤ EV _{DD} < 4.0 V			-8.0	mA
			2.4 V ≤ EV _{DD} < 2.7 V			-4.0	mA
		Total of P15 to P17, P30 to P32, P50 to P54, P70 to P74, P125 to P127 (When duty = 70% ^{Note 3})	4.0 V ≤ EV _{DD} ≤ 5.5 V			-30.0	mA
			2.7 V ≤ EV _{DD} < 4.0 V			-15.0	mA
			2.4 V ≤ EV _{DD} < 2.7 V			-8.0	mA
	Total of all pins (When duty = 70% ^{Note 3})				-60.0	mA	
	I _{OH2}	P20, P21	Per pin			-0.1	mA
			Total of all pins	2.4 V ≤ V _{DD} ≤ 5.5 V			-0.2

Notes 1. Value of current at which the device operation is guaranteed even if the current flows from the V_{DD} and EV_{DD} pins to an output pin.

2. Do not exceed the total current value.

3. Specification under conditions where the duty factor ≤ 70%.

The output current value that has changed to the duty factor > 70% the duty ratio can be calculated with the following expression (when changing the duty factor from 70% to n%).

- Total output current of pins = (I_{OH} × 0.7)/(n × 0.01)

<Example> Where n = 80% and I_{OH} = -30.0 mA

$$\text{Total output current of pins} = (-30.0 \times 0.7)/(80 \times 0.01) \cong -26.25 \text{ mA}$$

However, the current that is allowed to flow into one pin does not vary depending on the duty factor. A current higher than the absolute maximum rating must not flow into one pin.

Caution P10, P12, P15, and P17 do not output high level in N-ch open-drain mode.

Remark Unless specified otherwise, the characteristics of alternate-function pins are the same as those of the port pins.

(T_A = -40 to +105°C, 2.4 V ≤ EV_{DD} = V_{DD} ≤ 5.5 V, V_{SS} = EV_{SS} = 0 V)

(2/5)

Items	Symbol	Conditions		MIN.	TYP.	MAX.	Unit	
Output current, I _{OL} ^{Note 1}	I _{OL1}	Per pin for P10 to P17, P30 to P32, P40 to P43, P50 to P54, P70 to P74, P120, P125 to P127, P130, P140 to P147				8.5 ^{Note 2}	mA	
		Per pin for P60, P61				15.0 ^{Note 2}	mA	
		Total of P10 to P14, P40 to P43, P120, P130, P140 to P147 (When duty = 70% ^{Note 3})	4.0 V ≤ EV _{DD} ≤ 5.5 V			40.0	mA	
			2.7 V ≤ EV _{DD} < 4.0 V			15.0	mA	
			2.4 V ≤ EV _{DD} < 2.7 V			9.0	mA	
		Total of P15 to P17, P30 to P32, P50 to P54, P60, P61, P70 to P74, P125 to P127 (When duty = 70% ^{Note 3})	4.0 V ≤ EV _{DD} ≤ 5.5 V			40.0	mA	
			2.7 V ≤ EV _{DD} < 4.0 V			35.0	mA	
	2.4 V ≤ EV _{DD} < 2.7 V				20.0	mA		
	Total of all pins (When duty = 70% ^{Note 3})						80.0	mA
	I _{OL2}	P20, P21	Per pin				0.4	mA
Total of all pins			2.4 V ≤ V _{DD} ≤ 5.5 V			0.8	mA	

- Notes**
- Value of current at which the device operation is guaranteed even if the current flows from the V_{DD} and EV_{DD} pins to an output pin.
 - Do not exceed the total current value.
 - Specification under conditions where the duty factor ≤ 70%.

The output current value that has changed to the duty factor > 70% the duty ratio can be calculated with the following expression (when changing the duty factor from 70% to n%).

- Total output current of pins = (I_{OL} × 0.7)/(n × 0.01)

<Example> Where n = 80% and I_{OL} = 40.0 mA

$$\text{Total output current of pins} = (40.0 \times 0.7)/(80 \times 0.01) \cong 35.0 \text{ mA}$$

However, the current that is allowed to flow into one pin does not vary depending on the duty factor. A current higher than the absolute maximum rating must not flow into one pin.

Remark Unless specified otherwise, the characteristics of alternate-function pins are the same as those of the port pins.

(T_A = -40 to +105°C, 2.4 V ≤ EV_{DD} = V_{DD} ≤ 5.5 V, V_{SS} = EV_{SS} = 0 V)

(3/5)

Items	Symbol	Conditions	MIN.	TYP.	MAX.	Unit	
Input voltage, high	V _{IH1}	P10 to P17, P30 to P32, P40 to P43, P50 to P54, P70 to P74, P120, P125 to P127, P140 to P147	Normal input buffer	0.8EV _{DD}		EV _{DD}	V
	V _{IH2}	P10, P11, P15, P16	TTL input buffer 4.0 V ≤ EV _{DD} ≤ 5.5 V	2.2		EV _{DD}	V
			TTL input buffer 3.3 V ≤ EV _{DD} < 4.0 V	2.0		EV _{DD}	V
			TTL input buffer 2.4 V ≤ EV _{DD} < 3.3 V	1.50		EV _{DD}	V
	V _{IH3}	P20, P21		0.7V _{DD}		V _{DD}	V
	V _{IH4}	P60, P61		0.7EV _{DD}		EV _{DD}	V
	V _{IH5}	P121 to P124, P137, EXCLK, EXCLKS, $\overline{\text{RESET}}$		0.8V _{DD}		V _{DD}	V
Input voltage, low	V _{IL1}	P10 to P17, P30 to P32, P40 to P43, P50 to P54, P70 to P74, P120, P125 to P127, P140 to P147	Normal input buffer	0		0.2EV _{DD}	V
	V _{IL2}	P10, P11, P15, P16	TTL input buffer 4.0 V ≤ EV _{DD} ≤ 5.5 V	0		0.8	V
			TTL input buffer 3.3 V ≤ EV _{DD} < 4.0 V	0		0.5	V
			TTL input buffer 2.4 V ≤ EV _{DD} < 3.3 V	0		0.32	V
	V _{IL3}	P20, P21		0		0.3V _{DD}	V
	V _{IL4}	P60, P61		0		0.3EV _{DD}	V
	V _{IL5}	P121 to P124, P137, EXCLK, EXCLKS, $\overline{\text{RESET}}$		0		0.2V _{DD}	V

Caution The maximum value of V_{IH} of pins P10, P12, P15, and P17 is EV_{DD}, even in the N-ch open-drain mode.

Remark Unless specified otherwise, the characteristics of alternate-function pins are the same as those of the port pins.

(T_A = -40 to +105°C, 2.4 V ≤ EV_{DD} = V_{DD} ≤ 5.5 V, V_{SS} = EV_{SS} = 0 V)

(4/5)

Items	Symbol	Conditions	MIN.	TYP.	MAX.	Unit
Output voltage, high	V _{OH1}	P10 to P17, P30 to P32, P40 to P43, P50 to P54, P70 to P74, P120, P125 to P127, P130, P140 to P147	4.0 V ≤ EV _{DD} ≤ 5.5 V, I _{OH1} = -3.0 mA	EV _{DD} - 0.7		V
			2.7 V ≤ EV _{DD} ≤ 5.5 V, I _{OH1} = -2.0 mA	EV _{DD} - 0.6		V
			2.4 V ≤ EV _{DD} ≤ 5.5 V, I _{OH1} = -1.5 mA	EV _{DD} - 0.5		V
	V _{OH2}	P20, P21	2.4 V ≤ V _{DD} ≤ 5.5 V, I _{OH2} = -100 μA	V _{DD} - 0.5		V
Output voltage, low	V _{OL1}	P10 to P17, P30 to P32, P40 to P43, P50 to P54, P70 to P74, P120, P125 to P127, P130, P140 to P147	4.0 V ≤ EV _{DD} ≤ 5.5 V, I _{OL1} = 8.5 mA		0.7	V
			2.7 V ≤ EV _{DD} ≤ 5.5 V, I _{OL1} = 3.0 mA		0.6	V
			2.7 V ≤ EV _{DD} ≤ 5.5 V, I _{OL1} = 1.5 mA		0.4	V
			2.4 V ≤ EV _{DD} ≤ 5.5 V, I _{OL1} = 0.6 mA		0.4	V
	V _{OL2}	P20, P21	2.4 V ≤ V _{DD} ≤ 5.5 V, I _{OL2} = 400 μA		0.4	V
	V _{OL3}	P60, P61	4.0 V ≤ EV _{DD} ≤ 5.5 V, I _{OL3} = 15.0 mA		2.0	V
			4.0 V ≤ EV _{DD} ≤ 5.5 V, I _{OL3} = 5.0 mA		0.4	V
			2.7 V ≤ EV _{DD} ≤ 5.5 V, I _{OL3} = 3.0 mA		0.4	V
			2.4 V ≤ EV _{DD} ≤ 5.5 V, I _{OL3} = 2.0 mA		0.4	V

Caution P10, P12, P15, and P17 do not output high level in N-ch open-drain mode.

Remark Unless specified otherwise, the characteristics of alternate-function pins are the same as those of the port pins.

(T_A = -40 to +105°C, 2.4 V ≤ EV_{DD} = V_{DD} ≤ 5.5 V, V_{SS} = EV_{SS} = 0 V)

(5/5)

Items	Symbol	Conditions		MIN.	TYP.	MAX.	Unit	
Input leakage current, high	I _{LIH1}	P10 to P17, P30 to P32, P40 to P43, P50 to P54, P60, P61, P70 to P74, P120, P125 to P127, P140 to P147	V _I = EV _{DD}			1	μA	
	I _{LIH2}	P20, P21, P137, RESET	V _I = V _{DD}			1	μA	
	I _{LIH3}	P121 to P124 (X1, X2, XT1, XT2, EXCLK, EXCLKS)	V _I = V _{DD}	In input port or external clock input			1	μA
				In resonator connection			10	μA
Input leakage current, low	I _{LIL1}	P10 to P17, P30 to P32, P40 to P43, P50 to P54, P60, P61, P70 to P74, P120, P125 to P127, P140 to P147	V _I = EV _{SS}			-1	μA	
	I _{LIL2}	P20, P21, P137, RESET	V _I = V _{SS}			-1	μA	
	I _{LIL3}	P121 to P124 (X1, X2, XT1, XT2, EXCLK, EXCLKS)	V _I = V _{SS}	In input port or external clock input			-1	μA
				In resonator connection			-10	μA
On-chip pll-up resistance	R _{U1}	V _I = EV _{SS}	SEGxx port					
			2.4 V ≤ EV _{DD} = V _{DD} ≤ 5.5 V	10	20	100	kΩ	
	R _{U2}		Ports other than above (Except for P60, P61, and P130)	10	20	100	kΩ	

Remark Unless specified otherwise, the characteristics of alternate-function pins are the same as those of the port pins.

3.3.2 Supply current characteristics

(T_A = -40 to +105°C, 2.4 V ≤ EV_{DD} = V_{DD} ≤ 5.5 V, V_{SS} = EV_{SS} = 0 V)

(1/3)

Parameter	Symbol	Conditions				MIN.	TYP.	MAX.	Unit	
Supply current Note 1	I _{DD1}	Operating mode	HS (high-speed main) mode Note 5	f _{IH} = 24 MHz Note 3	Basic operation	V _{DD} = 5.0 V		1.5		mA
						V _{DD} = 3.0 V		1.5		mA
					Normal operation	V _{DD} = 5.0 V		3.3	5.3	mA
					V _{DD} = 3.0 V		3.3	5.3	mA	
				Normal operation	V _{DD} = 5.0 V		2.5	3.9	mA	
					V _{DD} = 3.0 V		2.5	3.9	mA	
			HS (high-speed main) mode Note 5	f _{MX} = 20 MHz Note 2, V _{DD} = 5.0 V	Normal operation	Square wave input		2.8	4.7	mA
						Resonator connection		3.0	4.8	mA
				f _{MX} = 20 MHz Note 2, V _{DD} = 3.0 V	Normal operation	Square wave input		2.8	4.7	mA
						Resonator connection		3.0	4.8	mA
		f _{MX} = 10 MHz Note 2, V _{DD} = 5.0 V		Normal operation	Square wave input		1.8	2.8	mA	
					Resonator connection		1.8	2.8	mA	
		f _{MX} = 10 MHz Note 2, V _{DD} = 3.0 V		Normal operation	Square wave input		1.8	2.8	mA	
					Resonator connection		1.8	2.8	mA	
		Subsystem clock operation	f _{SUB} = 32.768 kHz Note 4 T _A = -40°C	Normal operation	Square wave input		3.5	4.9	μA	
					Resonator connection		3.6	5.0	μA	
			f _{SUB} = 32.768 kHz Note 4 T _A = +25°C	Normal operation	Square wave input		3.6	4.9	μA	
					Resonator connection		3.7	5.0	μA	
			f _{SUB} = 32.768 kHz Note 4 T _A = +50°C	Normal operation	Square wave input		3.7	5.5	μA	
					Resonator connection		3.8	5.6	μA	
f _{SUB} = 32.768 kHz Note 4 T _A = +70°C	Normal operation		Square wave input		3.8	6.3	μA			
			Resonator connection		3.9	6.4	μA			
f _{SUB} = 32.768 kHz Note 4 T _A = +85°C	Normal operation	Square wave input		4.1	7.7	μA				
		Resonator connection		4.2	7.8	μA				
f _{SUB} = 32.768 kHz Note 4 T _A = +105°C	Normal operation	Square wave input		6.4	19.7	μA				
		Resonator connection		6.5	19.8	μA				

(Notes and Remarks are listed on the next page.)

- Notes**
1. Total current flowing into V_{DD} and EV_{DD}, including the input leakage current flowing when the level of the input pin is fixed to V_{DD}, EV_{DD} or V_{SS}, EV_{SS}. The values below the MAX. column include the peripheral operation current. However, not including the current flowing into the A/D converter, LVD circuit, I/O port, and on-chip pull-up/pull-down resistors and the current flowing during data flash rewrite.
 2. When high-speed on-chip oscillator and subsystem clock are stopped.
 3. When high-speed system clock and subsystem clock are stopped.
 4. When high-speed on-chip oscillator and high-speed system clock are stopped. When AMPHS1 = 1 (Ultra-low power consumption oscillation). However, not including the current flowing into the RTC, 12-bit interval timer, watchdog timer, and LCD controller/driver.
 5. Relationship between operation voltage width, operation frequency of CPU and operation mode is as below.
HS (high-speed main) mode: $2.7\text{ V} \leq V_{DD} \leq 5.5\text{ V}@1\text{ MHz to }24\text{ MHz}$
 $2.4\text{ V} \leq V_{DD} \leq 5.5\text{ V}@1\text{ MHz to }16\text{ MHz}$

- Remarks**
1. f_{MX}: High-speed system clock frequency (X1 clock oscillation frequency or external main system clock frequency)
 2. f_{IH}: High-speed on-chip oscillator clock frequency
 3. f_{SUB}: Subsystem clock frequency (XT1 clock oscillation frequency)
 4. Except subsystem clock operation, temperature condition of the TYP. value is T_A = 25°C

(T_A = -40 to +105°C, 2.4 V ≤ EV_{DD} = V_{DD} ≤ 5.5 V, V_{SS} = EV_{SS} = 0 V)

(2/3)

Parameter	Symbol	Conditions				MIN.	TYP.	MAX.	Unit	
Supply current Note 1	I _{DD2} Note 2	HALT mode	HS (high-speed main) mode Note 7	f _{IH} = 24 MHz Note 4	V _{DD} = 5.0 V		0.44	2.3	mA	
					V _{DD} = 3.0 V		0.44	2.3	mA	
				f _{IH} = 16 MHz Note 4	V _{DD} = 5.0 V		0.40	1.7	mA	
					V _{DD} = 3.0 V		0.40	1.7	mA	
				HS (high-speed main) mode Note 7	f _{MX} = 20 MHz Note 3, V _{DD} = 5.0 V	Square wave input		0.28	1.9	mA
						Resonator connection		0.45	2.0	mA
			f _{MX} = 20 MHz Note 3, V _{DD} = 3.0 V		Square wave input		0.28	1.9	mA	
					Resonator connection		0.45	2.0	mA	
			f _{MX} = 10 MHz Note 3, V _{DD} = 5.0 V		Square wave input		0.19	1.02	mA	
					Resonator connection		0.26	1.10	mA	
			Subsystem clock operation	f _{SUB} = 32.768 kHz Note 5 T _A = -40°C	Square wave input		0.31	0.57	μA	
					Resonator connection		0.50	0.76	μA	
				f _{SUB} = 32.768 kHz Note 5 T _A = +25°C	Square wave input		0.37	0.57	μA	
					Resonator connection		0.56	0.76	μA	
	f _{SUB} = 32.768 kHz Note 5 T _A = +50°C	Square wave input			0.46	1.17	μA			
		Resonator connection			0.65	1.36	μA			
	f _{SUB} = 32.768 kHz Note 5 T _A = +70°C	Square wave input			0.57	1.97	μA			
		Resonator connection			0.76	2.16	μA			
	f _{SUB} = 32.768 kHz Note 5 T _A = +85°C	Square wave input		0.85	3.37	μA				
		Resonator connection		1.04	3.56	μA				
f _{SUB} = 32.768 kHz Note 5 T _A = +105°C	Square wave input		3.04	15.37	μA					
	Resonator connection		3.23	15.56	μA					
I _{DD3} Note 6	STOP mode Note 8	T _A = -40°C				0.17	0.50	μA		
		T _A = +25°C				0.23	0.50	μA		
		T _A = +50°C				0.32	1.10	μA		
		T _A = +70°C				0.43	1.90	μA		
		T _A = +85°C				0.71	3.30	μA		
		T _A = +105°C				2.90	15.30	μA		

(Notes and Remarks are listed on the next page.)

- Notes**
1. Total current flowing into V_{DD} and EV_{DD}, including the input leakage current flowing when the level of the input pin is fixed to V_{DD}, EV_{DD} or V_{SS}, EV_{SS}. The values below the MAX. column include the peripheral operation current. However, not including the current flowing into the A/D converter, LVD circuit, I/O port, and on-chip pull-up/pull-down resistors and the current flowing during data flash rewrite.
 2. During HALT instruction execution by flash memory.
 3. When high-speed on-chip oscillator and subsystem clock are stopped.
 4. When high-speed system clock and subsystem clock are stopped.
 5. When high-speed on-chip oscillator and high-speed system clock are stopped. When RTCLPC = 1 and setting ultra-low current consumption (AMPHS1 = 1). The current flowing into the RTC is included. However, not including the current flowing into the 12-bit interval timer, watchdog timer, and LCD controller/driver.
 6. Not including the current flowing into the RTC, 12-bit interval timer, and watchdog timer.
 7. Relationship between operation voltage width, operation frequency of CPU and operation mode is as below.
HS (high-speed main) mode: $2.7\text{ V} \leq V_{DD} \leq 5.5\text{ V}@1\text{ MHz to }24\text{ MHz}$
 $2.4\text{ V} \leq V_{DD} \leq 5.5\text{ V}@1\text{ MHz to }16\text{ MHz}$
 8. Regarding the value for current operate the subsystem clock in STOP mode, refer to that in HALT mode.

- Remarks**
1. f_{MX}: High-speed system clock frequency (X1 clock oscillation frequency or external main system clock frequency)
 2. f_{IH}: High-speed on-chip oscillator clock frequency
 3. f_{SUB}: Subsystem clock frequency (XT1 clock oscillation frequency)
 4. Except subsystem clock operation and STOP mode, temperature condition of the TYP. value is T_A = 25°C

(T_A = -40 to +105°C, 2.4 V ≤ EV_{DD} = V_{DD} ≤ 5.5 V, V_{SS} = EV_{SS} = 0 V)

(3/3)

Parameter	Symbol	Conditions		MIN.	TYP.	MAX.	Unit
Low-speed on-chip oscillator operating current	I _{FIL} ^{Note 1}				0.20		μA
RTC operating current	I _{RTC} ^{Notes 1, 2, 3}	f _{MAIN} is stopped			0.08		μA
12-bit interval timer current	I _{IT} ^{Notes 1, 2, 4}				0.08		μA
Watchdog timer operating current	I _{WDT} ^{Notes 1, 2, 5}	f _{IL} = 15 kHz			0.24		μA
A/D converter operating current	I _{ADC} ^{Notes 1, 6}	When conversion at maximum speed	Normal mode, AV _{REFP} = V _{DD} = 5.0 V		1.3	1.7	mA
			Low voltage mode, AV _{REFP} = V _{DD} = 3.0 V		0.5	0.7	mA
A/D converter reference voltage current	I _{ADREF} ^{Note 1}				75.0		μA
Temperature sensor operating current	I _{TMPS} ^{Note 1}				75.0		μA
LVD operating current	I _{LVD} ^{Notes 1, 7}				0.08		μA
Self-programming operating current	I _{FSP} ^{Notes 1, 9}				2.50	12.20	mA
BGO operating current	I _{BGO} ^{Notes 1, 8}				2.50	12.20	mA
LCD operating current	I _{LCD1} ^{Notes 11, 12}	External resistance division method	V _{DD} = EV _{DD} = 5.0 V V _{L4} = 5.0 V		0.04	0.20	μA
			V _{DD} = EV _{DD} = 5.0 V V _{L4} = 5.1 V (VLCD = 12H)		1.12	3.70	μA
	I _{LCD2} ^{Note 11}	Internal voltage boosting method	V _{DD} = EV _{DD} = 3.0 V V _{L4} = 3.0 V (VLCD = 04H)		0.63	2.20	μA
			V _{DD} = EV _{DD} = 3.0 V V _{L4} = 3.0 V		0.12	0.50	μA
I _{LCD3} ^{Note 11}	Capacitor split method	V _{DD} = EV _{DD} = 3.0 V V _{L4} = 3.0 V		0.12	0.50	μA	
SNOOZE operating current	I _{SNOZ} ^{Note 1}	ADC operation	The mode is performed ^{Note 10}		0.50	1.10	mA
			The A/D conversion operations are performed, Low voltage mode, AV _{REFP} = V _{DD} = 3.0 V		1.20	2.04	mA
		CSI/UART operation		0.70	1.54	mA	

(Notes and Remarks are listed on the next page.)

- Notes**
1. Current flowing to V_{DD} .
 2. When high speed on-chip oscillator and high-speed system clock are stopped.
 3. Current flowing only to the real-time clock (RTC) (excluding the operating current of the low-speed on-chip oscillator and the XT1 oscillator). The supply current of the RL78 microcontrollers is the sum of the values of either I_{DD1} or I_{DD2} , and I_{RTC} , when the real-time clock operates in operation mode or HALT mode. When the low-speed on-chip oscillator is selected, I_{FIL} should be added. I_{DD2} subsystem clock operation includes the operational current of the real-time clock.
 4. Current flowing only to the 12-bit interval timer (excluding the operating current of the low-speed on-chip oscillator and the XT1 oscillator). The supply current of the RL78 microcontrollers is the sum of the values of either I_{DD1} or I_{DD2} , and I_{IT} , when the 12-bit interval timer operates in operation mode or HALT mode. When the low-speed on-chip oscillator is selected, I_{FIL} should be added.
 5. Current flowing only to the watchdog timer (including the operating current of the low-speed on-chip oscillator). The supply current of the RL78 microcontrollers is the sum of I_{DD1} , I_{DD2} or I_{DD3} and I_{WDT} when the watchdog timer is in operation.
 6. Current flowing only to the A/D converter. The supply current of the RL78 microcontrollers is the sum of I_{DD1} or I_{DD2} and I_{ADC} when the A/D converter operates in an operation mode or the HALT mode.
 7. Current flowing only to the LVD circuit. The supply current of the RL78 microcontrollers is the sum of I_{DD1} , I_{DD2} or I_{DD3} and I_{LVD} when the LVD circuit is in operation.
 8. Current flowing only during data flash rewrite.
 9. Current flowing only during self programming.
 10. For shift time to the SNOOZE mode.
 11. Current flowing only to the LCD controller/driver. The supply current value of the RL78 microcontrollers is the sum of the LCD operating current (I_{LCD1} , I_{LCD2} or I_{LCD3}) to the supply current (I_{DD1} or I_{DD2}) when the LCD controller/driver operates in an operation mode or HALT mode. Not including the current that flows through the LCD panel.
The TYP. value and MAX. value are following conditions.
 - When f_{SUB} is selected for system clock, LCD clock = 128 Hz (LCDC0 = 07H)
 - 4-Time-Slice, 1/3 Bias Method
 12. Not including the current that flows through the external divider resistor when the external resistance division method is used.

- Remarks**
1. f_{IL} : Low-speed on-chip oscillator clock frequency
 2. f_{SUB} : Subsystem clock frequency (XT1 clock oscillation frequency)
 3. f_{CLK} : CPU/peripheral hardware clock frequency
 4. Temperature condition of the TYP. value is $T_A = 25^\circ\text{C}$

3.4 AC Characteristics

3.4.1 Basic operation

(T_A = -40 to +105°C, 2.4 V ≤ EV_{DD} = V_{DD} ≤ 5.5 V, V_{SS} = EV_{SS} = 0 V)

Items	Symbol	Conditions		MIN.	TYP.	MAX.	Unit	
Instruction cycle (minimum instruction execution time)	T _{cy}	Main system clock (f _{MAIN}) operation	HS (high-speed main) mode	2.7 V ≤ V _{DD} ≤ 5.5 V	0.04167		1	μs
				2.4 V ≤ V _{DD} < 2.7 V	0.0625		1	μs
		Subsystem clock (f _{SUB}) operation		2.4 V ≤ V _{DD} ≤ 5.5 V	28.5	30.5	31.3	μs
		In the self programming mode	HS (high-speed main) mode	2.7 V ≤ V _{DD} ≤ 5.5 V	0.04167		1	μs
	2.4 V ≤ V _{DD} < 2.7 V		0.0625		1	μs		
External system clock frequency	f _{EX}	2.7 V ≤ V _{DD} ≤ 5.5 V		1.0		20.0	MHz	
		2.4 V ≤ V _{DD} < 2.7 V		1.0		16.0	MHz	
	f _{EXS}			32		35	kHz	
External system clock input high-level width, low-level width	t _{EXH} , t _{EXL}	2.7 V ≤ V _{DD} ≤ 5.5 V		24			ns	
		2.4 V ≤ V _{DD} < 2.7 V		30			ns	
	t _{EXHS} , t _{EXLS}			13.7			μs	
TI00 to TI07 input high-level width, low-level width	t _{TIH} , t _{TIL}			1/f _{MCK} +10			ns	
TO00 to TO07 output frequency	f _{TO}	HS (high-speed main) mode	4.0 V ≤ EV _{DD} ≤ 5.5 V			16	MHz	
			2.7 V ≤ EV _{DD} < 4.0 V			8	MHz	
			2.4 V ≤ EV _{DD} < 2.7 V			4	MHz	
PCLBUZ0, PCLBUZ1 output frequency	f _{PCL}	HS (high-speed main) mode	4.0 V ≤ EV _{DD} ≤ 5.5 V			16	MHz	
			2.7 V ≤ EV _{DD} < 4.0 V			8	MHz	
			2.4 V ≤ EV _{DD} < 2.7 V			4	MHz	
Interrupt input high-level width, low-level width	t _{INTH} , t _{INTL}	INTP0	2.4 V ≤ V _{DD} ≤ 5.5 V	1			μs	
		INTP1 to INTP7	2.4 V ≤ V _{DD} ≤ 5.5 V	1			μs	
Key interrupt input low-level width	t _{KR}	KR0 to KR3	2.4 V ≤ EV _{DD} ≤ 5.5 V	250			ns	
RESET low-level width	t _{RSL}			10			μs	

Remark f_{MCK}: Timer array unit operation clock frequency

(Operation clock to be set by the CKS0n bit of timer mode register 0n (TMR0n).

n: Channel number (n = 0 to 7))

Minimum Instruction Execution Time during Main System Clock Operation

T_{CY} vs V_{DD} (HS (high-speed main) mode)

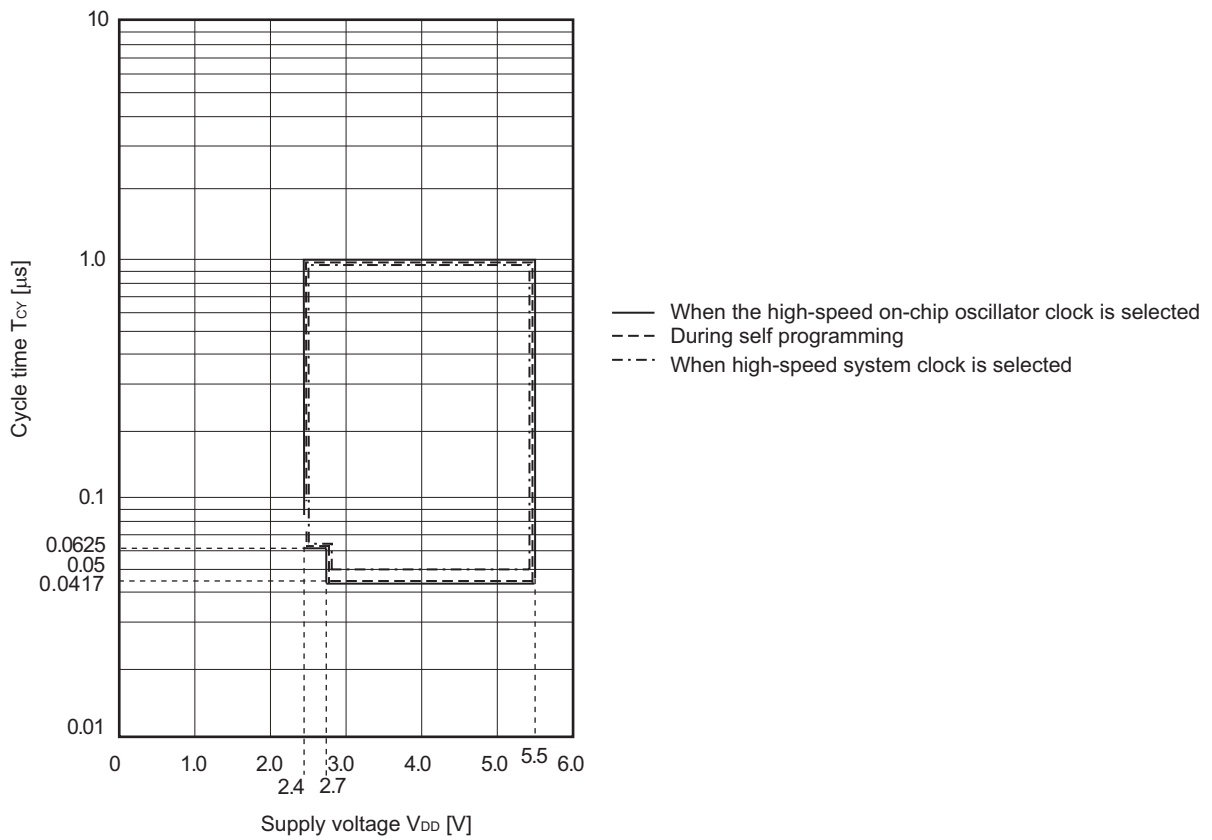

AC Timing Test Points

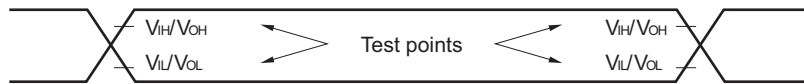

External System Clock Timing

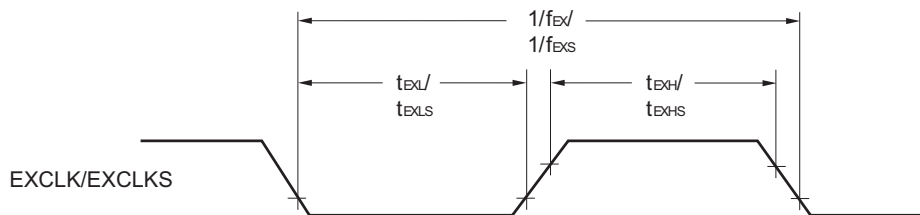

TI/TO Timing

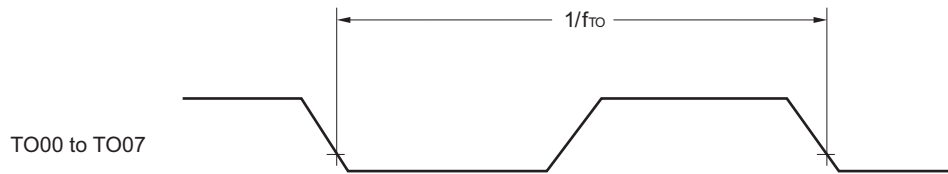
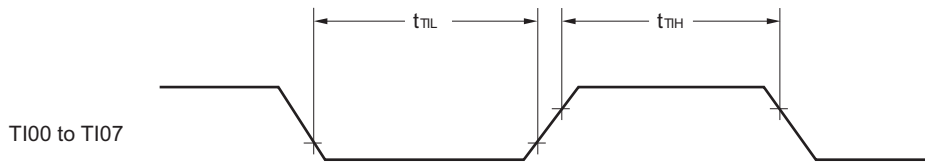

Interrupt Request Input Timing

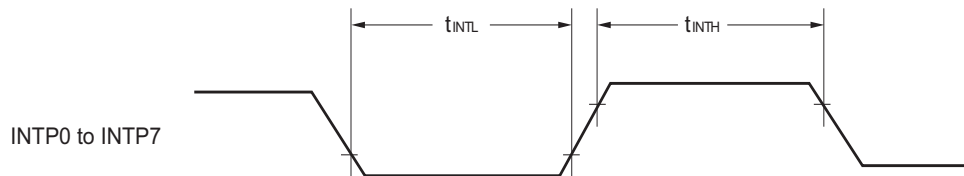

Key Interrupt Input Timing

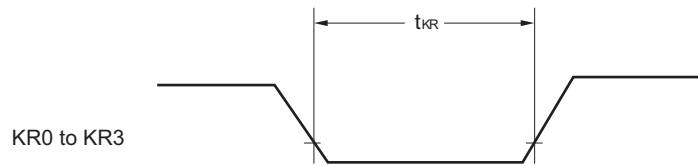

RESET Input Timing

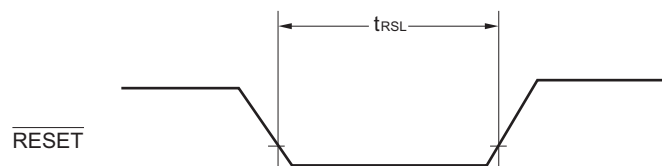

3.5 Peripheral Functions Characteristics

AC Timing Test Points



3.5.1 Serial array unit

(1) During communication at same potential (UART mode)

(T_A = -40 to +105°C, 2.4 V ≤ EV_{DD} = V_{DD} ≤ 5.5 V, V_{SS} = EV_{SS} = 0 V)

Parameter	Symbol	Conditions	HS (high-speed main) Mode		Unit
			MIN.	MAX.	
Transfer rate ^{Note 1}		Theoretical value of the maximum transfer rate f _{MCK} = f _{CLK} ^{Note 2}		f _{MCK} /12	bps
				2.0	Mbps

Notes 1. Transfer rate in the SNOOZE mode is 4800 bps only.

2. The maximum operating frequencies of the CPU/peripheral hardware clock (f_{CLK}) are:

HS (high-speed main) mode: 24 MHz (2.7 V ≤ V_{DD} ≤ 5.5 V)

16 MHz (2.4 V ≤ V_{DD} ≤ 5.5 V)

Caution Select the normal input buffer for the Rx_{Dq} pin and the normal output mode for the Tx_{Dq} pin by using port input mode register g (PIMg) and port output mode register g (POMg).

UART mode connection diagram (during communication at same potential)

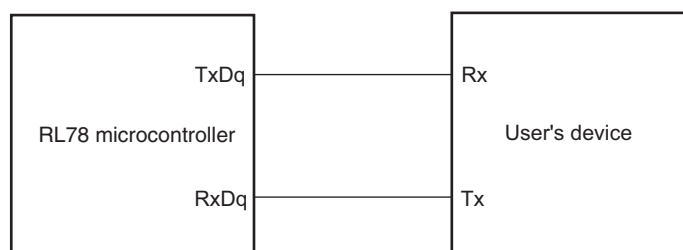

UART mode bit width (during communication at same potential) (reference)

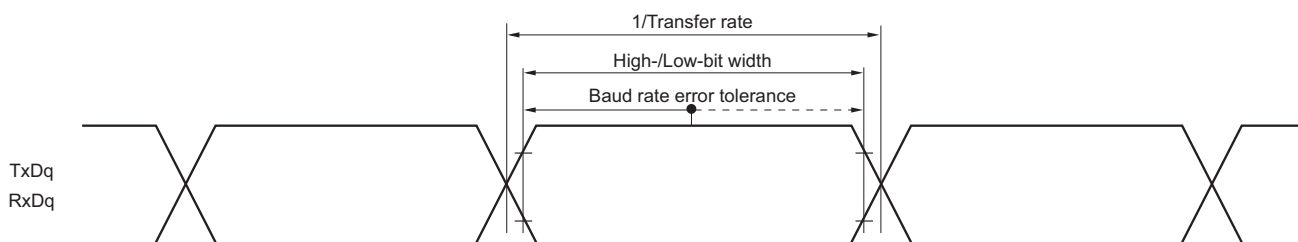

Remarks 1. q: UART number (q = 0), g: PIM and POM number (g = 1)

2. f_{MCK}: Serial array unit operation clock frequency

(Operation clock to be set by the serial clock select register m (SPSm) and the CKSmn bit of serial mode register mn (SMRmn). m: Unit number, n: Channel number (mn = 00, 01))

(2) During communication at same potential (CSI mode) (master mode, SCKp... internal clock output)**(T_A = -40 to +105°C, 2.4 V ≤ EV_{DD} = V_{DD} ≤ 5.5 V, V_{SS} = EV_{SS} = 0 V)**

Parameter	Symbol	Conditions	HS (high-speed main) Mode		Unit
			MIN.	MAX.	
SCKp cycle time	t _{KCY1}	2.7 V ≤ EV _{DD} ≤ 5.5 V	334 ^{Note 1}		ns
		2.4 V ≤ EV _{DD} ≤ 5.5 V	500 ^{Note 1}		ns
SCKp high-/low-level width	t _{KH1} , t _{KL1}	4.0 V ≤ EV _{DD} ≤ 5.5 V	t _{KCY1} /2 - 24		ns
		2.7 V ≤ EV _{DD} ≤ 5.5 V	t _{KCY1} /2 - 36		ns
		2.4 V ≤ EV _{DD} ≤ 5.5 V	t _{KCY1} /2 - 76		ns
Slp setup time (to SCKp↑) ^{Note 2}	t _{SIK1}	2.7 V ≤ EV _{DD} ≤ 5.5 V	66		ns
		2.4 V ≤ EV _{DD} ≤ 5.5 V	113		ns
Slp hold time (from SCKp↑) ^{Note 3}	t _{KSI1}	2.4 V ≤ EV _{DD} ≤ 5.5 V	38		ns
Delay time from SCKp↓ to SOp output ^{Note 4}	t _{KSO1}	C = 30 pF ^{Note 5}	2.4 V ≤ EV _{DD} ≤ 5.5 V	50	ns

Notes 1. Set a cycle of 4/f_{MCK} or longer.2. When DAP_{mn} = 0 and CKP_{mn} = 0, or DAP_{mn} = 1 and CKP_{mn} = 1. The Slp setup time becomes “to SCKp↓” when DAP_{mn} = 0 and CKP_{mn} = 1, or DAP_{mn} = 1 and CKP_{mn} = 0.3. When DAP_{mn} = 0 and CKP_{mn} = 0, or DAP_{mn} = 1 and CKP_{mn} = 1. The Slp hold time becomes “from SCKp↓” when DAP_{mn} = 0 and CKP_{mn} = 1, or DAP_{mn} = 1 and CKP_{mn} = 0.4. When DAP_{mn} = 0 and CKP_{mn} = 0, or DAP_{mn} = 1 and CKP_{mn} = 1. The delay time to SOp output becomes “from SCKp↑” when DAP_{mn} = 0 and CKP_{mn} = 1, or DAP_{mn} = 1 and CKP_{mn} = 0.

5. C is the load capacitance of the SCKp and SOp output lines.

Caution Select the normal input buffer for the Slp pin and the normal output mode for the SOp pin and SCKp pin by using port input mode register g (PIMg) and port output mode register g (POMg).**Remarks** 1. p: CSI number (p = 00, 01), m: Unit number (m = 0), n: Channel number (n = 0, 1),
g: PIM and POM numbers (g = 1)2. f_{MCK}: Serial array unit operation clock frequency
(Operation clock to be set by the serial clock select register m (SPSm) and the CKS_{mn} bit of serial mode register mn (SMR_{mn}). m: Unit number, n: Channel number (mn = 00, 01))

(3) During communication at same potential (CSI mode) (slave mode, SCKp... external clock input)
 (T_A = -40 to +105°C, 2.4 V ≤ EV_{DD} = V_{DD} ≤ 5.5 V, V_{SS} = EV_{SS} = 0 V)

Parameter	Symbol	Conditions		HS (high-speed main) Mode		Unit
				MIN.	MAX.	
SCKp cycle time ^{Note 5}	t _{KCY2}	4.0 V ≤ EV _{DD} ≤ 5.5 V	20 MHz < f _{MCK}	16/f _{MCK}		ns
			f _{MCK} ≤ 20 MHz	12/f _{MCK}		ns
		2.7 V ≤ EV _{DD} < 4.0 V	16 MHz < f _{MCK}	16/f _{MCK}		ns
			f _{MCK} ≤ 16 MHz	12/f _{MCK}		ns
		2.4 V ≤ EV _{DD} ≤ 5.5 V		12/f _{MCK} and 1000		ns
SCKp high-/low-level width	t _{KH2} , t _{KL2}	4.0 V ≤ EV _{DD} ≤ 5.5 V		t _{KCY2} /2 - 14		ns
		2.7 V ≤ EV _{DD} < 4.0 V		t _{KCY2} /2 - 16		ns
		2.4 V ≤ EV _{DD} < 2.7 V		t _{KCY2} /2 - 36		ns
Slp setup time (to SCKp↑) ^{Note 1}	t _{SIK2}	2.7 V ≤ EV _{DD} ≤ 5.5 V		1/f _{MCK} + 40		ns
		2.4 V ≤ EV _{DD} < 2.7 V		1/f _{MCK} + 60		ns
Slp hold time (from SCKp↑) ^{Note 2}	t _{KSI2}	2.4 V ≤ EV _{DD} ≤ 5.5 V		1/f _{MCK} + 62		ns
Delay time from SCKp↓ to SOp output ^{Note 3}	t _{KSO2}	C = 30 pF ^{Note 4}	4.0 V ≤ EV _{DD} ≤ 5.5 V		2/f _{MCK} + 66	ns
			2.7 V ≤ EV _{DD} < 4.0 V		2/f _{MCK} + 66	ns
			2.4 V ≤ EV _{DD} < 2.7 V		2/f _{MCK} + 113	Ns

- Notes**
1. When DAP_{mn} = 0 and CKP_{mn} = 0, or DAP_{mn} = 1 and CKP_{mn} = 1. The Slp setup time becomes “to SCKp↓” when DAP_{mn} = 0 and CKP_{mn} = 1, or DAP_{mn} = 1 and CKP_{mn} = 0.
 2. When DAP_{mn} = 0 and CKP_{mn} = 0, or DAP_{mn} = 1 and CKP_{mn} = 1. The Slp hold time becomes “from SCKp↓” when DAP_{mn} = 0 and CKP_{mn} = 1, or DAP_{mn} = 1 and CKP_{mn} = 0.
 3. When DAP_{mn} = 0 and CKP_{mn} = 0, or DAP_{mn} = 1 and CKP_{mn} = 1. The delay time to SOp output becomes “from SCKp↑” when DAP_{mn} = 0 and CKP_{mn} = 1, or DAP_{mn} = 1 and CKP_{mn} = 0.
 4. C is the load capacitance of the SOp output lines.
 5. Transfer rate in the SNOOZE mode : MAX. 1 Mbps

Caution Select the normal input buffer for the Slp pin and SCKp pin and the normal output mode for the SOp pin by using port input mode register g (PIMg) and port output mode register g (POMg).

- Remarks**
1. p: CSI number (p = 00, 01), m: Unit number (m = 0), n: Channel number (n = 0, 1), g: PIM number (g = 1)
 2. f_{MCK}: Serial array unit operation clock frequency
 (Operation clock to be set by the serial clock select register m (SPSm) and the CKSmn bit of serial mode register mn (SMRmn). m: Unit number, n: Channel number (mn = 00, 01))

CSI mode connection diagram (during communication at same potential)

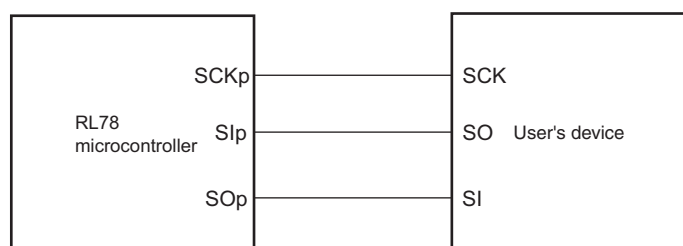

CSI mode serial transfer timing (during communication at same potential)
(When DAPmn = 0 and CKPmn = 0, or DAPmn = 1 and CKPmn = 1.)

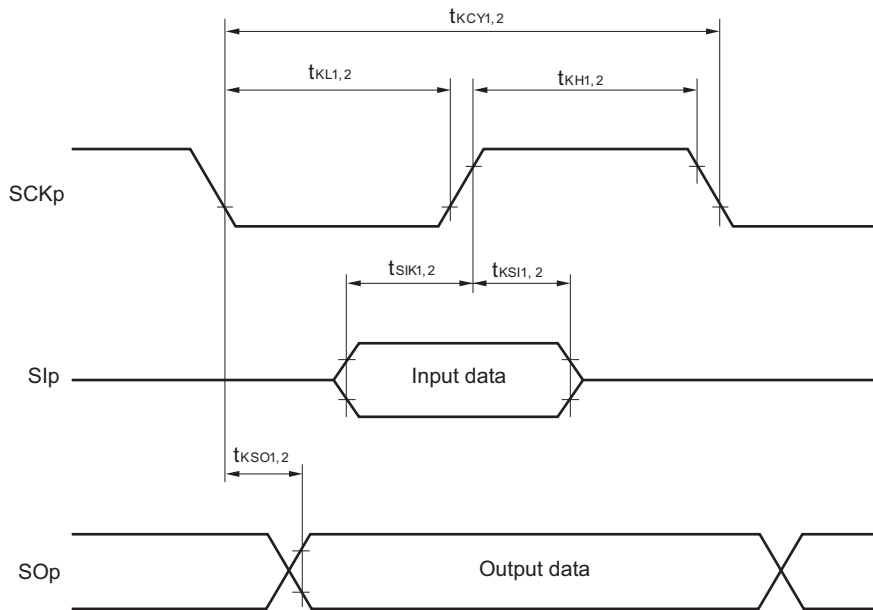

CSI mode serial transfer timing (during communication at same potential)
(When DAPmn = 0 and CKPmn = 1, or DAPmn = 1 and CKPmn = 0.)

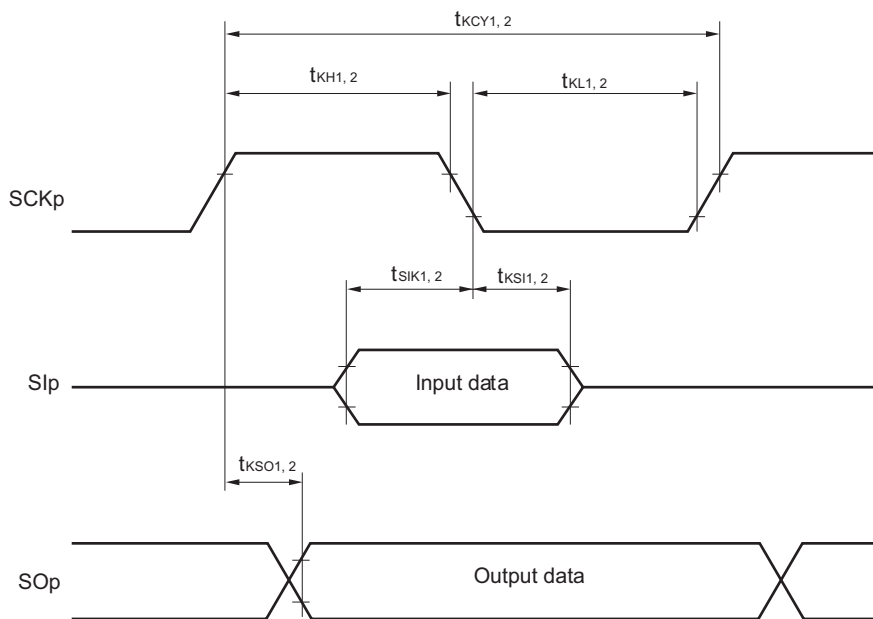

- Remarks**
1. p: CSI number (p = 00, 01)
 2. m: Unit number, n: Channel number (mn = 00, 01)

(4) Communication at different potential (1.8 V, 2.5 V, 3 V) (UART mode) (1/2)**(T_A = -40 to +105°C, 2.4 V ≤ EV_{DD} = V_{DD} ≤ 5.5 V, V_{SS} = EV_{SS} = 0 V)**

Parameter	Symbol	Conditions	HS (high-speed main) Mode		Unit	
			MIN.	MAX.		
Transfer rate		Reception	4.0 V ≤ EV _{DD} ≤ 5.5 V, 2.7 V ≤ V _b ≤ 4.0 V		f _{MCK} /12 ^{Note 1}	bps
				Theoretical value of the maximum transfer rate f _{MCK} = f _{CLK} ^{Note 2}		2.0
			2.7 V ≤ EV _{DD} < 4.0 V, 2.3 V ≤ V _b ≤ 2.7 V		f _{MCK} /12 ^{Note 1}	bps
				Theoretical value of the maximum transfer rate f _{MCK} = f _{CLK} ^{Note 2}		2.0
			2.4 V ≤ EV _{DD} < 3.3 V, 1.6 V ≤ V _b ≤ 2.0 V		f _{MCK} /12 ^{Note 1}	bps
				Theoretical value of the maximum transfer rate f _{MCK} = f _{CLK} ^{Note 2}		2.0

Notes 1. Transfer rate in the SNOOZE mode is 4800 bps only.**2.** The maximum operating frequencies of the CPU/peripheral hardware clock (f_{CLK}) are:HS (high-speed main) mode: 24 MHz (2.7 V ≤ V_{DD} ≤ 5.5 V)16 MHz (2.4 V ≤ V_{DD} ≤ 5.5 V)

Caution Select the TTL input buffer for the RxDq pin and the N-ch open drain output (V_{DD} tolerance (32- to 52-pin products)/EV_{DD} tolerance (64-pin products)) mode for the TxDq pin by using port input mode register g (PIMg) and port output mode register g (POMg). For V_{IH} and V_{IL}, see the DC characteristics with TTL input buffer selected.

Remarks 1. V_b[V]: Communication line voltage**2.** q: UART number (q = 0), g: PIM and POM number (g = 1)**3.** f_{MCK}: Serial array unit operation clock frequency

(Operation clock to be set by the serial clock select register m (SPSm) and the CKSmn bit of serial mode register mn (SMRmn). m: Unit number, n: Channel number (mn = 00, 01))

(4) Communication at different potential (1.8 V, 2.5 V, 3 V) (UART mode)

(2/2)

(T_A = -40 to +105°C, 2.4 V ≤ EV_{DD} = V_{DD} ≤ 5.5 V, V_{SS} = EV_{SS} = 0 V)

Parameter	Symbol	Conditions	HS (high-speed main) Mode		Unit	
			MIN.	MAX.		
Transfer rate		Transmission	4.0 V ≤ EV _{DD} ≤ 5.5 V, 2.7 V ≤ V _b ≤ 4.0 V		Note 1	bps
			Theoretical value of the maximum transfer rate C _b = 50 pF, R _b = 1.4 kΩ, V _b = 2.7 V		2.0 ^{Note 2}	Mbps
		2.7 V ≤ EV _{DD} < 4.0 V, 2.3 V ≤ V _b ≤ 2.7 V		Note 3	bps	
			Theoretical value of the maximum transfer rate C _b = 50 pF, R _b = 2.7 kΩ, V _b = 2.3 V		1.2 ^{Note 4}	Mbps
		2.4 V ≤ EV _{DD} < 3.3 V, 1.6 V ≤ V _b ≤ 2.0 V		Note 5	bps	
			Theoretical value of the maximum transfer rate C _b = 50 pF, R _b = 5.5 kΩ, V _b = 1.6 V		0.43 ^{Note 6}	Mbps

Notes 1. The smaller maximum transfer rate derived by using f_{MCK}/6 or the following expression is the valid maximum transfer rate.

Expression for calculating the transfer rate when 4.0 V ≤ EV_{DD} ≤ 5.5 V and 2.7 V ≤ V_b ≤ 4.0 V

$$\text{Maximum transfer rate} = \frac{1}{\{-C_b \times R_b \times \ln(1 - \frac{2.2}{V_b})\} \times 3} \text{ [bps]}$$

$$\text{Baud rate error (theoretical value)} = \frac{\frac{1}{\text{Transfer rate} \times 2} - \{-C_b \times R_b \times \ln(1 - \frac{2.2}{V_b})\}}{(\frac{1}{\text{Transfer rate}}) \times \text{Number of transferred bits}} \times 100 \text{ [%]}$$

* This value is the theoretical value of the relative difference between the transmission and reception sides.

2. This value as an example is calculated when the conditions described in the “Conditions” column are met. Refer to Note 1 above to calculate the maximum transfer rate under conditions of the customer.

3. The smaller maximum transfer rate derived by using f_{MCK}/6 or the following expression is the valid maximum transfer rate.

Expression for calculating the transfer rate when 2.7 V ≤ EV_{DD} < 4.0 V and 2.3 V ≤ V_b ≤ 2.7 V

$$\text{Maximum transfer rate} = \frac{1}{\{-C_b \times R_b \times \ln(1 - \frac{2.0}{V_b})\} \times 3} \text{ [bps]}$$

$$\text{Baud rate error (theoretical value)} = \frac{\frac{1}{\text{Transfer rate} \times 2} - \{-C_b \times R_b \times \ln(1 - \frac{2.0}{V_b})\}}{(\frac{1}{\text{Transfer rate}}) \times \text{Number of transferred bits}} \times 100 \text{ [%]}$$

* This value is the theoretical value of the relative difference between the transmission and reception sides.

4. This value as an example is calculated when the conditions described in the “Conditions” column are met. Refer to Note 3 above to calculate the maximum transfer rate under conditions of the customer.

5. The smaller maximum transfer rate derived by using $f_{MCK}/6$ or the following expression is the valid maximum transfer rate.

Expression for calculating the transfer rate when $1.8\text{ V} \leq EV_{DD} < 3.3\text{ V}$ and $1.6\text{ V} \leq V_b \leq 2.0\text{ V}$

$$\text{Maximum transfer rate} = \frac{1}{\{-C_b \times R_b \times \ln(1 - \frac{1.5}{V_b})\} \times 3} \text{ [bps]}$$

$$\text{Baud rate error (theoretical value)} = \frac{\frac{1}{\text{Transfer rate} \times 2} - \{-C_b \times R_b \times \ln(1 - \frac{1.5}{V_b})\}}{(\frac{1}{\text{Transfer rate}}) \times \text{Number of transferred bits}} \times 100 \text{ [%]}$$

* This value is the theoretical value of the relative difference between the transmission and reception sides.

6. This value as an example is calculated when the conditions described in the "Conditions" column are met. Refer to Note 5 above to calculate the maximum transfer rate under conditions of the customer.

Caution Select the TTL input buffer for the RxDq pin and the N-ch open drain output (V_{DD} tolerance (32- to 52-pin products)/EV_{DD} tolerance (64-pin products)) mode for the TxDq pin by using port input mode register g (PIMg) and port output mode register g (POMg). For V_{IH} and V_{IL}, see the DC characteristics with TTL input buffer selected.

UART mode connection diagram (during communication at different potential)

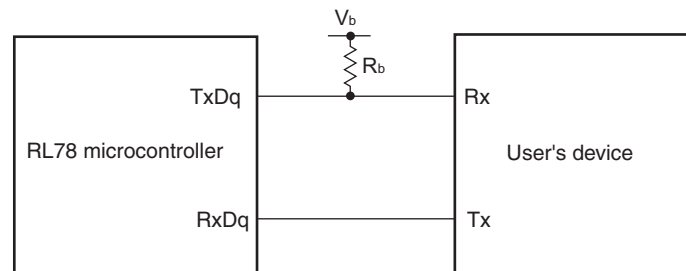

UART mode bit width (during communication at different potential) (reference)

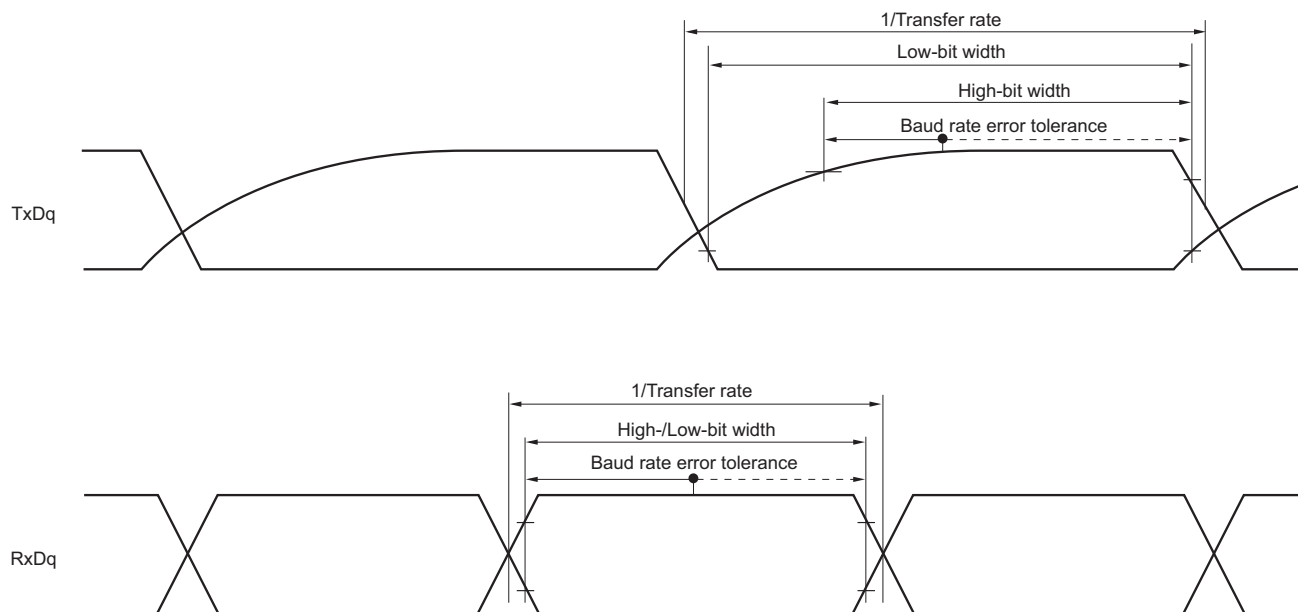

- Remarks 1.** $R_b[\Omega]$: Communication line (TxDq) pull-up resistance,
 $C_b[F]$: Communication line (TxDq) load capacitance, $V_b[V]$: Communication line voltage
- 2.** q: UART number (q = 0, 1), g: PIM and POM number (g = 1)
- 3.** f_{MCK} : Serial array unit operation clock frequency
 (Operation clock to be set by the serial clock select register m (SPSm) and the CKSmn bit of serial mode register mn (SMRmn). m: Unit number, n: Channel number (mn = 00, 01))

(5) Communication at different potential (1.8 V, 2.5 V, 3 V) (CSI mode) (master mode, SCKp... internal clock output)**(1/2)****(T_A = -40 to +105°C, 2.4 V ≤ EV_{DD} = V_{DD} ≤ 5.5 V, V_{SS} = EV_{SS} = 0 V)**

Parameter	Symbol	Conditions	HS (high-speed main) Mode		Unit
			MIN.	MAX.	
SCKp cycle time	t _{KCY1}	t _{KCY1} ≥ 4/f _{CLK} 4.0 V ≤ EV _{DD} ≤ 5.5 V, 2.7 V ≤ V _b ≤ 4.0 V, C _b = 30 pF, R _b = 1.4 kΩ	600		ns
		2.7 V ≤ EV _{DD} < 4.0 V, 2.3 V ≤ V _b ≤ 2.7 V, C _b = 30 pF, R _b = 2.7 kΩ	600		ns
		2.4 V ≤ EV _{DD} < 3.3 V, 1.6 V ≤ V _b ≤ 2.0 V, C _b = 30 pF, R _b = 5.5 kΩ	2300		ns
SCKp high-level width	t _{KH1}	4.0 V ≤ EV _{DD} ≤ 5.5 V, 2.7 V ≤ V _b ≤ 4.0 V, C _b = 30 pF, R _b = 1.4 kΩ	t _{KCY1} /2 - 150		ns
		2.7 V ≤ EV _{DD} < 4.0 V, 2.3 V ≤ V _b ≤ 2.7 V, C _b = 30 pF, R _b = 2.7 kΩ	t _{KCY1} /2 - 340		ns
		2.4 V ≤ EV _{DD} < 3.3 V, 1.6 V ≤ V _b ≤ 2.0 V, C _b = 30 pF, R _b = 5.5 kΩ	t _{KCY1} /2 - 916		ns
SCKp low-level width	t _{KL1}	4.0 V ≤ EV _{DD} ≤ 5.5 V, 2.7 V ≤ V _b ≤ 4.0 V, C _b = 30 pF, R _b = 1.4 kΩ	t _{KCY1} /2 - 24		ns
		2.7 V ≤ EV _{DD} < 4.0 V, 2.3 V ≤ V _b ≤ 2.7 V, C _b = 30 pF, R _b = 2.7 kΩ	t _{KCY1} /2 - 36		ns
		2.4 V ≤ EV _{DD} < 3.3 V, 1.6 V ≤ V _b ≤ 2.0 V, C _b = 30 pF, R _b = 5.5 kΩ	t _{KCY1} /2 - 100		ns

Caution Select the TTL input buffer for the SIp pin and the N-ch open drain output (V_{DD} tolerance (32- to 52-pin products)/EV_{DD} tolerance (64-pin products)) mode for the SOp pin and SCKp pin by using port input mode register g (PIMg) and port output mode register g (POMg). For V_{IH} and V_{IL}, see the DC characteristics with TTL input buffer selected.

(5) Communication at different potential (1.8 V, 2.5 V, 3 V) (CSI mode) (master mode, SCKp... internal clock output)**(2/2)****(T_A = -40 to +105°C, 2.4 V ≤ EV_{DD} = V_{DD} ≤ 5.5 V, V_{SS} = EV_{SS} = 0 V)**

Parameter	Symbol	Conditions	HS (high-speed main) Mode		Unit
			MIN.	MAX.	
Slp setup time (to SCKp↑) ^{Note 1}	t _{SIK1}	4.0 V ≤ EV _{DD} ≤ 5.5 V, 2.7 V ≤ V _b ≤ 4.0 V, C _b = 30 pF, R _b = 1.4 kΩ	162		ns
		2.7 V ≤ EV _{DD} < 4.0 V, 2.3 V ≤ V _b ≤ 2.7 V, C _b = 30 pF, R _b = 2.7 kΩ	354		ns
		2.4 V ≤ EV _{DD} < 3.3 V, 1.6 V ≤ V _b ≤ 2.0 V, C _b = 30 pF, R _b = 5.5 kΩ	958		ns
Slp hold time (from SCKp↑) ^{Note 1}	t _{SIH1}	4.0 V ≤ EV _{DD} ≤ 5.5 V, 2.7 V ≤ V _b ≤ 4.0 V, C _b = 30 pF, R _b = 1.4 kΩ	38		ns
		2.7 V ≤ EV _{DD} < 4.0 V, 2.3 V ≤ V _b ≤ 2.7 V, C _b = 30 pF, R _b = 2.7 kΩ	38		ns
		2.4 V ≤ EV _{DD} < 3.3 V, 1.6 V ≤ V _b ≤ 2.0 V, C _b = 30 pF, R _b = 5.5 kΩ	38		ns
Delay time from SCKp↓ to SO _p output ^{Note 1}	t _{KSO1}	4.0 V ≤ EV _{DD} ≤ 5.5 V, 2.7 V ≤ V _b ≤ 4.0 V, C _b = 30 pF, R _b = 1.4 kΩ		200	ns
		2.7 V ≤ EV _{DD} < 4.0 V, 2.3 V ≤ V _b ≤ 2.7 V, C _b = 30 pF, R _b = 2.7 kΩ		390	ns
		2.4 V ≤ EV _{DD} < 3.3 V, 1.6 V ≤ V _b ≤ 2.0 V, C _b = 30 pF, R _b = 2.7 kΩ		966	ns
Slp setup time (to SCKp↓) ^{Note}	t _{SIK1}	4.0 V ≤ EV _{DD} ≤ 5.5 V, 2.7 V ≤ V _b ≤ 4.0 V, C _b = 30 pF, R _b = 1.4 kΩ	88		ns
		2.7 V ≤ EV _{DD} < 4.0 V, 2.3 V ≤ V _b ≤ 2.7 V, C _b = 30 pF, R _b = 2.7 kΩ	88		ns
		2.4 V ≤ EV _{DD} < 3.3 V, 1.6 V ≤ V _b ≤ 2.0 V, C _b = 30 pF, R _b = 5.5 kΩ	220		ns
Slp hold time (from SCKp↓) ^{Note 2}	t _{SIH1}	4.0 V ≤ EV _{DD} ≤ 5.5 V, 2.7 V ≤ V _b ≤ 4.0 V, C _b = 30 pF, R _b = 1.4 kΩ	38		ns
		2.7 V ≤ EV _{DD} < 4.0 V, 2.3 V ≤ V _b ≤ 2.7 V, C _b = 30 pF, R _b = 2.7 kΩ	38		ns
		2.4 V ≤ EV _{DD} < 3.3 V, 1.6 V ≤ V _b ≤ 2.0 V, C _b = 30 pF, R _b = 5.5 kΩ	38		ns
Delay time from SCKp↑ to SO _p output ^{Note 2}	t _{KSO1}	4.0 V ≤ EV _{DD} ≤ 5.5 V, 2.7 V ≤ V _b ≤ 4.0 V, C _b = 30 pF, R _b = 1.4 kΩ		50	ns
		2.7 V ≤ EV _{DD} < 4.0 V, 2.3 V ≤ V _b ≤ 2.7 V, C _b = 30 pF, R _b = 2.7 kΩ		50	ns
		2.4 V ≤ EV _{DD} < 3.3 V, 1.6 V ≤ V _b ≤ 2.0 V, C _b = 30 pF, R _b = 5.5 kΩ		50	ns

(Notes, Caution and Remarks are listed on the page after the next page.)

- Notes**
1. When $\text{DAPmn} = 0$ and $\text{CKPmn} = 0$, or $\text{DAPmn} = 1$ and $\text{CKPmn} = 1$.
 2. When $\text{DAPmn} = 0$ and $\text{CKPmn} = 1$, or $\text{DAPmn} = 1$ and $\text{CKPmn} = 0$.

Caution Select the TTL input buffer for the Slp pin and the N-ch open drain output (V_{DD} tolerance (32- to 52-pin products)/ E_{VDD} tolerance (64-pin products)) mode for the SOp pin and SCKp pin by using port input mode register g (PIMg) and port output mode register g (POMg). For V_{IH} and V_{IL} , see the DC characteristics with TTL input buffer selected.

CSI mode connection diagram (during communication at different potential)

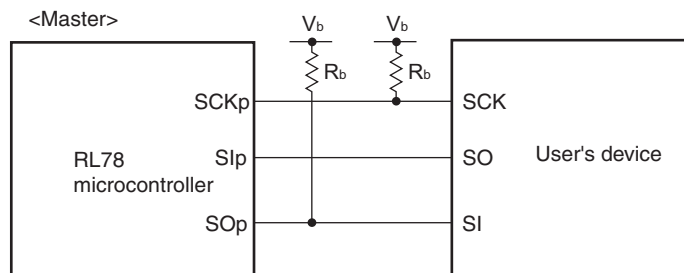

- Remarks**
1. $R_b[\Omega]$: Communication line (SCKp , SOp) pull-up resistance,
 $C_b[\text{F}]$: Communication line (SCKp , SOp) load capacitance, $V_b[\text{V}]$: Communication line voltage
 2. p : CSI number ($p = 00, 01$), m : Unit number ($m = 0$), n : Channel number ($n = 0, 1$),
 g : PIM and POM number ($g = 1$)
 3. f_{MCK} : Serial array unit operation clock frequency
 (Operation clock to be set by the serial clock select register m (SPSm) and the CKSmn bit of serial mode register mn (SMRmn). m : Unit number, n : Channel number ($mn = 00$))

CSI mode serial transfer timing (master mode) (during communication at different potential)
(When DAPmn = 0 and CKPmn = 0, or DAPmn = 1 and CKPmn = 1.)

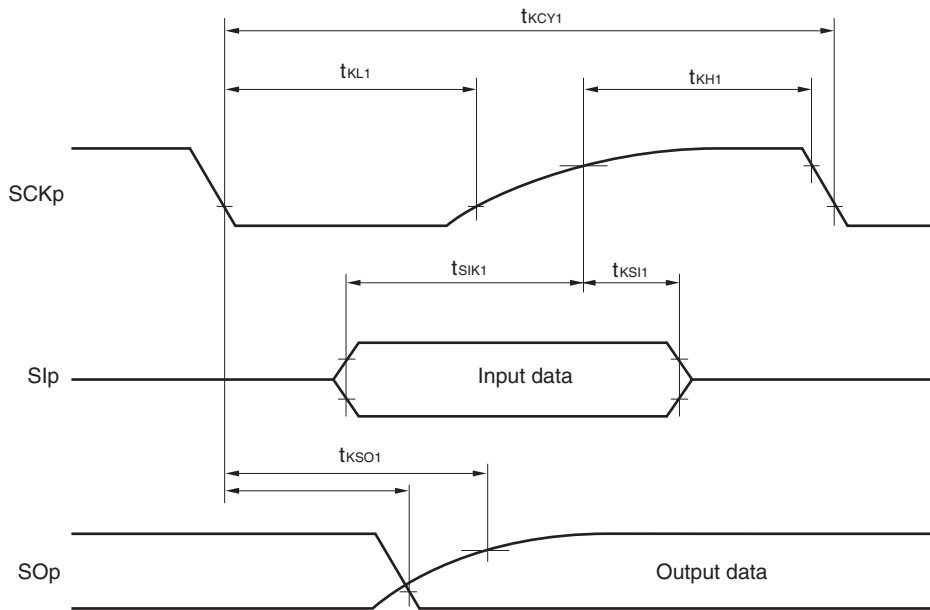

CSI mode serial transfer timing (master mode) (during communication at different potential)
(When DAPmn = 0 and CKPmn = 1, or DAPmn = 1 and CKPmn = 0.)

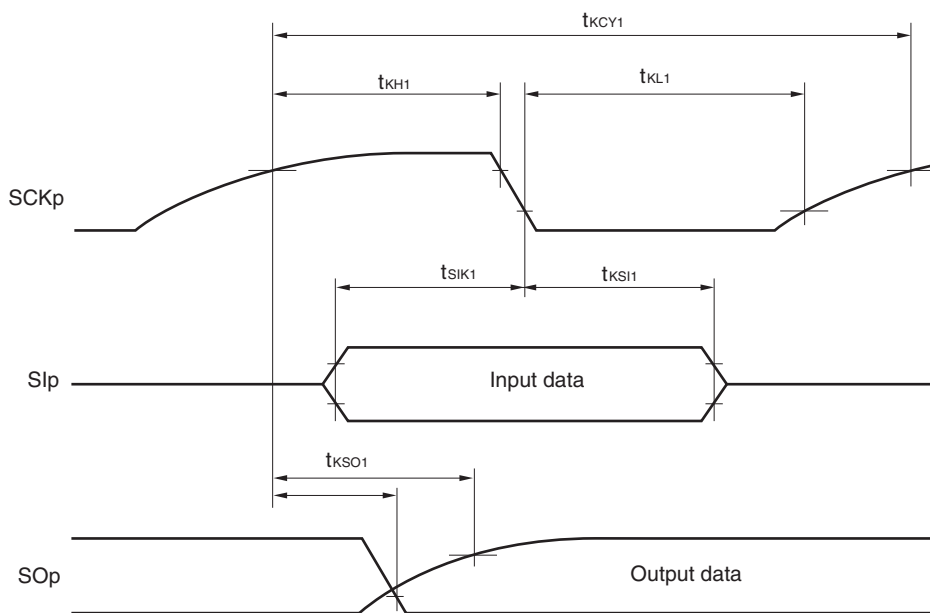

Remark p: CSI number (p = 00, 01), m: Unit number (m = 0), n: Channel number (n = 0, 1),
g: PIM and POM number (g = 1)

(6) Communication at different potential (1.8 V, 2.5 V, 3 V) (CSI mode) (slave mode, SCKp... external clock input)
(T_A = -40 to +105°C, 2.4 V ≤ EV_{DD} = V_{DD} ≤ 5.5 V, V_{SS} = EV_{SS} = 0 V)

Parameter	Symbol	Conditions	HS (high-speed main) Mode		Unit			
			MIN.	MAX.				
SCKp cycle time ^{Note 1}	t _{KCY2}	4.0 V ≤ EV _{DD} ≤ 5.5 V, 2.7 V ≤ V _b ≤ 4.0 V	20 MHz < f _{MCK} ≤ 24 MHz	24/f _{MCK}	ns			
			8 MHz < f _{MCK} ≤ 20 MHz	20/f _{MCK}	ns			
			4 MHz < f _{MCK} ≤ 8 MHz	16/f _{MCK}	ns			
			f _{MCK} ≤ 4 MHz	12/f _{MCK}	ns			
		2.7 V ≤ EV _{DD} < 4.0 V, 2.3 V ≤ V _b ≤ 2.7 V	20 MHz < f _{MCK} ≤ 24 MHz	32/f _{MCK}	ns			
			16 MHz < f _{MCK} ≤ 20 MHz	28/f _{MCK}	ns			
			8 MHz < f _{MCK} ≤ 16 MHz	24/f _{MCK}	ns			
			4 MHz < f _{MCK} ≤ 8 MHz	16/f _{MCK}	ns			
		2.4 V ≤ EV _{DD} < 3.3 V, 1.6 V ≤ V _b ≤ 2.0 V	20 MHz < f _{MCK} ≤ 24 MHz	72/f _{MCK}	ns			
			16 MHz < f _{MCK} ≤ 20 MHz	64/f _{MCK}	ns			
			8 MHz < f _{MCK} ≤ 16 MHz	52/f _{MCK}	ns			
			4 MHz < f _{MCK} ≤ 8 MHz	32/f _{MCK}	ns			
			f _{MCK} ≤ 4 MHz	20/f _{MCK}	ns			
			SCKp high-/low-level width		t _{KH2} , t _{KL2}	4.0 V ≤ EV _{DD} ≤ 5.5 V, 2.7 V ≤ V _b ≤ 4.0 V	t _{KCY2} /2 – 24	ns
						2.7 V ≤ EV _{DD} < 4.0 V, 2.3 V ≤ V _b ≤ 2.7 V	t _{KCY2} /2 – 36	ns
						2.4 V ≤ EV _{DD} < 3.3 V, 1.6 V ≤ V _b ≤ 2.0 V	t _{KCY2} /2 – 100	ns
Slp setup time (to SCKp↑) ^{Note 2}	t _{SIK2}	4.0 V ≤ EV _{DD} ≤ 5.5 V, 2.7 V ≤ V _b ≤ 4.0 V	1/f _{MCK} + 40	ns				
		2.7 V ≤ EV _{DD} < 4.0 V, 2.3 V ≤ V _b ≤ 2.7 V	1/f _{MCK} + 40	ns				
		2.4 V ≤ EV _{DD} < 3.3 V, 1.6 V ≤ V _b ≤ 2.0 V	1/f _{MCK} + 60	ns				
Slp hold time (from SCKp↑) ^{Note 3}	t _{KSI2}	4.0 V ≤ EV _{DD} ≤ 5.5 V, 2.7 V ≤ V _b ≤ 4.0 V	1/f _{MCK} + 62	ns				
		2.7 V ≤ EV _{DD} < 4.0 V, 2.3 V ≤ V _b ≤ 2.7 V	1/f _{MCK} + 62	ns				
		2.4 V ≤ EV _{DD} < 3.3 V, 1.6 V ≤ V _b ≤ 2.0 V	1/f _{MCK} + 62	ns				
Delay time from SCKp↓ to SOp output ^{Note 4}	t _{KSO2}	4.0 V ≤ EV _{DD} ≤ 5.5 V, 2.7 V ≤ V _b ≤ 4.0 V, C _b = 30 pF, R _b = 1.4 kΩ		2/f _{MCK} + 240	ns			
		2.7 V ≤ EV _{DD} < 4.0 V, 2.3 V ≤ V _b ≤ 2.7 V, C _b = 30 pF, R _b = 2.7 kΩ		2/f _{MCK} + 428	ns			
		2.4 V ≤ EV _{DD} < 3.3 V, 1.6 V ≤ V _b ≤ 2.0 V C _b = 30 pF, R _b = 5.5 kΩ		2/f _{MCK} + 1146	ns			

(Notes, Caution and Remarks are listed on the page after the next page.)

- Notes**
1. Transfer rate in the SNOOZE mode : MAX. 1 Mbps
 2. When $\text{DAPmn} = 0$ and $\text{CKPmn} = 0$, or $\text{DAPmn} = 1$ and $\text{CKPmn} = 1$. The Slp setup time becomes “to $\text{SCKp}\downarrow$ ” when $\text{DAPmn} = 0$ and $\text{CKPmn} = 1$, or $\text{DAPmn} = 1$ and $\text{CKPmn} = 0$.
 3. When $\text{DAPmn} = 0$ and $\text{CKPmn} = 0$, or $\text{DAPmn} = 1$ and $\text{CKPmn} = 1$. The Slp hold time becomes “from $\text{SCKp}\downarrow$ ” when $\text{DAPmn} = 0$ and $\text{CKPmn} = 1$, or $\text{DAPmn} = 1$ and $\text{CKPmn} = 0$.
 4. When $\text{DAPmn} = 0$ and $\text{CKPmn} = 0$, or $\text{DAPmn} = 1$ and $\text{CKPmn} = 1$. The delay time to SOp output becomes “from $\text{SCKp}\uparrow$ ” when $\text{DAPmn} = 0$ and $\text{CKPmn} = 1$, or $\text{DAPmn} = 1$ and $\text{CKPmn} = 0$.

Caution Select the TTL input buffer for the Slp pin and SCKp pin and the N-ch open drain output (V_{DD} tolerance (32- to 52-pin products)/ EV_{DD} tolerance (64-pin products)) mode for the SOp pin by using port input mode register g (PIMg) and port output mode register g (POMg). For V_{IH} and V_{IL} , see the DC characteristics with TTL input buffer selected.

CSI mode connection diagram (during communication at different potential)

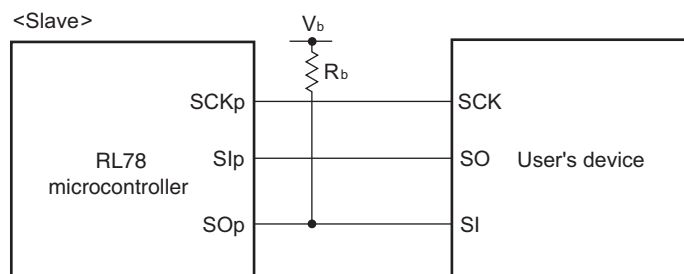

- Remarks**
1. $R_b[\Omega]$: Communication line (SOp) pull-up resistance,
 $C_b[\text{F}]$: Communication line (SOp) load capacitance, $V_b[\text{V}]$: Communication line voltage
 2. p: CSI number ($p = 00, 01$), m: Unit number ($m = 0$), n: Channel number ($n = 0, 1$),
g: PIM and POM number ($g = 1$)
 3. f_{MCK} : Serial array unit operation clock frequency
(Operation clock to be set by the serial clock select register m (SPSm) and the CKSmn bit of serial mode register mn (SMRmn). m: Unit number, n: Channel number ($mn = 00, 01$))

CSI mode serial transfer timing (slave mode) (during communication at different potential)
(When DAPmn = 0 and CKPmn = 0, or DAPmn = 1 and CKPmn = 1.)

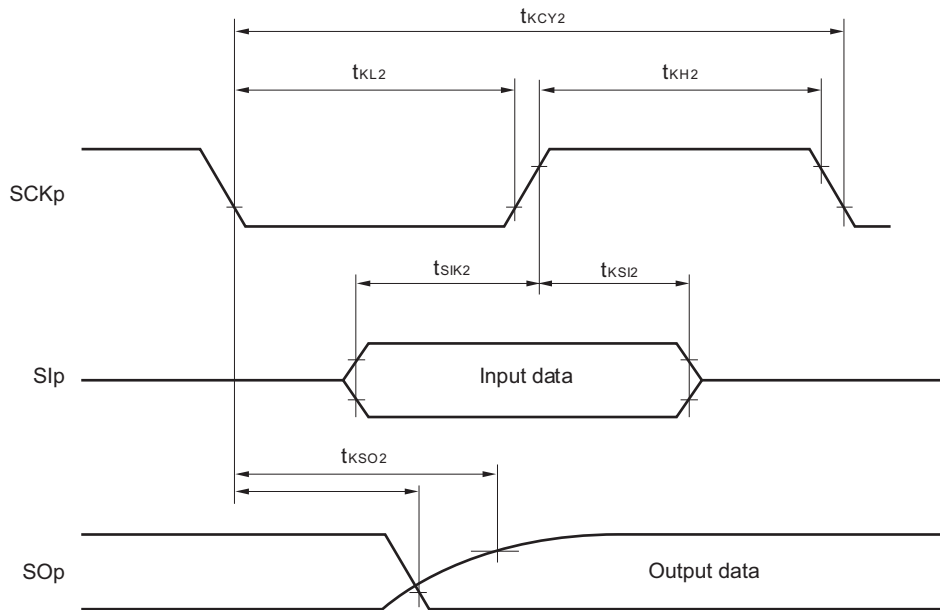

CSI mode serial transfer timing (slave mode) (during communication at different potential)
(When DAPmn = 0 and CKPmn = 1, or DAPmn = 1 and CKPmn = 0.)

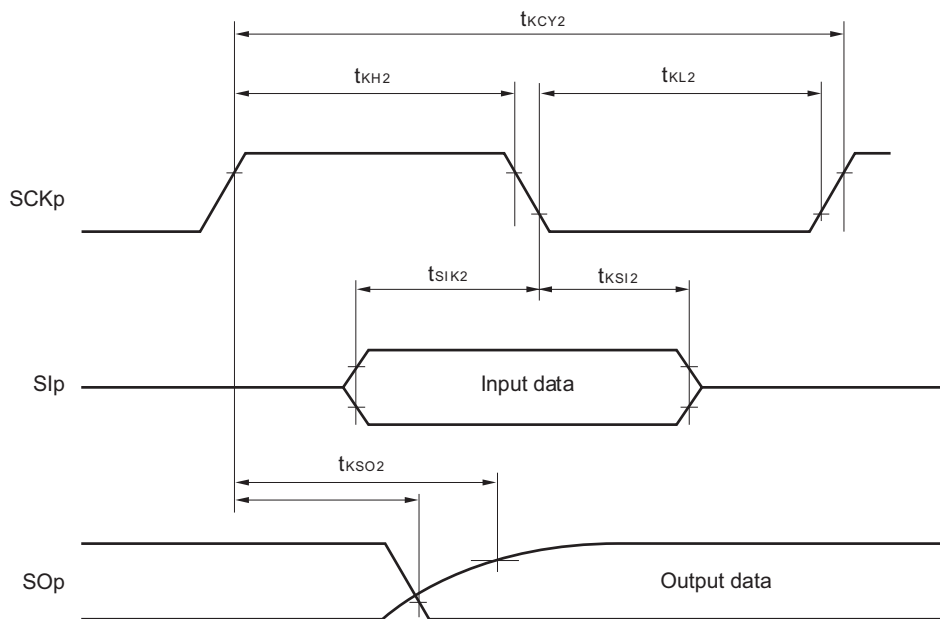

Remark p: CSI number (p = 00, 01), m: Unit number (m = 0),
 n: Channel number (n = 0, 1), g: PIM and POM number (g = 1)

3.5.2 Serial interface IICA

(1) I²C standard mode(T_A = -40 to +105°C, 2.4 V ≤ E_{VDD} = V_{DD} ≤ 5.5 V, V_{SS} = E_{VSS} = 0 V)

Parameter	Symbol	Conditions	HS (high-speed main) Mode		Unit	
			MIN.	MAX.		
SCLA0 clock frequency	f _{SCL}	Standard mode:	2.7 V ≤ E _{VDD} ≤ 5.5 V	0	100	kHz
		f _{CLK} ≥ 1 MHz	2.4 V ≤ E _{VDD} ≤ 5.5 V	0	100	kHz
Setup time of restart condition	t _{SU:STA}	2.7 V ≤ E _{VDD} ≤ 5.5 V	4.7		μs	
		2.4 V ≤ E _{VDD} ≤ 5.5 V	4.7		μs	
Hold time ^{Note 1}	t _{HD:STA}	2.7 V ≤ E _{VDD} ≤ 5.5 V	4.0		μs	
		2.4 V ≤ E _{VDD} ≤ 5.5 V	4.0		μs	
Hold time when SCLA0 = "L"	t _{LOW}	2.7 V ≤ E _{VDD} ≤ 5.5 V	4.7		μs	
		2.4 V ≤ E _{VDD} ≤ 5.5 V	4.7		μs	
Hold time when SCLA0 = "H"	t _{HIGH}	2.7 V ≤ E _{VDD} ≤ 5.5 V	4.0		μs	
		2.4 V ≤ E _{VDD} ≤ 5.5 V	4.0		μs	
Data setup time (reception)	t _{SU:DAT}	2.7 V ≤ E _{VDD} ≤ 5.5 V	250		ns	
		2.4 V ≤ E _{VDD} ≤ 5.5 V	250		ns	
Data hold time (transmission) ^{Note 2}	t _{HD:DAT}	2.7 V ≤ E _{VDD} ≤ 5.5 V	0	3.45	μs	
		2.4 V ≤ E _{VDD} ≤ 5.5 V	0	3.45	μs	
Setup time of stop condition	t _{SU:STO}	2.7 V ≤ E _{VDD} ≤ 5.5 V	4.0		μs	
		2.4 V ≤ E _{VDD} ≤ 5.5 V	4.0		μs	
Bus-free time	t _{BUF}	2.7 V ≤ E _{VDD} ≤ 5.5 V	4.7		μs	
		2.4 V ≤ E _{VDD} ≤ 5.5 V	4.7		μs	

- Notes**
1. The first clock pulse is generated after this period when the start/restart condition is detected.
 2. The maximum value (MAX.) of t_{HD:DAT} is during normal transfer and a wait state is inserted in the ACK (acknowledge) timing.

Remark The maximum value of C_b (communication line capacitance) and the value of R_b (communication line pull-up resistor) at that time in each mode are as follows.

Standard mode: C_b = 400 pF, R_b = 2.7 kΩ

(2) I²C fast mode**(T_A = -40 to +105°C, 2.4 V ≤ EV_{DD} = V_{DD} ≤ 5.5 V, V_{SS} = EV_{SS} = 0 V)**

Parameter	Symbol	Conditions	HS (high-speed main) Mode		Unit	
			MIN.	MAX.		
SCLA0 clock frequency	f _{SCL}	Fast mode: f _{CLK} ≥ 3.5 MHz	2.7 V ≤ EV _{DD} ≤ 5.5 V	0	400	kHz
			2.4 V ≤ EV _{DD} ≤ 5.5 V	0	400	
Setup time of restart condition	t _{SU:STA}	2.7 V ≤ EV _{DD} ≤ 5.5 V		0.6		μs
		2.4 V ≤ EV _{DD} ≤ 5.5 V		0.6		
Hold time ^{Note 1}	t _{HD:STA}	2.7 V ≤ EV _{DD} ≤ 5.5 V		0.6		μs
		2.4 V ≤ EV _{DD} ≤ 5.5 V		0.6		
Hold time when SCLA0 = "L"	t _{LOW}	2.7 V ≤ EV _{DD} ≤ 5.5 V		1.3		μs
		2.4 V ≤ EV _{DD} ≤ 5.5 V		1.3		
Hold time when SCLA0 = "H"	t _{HIGH}	2.7 V ≤ EV _{DD} ≤ 5.5 V		0.6		μs
		2.4 V ≤ EV _{DD} ≤ 5.5 V		0.6		
Data setup time (reception)	t _{SU:DAT}	2.7 V ≤ EV _{DD} ≤ 5.5 V		100		ns
		2.4 V ≤ EV _{DD} ≤ 5.5 V		100		
Data hold time (transmission) ^{Note 2}	t _{HD:DAT}	2.7 V ≤ EV _{DD} ≤ 5.5 V		0	0.9	μs
		2.4 V ≤ EV _{DD} ≤ 5.5 V		0	0.9	
Setup time of stop condition	t _{SU:STO}	2.7 V ≤ EV _{DD} ≤ 5.5 V		0.6		μs
		2.4 V ≤ EV _{DD} ≤ 5.5 V		0.6		
Bus-free time	t _{BUF}	2.7 V ≤ EV _{DD} ≤ 5.5 V		1.3		μs
		2.4 V ≤ EV _{DD} ≤ 5.5 V		1.3		

- Notes**
1. The first clock pulse is generated after this period when the start/restart condition is detected.
 2. The maximum value (MAX.) of t_{HD:DAT} is during normal transfer and a wait state is inserted in the ACK (acknowledge) timing.

Remark The maximum value of C_b (communication line capacitance) and the value of R_b (communication line pull-up resistor) at that time in each mode are as follows.

Fast mode: C_b = 320 pF, R_b = 1.1 kΩ

3.6 Analog Characteristics

3.6.1 A/D converter characteristics

Classification of A/D converter characteristics

Input channel	Reference Voltage		
	Reference voltage (+) = AV _{REFP} Reference voltage (-) = AV _{REFM}	Reference voltage (+) = V _{DD} Reference voltage (-) = V _{SS}	Reference voltage (+) = V _{BGR} Reference voltage (-) = AV _{REFM}
ANI0, ANI1	–	Refer to 3.6.1 (3) .	Refer to 3.6.1 (4) .
ANI16 to ANI23	Refer to 3.6.1 (2) .		
Internal reference voltage Temperature sensor output voltage	Refer to 3.6.1 (1) .		–

(1) When reference voltage (+) = AV_{REFP}/ANI0 (ADREFP1 = 0, ADREFP0 = 1), reference voltage (-) = AV_{REFM}/ANI1 (ADREFM = 1), target pin : internal reference voltage, and temperature sensor output voltage

(T_A = -40 to +105°C, 2.4 V ≤ EV_{DD} = V_{DD} ≤ 5.5 V, 2.4 V ≤ AV_{REFP} ≤ V_{DD} ≤ 5.5 V, V_{SS} = EV_{SS} = 0 V, Reference voltage (+) = AV_{REFP}, Reference voltage (-) = AV_{REFM} = 0 V)

Parameter	Symbol	Conditions	MIN.	TYP.	MAX.	Unit
Resolution	RES		8		10	bit
Overall error ^{Note 1}	AINL	10-bit resolution AV _{REFP} = V _{DD} ^{Note 3}	2.4 V ≤ AV _{REFP} ≤ 5.5 V	1.2	±3.5	LSB
Conversion time	t _{CONV}	10-bit resolution Target pin: Internal reference voltage, and temperature sensor output voltage (HS (high-speed main) mode)	3.6 V ≤ V _{DD} ≤ 5.5 V	2.375	39	μs
			2.7 V ≤ V _{DD} ≤ 5.5 V	3.5625	39	μs
			2.4 V ≤ V _{DD} ≤ 5.5 V	17	39	μs
Zero-scale error ^{Notes 1, 2}	E _{ZS}	10-bit resolution AV _{REFP} = V _{DD} ^{Note 3}	1.8 V ≤ AV _{REFP} ≤ 5.5 V		±0.25	%FSR
Full-scale error ^{Notes 1, 2}	E _{FS}	10-bit resolution AV _{REFP} = V _{DD} ^{Note 3}	1.8 V ≤ AV _{REFP} ≤ 5.5 V		±0.25	%FSR
Integral linearity error ^{Note 1}	ILE	10-bit resolution AV _{REFP} = V _{DD} ^{Note 3}	1.8 V ≤ AV _{REFP} ≤ 5.5 V		±2.5	LSB
Differential linearity error ^{Note 1}	DLE	10-bit resolution AV _{REFP} = V _{DD} ^{Note 3}	1.8 V ≤ AV _{REFP} ≤ 5.5 V		±1.5	LSB
Analog input voltage	V _{AIN}	Internal reference voltage (2.4 V ≤ V _{DD} ≤ 5.5 V, HS (high-speed main) mode)	V _{BGR} ^{Note 4}			V
		Temperature sensor output voltage (2.4 V ≤ V _{DD} ≤ 5.5 V, HS (high-speed main) mode)	V _{TMPS25} ^{Note 4}			V

Notes 1. Excludes quantization error (±1/2 LSB).

2. This value is indicated as a ratio (%FSR) to the full-scale value.

3. When AV_{REFP} < V_{DD}, the MAX. values are as follows.

Overall error: Add ±1.0 LSB to the MAX. value when AV_{REFP} = V_{DD}.

Zero-scale error/Full-scale error: Add ±0.05%FSR to the MAX. value when AV_{REFP} = V_{DD}.

Integral linearity error/ Differential linearity error: Add ±0.5 LSB to the MAX. value when AV_{REFP} = V_{DD}.

4. Refer to **3.6.2 Temperature sensor/internal reference voltage characteristics**.

(2) When reference voltage (+) = AV_{REFP}/ANI0 (ADREFP1 = 0, ADREFP0 = 1), reference voltage (-) = AV_{REFM}/ANI1 (ADREFM = 1), target pin : ANI16 to ANI23

(T_A = -40 to +105°C, 2.4 V ≤ EV_{DD} = V_{DD} ≤ 5.5 V, 2.4 V ≤ AV_{REFP} ≤ V_{DD} ≤ 5.5 V, V_{SS} = EV_{SS} = 0 V, Reference voltage (+) = AV_{REFP}, Reference voltage (-) = AV_{REFM} = 0 V)

Parameter	Symbol	Conditions	MIN.	TYP.	MAX.	Unit
Resolution	RES		8		10	bit
Overall error ^{Note 1}	AINL	10-bit resolution AV _{REFP} = EV _{DD} = V _{DD} ^{Note 3}	2.4 V ≤ AV _{REFP} ≤ 5.5 V	1.2	±5.0	LSB
Conversion time	t _{CONV}	10-bit resolution AV _{REFP} = EV _{DD} = V _{DD} ^{Note 3}	3.6 V ≤ V _{DD} ≤ 5.5 V	2.125	39	μs
			2.7 V ≤ V _{DD} ≤ 5.5 V	3.1875	39	μs
			2.4 V ≤ V _{DD} ≤ 5.5 V	17	39	μs
Zero-scale error ^{Notes 1, 2}	E _{ZS}	10-bit resolution AV _{REFP} = EV _{DD} = V _{DD} ^{Note 3}	2.4 V ≤ AV _{REFP} ≤ 5.5 V		±0.35	%FSR
Full-scale error ^{Notes 1, 2}	E _{FS}	10-bit resolution AV _{REFP} = EV _{DD} = V _{DD} ^{Note 3}	2.4 V ≤ AV _{REFP} ≤ 5.5 V		±0.35	%FSR
Integral linearity error ^{Note 1}	ILE	10-bit resolution AV _{REFP} = EV _{DD} = V _{DD} ^{Note 3}	2.4 V ≤ AV _{REFP} ≤ 5.5 V		±3.5	LSB
Differential linearity error ^{Note 1}	DLE	10-bit resolution AV _{REFP} = EV _{DD} = V _{DD} ^{Note 3}	2.4 V ≤ AV _{REFP} ≤ 5.5 V		±2.0	LSB
Analog input voltage	V _{AIN}	ANI16 to ANI23	0		AV _{REFP} and EV _{DD}	V

Notes 1. Excludes quantization error (±1/2 LSB).

2. This value is indicated as a ratio (%FSR) to the full-scale value.

3. When AV_{REFP} < EV_{DD} = V_{DD}, the MAX. values are as follows.

Overall error: Add ±4.0 LSB to the MAX. value when AV_{REFP} = V_{DD}.

Zero-scale error/Full-scale error: Add ±0.20%FSR to the MAX. value when AV_{REFP} = V_{DD}.

Integral linearity error/ Differential linearity error: Add ±2.0 LSB to the MAX. value when AV_{REFP} = V_{DD}.

(3) When reference voltage (+) = V_{DD} (ADREFP1 = 0, ADREFP0 = 0), reference voltage (-) = V_{SS} (ADREFM = 0), target pin : ANI0, ANI1, ANI16 to ANI23, internal reference voltage, and temperature sensor output voltage

(T_A = -40 to +105°C, 2.4 V ≤ EV_{DD} = V_{DD} ≤ 5.5 V, V_{SS} = EV_{SS} = 0 V, Reference voltage (+) = V_{DD}, Reference voltage (-) = V_{SS})

Parameter	Symbol	Conditions		MIN.	TYP.	MAX.	Unit	
Resolution	RES			8		10	bit	
Overall error ^{Note 1}	AINL	10-bit resolution	2.4 V ≤ V _{DD} ≤ 5.5 V		1.2	±7.0	LSB	
Conversion time	t _{CONV}	10-bit resolution	3.6 V ≤ V _{DD} ≤ 5.5 V	2.125		39	μs	
			2.7 V ≤ V _{DD} ≤ 5.5 V	3.1875		39	μs	
			2.4 V ≤ V _{DD} ≤ 5.5 V	17		39	μs	
		10-bit resolution Target pin: Internal reference voltage, and temperature sensor output voltage (HS (high-speed main) mode)	3.6 V ≤ V _{DD} ≤ 5.5 V	2.375		39	μs	
			2.7 V ≤ V _{DD} ≤ 5.5 V	3.5625		39	μs	
			2.4 V ≤ V _{DD} ≤ 5.5 V	17		39	μs	
Zero-scale error ^{Notes 1, 2}	E _{ZS}	10-bit resolution	2.4 V ≤ V _{DD} ≤ 5.5 V			±0.60	%FSR	
Full-scale error ^{Notes 1, 2}	E _{FS}	10-bit resolution	2.4 V ≤ V _{DD} ≤ 5.5 V			±0.60	%FSR	
Integral linearity error ^{Note 1}	ILE	10-bit resolution	2.4 V ≤ V _{DD} ≤ 5.5 V			±4.0	LSB	
Differential linearity error ^{Note 1}	DLE	10-bit resolution	2.4 V ≤ V _{DD} ≤ 5.5 V			±2.0	LSB	
Analog input voltage	V _{AIN}	ANI0, ANI1		0		V _{DD}	V	
		ANI16 to ANI23		0		EV _{DD}	V	
		Internal reference voltage output (2.4 V ≤ V _{DD} ≤ 5.5 V, HS (high-speed main) mode)		V _{BGR} ^{Note 3}				V
		Temperature sensor output voltage (2.4 V ≤ V _{DD} ≤ 5.5 V, HS (high-speed main) mode)		V _{TMPS25} ^{Note 3}				V

Notes 1. Excludes quantization error (±1/2 LSB).

2. This value is indicated as a ratio (%FSR) to the full-scale value.

3. Refer to **3.6.2 Temperature sensor/internal reference voltage characteristics**.

(4) When reference voltage (+) = Internal reference voltage (ADREFP1 = 1, ADREFP0 = 0), reference voltage (-) = AV_{REFM}/ANI1 (ADREFM = 1), target pin : ANI0, ANI16 to ANI23

(T_A = -40 to +105°C, 2.4 V ≤ EV_{DD} = V_{DD} ≤ 5.5 V, V_{SS} = EV_{SS} = 0 V, Reference voltage (+) = V_{BGR} ^{Note 3}, Reference voltage (-) = AV_{REFM} ^{Note 4} = 0 V, HS (high-speed main) mode)

Parameter	Symbol	Conditions		MIN.	TYP.	MAX.	Unit
Resolution	RES			8			bit
Conversion time	t _{CONV}	8-bit resolution	2.4 V ≤ V _{DD} ≤ 5.5 V	17		39	μs
Zero-scale error ^{Notes 1, 2}	E _{ZS}	8-bit resolution	2.4 V ≤ V _{DD} ≤ 5.5 V			±0.60	%FSR
Integral linearity error ^{Note 1}	ILE	8-bit resolution	2.4 V ≤ V _{DD} ≤ 5.5 V			±2.0	LSB
Differential linearity error ^{Note 1}	DLE	8-bit resolution	2.4 V ≤ V _{DD} ≤ 5.5 V			±1.0	LSB
Analog input voltage	V _{AIN}			0		V _{BGR} ^{Note 3}	V

Notes 1. Excludes quantization error (±1/2 LSB).

2. This value is indicated as a ratio (%FSR) to the full-scale value.

3. Refer to **3.6.2 Temperature sensor/internal reference voltage characteristics**.

4. When reference voltage (-) = V_{SS}, the MAX. values are as follows.

Zero-scale error: Add ±0.35%FSR to the MAX. value when reference voltage (-) = AV_{REFM}.

Integral linearity error: Add ±0.5 LSB to the MAX. value when reference voltage (-) = AV_{REFM}.

Differential linearity error: Add ±0.2 LSB to the MAX. value when reference voltage (-) = AV_{REFM}.

3.6.2 Temperature sensor/internal reference voltage characteristics

(T_A = -40 to $+105^\circ\text{C}$, $2.4\text{ V} \leq \text{EV}_{\text{DD}} = \text{V}_{\text{DD}} \leq 5.5\text{ V}$, $\text{V}_{\text{SS}} = \text{EV}_{\text{SS}} = 0\text{ V}$, HS (high-speed main) mode)

Parameter	Symbol	Conditions	MIN.	TYP.	MAX.	Unit
Temperature sensor output voltage	V _{TMP25}	Setting ADS register = 80H, T _A = $+25^\circ\text{C}$		1.05		V
Internal reference voltage	V _{BGR}	Setting ADS register = 81H	1.38	1.45	1.5	V
Temperature coefficient	F _{VTMP25}	Temperature sensor that depends on the temperature		-3.6		mV/ $^\circ\text{C}$
Operation stabilization wait time	t _{AMP}		5			μs

3.6.3 POR circuit characteristics

(T_A = -40 to $+105^\circ\text{C}$, $\text{V}_{\text{SS}} = 0\text{ V}$)

Parameter	Symbol	Conditions	MIN.	TYP.	MAX.	Unit
Detection voltage	V _{POR}	Power supply rise time	1.45	1.51	1.57	V
	V _{PDR}	Power supply fall time	1.44	1.50	1.56	V
Minimum pulse width	T _{PW}		300			μs

Note Minimum time required for a POR reset when V_{DD} exceeds below V_{PDR}. This is also the minimum time required for a POR reset from when V_{DD} exceeds below 0.7 V to when V_{DD} exceeds V_{POR} while STOP mode is entered or the main system clock is stopped through setting bit 0 (HIOSTOP) and bit 7 (MSTOP) in the clock operation status control register (CSC).

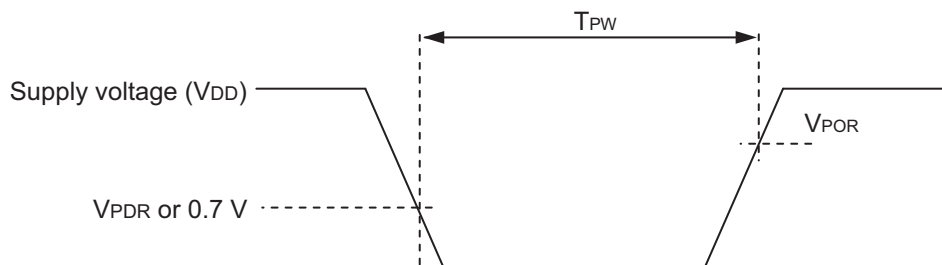

3.6.4 LVD circuit characteristics

(T_A = -40 to +105°C, V_{PDR} ≤ EV_{DD} = V_{DD} ≤ 5.5 V, V_{SS} = EV_{SS} = 0 V)

Parameter		Symbol	Conditions	MIN.	TYP.	MAX.	Unit
Detection voltage	Supply voltage level	V _{LVD0}	Power supply rise time	3.90	4.06	4.22	V
			Power supply fall time	3.83	3.98	4.13	V
		V _{LVD1}	Power supply rise time	3.60	3.75	3.90	V
			Power supply fall time	3.53	3.67	3.81	V
		V _{LVD2}	Power supply rise time	3.01	3.13	3.25	V
			Power supply fall time	2.94	3.06	3.18	V
		V _{LVD3}	Power supply rise time	2.90	3.02	3.14	V
			Power supply fall time	2.85	2.96	3.07	V
		V _{LVD4}	Power supply rise time	2.81	2.92	3.03	V
			Power supply fall time	2.75	2.86	2.97	V
		V _{LVD5}	Power supply rise time	2.70	2.81	2.92	V
			Power supply fall time	2.64	2.75	2.86	V
		V _{LVD6}	Power supply rise time	2.61	2.71	2.81	V
			Power supply fall time	2.55	2.65	2.75	V
		V _{LVD7}	Power supply rise time	2.51	2.61	2.71	V
			Power supply fall time	2.45	2.55	2.65	V
Minimum pulse width		t _{LW}		300			μs
Detection delay time						300	μs

LVD Detection Voltage of Interrupt & Reset Mode

(T_A = -40 to +105°C, V_{PDR} ≤ EV_{DD} = V_{DD} ≤ 5.5 V, V_{SS} = EV_{SS} = 0 V)

Parameter	Symbol	Conditions	MIN.	TYP.	MAX.	Unit		
Interrupt and reset mode	V _{LVDD0}	V _{POC2} , V _{POC1} , V _{POC0} = 0, 1, 1, falling reset voltage		2.64	2.75	2.86	V	
	V _{LVDD1}		LVIS1, LVIS0 = 1, 0	Rising release reset voltage	2.81	2.92	3.03	V
				Falling interrupt voltage	2.75	2.86	2.97	V
	V _{LVDD2}		LVIS1, LVIS0 = 0, 1	Rising release reset voltage	2.90	3.02	3.14	V
				Falling interrupt voltage	2.85	2.96	3.07	V
	V _{LVDD3}		LVIS1, LVIS0 = 0, 0	Rising release reset voltage	3.90	4.06	4.22	V
				Falling interrupt voltage	3.83	3.98	4.13	V

3.6.5 Power supply voltage rising slope characteristics

(T_A = -40 to +105°C, V_{SS} = 0 V)

Parameter	Symbol	Conditions	MIN.	TYP.	MAX.	Unit
Power supply voltage rising slope	S _{VDD}				54	V/ms

Caution Make sure to keep the internal reset state by the LVD circuit or an external reset until V_{DD} reaches the operating voltage range shown in 3.4 AC Characteristics.

3.7 LCD Characteristics

3.7.1 Resistance division method

(1) Static display mode

(T_A = -40 to +105°C, V_{L4} (MIN.) ≤ V_{DD}^{Note} ≤ 5.5 V, V_{SS} = 0 V)

Parameter	Symbol	Conditions	MIN.	TYP.	MAX.	Unit
LCD drive voltage	V _{L4}		2.0		V _{DD}	V

Note Must be 2.4 V or higher.

(2) 1/2 bias method, 1/4 bias method

(T_A = -40 to +105°C, V_{L4} (MIN.) ≤ V_{DD} ≤ 5.5 V, V_{SS} = 0 V)

Parameter	Symbol	Conditions	MIN.	TYP.	MAX.	Unit
LCD drive voltage	V _{L4}		2.7		V _{DD}	V

(3) 1/3 bias method

(T_A = -40 to +105°C, V_{L4} (MIN.) ≤ V_{DD} ≤ 5.5 V, V_{SS} = 0 V)

Parameter	Symbol	Conditions	MIN.	TYP.	MAX.	Unit
LCD drive voltage	V _{L4}		2.5		V _{DD}	V

3.7.2 Internal voltage boosting method

(1) 1/3 bias method

(T_A = -40 to +105°C, 2.4 V ≤ V_{DD} ≤ 5.5 V, V_{SS} = 0 V)

Parameter	Symbol	Conditions	MIN.	TYP.	MAX.	Unit	
LCD output voltage variation range	V _{L1}	C1 to C4 ^{Note 1} = 0.47 μF	VLCD = 04H	0.90	1.00	1.08	V
			VLCD = 05H	0.95	1.05	1.13	V
			VLCD = 06H	1.00	1.10	1.18	V
			VLCD = 07H	1.05	1.15	1.23	V
			VLCD = 08H	1.10	1.20	1.28	V
			VLCD = 09H	1.15	1.25	1.33	V
			VLCD = 0AH	1.20	1.30	1.38	V
			VLCD = 0BH	1.25	1.35	1.43	V
			VLCD = 0CH	1.30	1.40	1.48	V
			VLCD = 0DH	1.35	1.45	1.53	V
			VLCD = 0EH	1.40	1.50	1.58	V
			VLCD = 0FH	1.45	1.55	1.63	V
			VLCD = 10H	1.50	1.60	1.68	V
			VLCD = 11H	1.55	1.65	1.73	V
VLCD = 12H	1.60	1.70	1.78	V			
VLCD = 13H	1.65	1.75	1.83	V			
Doubler output voltage	V _{L2}	C1 to C4 ^{Note 1} = 0.47 μF	2 V _{L1} -0.1	2 V _{L1}	2 V _{L1}	V	
Tripler output voltage	V _{L4}	C1 to C4 ^{Note 1} = 0.47 μF	3 V _{L1} -0.15	3 V _{L1}	3 V _{L1}	V	
Reference voltage setup time ^{Note 2}	t _{VWAIT1}		5			ms	
Voltage boost wait time ^{Note 3}	t _{VWAIT2}	C1 to C4 ^{Note 1} = 0.47 μF	500			ms	

Notes 1. This is a capacitor that is connected between voltage pins used to drive the LCD.

C1: A capacitor connected between CAPH and CAPL

C2: A capacitor connected between V_{L1} and GND

C3: A capacitor connected between V_{L2} and GND

C4: A capacitor connected between V_{L4} and GND

C1 = C2 = C3 = C4 = 0.47 μF ± 30%

- This is the time required to wait from when the reference voltage is specified by using the VLCD register (or when the internal voltage boosting method is selected [by setting the MDSET1 and MDSET0 bits of the LCDM0 register to 01B] if the default value reference voltage is used) until voltage boosting starts (VLCON = 1).
- This is the wait time from when voltage boosting is started (VLCON = 1) until display is enabled (LCDON = 1).

(2) 1/4 bias method

(T_A = -40 to +105°C, 2.4 V ≤ V_{DD} ≤ 5.5 V, V_{SS} = 0 V)

Parameter	Symbol	Conditions	MIN.	TYP.	MAX.	Unit	
LCD output voltage variation range	V _{L1} ^{Note 4}	C1 to C5 ^{Note 1} = 0.47 μF	VLCD = 04H	0.90	1.00	1.08	V
			VLCD = 05H	0.95	1.05	1.13	V
			VLCD = 06H	1.00	1.10	1.18	V
			VLCD = 07H	1.05	1.15	1.23	V
			VLCD = 08H	1.10	1.20	1.28	V
			VLCD = 09H	1.15	1.25	1.33	V
			VLCD = 0AH	1.20	1.30	1.38	V
			VLCD = 0BH	1.25	1.35	1.43	V
			VLCD = 0CH	1.30	1.40	1.48	V
			VLCD = 0DH	1.35	1.45	1.53	V
			VLCD = 0EH	1.40	1.50	1.58	V
			VLCD = 0FH	1.45	1.55	1.63	V
			VLCD = 10H	1.50	1.60	1.68	V
			VLCD = 11H	1.55	1.65	1.73	V
VLCD = 12H	1.60	1.70	1.78	V			
VLCD = 13H	1.65	1.75	1.83	V			
Doubler output voltage	V _{L2}	C1 to C5 ^{Note 1} = 0.47 μF	2 V _{L1} - 0.08	2 V _{L1}	2 V _{L1}	V	
Tripler output voltage	V _{L3}	C1 to C5 ^{Note 1} = 0.47 μF	3 V _{L1} - 0.12	3 V _{L1}	3 V _{L1}	V	
Quadruply output voltage	V _{L4} ^{Note 4}	C1 to C5 ^{Note 1} = 0.47 μF	4 V _{L1} - 0.16	4 V _{L1}	4 V _{L1}	V	
Reference voltage setup time ^{Note 2}	t _{WAIT1}		5			ms	
Voltage boost wait time ^{Note 3}	t _{WAIT2}	C1 to C5 ^{Note 1} = 0.47 μF	500			ms	

Notes 1. This is a capacitor that is connected between voltage pins used to drive the LCD.

C1: A capacitor connected between CAPH and CAPL

C2: A capacitor connected between V_{L1} and GND

C3: A capacitor connected between V_{L2} and GND

C4: A capacitor connected between V_{L3} and GND

C5: A capacitor connected between V_{L4} and GND

C1 = C2 = C3 = C4 = C5 = 0.47 μF ± 30%

- This is the time required to wait from when the reference voltage is specified by using the VLCD register (or when the internal voltage boosting method is selected [by setting the MDSET1 and MDSET0 bits of the LCDM0 register to 01B] if the default value reference voltage is used) until voltage boosting starts (VLCON = 1).
- This is the wait time from when voltage boosting is started (VLCON = 1) until display is enabled (LCDON = 1).
- V_{L4} must be 5.5 V or lower.

3.7.3 Capacitor split method

1/3 bias method

(T_A = -40 to +105°C, 2.4 V ≤ V_{DD} ≤ 5.5 V, V_{SS} = 0 V)

Parameter	Symbol	Conditions	MIN.	TYP.	MAX.	Unit
V _{L4} voltage	V _{L4}	C1 to C4 = 0.47 μF ^{Note 2}		V _{DD}		V
V _{L2} voltage	V _{L2}	C1 to C4 = 0.47 μF ^{Note 2}	2/3 V _{L4} - 0.1	2/3 V _{L4}	2/3 V _{L4} + 0.1	V
V _{L1} voltage	V _{L1}	C1 to C4 = 0.47 μF ^{Note 2}	1/3 V _{L4} - 0.1	1/3 V _{L4}	1/3 V _{L4} + 0.1	V
Capacitor split wait time ^{Note 1}	t _{WAIT}		100			ms

Notes 1. This is the wait time from when voltage bucking is started (VLCON = 1) until display is enabled (LCDON = 1).

2. This is a capacitor that is connected between voltage pins used to drive the LCD.

C1: A capacitor connected between CAPH and CAPL

C2: A capacitor connected between V_{L1} and GND

C3: A capacitor connected between V_{L2} and GND

C4: A capacitor connected between V_{L4} and GND

C1 = C2 = C3 = C4 = 0.47 μF±30%

3.8 RAM Data Retention Characteristics

(T_A = -40 to +105°C, V_{SS} = 0 V)

Parameter	Symbol	Conditions	MIN.	TYP.	MAX.	Unit
Data retention supply voltage	V _{DDDR}		1.44 ^{Note}		5.5	V

Note This depends on the POR detection voltage. For a falling voltage, data in RAM are retained until the voltage reaches the level that triggers a POR reset but not once it reaches the level at which a POR reset is generated.

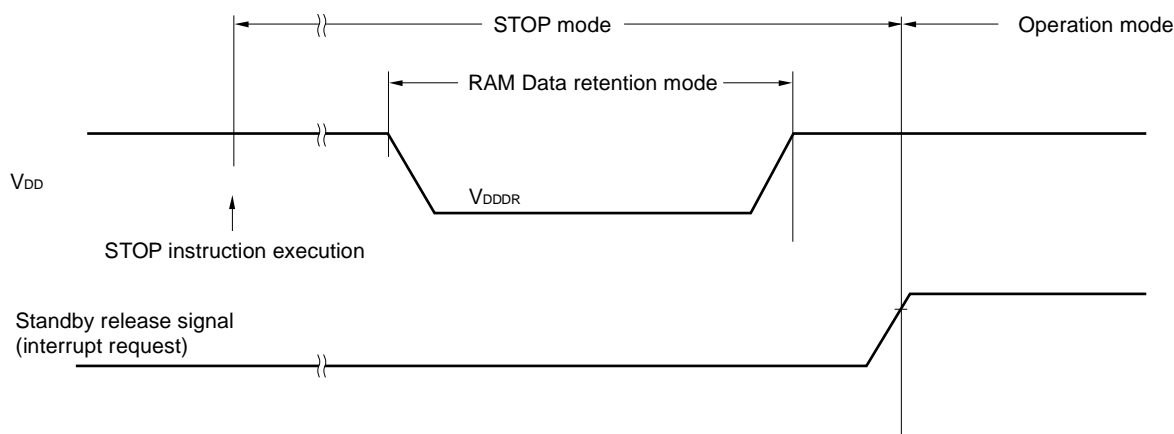

3.9 Flash Memory Programming Characteristics

(T_A = -40 to +105°C, 2.4 V ≤ EV_{DD} = V_{DD} ≤ 5.5 V, V_{SS} = EV_{SS} = 0 V)

Parameter	Symbol	Conditions	MIN.	TYP.	MAX.	Unit
System clock frequency	f _{CLK}	1.8 V ≤ V _{DD} ≤ 5.5 V	1		24	MHz
Number of code flash rewrites <small>Notes 1, 2, 3</small>	C _{enwr}	Retained for 20 years T _A = 85°C ^{Note 4}	1,000			Times
Number of data flash rewrites <small>Notes 1, 2, 3</small>		Retained for 1 year T _A = 25°C ^{Note 4}		1,000,000		
		Retained for 5 years T _A = 85°C ^{Note 4}	100,000			
		Retained for 20 years T _A = 85°C ^{Note 4}	10,000			

- Notes**
- 1 erase + 1 write after the erase is regarded as 1 rewrite.
The retaining years are until next rewrite after the rewrite.
 2. When using flash memory programmer and Renesas Electronics self programming library
 3. This characteristic indicates the flash memory characteristic and based on Renesas Electronics reliability test.
 4. This temperature is the average value at which data are retained.

3.10 Dedicated Flash Memory Programmer Communication (UART)

(T_A = -40 to +105°C, 2.4 V ≤ EV_{DD} = V_{DD} ≤ 5.5 V, V_{SS} = EV_{SS} = 0 V)

Parameter	Symbol	Conditions	MIN.	TYP.	MAX.	Unit
Transfer rate		During flash memory programming	115,200		1,000,000	bps

3.11 Timing Specifications for Switching Flash Memory Programming Modes

(T_A = -40 to +105°C, 2.4 V ≤ V_{DD} = V_{DD} ≤ 5.5 V, V_{SS} = EV_{SS} = 0 V)

Parameter	Symbol	Conditions	MIN.	TYP.	MAX.	Unit
Time to complete the communication for the initial setting after the external reset is released	t _{SUINIT}	POR and LVD reset must be released before the external reset is released.			100	ms
Time to release the external reset after the TOOL0 pin is set to the low level	t _{SU}	POR and LVD reset must be released before the external reset is released.	10			μs
Time to hold the TOOL0 pin at the low level after the external reset is released (excluding the processing time of the firmware to control the flash memory)	t _{HD}	POR and LVD reset must be released before the external reset is released.	1			ms

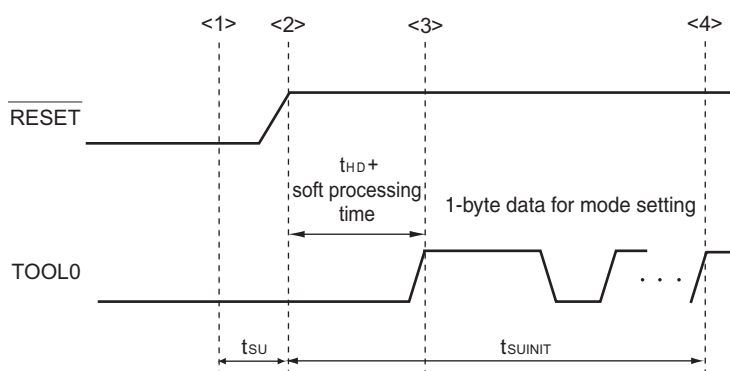

- <1> The low level is input to the TOOL0 pin.
- <2> The external reset is released (POR and LVD reset must be released before the external reset is released.).
- <3> The TOOL0 pin is set to the high level.
- <4> Setting of the flash memory programming mode by UART reception and complete the baud rate setting.

Remark t_{SUINIT}: Communication for the initial setting must be completed within 100 ms after the external reset is released during this period.

t_{SU}: Time to release the external reset after the TOOL0 pin is set to the low level

t_{HD}: Time to hold the TOOL0 pin at the low level after the external reset is released (excluding the processing time of the firmware to control the flash memory)

4. PACKAGE DRAWINGS

4.1 32-pin Package

JEITA Package Code	RENESAS Code	Previous Code	MASS (TYP.) [g]
P-LQFP32-7x7-0.80	PLQP0032GB-A	P32GA-80-GBT-1	0.2

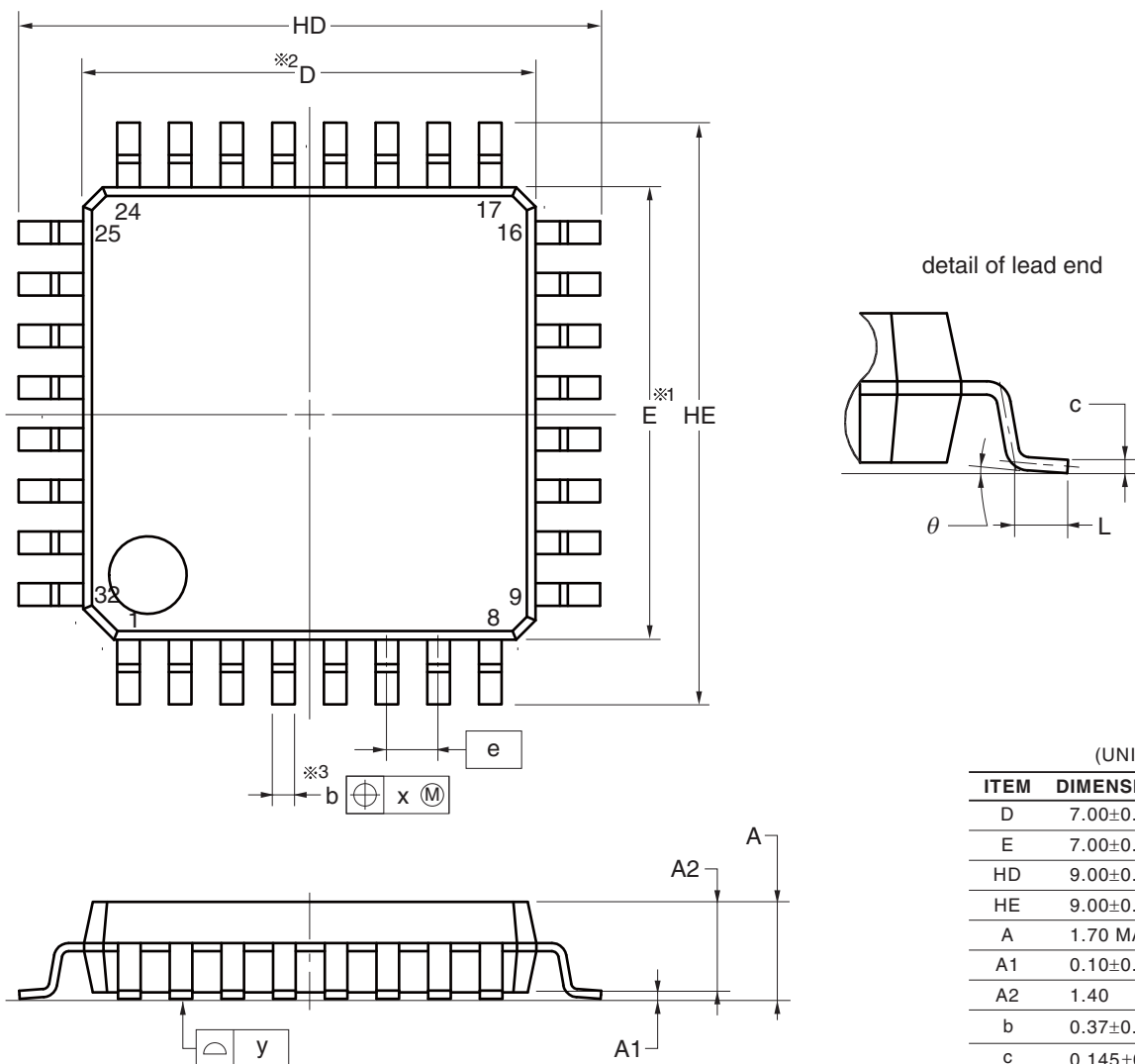

(UNIT:mm)

ITEM	DIMENSIONS
D	7.00±0.10
E	7.00±0.10
HD	9.00±0.20
HE	9.00±0.20
A	1.70 MAX.
A1	0.10±0.10
A2	1.40
b	0.37±0.05
c	0.145±0.055
L	0.50±0.20
θ	0° to 8°
e	0.80
x	0.20
y	0.10

NOTE

1. Dimensions “ $\ast 1$ ” and “ $\ast 2$ ” do not include mold flash.
2. Dimension “ $\ast 3$ ” does not include trim offset.

4.2 44-pin Package

JEITA Package Code	RENESAS Code	Previous Code	MASS (TYP.) [g]
P-LQFP44-10x10-0.80	PLQP0044GC-A	P44GB-80-UES-2	0.36

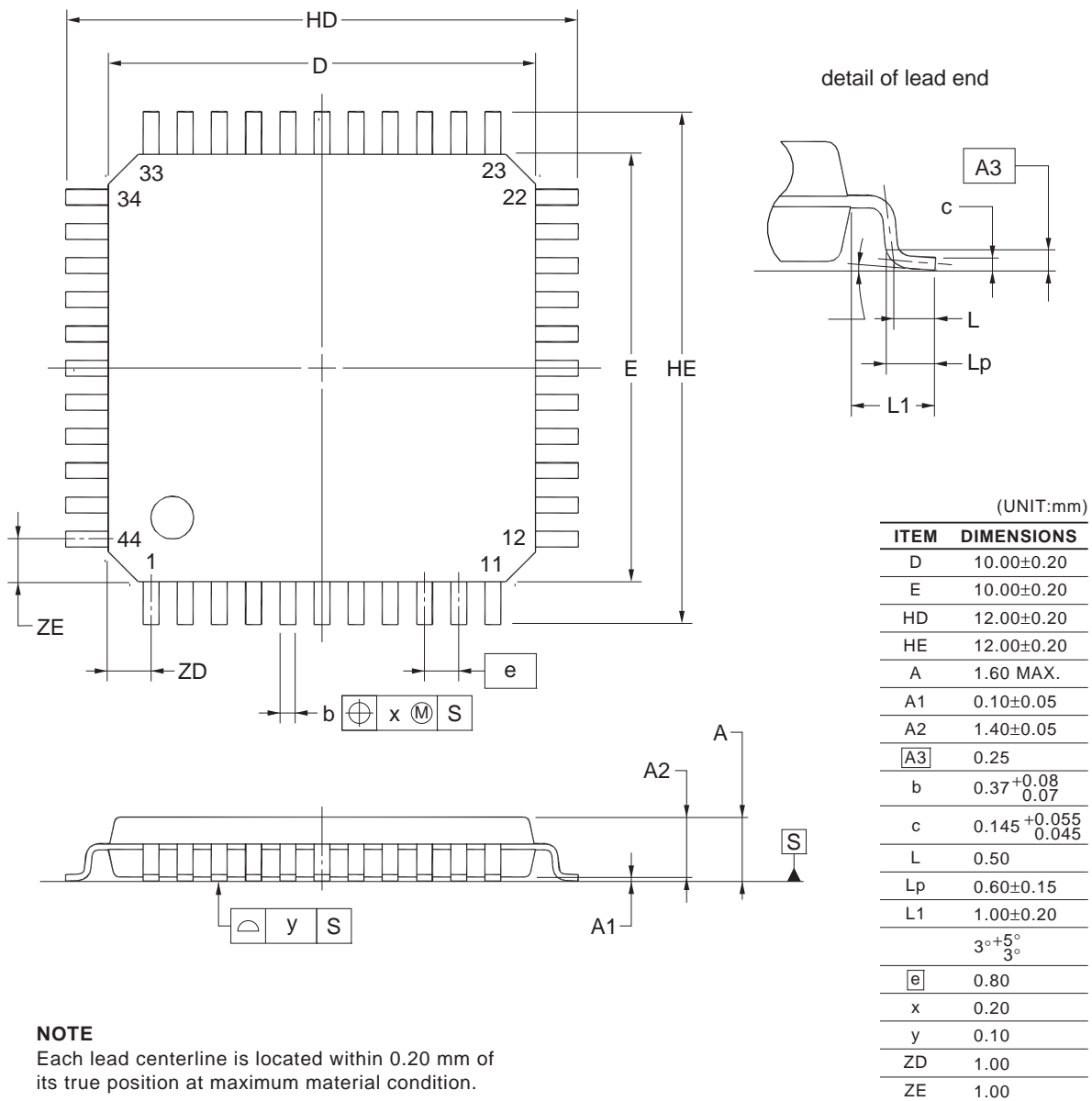

NOTE
Each lead centerline is located within 0.20 mm of its true position at maximum material condition.

JEITA Package Code	RENESAS Code	Previous Code	MASS[Typ.]
P-LQFP44-10x10-0.80	PLQP0044GC-D	—	0.36g

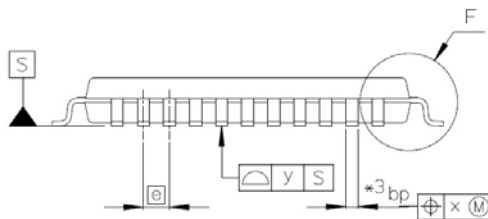
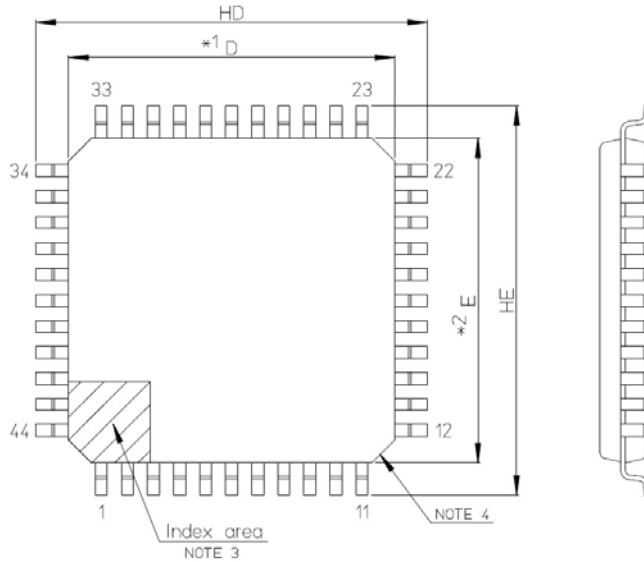

- NOTE)
1. DIMENSIONS *1 AND *2 DO NOT INCLUDE MOLD FLASH.
 2. DIMENSION *3 DOES NOT INCLUDE TRIM OFFSET.
 3. PIN 1 VISUAL INDEX FEATURE MAY VARY, BUT MUST BE LOCATED WITHIN THE HATCHED AREA.
 4. CHAMFERS AT CORNERS ARE OPTIONAL; SIZE MAY VARY.

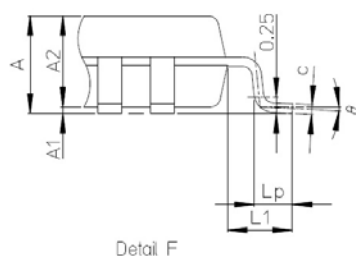

Reference Symbol	Dimension in Millimeters		
	Min	Nom	Max
D	9.8	10.0	10.2
E	9.8	10.0	10.2
A2	—	1.4	—
HD	11.8	12.0	12.2
HE	11.8	12.0	12.2
A	—	—	1.6
A1	0.05	—	0.15
bp	0.22	0.37	0.45
c	0.09	—	0.20
∅	0°	3.5°	8°
e	—	0.80	—
x	—	—	0.20
y	—	—	0.10
Lp	0.45	0.6	0.75
L1	—	1.0	—

4.3 48-pin Package

JEITA Package Code	RENESAS Code	Previous Code	MASS (TYP.) [g]
P-LFQFP48-7x7-0.50	PLQP0048KF-A	P48GA-50-8EU-1	0.16

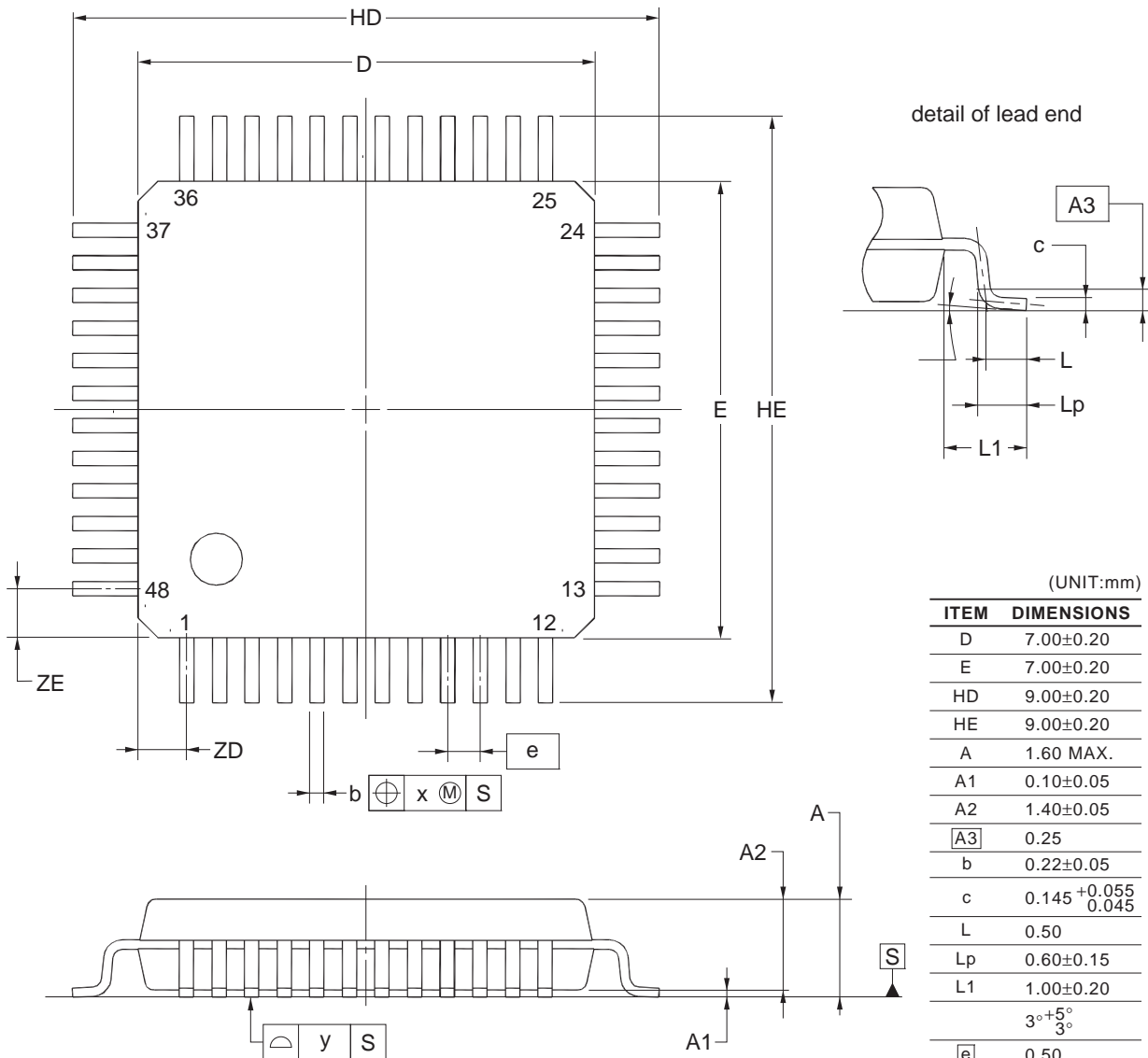

(UNIT:mm)

ITEM	DIMENSIONS
D	7.00±0.20
E	7.00±0.20
HD	9.00±0.20
HE	9.00±0.20
A	1.60 MAX.
A1	0.10±0.05
A2	1.40±0.05
A3	0.25
b	0.22±0.05
c	0.145 ^{+0.055} _{0.045}
L	0.50
Lp	0.60±0.15
L1	1.00±0.20
	3°+5° 3°
e	0.50
x	0.08
y	0.08
ZD	0.75
ZE	0.75

NOTE
Each lead centerline is located within 0.08 mm of its true position at maximum material condition.

JEITA Package Code	RENESAS Code	Previous Code	MASS (Typ) [g]
P-LFQFP48-7x7-0.50	PLQP0048KB-B	—	0.2

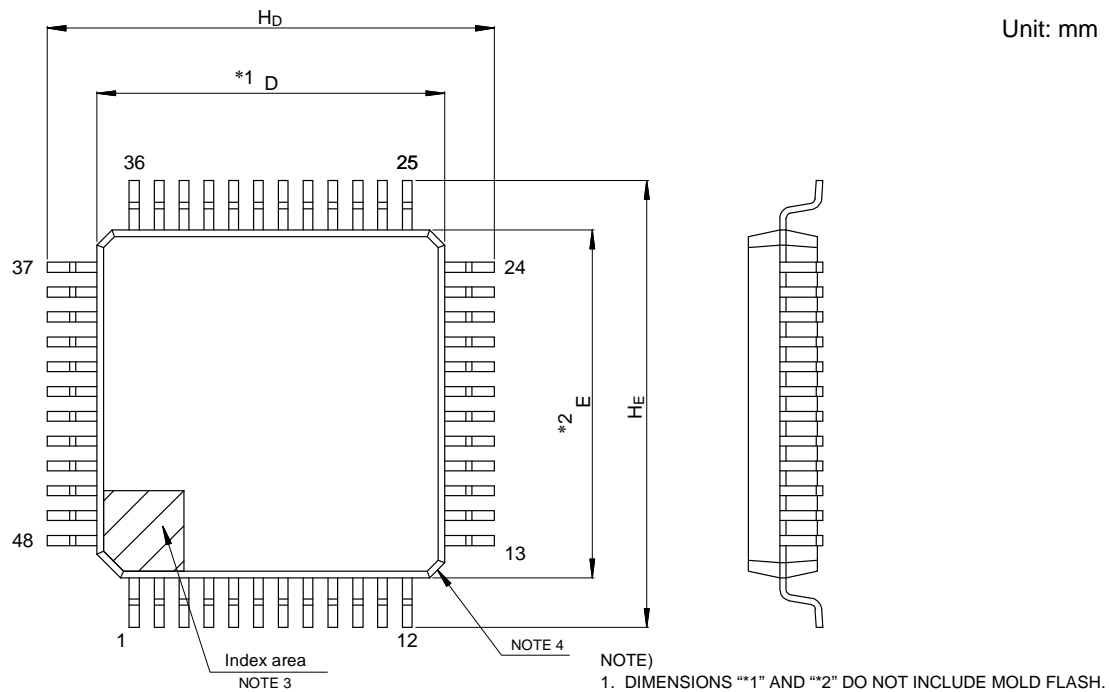

- NOTE)
1. DIMENSIONS “*1” AND “*2” DO NOT INCLUDE MOLD FLASH.
 2. DIMENSION “*3” DOES NOT INCLUDE TRIM OFFSET.
 3. PIN 1 VISUAL INDEX FEATURE MAY VARY, BUT MUST BE LOCATED WITHIN THE HATCHED AREA.
 4. CHAMFERS AT CORNERS ARE OPTIONAL, SIZE MAY VARY.

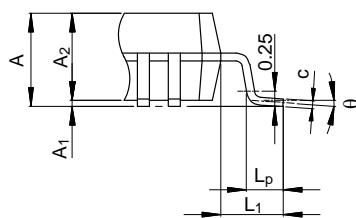
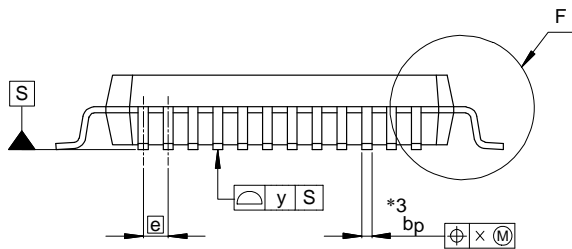

Detail F

Reference Symbol	Dimensions in millimeters		
	Min	Nom	Max
D	6.9	7.0	7.1
E	6.9	7.0	7.1
A ₂	—	1.4	—
H _D	8.8	9.0	9.2
H _E	8.8	9.0	9.2
A	—	—	1.7
A ₁	0.05	—	0.15
b _p	0.17	0.20	0.27
c	0.09	—	0.20
θ	0°	3.5°	8°
⓪	—	0.5	—
x	—	—	0.08
y	—	—	0.08
L _p	0.45	0.6	0.75
L ₁	—	1.0	—

© 2015 Renesas Electronics Corporation. All rights reserved.

4.4 52-pin Package

JEITA Package Code	RENESAS Code	Previous Code	MASS (TYP.) [g]
P-LQFP52-10x10-0.65	PLQP0052JA-A	P52GB-65-GBS-1	0.3

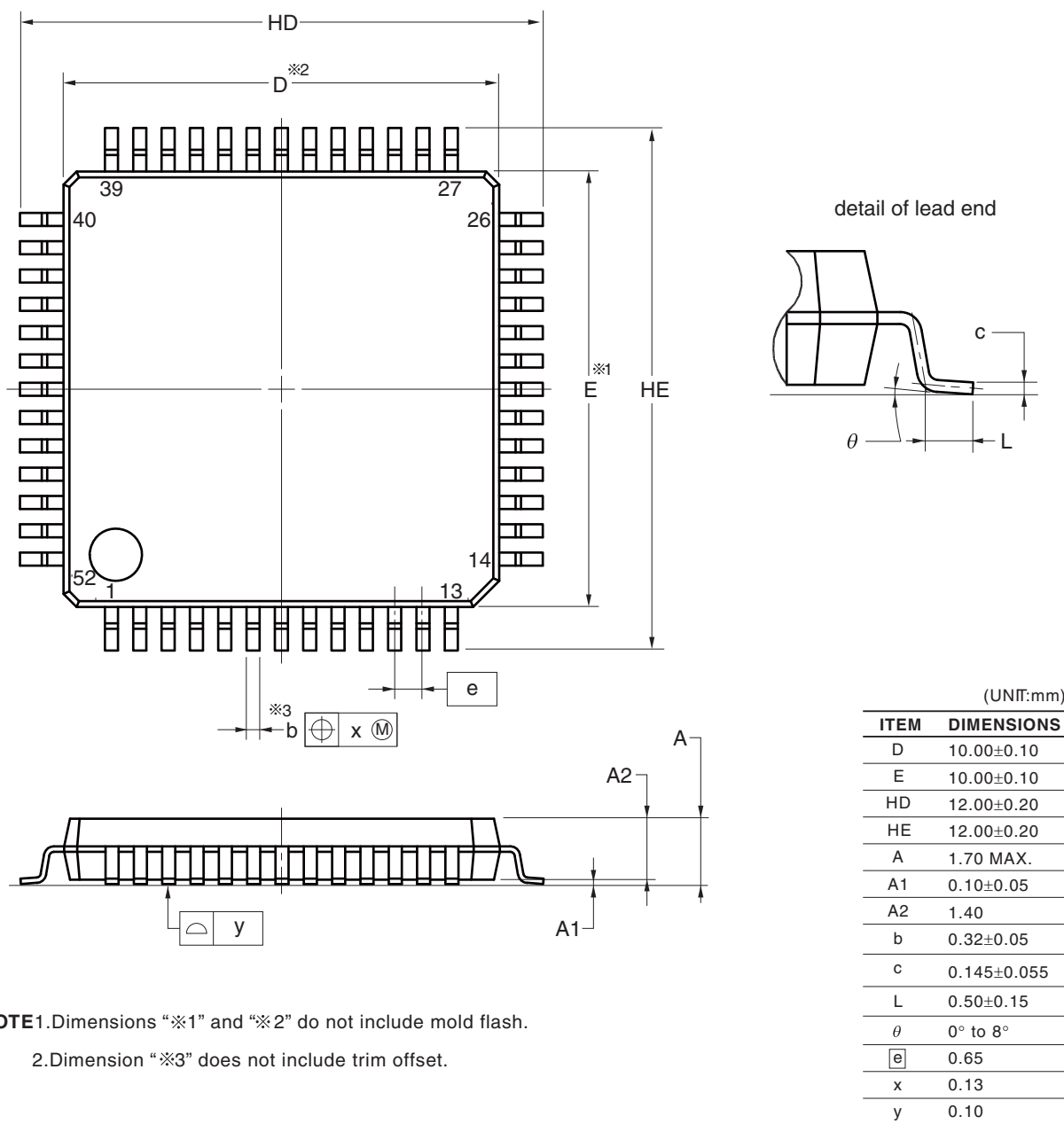

NOTE1. Dimensions “※1” and “※2” do not include mold flash.
 2. Dimension “※3” does not include trim offset.

© 2012 Renesas Electronics Corporation. All rights reserved.

4.5 64-pin Package

JEITA Package Code	RENESAS Code	Previous Code	MASS (TYP.) [g]
P-LQFP64-12x12-0.65	PLQP0064JA-A	P64GK-65-UET-2	0.51

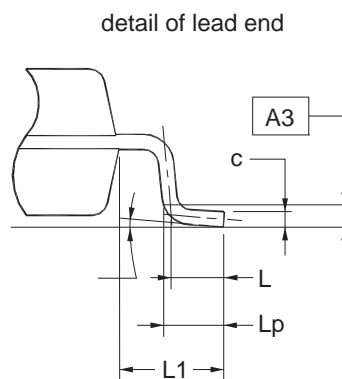
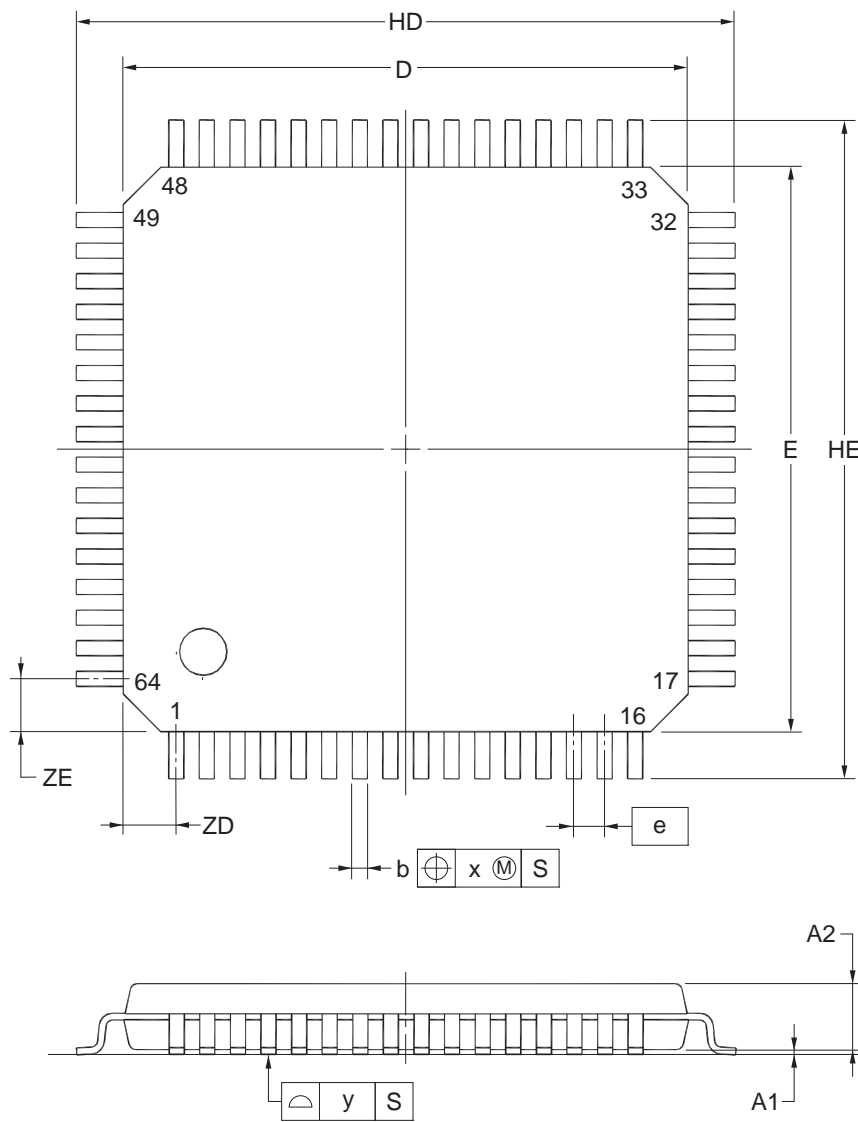

(UNIT:mm)

ITEM	DIMENSIONS
D	12.00±0.20
E	12.00±0.20
HD	14.00±0.20
HE	14.00±0.20
A	1.60 MAX.
A1	0.10±0.05
A2	1.40±0.05
A3	0.25
b	0.32 ^{+0.08} / _{0.07}
c	0.145 ^{+0.055} / _{0.045}
L	0.50
Lp	0.60±0.15
L1	1.00±0.20
	3° ^{+5°} / _{3°}
e	0.65
x	0.13
y	0.10
ZD	1.125
ZE	1.125

NOTE
 Each lead centerline is located within 0.13 mm of its true position at maximum material condition.

JEITA Package Code	RENESAS Code	Previous Code	MASS (TYP.) [g]
P-LFQFP64-10x10-0.50	PLQP0064KF-A	P64GB-50-UEU-2	0.35

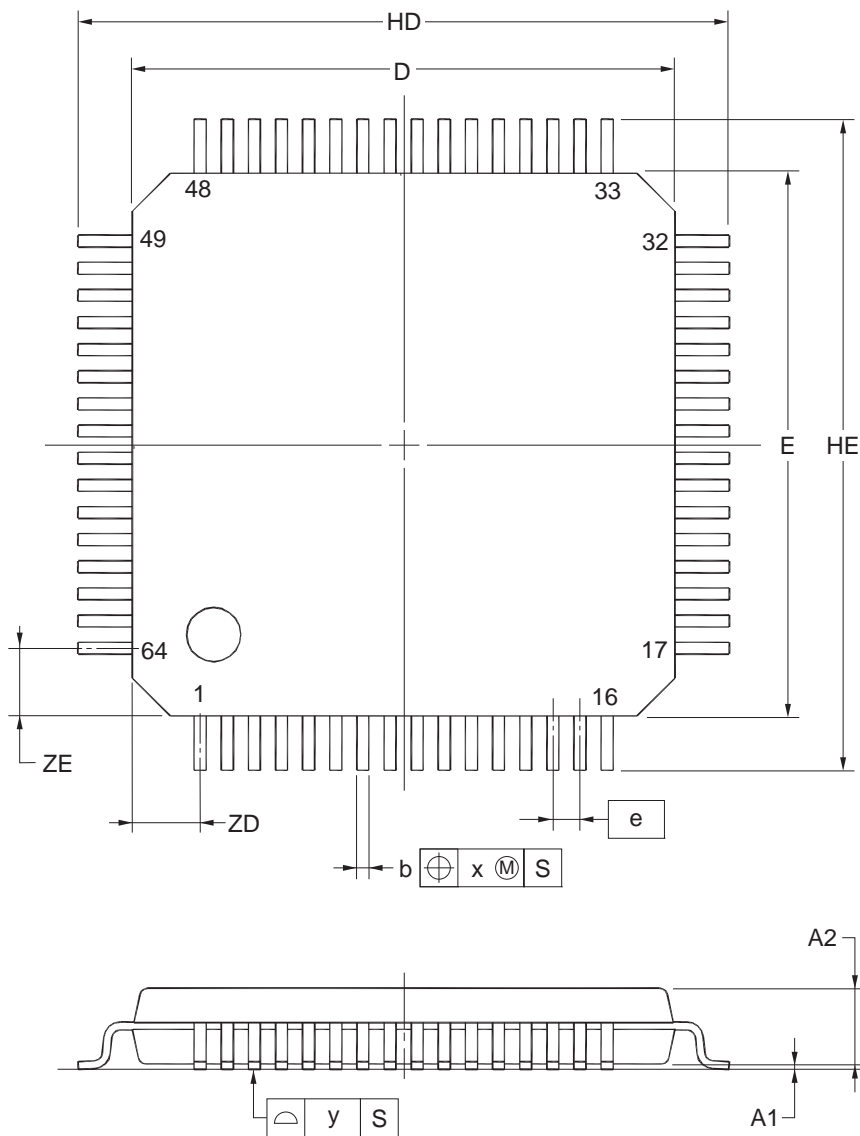

detail of lead end

(UNIT:mm)

ITEM	DIMENSIONS
D	10.00±0.20
E	10.00±0.20
HD	12.00±0.20
HE	12.00±0.20
A	1.60 MAX.
A1	0.10±0.05
A2	1.40±0.05
A3	0.25
b	0.22±0.05
c	0.145 ^{+0.055} / _{0.045}
L	0.50
Lp	0.60±0.15
L1	1.00±0.20
	3°+5° 3°
e	0.50
x	0.08
y	0.08
ZD	1.25
ZE	1.25

NOTE

Each lead centerline is located within 0.08 mm of its true position at maximum material condition.

©2012 Renesas Electronics Corporation. All rights reserved.

JEITA Package Code	RENESAS Code	Previous Code	MASS (Typ) [g]
P-LFQFP64-10x10-0.50	PLQP0064KB-C	—	0.3

Unit: mm

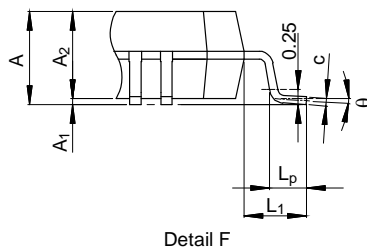
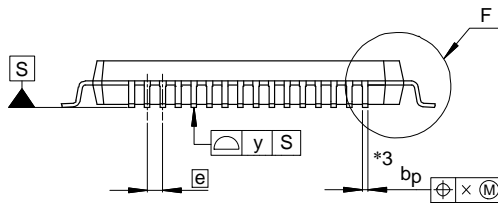
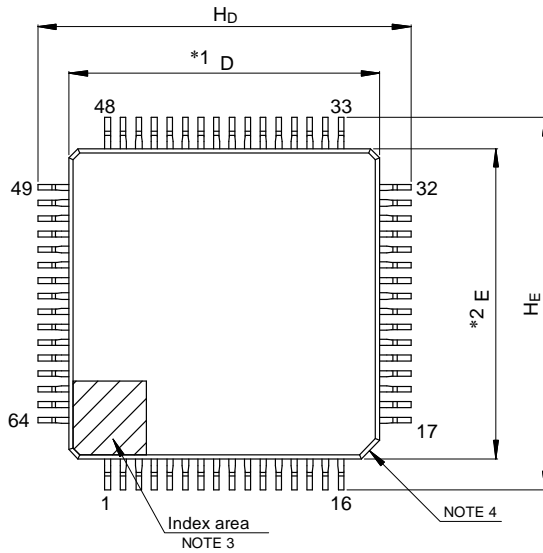

NOTE)

1. DIMENSIONS “*1” AND “*2” DO NOT INCLUDE MOLD FLASH.
2. DIMENSION “*3” DOES NOT INCLUDE TRIM OFFSET.
3. PIN 1 VISUAL INDEX FEATURE MAY VARY, BUT MUST BE LOCATED WITHIN THE HATCHED AREA.
4. CHAMFERS AT CORNERS ARE OPTIONAL, SIZE MAY VARY.

Reference Symbol	Dimensions in millimeters		
	Min	Nom	Max
D	9.9	10.0	10.1
E	9.9	10.0	10.1
A ₂	—	1.4	—
H _D	11.8	12.0	12.2
H _E	11.8	12.0	12.2
A	—	—	1.7
A ₁	0.05	—	0.15
b _p	0.15	0.20	0.27
c	0.09	—	0.20
θ	0°	3.5°	8°
e	—	0.5	—
x	—	—	0.08
y	—	—	0.08
L _p	0.45	0.6	0.75
L ₁	—	1.0	—

© 2015 Renesas Electronics Corporation. All rights reserved.

JEITA Package Code	RENESAS Code	Previous Code	MASS (Typ) [g]
P-HWQFN64-8x8-0.40	PWQN0064LA-A	P64K8-40-9B5-4	0.16

Unit: mm

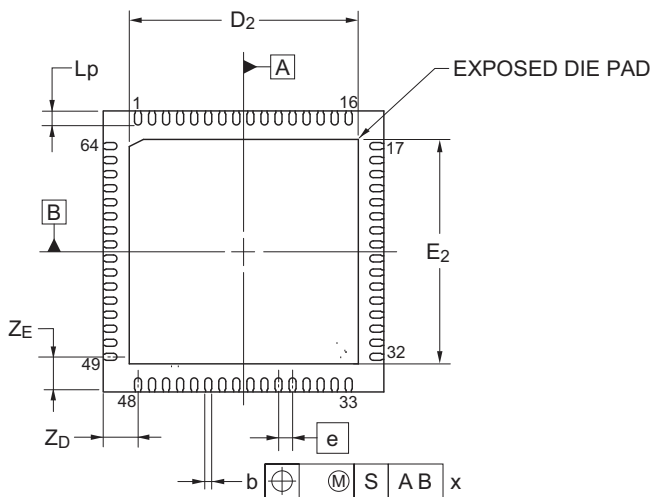
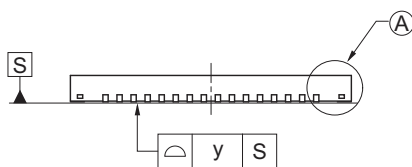
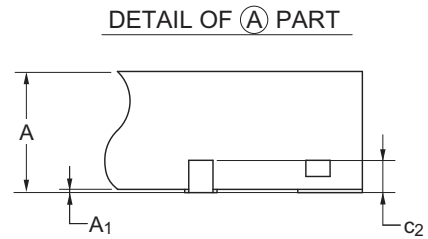
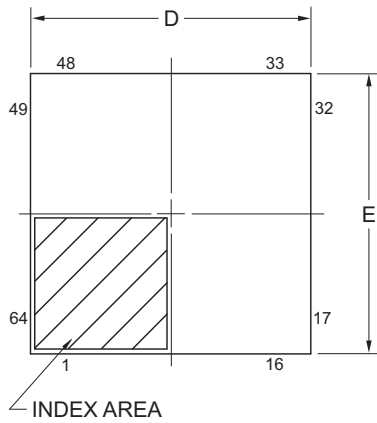

Reference Symbol	Dimensions in millimeters		
	Min	Nom	Max
D	7.95	8.00	8.05
E	7.95	8.00	8.05
A	—	—	0.80
A ₁	0.00	—	—
b	0.17	0.20	0.23
e	—	0.40	—
L _p	0.30	0.40	0.50
x	—	—	0.05
y	—	—	0.05
Z _D	—	1.00	—
Z _E	—	1.00	—
c ₂	0.15	0.20	0.25
D ₂	—	6.50	—
E ₂	—	6.50	—

© 2015 Renesas Electronics Corporation. All rights reserved.

<R>

JEITA Package code	RENESAS code	MASS(TYP.)[g]
P-HWQFN064-8x8-0.40	PWQN0064LB-A	0.18

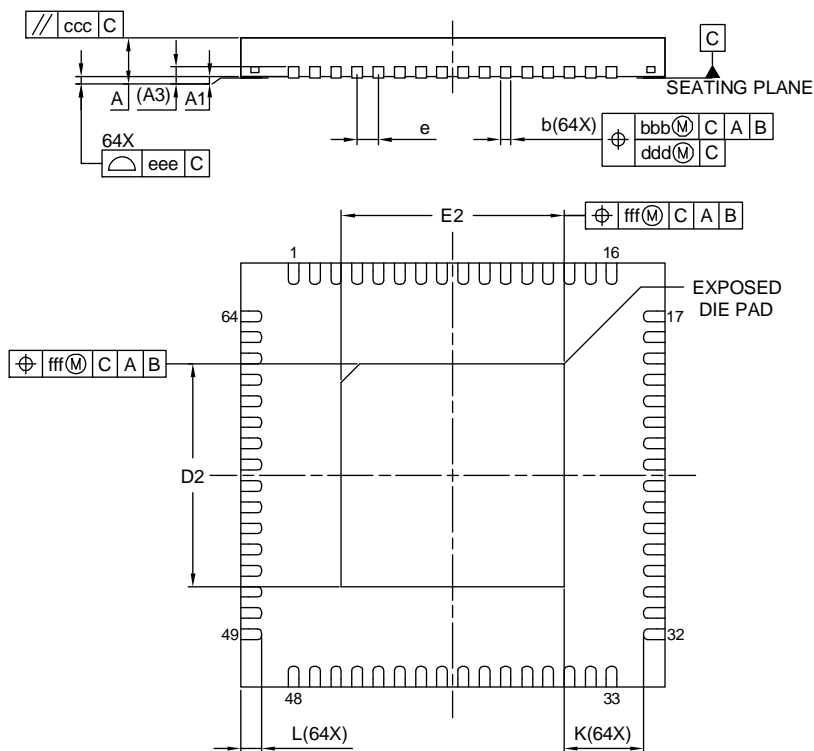
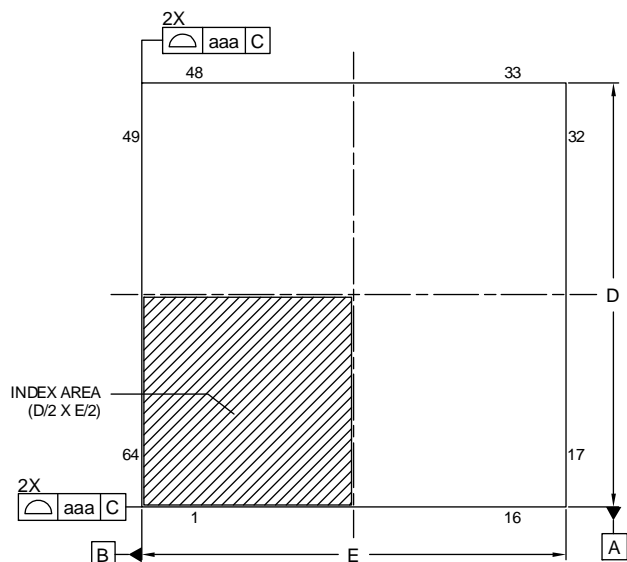

Reference Symbol	Dimension in Millimeters		
	Min.	Nom.	Max.
A	—	—	0.80
A ₁	0.00	0.02	0.05
A ₃	0.203 REF.		
b	0.15	0.20	0.25
D	8.00 BSC		
E	8.00 BSC		
e	0.40 BSC		
L	0.35	0.40	0.45
K	0.20	—	—
D ₂	4.15	4.20	4.25
E ₂	4.15	4.20	4.25
aaa	0.10		
bbb	0.07		
ccc	0.10		
ddd	0.05		
eee	0.08		
fff	0.10		

Revision History

RL78/L12 Datasheet

Rev.	Date	Description	
		Page	Summary
0.01	Feb 20, 2012	-	First Edition issued
0.02	Sep 26, 2012	7, 8	Modification of caution 2 in 1.3.5 64-pin products
		15	Modification of I/O port in 1.6 Outline of Functions
		-	Modification of 2. ELECTRICAL SPECIFICATIONS (TARGET)
		-	Update of package drawings in 3. PACKAGE DRAWINGS
1.00	Jan 31, 2013	11 to 15	Modification of 1.5 Block Diagram
		16	Modification of Note 2 in 1.6 Outline of Functions
		17	Modification of 1.6 Outline of Functions
		-	Deletion of target in 2. ELECTRICAL SPECIFICATIONS
		18	Addition of caution 2 to 2. ELECTRICAL SPECIFICATIONS
		19	Addition of description, note 3, and remark 2 to 2.1 Absolute Maximum Ratings
		20	Modification of description and addition of note to 2.1 Absolute Maximum Ratings
		22, 23	Modification of 2.2 Oscillator Characteristics
		30	Modification of notes 1 to 4 in 2.3.2 Supply current characteristics
		32	Modification of notes 1, 3 to 6, 8 in 2.3.2 Supply current characteristics
		34	Modification of notes 7, 9, 11, and addition of notes 8, 12 to 2.3.2 Supply current characteristics
		36	Addition of description to 2.4 AC Characteristics
		38, 40 to 42, 44 to 46, 48 to 52, 54, 55	Modification of 2.5.1 Serial array unit
		57, 58	Modification of 2.5.2 Serial interface IICA
		62	Modification of 2.6.2 Temperature sensor/internal reference voltage characteristics
		64	Addition of note and caution in 2.6.5 Supply voltage rise time
		69	Modification of 2.8 Data Memory STOP Mode Low Supply Voltage Data Retention Characteristics
		69	Modification of conditions in 2.9 Timing Specs for Switching Flash Memory Programming Modes
		70	Modification of 2.10 Timing Specifications for Switching Flash Memory Programming Modes
		2.00	Jan 10, 2014
3	Modification of Figure 1-1		
4	Modification of part number, note, and caution		
5 to 10	Deletion of COMEXP pin in 1.3.1 to 1.3.5.		
11	Modification of description in 1.4 Pin Identification		
12 to 16	Deletion of COMEXP pin in 1.5.1 to 1.5.5		
17	Modification of table and note 2 in 1.6 Outline of Functions		
20	Modification of description in Absolute Maximum Ratings ($T_A = 25^\circ\text{C}$) (1/3)		
21	Modification of description and note 2 in Absolute Maximum Ratings ($T_A = 25^\circ\text{C}$) (2/3)		
23	Modification of table, note, caution, and remark in 2.2.1 X1, XT1 oscillator characteristics		
23	Modification of table in 2.2.2 On-chip oscillator characteristics		
24	Modification of table, notes 2 and 3 in 2.3.1 Pin characteristics (1/5)		
25	Modification of notes 1 and 3 in 2.3.1 Pin characteristics (2/5)		
30	Modification of notes 1 and 4 in 2.3.2 Supply current characteristics (1/3)		
31, 32	Modification of table, notes 1, 5, and 6 in 2.3.2 Supply current characteristics (2/3)		
33, 34	Modification of table, notes 1, 3, 4, and 5 to 10 in 2.3.2 Supply current characteristics (3/3)		

Rev.	Date	Description			
		Page	Summary		
2.00	Jan 10, 2014	35	Modification of table in 2.4 AC Characteristics		
		36	Addition of Minimum Instruction Execution Time during Main System Clock Operation		
		37	Modification of AC Timing Test Points and External System Clock Timing		
		39	Modification of AC Timing Test Points		
		39	Modification of description, notes 1 and 2 in (1) During communication at same potential (UART mode)		
		41, 42	Modification of description, remark 2 in (2) During communication at same potential (CSI mode)		
		42, 43	Modification of description in (3) During communication at same potential (CSI mode)		
		45	Modification of description, notes 1 and 3, and remark 3 in (4) Communication at different potential (1.8 V, 2.5 V, 3 V) (UART mode) (1/2)		
		46, 48	Modification of description, and remark 3 in (4) Communication at different potential (1.8 V, 2.5 V, 3 V) (UART mode) (2/2)		
		49, 50	Modification of table, and note 1, caution, and remark 3 in (5) Communication at different potential (2.5 V, 3 V) (CSI mode)		
		51	Modification of table and note in (6) Communication at different potential (1.8 V, 2.5 V, 3 V) (1/3)		
		52	Modification of table and notes 1 to 3 in (6) Communication at different potential (1.8 V, 2.5 V, 3 V) (2/3)		
		53, 54	Modification of table, note 3, and remark 3 in (6) Communication at different potential (1.8 V, 2.5 V, 3 V) (3/3)		
		56	Modification of table in (7) Communication at different potential (1.8 V, 2.5 V, 3 V) (CSI mode) (1/2)		
		57	Modification of table in (7) Communication at different potential (1.8 V, 2.5 V, 3 V) (CSI mode) (2/2)		
		59, 60	Addition of (1) I ² C standard mode		
		61	Addition of (2) I ² C fast mode		
		62	Addition of (3) I ² C fast mode plus		
		63	Addition of table in 2.6.1 A/D converter characteristics		
		63, 64	Modification of description and notes 3 to 5 in 2.6.1 (1)		
		65	Modification of description, notes 3 and 4 in 2.6.1 (2)		
		66	Modification of description, notes 3 and 4 in 2.6.1 (3)		
		67	Modification of description, notes 3 and 4 in 2.6.1 (4)		
		67	Modification of the table in 2.6.2 Temperature sensor/internal reference voltage characteristics		
		68	Modification of the table and note in 2.6.3 POR circuit characteristics		
		70	Modification of the table of LVD Detection Voltage of Interrupt & Reset Mode		
		70	Modification from V _{DD} rise slope to Power supply voltage rising slope in 2.6.5 Supply voltage rise time		
		75	Modification of description in 2.10 Dedicated Flash Memory Programmer Communication (UART)		
		76	Modification of the figure in 2.11 Timing Specifications for Switching Flash Memory Programming Modes		
		77 to 126	Addition of products for industrial applications (G: T _A = -40 to +105°C)		
		127 to 133	Addition of product names for industrial applications (G: T _A = -40 to +105°C)		
		2.10	Sep 30, 2016	5	Modification of pin configuration in 1.3.1 32-pin products
				6	Modification of pin configuration in 1.3.2 44-pin products
7	Modification of pin configuration in 1.3.3 48-pin products				
8	Modification of pin configuration in 1.3.4 52-pin products				
9, 10	Modification of pin configuration in 1.3.5 64-pin products				
17	Modification of description of main system clock in 1.6 Outline of Functions				
74	Modification of title of 2.8 RAM Data Retention Characteristics, Note, and figure				
74	Modification of table of 2.9 Flash Memory Programming Characteristics				
123	Modification of title of 3.8 RAM Data Retention Characteristics, Note, and figure				
123	Modification of table of 3.9 Flash Memory Programming Characteristics and addition of Note 4				
131	Modification of 4.5 64-pin Products				

Rev.	Date	Description	
		Page	Summary
2.11	Feb 14, 2020	3	Addition of packaging specifications in Figure 1-1 Part Number, Memory Size, and Package of RL78/L12
		4, 5	Addition of ordering part numbers and RENESAS codes in Table 1-1 List of Ordering Part Numbers
		6 to 11	Additions of the package size and pin pitch in 1.3 Pin Configuration (Top View)
		126, 127, 129, 131 to 133, 135	Modification of the titles of the subchapters and deletion of product names in Chapter 4
		128	Addition of figure in 4.2 44-pin Package
		130	Addition of figure in 4.3 48-pin Package
		134	Addition of figure in 4.5 64-pin Package
2.12	Dec 22, 2020	3	Modification of Figure 1-1 Part Number, Memory Size, and Package of RL78/L12
		4	Modification of description in Table 1-1 List of Ordering Part Numbers
		135	Addition of figure in 4.5 64-pin Package

The mark “<R>” shows major revised points. The revised points can be easily searched by copying an “<R>” in the PDF file and specifying it in the “Find what:” field.

All trademarks and registered trademarks are the property of their respective owners.

SuperFlash is a registered trademark of Silicon Storage Technology, Inc. in several countries including the United States and Japan.

Caution: This product uses SuperFlash® technology licensed from Silicon Storage Technology, Inc.
--

General Precautions in the Handling of Microprocessing Unit and Microcontroller Unit Products

The following usage notes are applicable to all Microprocessing unit and Microcontroller unit products from Renesas. For detailed usage notes on the products covered by this document, refer to the relevant sections of the document as well as any technical updates that have been issued for the products.

1. Precaution against Electrostatic Discharge (ESD)

A strong electrical field, when exposed to a CMOS device, can cause destruction of the gate oxide and ultimately degrade the device operation. Steps must be taken to stop the generation of static electricity as much as possible, and quickly dissipate it when it occurs. Environmental control must be adequate. When it is dry, a humidifier should be used. This is recommended to avoid using insulators that can easily build up static electricity.

Semiconductor devices must be stored and transported in an anti-static container, static shielding bag or conductive material. All test and measurement tools including work benches and floors must be grounded. The operator must also be grounded using a wrist strap. Semiconductor devices must not be touched with bare hands. Similar precautions must be taken for printed circuit boards with mounted semiconductor devices.

2. Processing at power-on

The state of the product is undefined at the time when power is supplied. The states of internal circuits in the LSI are indeterminate and the states of register settings and pins are undefined at the time when power is supplied. In a finished product where the reset signal is applied to the external reset pin, the states of pins are not guaranteed from the time when power is supplied until the reset process is completed. In a similar way, the states of pins in a product that is reset by an on-chip power-on reset function are not guaranteed from the time when power is supplied until the power reaches the level at which resetting is specified.

3. Input of signal during power-off state

Do not input signals or an I/O pull-up power supply while the device is powered off. The current injection that results from input of such a signal or I/O pull-up power supply may cause malfunction and the abnormal current that passes in the device at this time may cause degradation of internal elements. Follow the guideline for input signal during power-off state as described in your product documentation.

4. Handling of unused pins

Handle unused pins in accordance with the directions given under handling of unused pins in the manual. The input pins of CMOS products are generally in the high-impedance state. In operation with an unused pin in the open-circuit state, extra electromagnetic noise is induced in the vicinity of the LSI, an associated shoot-through current flows internally, and malfunctions occur due to the false recognition of the pin state as an input signal become possible.

5. Clock signals

After applying a reset, only release the reset line after the operating clock signal becomes stable. When switching the clock signal during program execution, wait until the target clock signal is stabilized. When the clock signal is generated with an external resonator or from an external oscillator during a reset, ensure that the reset line is only released after full stabilization of the clock signal. Additionally, when switching to a clock signal produced with an external resonator or by an external oscillator while program execution is in progress, wait until the target clock signal is stable.

6. Voltage application waveform at input pin

Waveform distortion due to input noise or a reflected wave may cause malfunction. If the input of the CMOS device stays in the area between V_{IL} (Max.) and V_{IH} (Min.) due to noise, for example, the device may malfunction. Take care to prevent chattering noise from entering the device when the input level is fixed, and also in the transition period when the input level passes through the area between V_{IL} (Max.) and V_{IH} (Min.).

7. Prohibition of access to reserved addresses

Access to reserved addresses is prohibited. The reserved addresses are provided for possible future expansion of functions. Do not access these addresses as the correct operation of the LSI is not guaranteed.

8. Differences between products

Before changing from one product to another, for example to a product with a different part number, confirm that the change will not lead to problems. The characteristics of a microprocessing unit or microcontroller unit products in the same group but having a different part number might differ in terms of internal memory capacity, layout pattern, and other factors, which can affect the ranges of electrical characteristics, such as characteristic values, operating margins, immunity to noise, and amount of radiated noise. When changing to a product with a different part number, implement a system-evaluation test for the given product.

Notice

1. Descriptions of circuits, software and other related information in this document are provided only to illustrate the operation of semiconductor products and application examples. You are fully responsible for the incorporation or any other use of the circuits, software, and information in the design of your product or system. Renesas Electronics disclaims any and all liability for any losses and damages incurred by you or third parties arising from the use of these circuits, software, or information.
2. Renesas Electronics hereby expressly disclaims any warranties against and liability for infringement or any other claims involving patents, copyrights, or other intellectual property rights of third parties, by or arising from the use of Renesas Electronics products or technical information described in this document, including but not limited to, the product data, drawings, charts, programs, algorithms, and application examples.
3. No license, express, implied or otherwise, is granted hereby under any patents, copyrights or other intellectual property rights of Renesas Electronics or others.
4. You shall not alter, modify, copy, or reverse engineer any Renesas Electronics product, whether in whole or in part. Renesas Electronics disclaims any and all liability for any losses or damages incurred by you or third parties arising from such alteration, modification, copying or reverse engineering.
5. Renesas Electronics products are classified according to the following two quality grades: "Standard" and "High Quality". The intended applications for each Renesas Electronics product depends on the product's quality grade, as indicated below.
"Standard": Computers; office equipment; communications equipment; test and measurement equipment; audio and visual equipment; home electronic appliances; machine tools; personal electronic equipment; industrial robots; etc.
"High Quality": Transportation equipment (automobiles, trains, ships, etc.); traffic control (traffic lights); large-scale communication equipment; key financial terminal systems; safety control equipment; etc.
Unless expressly designated as a high reliability product or a product for harsh environments in a Renesas Electronics data sheet or other Renesas Electronics document, Renesas Electronics products are not intended or authorized for use in products or systems that may pose a direct threat to human life or bodily injury (artificial life support devices or systems; surgical implantations; etc.), or may cause serious property damage (space system; undersea repeaters; nuclear power control systems; aircraft control systems; key plant systems; military equipment; etc.). Renesas Electronics disclaims any and all liability for any damages or losses incurred by you or any third parties arising from the use of any Renesas Electronics product that is inconsistent with any Renesas Electronics data sheet, user's manual or other Renesas Electronics document.
6. When using Renesas Electronics products, refer to the latest product information (data sheets, user's manuals, application notes, "General Notes for Handling and Using Semiconductor Devices" in the reliability handbook, etc.), and ensure that usage conditions are within the ranges specified by Renesas Electronics with respect to maximum ratings, operating power supply voltage range, heat dissipation characteristics, installation, etc. Renesas Electronics disclaims any and all liability for any malfunctions, failure or accident arising out of the use of Renesas Electronics products outside of such specified ranges.
7. Although Renesas Electronics endeavors to improve the quality and reliability of Renesas Electronics products, semiconductor products have specific characteristics, such as the occurrence of failure at a certain rate and malfunctions under certain use conditions. Unless designated as a high reliability product or a product for harsh environments in a Renesas Electronics data sheet or other Renesas Electronics document, Renesas Electronics products are not subject to radiation resistance design. You are responsible for implementing safety measures to guard against the possibility of bodily injury, injury or damage caused by fire, and/or danger to the public in the event of a failure or malfunction of Renesas Electronics products, such as safety design for hardware and software, including but not limited to redundancy, fire control and malfunction prevention, appropriate treatment for aging degradation or any other appropriate measures. Because the evaluation of microcomputer software alone is very difficult and impractical, you are responsible for evaluating the safety of the final products or systems manufactured by you.
8. Please contact a Renesas Electronics sales office for details as to environmental matters such as the environmental compatibility of each Renesas Electronics product. You are responsible for carefully and sufficiently investigating applicable laws and regulations that regulate the inclusion or use of controlled substances, including without limitation, the EU RoHS Directive, and using Renesas Electronics products in compliance with all these applicable laws and regulations. Renesas Electronics disclaims any and all liability for damages or losses occurring as a result of your noncompliance with applicable laws and regulations.
9. Renesas Electronics products and technologies shall not be used for or incorporated into any products or systems whose manufacture, use, or sale is prohibited under any applicable domestic or foreign laws or regulations. You shall comply with any applicable export control laws and regulations promulgated and administered by the governments of any countries asserting jurisdiction over the parties or transactions.
10. It is the responsibility of the buyer or distributor of Renesas Electronics products, or any other party who distributes, disposes of, or otherwise sells or transfers the product to a third party, to notify such third party in advance of the contents and conditions set forth in this document.
11. This document shall not be reprinted, reproduced or duplicated in any form, in whole or in part, without prior written consent of Renesas Electronics.
12. Please contact a Renesas Electronics sales office if you have any questions regarding the information contained in this document or Renesas Electronics products.

(Note 1) "Renesas Electronics" as used in this document means Renesas Electronics Corporation and also includes its directly or indirectly controlled subsidiaries.

(Note 2) "Renesas Electronics product(s)" means any product developed or manufactured by or for Renesas Electronics.

(Rev.4.0-1 November 2017)



SALES OFFICES

Renesas Electronics Corporation

<http://www.renesas.com>

Refer to "<http://www.renesas.com/>" for the latest and detailed information.

Renesas Electronics Corporation

TOYOSU FORESIA, 3-2-24 Toyosu, Koto-ku, Tokyo 135-0061, Japan

Renesas Electronics America Inc. Milpitas Campus

1001 Murphy Ranch Road, Milpitas, CA 95035, U.S.A.

Tel: +1-408-432-8888, Fax: +1-408-434-5351

Renesas Electronics America Inc. San Jose Campus

6024 Silver Creek Valley Road, San Jose, CA 95138, USA

Tel: +1-408-284-8200, Fax: +1-408-284-2775

Renesas Electronics Canada Limited

9251 Yonge Street, Suite 8309 Richmond Hill, Ontario Canada L4C 9T3

Tel: +1-905-237-2004

Renesas Electronics Europe GmbH

Arcadiastrasse 10, 40472 Düsseldorf, Germany

Tel: +49-211-6503-0, Fax: +49-211-6503-1327

Renesas Electronics (China) Co., Ltd.

Room 101-T01, Floor 1, Building 7, Yard No. 7, 8th Street, Shangdi, Haidian District, Beijing 100085, China

Tel: +86-10-8235-1155, Fax: +86-10-8235-7679

Renesas Electronics (Shanghai) Co., Ltd.

Unit 301, Tower A, Central Towers, 555 Langao Road, Putuo District, Shanghai 200333, China

Tel: +86-21-2226-0888, Fax: +86-21-2226-0999

Renesas Electronics Hong Kong Limited

Unit 1601-1611, 16/F., Tower 2, Grand Century Place, 193 Prince Edward Road West, Mongkok, Kowloon, Hong Kong

Tel: +852-2265-6688, Fax: +852 2886-9022

Renesas Electronics Taiwan Co., Ltd.

13F, No. 363, Fu Shing North Road, Taipei 10543, Taiwan

Tel: +886-2-8175-9600, Fax: +886 2-8175-9670

Renesas Electronics Singapore Pte. Ltd.

80 Bendemeer Road, #06-02 Singapore 339949

Tel: +65-6213-0200, Fax: +65-6213-0300

Renesas Electronics Malaysia Sdn.Bhd.

Unit No 3A-1 Level 3A Tower 8 UOA Business Park, No 1 Jalan Pengerutcara U1/51A, Seksyen U1, 40150 Shah Alam, Selangor, Malaysia

Tel: +60-3-5022-1288, Fax: +60-3-5022-1290

Renesas Electronics India Pvt. Ltd.

No.77C, 100 Feet Road, HAL 2nd Stage, Indiranagar, Bangalore 560 038, India

Tel: +91-80-67208700

Renesas Electronics Korea Co., Ltd.

17F, KAMCO Yangjae Tower, 262, Gangnam-daero, Gangnam-gu, Seoul, 06265 Korea

Tel: +82-2-558-3737, Fax: +82-2-558-5338